

**John Deere
540D Skidder
548D Grapple Skidder
Repair**



TECHNICAL MANUAL

TM-1438 (Apr-88)

LITHO IN U.S.A.

Introduction

FOREWORD

This manual is written for an experienced technician. Essential tools required in performing certain service work are identified in this manual and are recommended for use.

Live with safety: Read the safety messages in the introduction of this manual and the cautions presented throughout the text of the manual.



This is the safety-alert symbol. When you see this symbol on the machine or in this manual, be alert to the potential for personal injury.

Technical manuals are divided in two parts: repair and diagnostics. Repair sections tell how to repair the components. Diagnostic sections help you identify the majority of routine failures quickly.

Information is organized in groups for the various components requiring service instruction. At the beginning of each group are summary listings of all applicable essential tools, service equipment and tools, other materials needed to do the job, service parts kits, specifications, wear tolerances, and torque values.

Binders, binder labels, and tab sets can be ordered by John Deere dealers direct from the John Deere Distribution Service Center.

This manual is part of a total product support program.

FOS Manuals-reference

Technical Manuals-machine service

Component Manuals-component service

Fundamentals of Service (FOS) Manuals cover basic theory of operation, fundamentals of troubleshooting, general maintenance, and basic types of failures and their causes. FOS Manuals are for training new personnel and for reference by experienced technicians.

Technical Manuals are concise guides for specific machines. Technical manuals are on-the-job guides containing only the vital information needed for diagnosis, analysis, testing, and repair.

Component Technical Manuals are concise service guides for specific components. Component technicals manuals are written as stand-alone manuals covering multiple machine applications.

JOHN DEERE DEALERS

IMPORTANT: Please remove this page and route through your service department.

This is a complete revision for TM-1438, 540D Skidder and 548D Grapple Skidder.

Binder and tabs from old manual may be saved and used with this bound manual.

The new pages are dated (Apr-88). Listed below is a brief explanation of "WHAT" was changed and "WHY" it was changed.

This manual was revised:

1. Inspection procedure group added in Section I.
2. Repair story for seals in oscillating support.
3. Cross section drawing of planetary pack added.
4. Engine repair story is removed. For complete repair information, see the component technical manual.
5. Repair story for new park brake seals and installation of seals with brake on unit.
6. Main pump repair story is removed. For complete repair information see the component technical manual.
7. Artwork for blade and grapple control valve revised to include external seal design for the spools.
8. Pressure control valve (priority valve) setting change to 8600 ± 345 kPa (85 ± 3.4 bar) (1250 ± 50 psi).
9. General updating.

<https://www.ebooklibonline.com>

Hello dear friend!

Thank you very much for reading.

Enter the link into your browser.

The full manual is available for immediate download.

<https://www.ebooklibonline.com>

**540D SKIDDER
548D GRAPPLE SKIDDER
TECHNICAL MANUAL
TM-1438 (APR-88)**

SECTION AND GROUP CONTENTS

NOTE: This manual covers repair. For operation and tests, see TM-1439, Operation and Tests.

SECTION I—GENERAL INFORMATION

- Group I—Safety Information
- Group II—General Specifications
- Group III—Torque Values
- Group IV—Fuels and Lubricants
- Group V—Inspection Procedure

SECTION 01—WHEELS

- Group 0110—Powered Wheels and Fastenings

SECTION 02—AXLES AND SUSPENSION SYSTEMS

- Group 0200—Removal and Installation
- Group 0210—Differential or Bevel Drive
- Group 0225—Input Drive Shafts and U-Joints
- Group 0250—Axle Shafts, Bearings and Reduction Gears
- Group 0260—Hydraulic System
 - Differential Lock Valve, Accumulator
 - Return Oil Screen, Air Assisted
 - Differential Lock Oil Return System

SECTION 03—TRANSMISSION

- Group 0300—Removal and Installation
- Group 0315—Controls Linkage
- Group 0350—Gears, Shafts, Bearings and Power Shift Clutch

SECTION 03—TRANSMISSION—Continued

- Group 0360—Hydraulic System
 - Suction Screen, Transmission Filter, Filter Relief Valve, Pressure Regulating Valve, Cooler Relief Valve, Oil Cooler, Transmission Control Valve C1-C2 Accumulator, and Oil Pump.

SECTION 04—ENGINE

- Group 0400—Removal and Installation

SECTION 05—ENGINE AUXILIARY SYSTEMS

- Group 0505—Cold Weather Starting Aids
- Group 0510—Cooling System
- Group 0515—Speed Controls
- Group 0520—Intake System
- Group 0530—External Exhaust System
- Group 0560—External Fuel Supply System

SECTION 07—DISCONNECT CLUTCH

- Group 0715—Controls Linkage
- Group 0752—Elements

Continued on next page

All information, illustrations and specifications contained in this technical manual are based on the latest information available at the time of publication. The right is reserved to make changes at any time without notice.

COPYRIGHT® 1988
DEERE & COMPANY
Moline, Illinois
All rights reserved
A John Deere ILLUSTRATION™ Manual
Previous Editions
Copyright® 1984, Deere & Company

T64;1438 M1 250588

SECTION 09—STEERING SYSTEM

- Group 0930—Secondary Steering
 - Check Valve, Pressure Switch,
 - Control Valve, Accumulator
- Group 0960—Hydraulic System
 - Steering Valve, Cylinders,
 - Port Mounted Crossover Relief Valve with Check Valve

SECTION 10—SERVICE BRAKES

- Group 1011—Active Elements
- Group 1060—Hydraulic System
 - Brake Valve, Accumulator

SECTION 11—PARK BRAKE

- Group 1111—Active Elements
- Group 1115—Controls Linkage
- Group 1160—Hydraulic System
 - Brake Valve, Accumulator,
 - Orifice

SECTION 16—ELECTRICAL SYSTEMS

- Group 1671—Batteries, Support and Cables
- Group 1672—Alternator, Regulator and Charging System Wiring
- Group 1673—Lighting System
- Group 1674—Wiring Harness and Switches
- Group 1676—Instruments and Indicators

SECTION 17—FRAME, CHASSIS, OR SUPPORTING STRUCTURE

- Group 1740—Frame Installation
 - Pivot Repair
- Group 1746—Frame Bottom Guards

SECTION 18—OPERATOR'S STATION

- Group 1800—Removal and Installation
- Group 1810—Operator Enclosure
 - Wiper Motor, Windshield Washer, and Windows
- Group 1821—Seat and Seat Belt
- Group 1830—Heating and Air Conditioning

SECTION 19—SHEET METAL AND STYLING

- Group 1910—Hood or Engine Enclosure
- Group 1921—Grille and Grille Housing

SECTION 20—SAFETY, CONVENIENCE AND MISCELLANEOUS

- Group 2004—Horn and Warning Devices

SECTION 21—MAIN HYDRAULIC SYSTEM

- Group 2160—Hydraulic System
 - Hydraulic Manifold (Surge Relief Valve, Priority Valve, System Relief Valve), Pump Drive, Filter, System Check Valve, Hydraulic System Oil Filter

SECTION 30—WINCH

- Group 3000—Removal and Installation
- Group 3050—Drive and Clutches
- Group 3060—Hydraulic System
 - Winch Valve, Winch Warm-Up Valve, Check Valve

SECTION 32—BULLDOZER (STACKING BLADE)

- Group 3200—Removal and Installation
- Group 3215—Controls Linkage
- Group 3260—Hydraulic System
 - Blade Valve, Cylinders

SECTION 37—ARCH OR BOOM

- Group 3740—Frames

SECTION 38—GRAPPLE

- Group 3803—Grapple Mechanism
- Group 3815—Controls Linkage
- Group 3840—Frames
- Group 3860—Hydraulic System
 - Grapple Valve, Crossover Relief Valve, Rotate Motor, Rotary Manifold, Grapple and Boom Cylinders

SECTION 40—PTO OR WINCH DRIVE

- Group 4025—Input Drive Shafts

SECTION 99—DEALER FABRICATED TOOLS

- Group 9900—Dealer Fabricated Tools

HANDLE FLUIDS SAFELY—AVOID FIRES

When you work around fuel, do not smoke or work near heaters or other fire hazards.

Store flammable fluids away from fire hazards. Do not incinerate or puncture pressurized containers.

Make sure machine is clean of trash, grease, and debris.

Do not store oily rags; they can ignite and burn spontaneously.



AB6;TS227 053;FLAME 050188

PREVENT BATTERY EXPLOSIONS

Keep sparks, lighted matches, and open flame away from the top of battery. Battery gas can explode.

Never check battery charge by placing a metal object across the posts. Use a volt-meter or hydrometer.

Do not charge a frozen battery; it may explode. Warm battery to 16°C (60°F).



ABT;TS204 053;SPARKS 050188

PREPARE FOR EMERGENCIES

Be prepared if a fire starts.

Keep a first aid kit and fire extinguisher handy.

Keep emergency numbers for doctors, ambulance service, hospital, and fire department near your telephone.

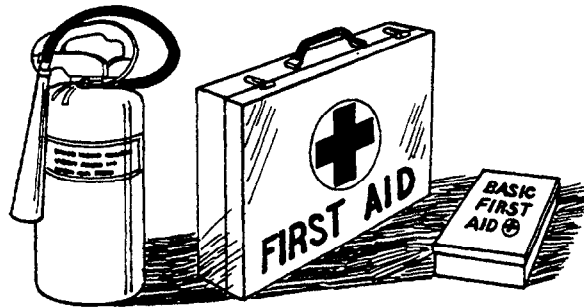

AB6;TS186 053;FIRE2 080785

PREVENT ACID BURNS

Sulfuric acid in battery electrolyte is poisonous. It is strong enough to burn skin, eat holes in clothing, and cause blindness if splashed into eyes.

Avoid the hazard by:

1. Filling batteries in a well-ventilated area.
2. Wearing eye protection and rubber gloves.
3. Avoiding breathing fumes when electrolyte is added.
4. Avoiding spilling or dripping electrolyte.
5. Use proper jump start procedure.

If you spill acid on yourself:

1. Flush your skin with water.
2. Apply baking soda or lime to help neutralize the acid.
3. Flush your eyes with water for 10-15 minutes. Get medical attention immediately.

If acid is swallowed:

1. Drink large amounts of water or milk.
2. Then drink milk of magnesia, beaten eggs, or vegetable oil.
3. Get medical attention immediately.

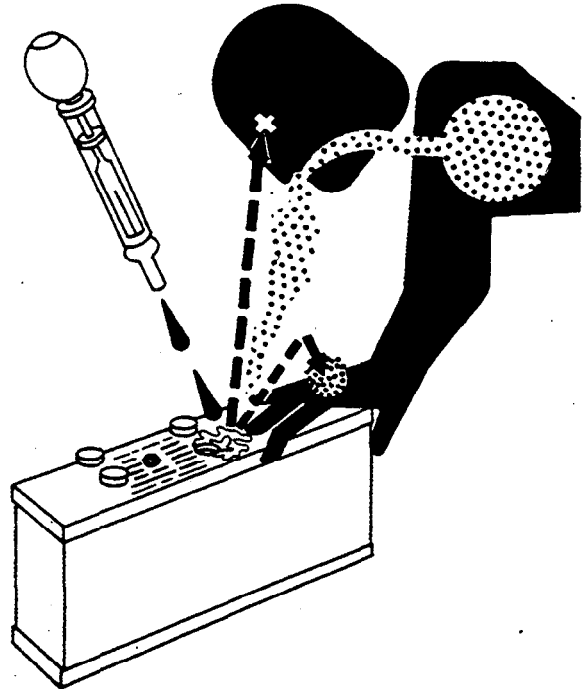

AB6;TS203 053;POISON 211287

AVOID HIGH-PRESSURE FLUIDS

Escaping fluid under pressure can penetrate the skin causing serious injury. Relieve pressure before unhooking hydraulic or other lines. Tighten all connections before applying pressure. Keep hands and body away from pinholes and nozzles which eject fluids under high pressure. Use a piece of cardboard to search for leaks.

If ANY fluid is injected into the skin, it must be surgically removed within a few hours by a doctor familiar with this type injury or gangrene may result.

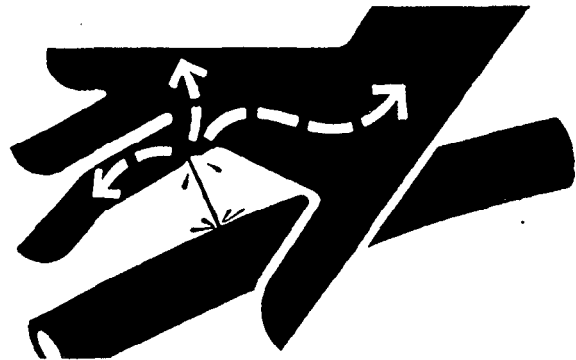

AB6;X9811 053;FLUID 180987

PARK MACHINE SAFELY

Before working on the machine:

- Lower all equipment to the ground.
- Stop the engine and remove the key.
- Disconnect the battery ground strap.
- Hang a "DO NOT OPERATE" tag in operator station.

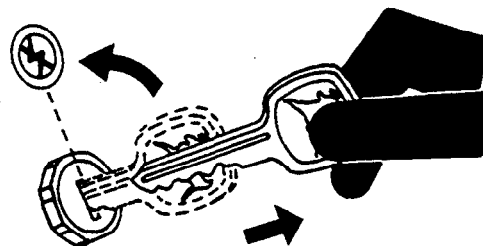

AB6;TS230 053;PARK 050188

SUPPORT MACHINE PROPERLY

Always lower the attachment or implement to the ground before you work on the machine. If you must work on a lifted machine or attachment, securely support the machine or attachment.

Do not support the machine on cinder blocks, hollow tiles, or props that may crumble under continuous load. Do not work under a machine that is supported solely by a jack. Follow recommended procedures in this manual.

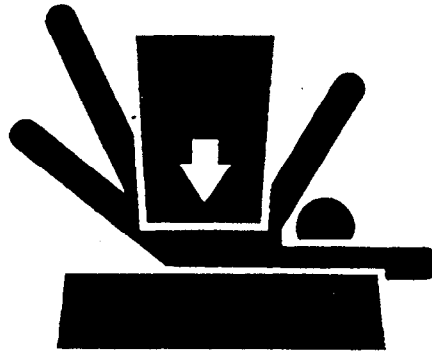

AB6;TS229 053;LOWER 211287

WEAR PROTECTIVE CLOTHING

Wear close fitting clothing and safety equipment appropriate to the job.

Prolonged exposure to loud noise can cause impairment or loss of hearing.

Wear a suitable hearing protective device such as earmuffs or earplugs to protect against objectionable or uncomfortable loud noises.

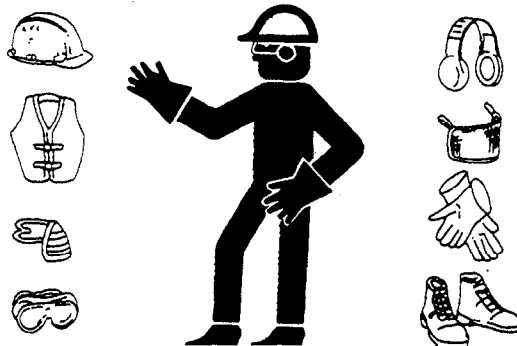

AB6;TS206 053;WEAR 230487

SERVICE MACHINE SAFELY

Tie long hair behind your head. Do not wear a necktie, scarf, loose clothing, or necklace when you work near machine tools or moving parts. If these items were to get caught, severe injury could result.

Remove rings and other jewelry to prevent electrical shorts and entanglement in moving parts.

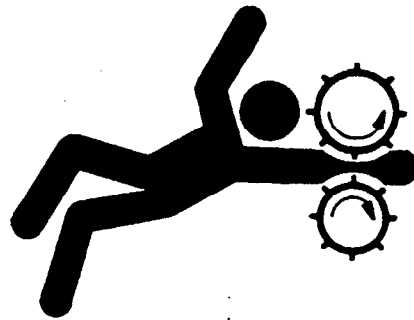

AB6;TS228 053;LOOSE 211287

WORK IN VENTILATED AREA

Engine exhaust fumes can cause sickness or death. If it is necessary to run an engine in an enclosed area, remove the exhaust fumes from the area with an exhaust pipe extension.

If you do not have an exhaust pipe extension, open the doors and get outside air into the area.

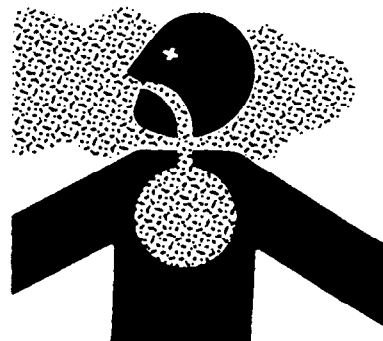

AB6;TS220 053;AIR 050188

UNDERSTAND CORRECT SERVICE

Illuminate your work area adequately but safely. Use a portable safety light for working inside or under the machine. Make sure the bulb is enclosed by a wire cage. The hot filament of an accidentally broken bulb can ignite spilled fuel or oil.

Catch draining fuel, oil, or other fluids in suitable containers. Do not use food or beverage containers that may mislead someone into drinking from them. Wipe up spills at once.

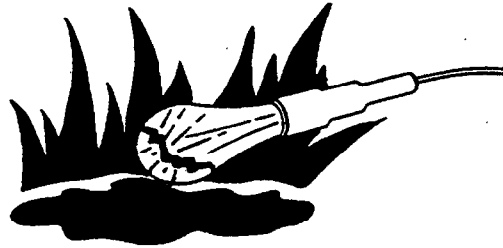

AB6;TS223 053;LIGHT 230288

REPLACE SAFETY SIGNS

Replace missing or damaged safety signs. See the machine operator's manual for correct safety sign placement.

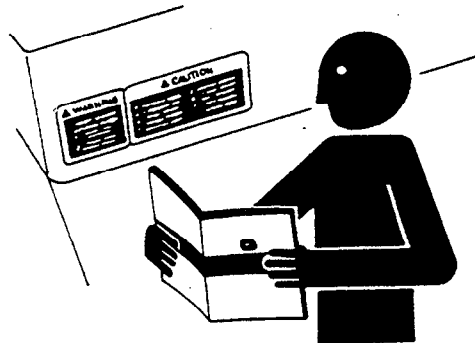

AB6;TS201 053;SIGNS1 221287

USE PROPER LIFTING EQUIPMENT

Lifting heavy components incorrectly can cause severe injury or machine damage.

Follow recommended procedure for removal and installation of components in the manual.

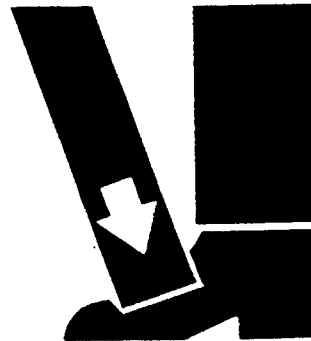

AB6;TS226 053;LIFT 050188

KEEP ROPS INSTALLED PROPERLY

Make certain all parts are reinstalled correctly if the roll-over protective structure (ROPS) is loosened or removed for any reason. Tighten mounting bolts to proper torque.

The protection offered by ROPS will be impaired if ROPS is subjected to structural damage, is involved in an overturn incident, or is in any way altered by welding, bending, drilling, or cutting. A damaged ROPS should be replaced, not reused.

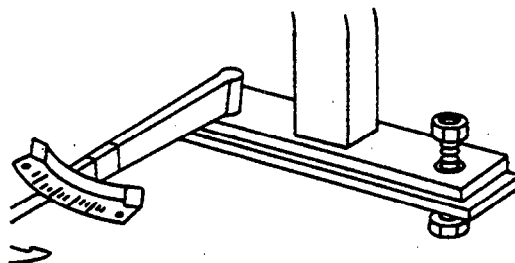

AB6;TS212 053;ROPS3 230487

SERVICE TIRES SAFELY

Explosive separation of a tire and rim parts can cause serious injury or death.

Do not attempt to mount a tire unless you have the proper equipment and experience to perform the job.

Always maintain the correct tire pressure. Do not inflate the tires above the recommended pressure.

When inflating tires, use a clip-on chuck and extension hose long enough to allow you to stand to one side and NOT in front of or over the tire assembly. Use a safety cage if available.

Check wheels for low pressure, cuts, bubbles, damaged rims or missing lug bolts and nuts.

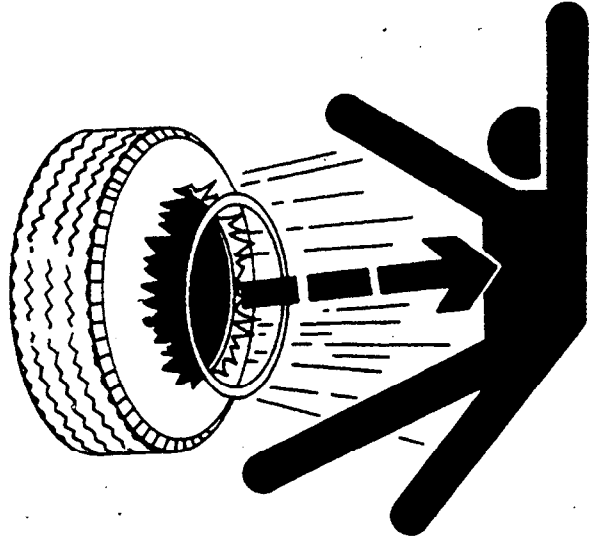

AB6;TS211 053;RIM 211287

AVOID HARMFUL ASBESTOS DUST

Avoid breathing dust that may be generated when handling components containing asbestos fibers. Inhaled asbestos fibers may cause lung cancer.

Components in John Deere products that may contain asbestos fibers are brake pads, brake band and lining assemblies, clutch plates, and some gaskets. The asbestos used in these components is usually found in a resin or sealed in some way. Normal handling is not hazardous as long as airborne dust containing asbestos is not generated.

Avoid creating dust. Never use compressed air for cleaning. Avoid brushing or grinding of asbestos containing materials. When servicing, wear an approved respirator. A special vacuum cleaner is recommended to clean asbestos. If not available, wet the asbestos containing materials with a mist of oil or water.

Keep bystanders away from the area.

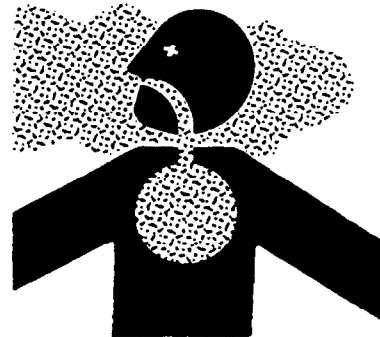

AB6;TS220 053;DUST 140488

WORK IN CLEAN AREA

Before starting a job:

- Clean work area and machine.
- Make sure you have all necessary tools to do your job.
- Have the right parts on hand.
- Read all instructions thoroughly; do not attempt shortcuts.

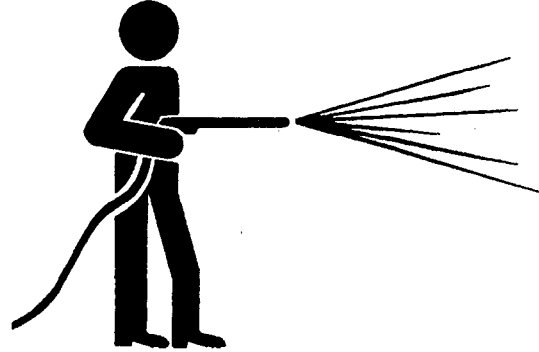

AB6;T6642E J 053;CLEAN 190188

USE TOOLS PROPERLY

Use tools appropriate to the work. Makeshift tools, parts, and procedures will not make good repairs.

Use pneumatic and electric tools only to loosen threaded parts and fasteners. Never use such tools to tighten fasteners, especially on light alloy parts.

Use only replacement parts meeting John Deere specifications.

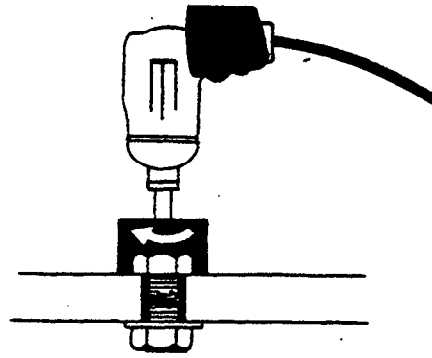

AB6;TS221 053;REPAIR 211287

DISPOSE FLUIDS PROPERLY

Be mindful of the environment and ecology. Before you drain fluids, find out the proper way to dispose of the oil.

Do not pour oil onto the ground, down a drain, or into a stream, pond, or lake. Consult local ordinances that govern the disposal of wastes.

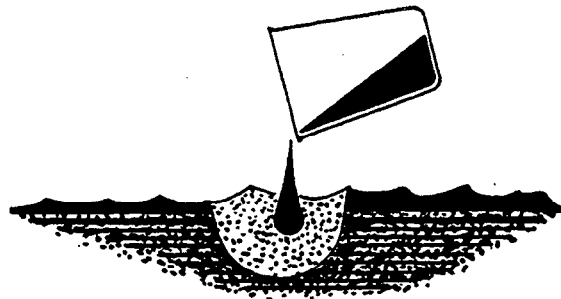

AB6;TS222 053;DRAIN 211287

LIVE WITH SAFETY

Before returning machine to customer, make sure machine is functioning properly, especially the safety systems. Install all guards and shields.



AB6;TS231 053;LIVE 050188

Group II General Specifications

540D SKIDDER

NOTE: Machine equipped with 18.4 x 26 tires and adjustable arch.

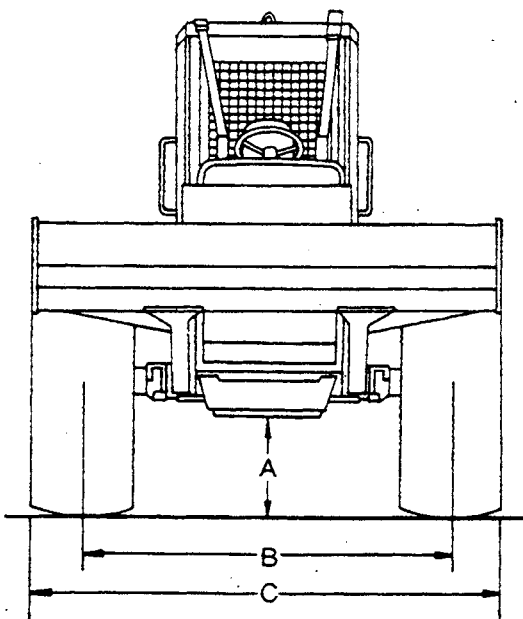
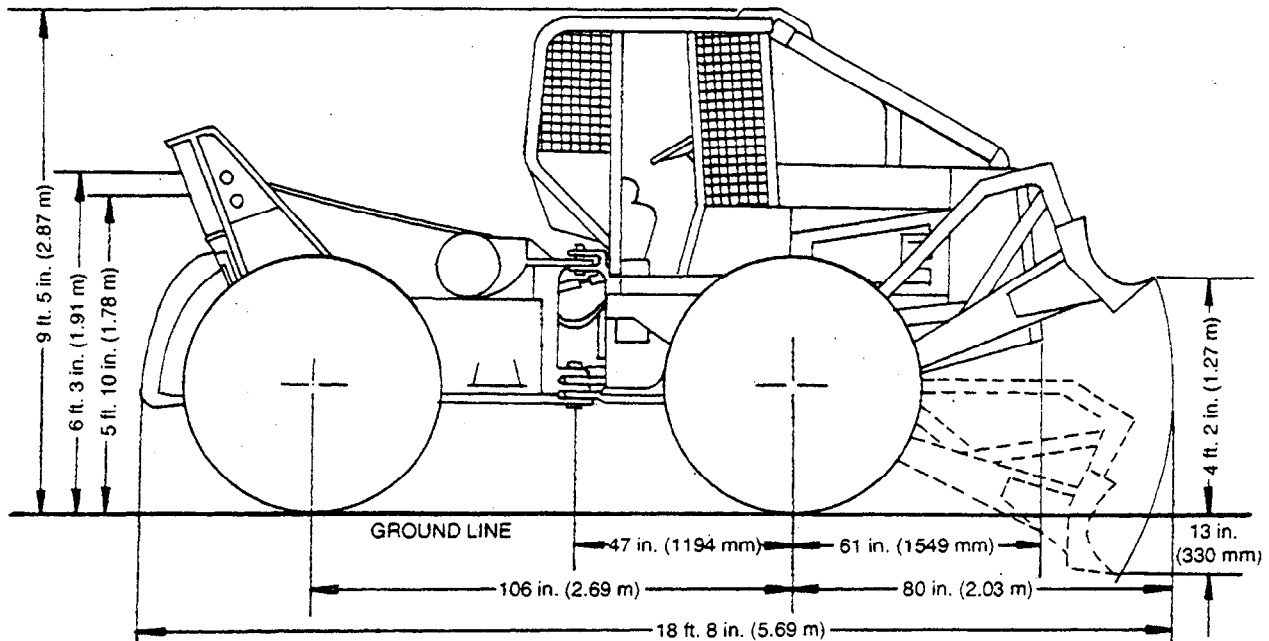

TIRE SIZE	A GROUND CLEARANCE	B WHEEL TREAD	C OVERALL WIDTH
18.4-26	1 ft. 6.5 in. (470 mm)	76 in. (1.93 m)	7 ft. 11 in. (2.41 m)
18.4-34	1 ft. 10 in. (559 mm)	76.6 in. (1.95 m)	7 ft. 11 in. (2.41 m)
23.1-26	1 ft. 9 in. (533 mm)	82.1 in. (2.09 m)	8 ft. 10 in. (2.69 m)
28L-26	1 ft. 9.5 in. (546 mm)	85.4 in. (2.17 m)	9 ft. 6 in. (2.90 m)

87A;T6793AE 05T;115 K61 120488

General Specifications

540D SKIDDER—CONTINUED

Specifications and design subject to change without notice. Wherever applicable, specifications are in accordance with SAE Standards. Except where otherwise noted, these specifications are based on a unit with 18.4-26, 10 PR tires, full fuel tank, 175-lb. (80 kg) operator and standard equipment.

Rated Power @ 2200 rpm:	SAE	DIN 70 020
Net	100 hp (75 kW)	75 kW
Gross	105 hp (78 kW)	

Net engine power is with standard equipment including air cleaner, exhaust system, alternator, and cooling fan, at standard conditions per SAE J1349 and DIN 70 020, using No.2-O fuel @ 35 API gravity. No derating is required up to 10,000 feet (3050 m) altitude. Gross power is without cooling fan.

Engine: John Deere 4-276T	
Type	4-stroke cycle, turbocharged diesel
Bore and stroke	4.19 x 5.00 in. (106.5 x 127 mm)
No. of cylinders	4
Displacement	276 cu. in. (4.524 L)
Maximum net torque @ 1300 rpm	290 lb-ft (393 Nm) (40 kg-m)
Cooling fan	Blower
Compression ratio	16.8 to 1
Lubrication	Pressure system w/full-flow filter
Electrical system	12-volt w/42 amp alternator
Battery	Reserve capacity: 180 minutes

Differentials:
Front and rear Full differentials w/hydraulic lock

Engine Clutch Disconnect:
Hand-operated, spring-loaded, dry disk. Single plate, 12 in. (305 mm).

Transmission:
Power Shift with planetary gears, hydraulically actuated wet-disk clutches and brakes; provides 8 speeds forward—4 reverse. Controlled by single lever on console.

Travel Speeds (2200 engine rpm, no tire slip):	mph	km/h
Forward	1.6-17.4	2.6-28.0
Reverse	2.1-5.8	3.4-9.3

Drive Axles:
Four-wheel drive with inboard planetary gears on all axles. Front axle oscillates 15 degrees above and below horizontal. Travel at tire center line 20 in. (508 mm).

Steering: Power
Articulated frame hydraulically actuated by two double-acting cylinders with cushioned stops. Steering system has hydraulic pressure priority.
Outside clearance circle w/o blade 34 ft. 4 in. (10.46 m)
Outside clearance circle w/blade 35 ft. 0 in. (10.67 m)

Brakes:
Service Hydraulic, power-actuated, pedal-controlled wet disk brakes located in axle.
Parking, winching and emergency stop Hand-operated mechanical wet-disk brake located on driveline for braking front and rear axles. Hydraulic release.

Hydraulic System:
Closed center, constant pressure. Variable-displacement pump driven from crankshaft 25 gpm (95 L/min), 2000 psi (13 790 kPa) (140.6 kg/cm²) @ 2200 engine rpm. Full-flow filtration. Oil-to-air cooler.

Hydraulic Cylinders:	Rod Dia.	Bore	Stroke
Blade lift cylinders (2)	1.50 in.	3.50 in.	14.25 in.
	(38.1 mm)	(89 mm)	(362 mm)
Steering cylinders (2)	1.75 in.	2.75 in.	14.37 in.
	(44.5 mm)	(70 mm)	(365 mm)

Cylinder rods are ground, heat-treated, chrome-plated and polished.

Blade: Hydraulic control	
Width	6 ft. 11 in. (2.11 m)
Max. lift above ground level	4 ft. 2 in. (1.27 m)
Max. drop below ground level	15 in. (330 mm)
Height (ends)	1 ft. 9 in. (533 mm)
Height (center)	2 ft. 3 in. (686 mm)

Cable Arch:	
Horizontal roller	6 in. (152 mm) dia.
Vertical rollers (through-hardened steel)	4.5 in. (114 mm) dia.
Working height settings (top of horizontal roller to ground):	
Lower	5 ft. 10 in. (1.78 m)
Upper	6 ft. 3 in. (1.91 m)

Winch:
Live mechanical drive; hydraulically actuated clutch and brakes, single lever control.
Winch capacities*
1/2-in. (12.7 mm) cable 223 ft. (68 m)
5/8-in. (15.8 mm) cable 146 ft. (45 m)
3/4-in. (19.1 mm) cable 103 ft. (31.4 m)
*Calculated—no allowance made for loose or uneven spooling.

Linepull:**
Bare drum 26,700 lb. (119 kN) (12 100 kg)
Full drum 18,100 lb. (81 kN) (8200 kg)
**Based on winch clutch capacity and .75 in. (19 mm) cable.

Line speed (2200 rpm) and .75 in. (19 mm) cable:
Bare drum 126 fpm (38.3 m/min)
Full drum 176 fpm (53.6 m/min)

Tires:
18.4-26, 10 PR, steel-ply, LS2
18.4-34, 10 PR, steel-ply, LS2
23.1-26, 10 PR, steel-ply, LS2
28L-26, 10 PR, steel-ply, LS2
28L-26, 10 PR, steel-ply, LS3

Capacities:	U.S.	Liters
Fuel tank	41 gal.	155.2
Cooling system	7.7 gal.	29.2
Engine lubrication, including filter	15 qt.	14.2
Transmission and hydraulic system	9 gal.	34.1
Front differential	4.5 gal.	17
Rear differential	4.5 gal.	17
Winch	1.8 gal.	6.8

SAE Operating Weight w/Blade 16,200 lb. (7348 kg)
SAE Operating Weight w/o Blade 14,970 lb. (6790 kg)

87A:T6793AF 05T:115 K62 120488

General Specifications

548D/7411 GRAPPLE SKIDDER

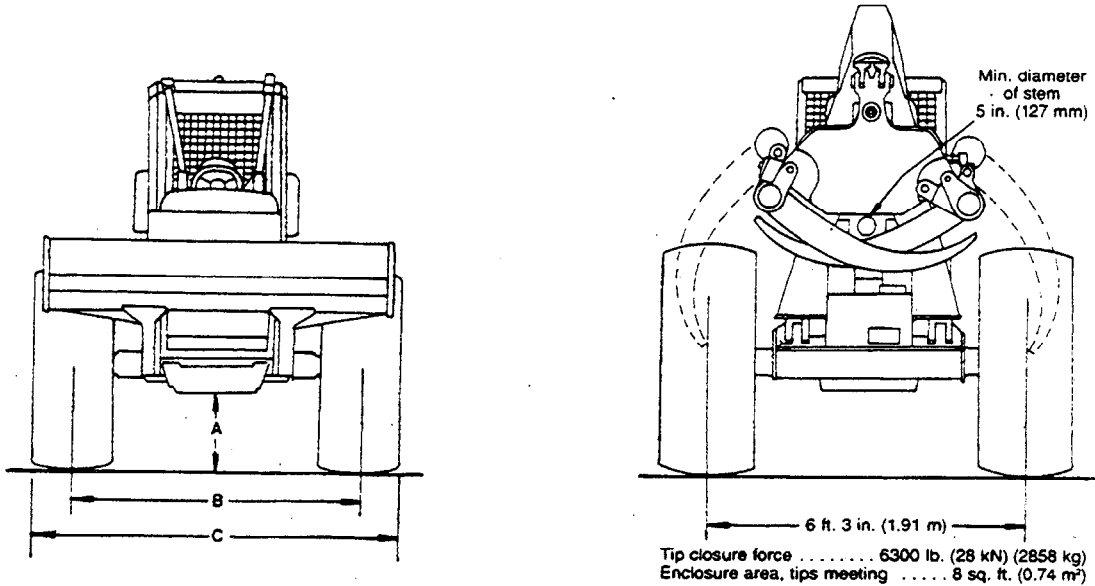
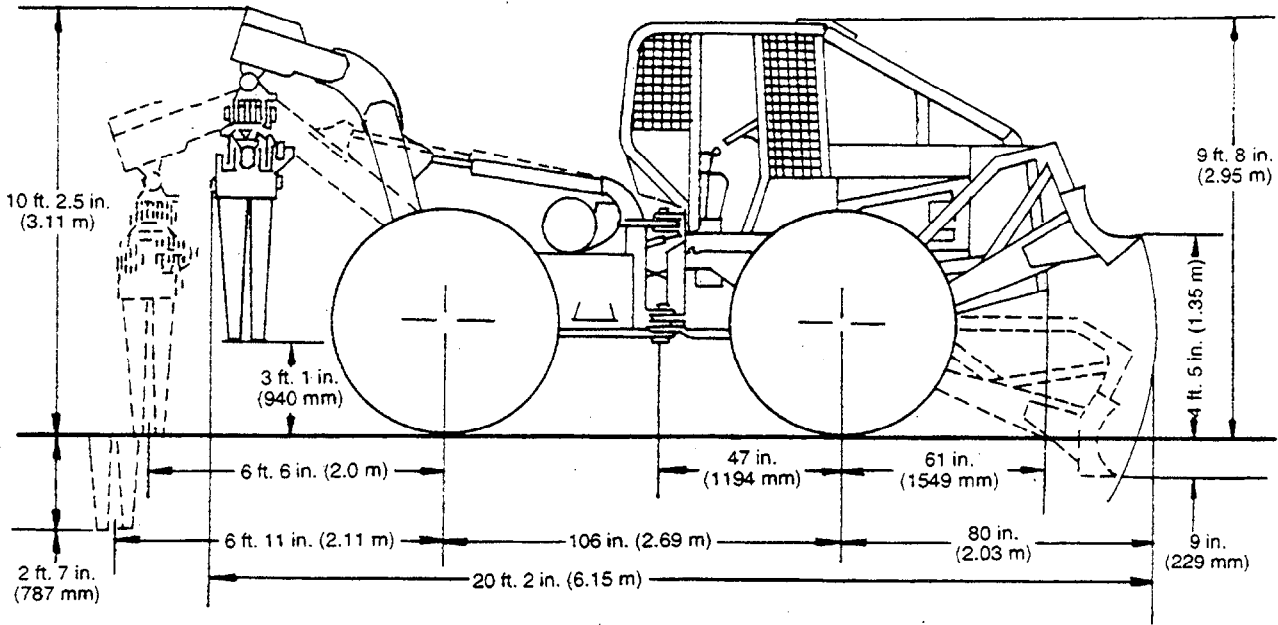

TIRE SIZE	A GROUND CLEARANCE	S3 SERIES AXLES		S4 SERIES AXLES	
		B WHEEL TREAD	C OVERALL WIDTH	B WHEEL TREAD	C OVERALL WIDTH
18.4-34	1 ft. 10 in. (559 mm)	76.6 in. (1.95 m)	7 ft. 11 in. (2.41 m)	N/A*	N/A
23.1-26	1 ft. 9 in. (533 mm)	80.8 in. (2.05 m)	8 ft. 9 in. (2.67 m)	80.2 in. (2.04 m)	8 ft. 8 in. (2.64 m)
28L-26	1 ft. 9.5 in. (546 mm)	N/A	N/A	87.5 in. (2.22 m)	9 ft. 8 in. (2.95 m)

* N/A= not available

NOTE: Machine equipped with 18.4 x 34 tires, grapple positioned with cylinders fully retracted and tongs tip to tip.

87A;T6793AD 05T;115 K63 220488

General Specifications

548D/7411 GRAPPLE SKIDDER—CONTINUED

Specifications and design are subject to change without notice. Wherever applicable, specifications are in accordance with SAE Standards. Except where otherwise noted, these specifications are based on a unit with 18.4-34, 10 PR tires, full fuel tank, 175-lb. (80 kg) operator and standard equipment.

Rated Power @ 2200 rpm:	SAE	DIN 70 020
Net	100 hp (75 kW)	75 kW
Gross	105 hp (78 kW)	

Net engine power is with standard equipment including air cleaner, exhaust system, alternator, and cooling fan, at standard conditions per SAE J1349 and DIN 70 020, using No.2-D fuel @ 35 API gravity. No derating is required up to 10,000 feet (3050 m) altitude. Gross power is without cooling fan.

Engine: John Deere 4-276T

Type	4-stroke cycle, turbocharged diesel
Bore and stroke	4.19 x 5.00 in. (106.5 x 127 mm)
No. of cylinders	4
Displacement	276 cu. in. (4.524 L)
Maximum net torque @ 1300 rpm	290 lb-ft (393 Nm) (40 kg-m)
Cooling fan	Blower
Compression ratio	16.8 to 1
Lubrication	Pressure system w/full-flow filter
Electrical system	12-volt w/42-amp alternator
Battery	Reserve capacity: 180 minutes

Differentials:

Front and rear Full differentials w/hydraulic lock

Engine Clutch Disconnect:

Hand-operated, spring-loaded, dry disk. Single plate, 12 in. (305 mm).

Transmission:

Power Shift with planetary gears, hydraulically actuated wet-disk clutches and brakes; provides 8 speeds forward—4 reverse. Controlled by single lever on console.

Travel Speeds (2200 engine rpm, no tire slip):

	mph	km/h
Forward	1.8-19.8	2.9-31.9
Reverse	2.3-6.6	3.7-10.6

Drive Axles:

Four-wheel drive with inboard planetary gears on all axles. Front axle oscillates 15 degrees above and below horizontal. Travel at tire center line 20 in. (508 mm).

Steering: Power

Articulated frame hydraulically actuated by two double-acting cylinders with cushioned stops. Steering system has hydraulic pressure priority.

Outside clearance circle w/o blade	34 ft. 4 in. (10.46 m)
Outside clearance circle w/blade	35 ft. 0 in. (10.67 m)

Brakes:

Service Hydraulic, power-actuated, pedal-controlled wet-disk brakes located in axle.

Parking, winching and emergency stop Hand-operated mechanical wet-disk brake located on driveline for braking front and rear axles. Hydraulic release.

Hydraulic System:

Closed center, constant pressure. Variable-displacement pump driven from crankshaft 25 gpm (95 L/min), 2000 psi (13 790 kPa) (140.6 kg/cm²) @ 2200 engine rpm. Full-flow filtration. Oil-to-air cooler.

Capacities:	U.S.	Liters
Fuel tank	41 gal.	155
Cooling system	7.7 gal.	29.2
Engine lubrication, including filter	15 qt.	14.2
Transmission and hydraulic system	16 gal.	60.6
Front differential	4.5 gal.	17
Rear differential	4.5 gal.	17
Winch	1.8 gal.	6.8

Blade: Hydraulic control

Width	6 ft. 11 in. (2.11 m)
Max. lift above ground level	4 ft. 5 in. (1.35 m)
Max. drop below ground level	9 in. (229 mm)
Height (ends)	1 ft. 9 in. (533 mm)
Height (center)	2 ft. 3 in. (686 mm)

Winch:

Live mechanical drive; hydraulically actuated clutch and brakes, single-lever control.

Winch capacities*

1/2-in. (12.7 mm) cable	223 ft. (68 m)
5/8-in. (15.8 mm) cable	146 ft. (45 m)
3/4-in. (19.1 mm) cable	103 ft. (31.4 m)

*Calculated—no allowance made for loose or uneven spooling.

Linepull:**

Bare drum	26,700 lb. (119 kN) (12 100 kg)
Full drum	18,100 lb. (81 kN) (8200 kg)

**Based on winch clutch capacity and .75 in. (19 mm) cable.

Line speed (2200 rpm) and .75 in. (19 mm) cable:

Bare drum	126 fpm (38.3 m/min)
Full drum	176 fpm (53.6 m/min)

Hydraulic Cylinders:	Rod Dia.	Bore	Stroke
Blade lift cylinders (2)	1.50 in. (38.1 mm)	3.50 in. (89 mm)	14.25 in. (362 mm)
Steering cylinders (2)	1.75 in. (44.5 mm)	2.75 in. (70 mm)	14.37 in. (365 mm)
Grapple boom cylinders (2)	2.00 in. (51 mm)	4.00 in. (102 mm)	29.8 in. (757 mm)
Grapple tong cylinder (1)	2.25 in. (57 mm)	5.25 in. (133 mm)	16.8 in. (427 mm)

Cylinder rods are ground, heat-treated, chrome-plated and polished.

Tires:

- 18.4-34, 10 PR, steel-ply, LS2
- 23.1-26, 10 PR, steel-ply, LS2
- 28L-26, 10 PR, steel-ply, LS2
- 28L-26, 10 PR, steel-ply, LS3

SAE Operating Weight w/Blade	18,040 lb. (8183 kg)
SAE Operating Weight w/o Blade	16,815 lb. (7627 kg)

HARDWARE TORQUE SPECIFICATIONS

Check cap screws and nuts to be sure they are tight. If hardware is loose, tighten to torque shown on the following charts unless a special torque is specified.

T82:SKMA AT 270286

TIGHTEN UPPER FRAME PIVOT PIN

Annually or every 1000 hours, tighten upper frame pivot pin nut (A) to 1000 lb-ft (1350 N·m).

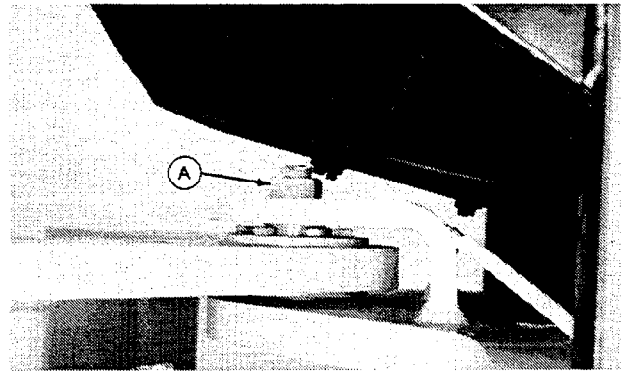

1TA:T5807BB T82:SKMA AR 230884

Torque Values

METRIC SERIES TORQUE CHART

CAUTION: Use only metric tools on metric hardware. Other tools may not fit properly. They may slip and cause injury.

















Check tightness of cap screws periodically. Torque values listed are for general use only. Do not use these values if a different torque value or tightening procedure is listed for a specific application.

Shear bolts are designed to fail under predetermined loads. Always replace shear bolts with identical grade.

Fasteners should be replaced with the same or higher grade. If higher grade fasteners are used, these should only be tightened to the strength of the original.

Make sure fastener threads are clean and you properly start thread engagement. This will prevent them from failing when tightening.

Tighten cap screws having lock nuts to approximately 50 percent of amount shown in chart.

Property Class	Head Markings	Property Class	Nut Markings
4.6	  No Mark	5	  No Mark
4.8	  No Mark		
8.8		8	 
9.8			
10.9		10	 
12.9		12	 

DIA.	WRENCH SIZE	4.6		4.8		8.8		9.8		10.9		12.9	
		OIL	DRY	OIL	DRY	OIL	DRY	OIL	DRY	OIL	DRY	OIL	DRY
		N·m(lb-ft)	N·m(lb-ft)	N·m(lb-ft)	N·m(lb-ft)	N·m(lb-ft)	N·m(lb-ft)	N·m(lb-in)	N·m(lb-in)	N·m(lb-ft)	N·m(lb-ft)	N·m(lb-ft)	N·m(lb-ft)
M5	8mm	1.5(1)	2.5(1.5)	2.5(1.5)	3.0(2)	4.5(3.5)	6.0(4.5)	5.0(3.5)	7.0(5)	6.5(4.5)	9.0(6.5)	7.5(5.5)	10.0(7.5)
M6	10mm	3.0(2)	4.0(3)	4.0(3)	5.5(4)	7.5(5.5)	10.0(7.5)	8.5(6)	12.0(9)	11.0(8)	15.0(11)	13.0(9.5)	18.0(13)
M8	13mm	7.0(5)	9.5(7)	10.0(7.5)	13.0(10)	18.0(13)	25(18)	21.0(15)	30(22)	25(18)	35(26)	30(22)	45(33)
M10	16mm	14.0(10)	19.0(14)	20.0(15)	25(18)	35(26)	50(37)	40(30)	55(41)	55(41)	75(55)	65(48)	85(63)
M12	18mm	25(18)	35(26)	35(26)	45(33)	65(48)	85(63)	70(52)	100(74)	95(70)	130(97)	110(81)	150(111)
M14	21mm	40(30)	50(37)	55(41)	75(55)	100(74)	140(103)	115(85)	155(114)	150(111)	205(151)	175(129)	240(177)
M16	24mm	60(44)	80(59)	85(63)	115(85)	160(118)	215(159)	180(133)	245(180)	235(173)	315(232)	275(203)	370(273)
M18	27mm	80(59)	110(81)	115(85)	160(118)	225(166)	305(225)			320(236)	435(321)	375(277)	510(376)
M20	30mm	115(85)	160(118)	165(122)	225(166)	320(236)	435(321)			455(356)	620(457)	535(395)	725(535)
M22	33mm	160(118)	215(159)	225(167)	305(225)	435(321)	590(435)			620(457)	840(620)	725(535)	985(726)
M24	36mm	200(148)	275(203)	285(210)	390(288)	555(409)	750(553)			790(583)	1070(789)	925(682)	1255(926)
M27	41mm	295(218)	400(295)	415(306)	565(417)	810(597)	1100(811)			1155(852)	1565(1154)	1350(996)	1835(1353)
M30	46mm	400(295)	545(402)	565(417)	770(568)	1100(811)	1495(1103)			1570(1158)	2130(1571)	1835(1353)	2490(1837)
M33	51mm	545(402)	740(546)	770(568)	1050(774)	1500(1106)	2035(1500)			2135(1575)	2900(2139)	2500(1844)	3390(2500)
M36	55mm	700(516)	950(700)	990(730)	1345(992)	1925(1420)	2610(1925)			2740(2021)	3720(2744)	3205(2364)	4355(3212)

AB6;TS234, TS235 053;TORQ4. 220188

Torque Values

INCH SERIES TORQUE CHART

Check tightness of cap screws periodically.









Torque values listed are for general use only. Do not use these values if a different torque value or tightening procedure is listed for a specific application.

Shear bolts are designed to fail under predetermined loads. Always replace shear bolts with identical grade.

Fasteners should be replaced with the same or higher grade. If higher grade fasteners are used, these should only be tightened to the strength of the original.

Make sure fastener threads are clean and you properly start thread engagement. This will prevent them from failing when tightening.

Tighten cap screws having lock nuts to approximately 50 percent of amount shown in chart.

SAE Grade	Head Markings	SAE Grade	Nut Markings
SAE GRADE 1 SAE GRADE 2	 No Mark	2	 No Mark
SAE GRADE 5 SAE GRADE 5.1 SAE GRADE 5.2	  	5	
SAE GRADE 8 SAE GRADE 8.2	 	8	

DIA.	WRENCH SIZE	SAE GRADE 1		SAE GRADE 2		SAE GRADE 5		SAE GRADE 8	
		OIL	DRY	OIL	DRY	OIL	DRY	OIL	DRY
		N-m(lb-in)	N-m(lb-in)	N-m(lb-in)	N-m(lb-in)	N-m(lb-in)	N-m(lb-in)	N-m(lb-in)	N-m(lb-in)
#6		0.5(4.5)	0.7(6)	0.8(7)	1(10)	1.4(12)	1.7(15)		
#8		0.9(8)	1.2(11)	1.5(13)	2(18)	2.4(21)	3.2(28)		
#10		1.4(12)	1.8(16)	2(19)	2.8(25)	3.4(30)	4.6(41)		
#12		2(19)	2.8(25)	3.4(30)	4.5(40)	5.4(48)	7.3(65)		
		N-m(lb-ft)	N-m(lb-ft)	N-m(lb-ft)	N-m(lb-ft)	N-m(lb-ft)	N-m(lb-ft)	N-m(lb-ft)	N-m(lb-ft)
1/4	7/16	3.5(2.5)	4(3.0)	5(4.0)	7(5.0)	8(6.0)	11(8.0)	12(8.5)	16(12)
5/16	1/2	7(5.0)	9(6.5)	10(7.5)	14(10.0)	16(12.0)	23(17.0)	24(18.0)	33(24)
3/8	9/16	12(8.5)	16(12.0)	19(14.0)	24(18.0)	30(22.0)	41(30)	41(30)	54(40)
7/16	5/8	19(14.0)	26(19.0)	30(22.0)	41(30)	47(35)	68(50)	68(50)	95(70)
1/2	3/4	24(21.0)	41(30)	47(35)	61(45)	75(55)	102(75)	102(75)	142(105)
9/16	13/16	41(30)	54(40)	68(50)	88(65)	108(80)	142(105)	149(110)	203(150)
5/8	15/16	54(40)	75(55)	88(65)	122(90)	149(110)	197(145)	203(150)	278(205)
3/4	1-1/8	102(75)	136(100)	163(120)	217(160)	258(190)	353(260)	366(270)	495(365)
7/8	1-5/16	163(120)	224(165)	163(120)	224(165)	414(305)	563(415)	590(435)	800(590)
1	1-1/2	244(180)	332(245)	244(180)	332(245)	624(460)	848(625)	881(650)	1193(880)
1-1/8	1-11/16	346(255)	468(345)	346(255)	468(345)	780(575)	1058(780)	1248(920)	1695(1250)
1-1/4	1-7/8	488(360)	664(490)	488(360)	665(490)	1098(810)	1492(1100)	1763(1300)	2393(1765)
1-3/8	2-1/16	637(470)	868(640)	637(470)	868(640)	1438(1061)	1953(1440)	2312(1705)	3140(2315)
1-1/2	2-1/4	848(625)	1153(850)	848(625)	1153(850)	1912(1410)	2590(1910)	3065(2260)	4163(3070)

AB6;TS236, TS237 053;TORQ3. 220188

KEEP ROPS INSTALLED PROPERLY

CAUTION: Make certain all parts are reinstalled correctly if the roll-over protective structure (ROPS) is loosened or removed for any reason. Tighten mounting bolts (A) to proper torque.

The protection offered by ROPS will be impaired if ROPS is subjected to structural damage, is involved in an overturn incident, or is in any way altered. A damaged ROPS should be replaced, not reused.

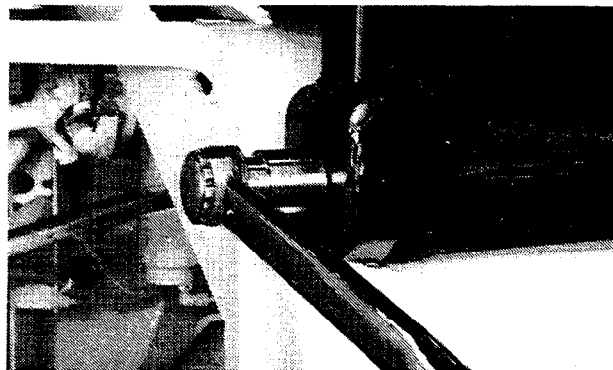

SPECIFICATION

ROPS mounting bolts torque 70—150 ft-lb (95—203 N·m)
Limb risers to canopy 70—150 ft-lb (95—203 N·m)

When installation of equipment on a machine requires loosening or removing Roll-Over Protective Structure, mounting bolts must be tightened.

1TA;T5804AT 04T;90 K148. 090588

SERVICE RECOMMENDATIONS FOR O-RING BOSS FITTINGS

Straight Fitting

1. Inspect O-ring boss seat for dirt or defects.
2. Lubricate O-ring with petroleum jelly. Place electrical tape over threads to protect O-ring. Slide O-ring over tape and into O-ring groove of fitting. Remove tape.
3. Tighten fitting to torque value shown on chart.

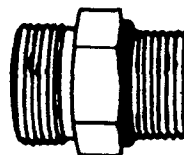

Angle Fitting

1. Back-off lock nut (A) and back-up washer (B) completely to head-end (C) of fitting.
2. Turn fitting into threaded boss until back-up washer (B) contacts face of boss.
3. Turn fitting head-end (C) counterclockwise to proper index (maximum of one turn).
4. Hold fitting head-end (C) with a wrench and tighten locknut (A) and back-up washer (B) to proper torque value.

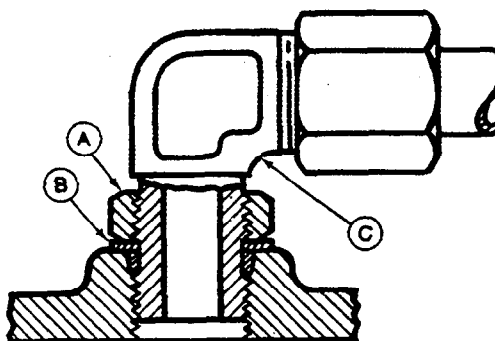

NOTE: Do not allow hoses to twist when tightening fittings.

TORQUE VALUE CHART

Thread Size	Torque	
	N·m	(lb-ft)
3/8-24 UNF	8	(6)
7/16-20 UNF	12	(9)
1/2-20 UNF	16	(12)
9/16-18 UNF	24	(18)
3/4-16 UNF	46	(34)
7/8-14 UNF	62	(46)
1-1/16-12 UN	102	(75)
1-3/16-12 UN	122	(90)
1-5/16-12 UN	142	(105)
1-5/8-12 UN	190	(140)
1-7/8-12 UN	217	(160)

NOTE: Torque tolerance is $\pm 10\%$.

SERVICE RECOMMENDATIONS FOR FLAT FACE O-RING SEAL FITTINGS

1. Inspect the fitting sealing surfaces. They must be free of dirt or defects.
2. Inspect the O-ring. It must be free of damage or defects.
3. Lubricate O-rings and install into groove using petroleum jelly to hold in place.
4. Push O-ring into the groove with plenty of petroleum jelly so O-ring is not displaced during assembly.
5. Index angle fittings and tighten by hand pressing joint together to insure O-ring remains in place.
6. Tighten fitting or nut to torque value shown on the chart per dash size stamped on the fitting. Do not allow hoses to twist when tightening fittings.

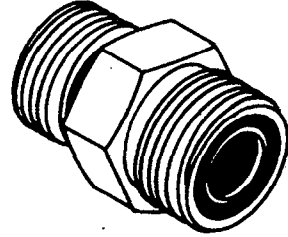

FLAT FACE O-RING SEAL FITTING TORQUE

Nominal Tube mm	O.D. (in.)	Dash Size	Thread Size in.	Swivel Nut Torque		Bulkhead Nut Torque	
				Nm	(lb-ft)	Nm	(lb-ft)
6.35	0.250	-4	9/16-18	16	12	5.0	3.5
9.52	0.375	-6	11/16-16	24	18	9.0	6.5
12.70	0.500	-8	13/16-16	50	37	17.0	12.5
15.88	0.625	-10	1-14	69	51	17.0	12.5
19.05	0.750	-12	1 3/16-12	102	75	17.0	12.5
22.22	0.875	-14	1 3/16-12	102	75	17.0	12.5
25.40	1.000	-16	1 7/16-12	142	105	17.0	12.5
31.75	1.250	-20	1 11/16-12	190	140	17.0	12.5
38.10	1.500	-24	2-12	217	160	17.0	12.5

NOTE: Torque tolerance is +15 -20%.

SAE FOUR BOLT FLANGE FITTING SERVICE RECOMMENDATIONS

1. Inspect the sealing surfaces for nicks or scratches, roughness or out-of-flat condition. Scratches cause leaks. Roughness causes seal wear. Out-of-flat causes seal extrusion. If these defects cannot be polished out, replace the component.

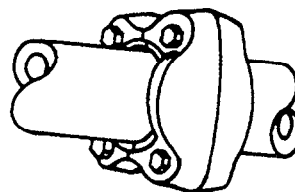

2. Install the correct O-ring (and backup washer if required) into the groove using petroleum jelly to hold it in place.

3. For split flange; loosely assemble split flange halves, being sure that the split is centrally located and perpendicular to the port. Hand tighten cap screws to hold parts in place. Do not pinch O-ring.

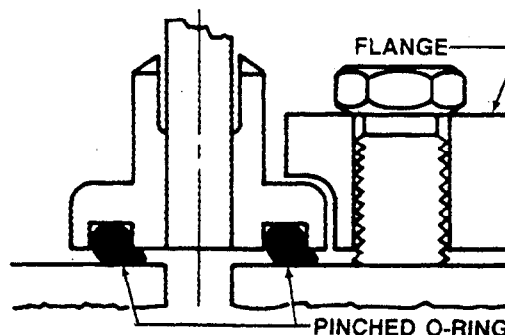

4. For single piece flange; put hydraulic line in the center of the flange and install four cap screws. With the flange centrally located on the port, hand tighten cap screws to hold it in place. Do not pinch O-ring.

5. For both single piece flange and split flange, be sure the components are properly positioned and cap screws are hand tight. Tighten one cap screw, then tighten the diagonally opposite cap screw. Tighten the two remaining cap screws. Tighten all cap screws within the specified limits shown in the chart.

DO NOT use air wrenches. DO NOT tighten one cap screw fully before tightening the others. DO NOT overtighten.

SAE FOUR BOLT FLANGE FITTING TORQUE

Nominal Flange Size	Cap Screw Size ¹	Torque ²			
		N·m		(lb-ft)	
		Min.	Max.	Min.	Max.
1/2	5/16 - 18 UNC	20	31	(15)	(23)
3/4	3/8 - 16 UNC	28	54	(21)	(40)
	M10 10.9	58	88	(43)	(65)
1	3/8 - 16 UNC	37	54	(27)	(40)
	M12 10.9	104	156	(77)	(115)
1-1/4	7/16 - 14 UNC	47	85	(35)	(63)
1-1/2	1/2 - 13 UNC	62	131	(46)	(97)
2	1/2 - 13 UNC	73	131	(54)	(97)
2-1/2	1/2 - 13 UNC	107	131	(79)	(97)
3	5/8 - 11 UNC	158	264	(117)	(195)
3-1/2	5/8 - 11 UNC	158	264	(117)	(195)
4	5/8 - 11 UNC	158	264	(117)	(195)
5	5/8 - 11 UNC	158	264	(117)	(195)

1. SAE Grade 5 or better cap screws with plated hardware.

2. Tolerance $\pm 10\%$. The torques given are enough for the given size connection with the recommended working pressure. Torques can be increased to the maximum shown for each cap screw size if desired. Increasing cap screw torque beyond this maximum will result in flange and cap screw bending and connection failures.

018;T6575AG, T6561AG 04T;90 K68. 251187

Torque Values

Group IV Fuels and Lubricants

FUEL SPECIFICATIONS

Use ONLY clean, high-quality fuel.

Use Grade No. 2-D fuel above 4°C (40°F).

Use Grade No. 1-D fuel below 4°C (40°F).

Use Grade No. 1-D fuel for all air temperatures at altitudes above 1 500 m (5000 ft).

IMPORTANT: If fuel sulfur content exceeds 0.5 per cent, change the engine oil at one-half the normal interval.

Use fuel with less than 1.0 per cent sulfur. If possible, use fuel with less than 0.5 per cent sulfur.

For maximum filter life, sediment and water should not be more than 0.10 per cent.

The cetane number should be 40 minimum. If you operate your machine where air temperatures are normally low or where altitudes are high, you may need fuel with a higher cetane number.

Cloud Point—For cold weather operation, cloud point should be 6°C (10°F) below lowest normal air temperature.

02T;45 C25. 020487

FUEL STORAGE

NOTE: Diesel fuels stored for a long time may form gum or bacteria and plug filters.

Keep fuel in a clean container in a protected area. Water and sediment must be removed before fuel gets to the engine. Do not use de-icers to remove water from fuel. Do not depend on fuel filters to remove water.

If possible, install a water separator at the storage tank outlet. (See your John Deere dealer).

IMPORTANT: Keep all dirt, scale, water or other foreign material out of fuel.

Store fuel drums on their sides.

02T;45 K8. 180387

FUEL TANK



CAUTION: Handle fuel carefully. If the engine is hot or running, do not fill the fuel tank. Do not smoke while you fill fuel tank or work on fuel system.

To avoid condensation, fill the fuel tank at the end of each day's operation. Capacity is 41 gal (155.8 L).



AB6;TS185 02T;45 K36. 140388

ENGINE OIL

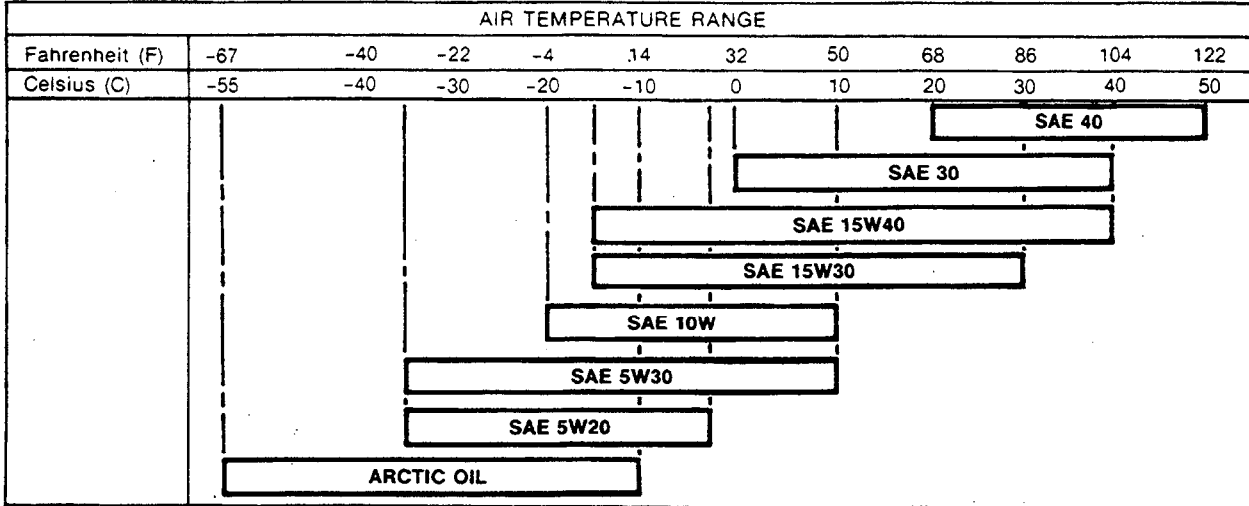

Depending upon the expected air temperature range between oil changes, use oil viscosity shown on the temperature chart above.

Additives are not required nor recommended.

John Deere TORQ-GARD SUPREME® engine oil is recommended because it is a specifically balanced formulation to provide maximum engine life. It provides excellent protection against mechanical wear, carbon deposits, and lacquer formation, plus providing superior cold weather starting performance.

If other oils are used, they must have one of the following specifications:

Oil Specification	Use
API Service: CD/SF, CD/SE, CD/SD, CD/SC, or MIL-L-2104C, MIL-L-2104D	Recommended

*API Service CC/SF, CC/SE, CC/SD, CC/SC or *MIL-L-46152, *MIL-L-46152B	For SAE 5W20, SAE 5W30 and arctic oil only, use if recommended oil is not available.
--	--

*MIL-L-46167A	For arctic oil only
---------------	---------------------

**Change oil at one-half the normal interval.*

018;T6172AJ 02T;45 K22. 301187

GREASE

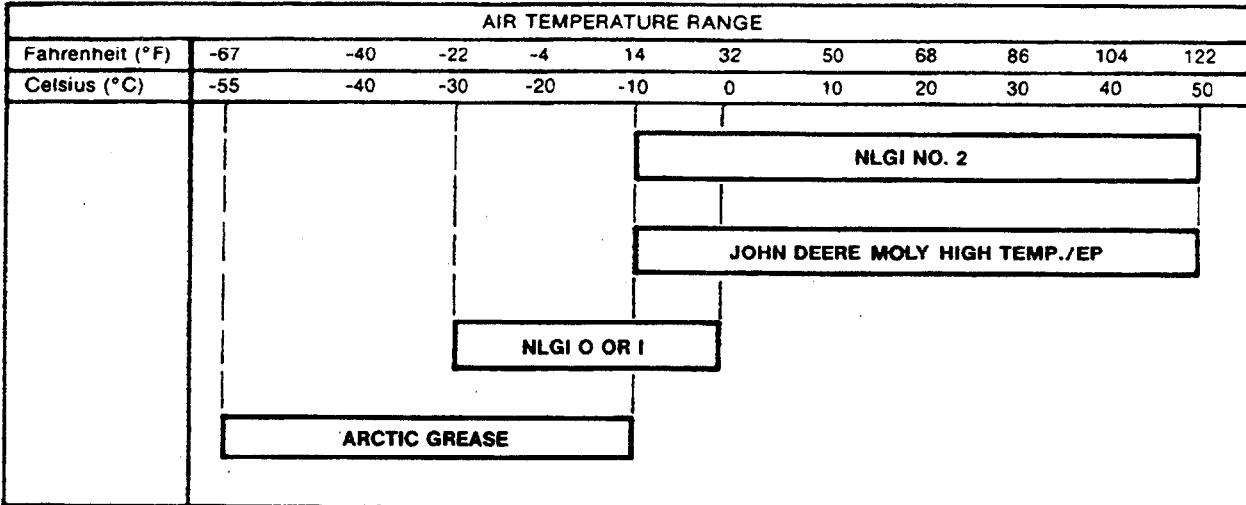

Depending on the expected air temperature range during use, use grease shown on chart above.

Greases recommended are:

John Deere Moly High Temperature/EP grease (preferred)

SAE Multipurpose Grease with Extreme Pressure (EP) performance and containing 3 to 5 per cent molybdenum disulfide (preferred).

SAE multi-purpose EP grease.

Grease meeting MIL-G-10924C specifications may be used as arctic grease.

018:T6722AA 02T:45 C49. 270188

LUBRICANT STORAGE

Your machine can operate at top efficiency only if clean lubricants are used. Use clean containers to handle all lubricants. Store them in an area protected from dust, moisture, and other contamination. Store drums on their sides.

T62:BHFL J. 230387

ALTERNATIVE LUBRICANTS

Additional information on cold weather operation is available from your John Deere dealer.

Conditions in certain geographical areas may require special lubricants and lubrication practices which do not appear in this operator's manual. If you have any questions, consult your John Deere dealer to obtain the latest information and recommendations.

053;ALTER. 050886

Fuels and Lubricants

PREDELIVERY INSPECTION (PDI)

Do the predelivery services shown on the inspection checklist before you deliver the machine to the customer. The checklist is in the back of the Operator's Manual

06T;PIM C1 090586

AFTER-SALE INSPECTION (ASI)

Do the after-sale services shown on the inspection checklist during the warranty period after 50—100 hours of machine operation. The after-sale checks are also found on the inspection checklist in the back of the Operator's Manual

Terms of this inspection are outlined on the customers John Deere Delivery Receipt.

06T;PIM C2 090586

PLANNED INSPECTION PROGRAM I (PIP I)

When you deliver the machine, explain to the customer the advantages of the Planned Inspection Program I (PIP I):

- Top production from the machine
- Minimum downtime
- Lower long-term operating costs
- Overall greater satisfaction

Prepare a contract with the customer specifying the number of field inspections by your service technician and the cost.

Use the PIP I Inspection Checklists in this group as a guide in preparing the contract.

06T;PIM C3 140486

PLANNED INSPECTION PROGRAM II (PIP II)

PIP II is a continuation of PIP I.

This program tests critical machine systems and will enable the customer to keep the machine in the best possible condition.

Prepare a contract with the customer specifying the number of field inspections by your service technician and the cost. Use the PIP II Inspection Checklist in this group as a guide in preparing the contract.

06T;PIM C4 090586

Inspection Procedures

USING THE CHECKLISTS

Do an inspection procedure only if there is a "box" behind the procedure in the service column which you are following. Mark the box with an "x" when the procedure is done.

For specific instructions on how to do each procedure, refer to the operator's manual or the technical manual.

If a box is not marked, write an explanation in the comments column. For example:

If engine oil level is low, note amount of oil needed to fill crankcase.

If the machine is not lubricated according to the Periodic Maintenance Chart, note this.

When the inspection is done, put the checklist in the customer's file. Use the same checklist for additional inspections.

06T;PIM C5 120586

DELIVERY SERVICE

Use the operator's manual as a guide. Discuss the following points thoroughly with the customer:

The importance of safety.

Controls and instruments.

All functions of the hydraulic system.

How to start and stop the engine.

The importance of the break-in period.

The importance of lubrication and periodic maintenance.

Have the owner sign the Delivery Receipt.

Give the owner the operator's manual.

T82;TLPO P 040187



JOHN DEERE 540D SKIDDER AND 548D GRAPPLE SKIDDER

CHECK LIST FOR PLANNED INSPECTION PROGRAM I (PIP I) — Field inspections contracted with the owner.

NOTE: Illustrated planned inspection program checks can be found in SP600.

	Inspection 1	Inspection 2	Inspection 3	Inspection 4
Machine Hours	_____	_____	_____	_____
Performed by	_____	_____	_____	_____
Mechanic Signature	_____	_____	_____	_____
Date	_____	_____	_____	_____
Owner's Name	_____	_____	_____	_____
Address	_____	_____	_____	_____
Signature	_____	_____	_____	_____
Dealership	_____	_____	_____	_____

NOTE: Do not remove these pages. Make photocopies for extra copies.

Item	OK	Comments
1. Coolant level and Coolant freeze protection	<input type="checkbox"/>	_____
2. Check radiator area	<input type="checkbox"/>	_____
3. Belt tension	<input type="checkbox"/>	_____
4. Clean engine compartment	<input type="checkbox"/>	_____
5. Check exhaust system	<input type="checkbox"/>	_____
6. Engine oil level	<input type="checkbox"/>	_____

Insert for OM-T77568 (H4)

1TA;T5855AT T82;SKPD FS 100584

Inspection Procedures

Item	OK	Comments
7. Engine oil condition	<input type="checkbox"/>	_____
8. Fuel filter	<input type="checkbox"/>	_____
9. Fuel tank sump	<input type="checkbox"/>	_____
10. Fuel tank filler screen	<input type="checkbox"/>	_____
11. Grapple damper	<input type="checkbox"/>	_____
12. Transmission-hydraulic oil level	<input type="checkbox"/>	_____
13. Transmission-hydraulic oil condition	<input type="checkbox"/>	_____
14. Winch oil level	<input type="checkbox"/>	_____
15. Winch oil condition	<input type="checkbox"/>	_____
16. Battery level and terminals	<input type="checkbox"/>	_____
17. Battery electrolyte concentration	<input type="checkbox"/>	_____
18. Air intake hose	<input type="checkbox"/>	_____
19. Air restriction indicator	<input type="checkbox"/>	_____
20. Start aid line	<input type="checkbox"/>	_____
21. Tire pressure	<input type="checkbox"/>	_____
22. Wheel cap screw torque	<input type="checkbox"/>	_____
23. Safety equipment and welds	<input type="checkbox"/>	_____
24. Seat operation	<input type="checkbox"/>	_____
25. Engine disconnect clutch	<input type="checkbox"/>	_____
26. Neutral start system	<input type="checkbox"/>	_____
27. Park brake oil level	<input type="checkbox"/>	_____
28. Lubricate grease fittings	<input type="checkbox"/>	_____
29. Check instruments	<input type="checkbox"/>	_____
30. Engine speeds	<input type="checkbox"/>	_____
31. Speed control linkage	<input type="checkbox"/>	_____
32. Transmission operation	<input type="checkbox"/>	_____

Insert for OM-T77568 (H4)

T82;SKPD FT 100584

Inspection Procedures

Item	OK	Comments
33. Steering operation	<input type="checkbox"/>	_____
34. Differential lock	<input type="checkbox"/>	_____
35. Service brake	<input type="checkbox"/>	_____
36. Parking brake	<input type="checkbox"/>	_____
37. Stacking blade	<input type="checkbox"/>	_____
38. Winch	<input type="checkbox"/>	_____
39. Operating light switch	<input type="checkbox"/>	_____
40. Cycle times	<input type="checkbox"/>	_____
41. Turbocharger	<input type="checkbox"/>	_____
42. Engine oil change	<input type="checkbox"/>	_____
43. Engine oil filter charge	<input type="checkbox"/>	_____
44. Transmission filter element	<input type="checkbox"/>	_____
45. Hydraulic filter element	<input type="checkbox"/>	_____
46. Park brake oil	<input type="checkbox"/>	_____
47. Fuel filter	<input type="checkbox"/>	_____
48. Differential oil	<input type="checkbox"/>	_____
49. Transmission-hydraulic system oil	<input type="checkbox"/>	_____
50. Winch oil	<input type="checkbox"/>	_____
51. Crankcase ventilation tube	<input type="checkbox"/>	_____
52. Clean machine	<input type="checkbox"/>	_____
53. Fluid leakage	<input type="checkbox"/>	_____
54. Air flow pre-test	<input type="checkbox"/>	_____
55. Air flow test	<input type="checkbox"/>	_____
56. Hardware torque	<input type="checkbox"/>	_____
Insert for OM-T77568 (H4)		

T82:SKPD FU 100584



JOHN DEERE 540D SKIDDER AND 548D GRAPPLE SKIDDER

CHECK LIST FOR PLANNED INSPECTION PROGRAM II (PIP II) — Field inspections contracted with the owner.

NOTE: Illustrated planned inspection program checks can be found in SP600.

	Inspection 1	Inspection 2	Inspection 3	Inspection 4
Machine Hours	_____	_____	_____	_____
Performed by	_____	_____	_____	_____
Mechanic Signature	_____	_____	_____	_____
Date	_____	_____	_____	_____
Owner's Name	_____	_____	_____	_____
Address	_____	_____	_____	_____
Signature	_____	_____	_____	_____
Dealership	_____	_____	_____	_____

NOTE: Do not remove these pages. Make photocopies for extra copies.

Item	OK	Comments
1. Test engine speed	<input type="checkbox"/>	_____
Slow idle		_____
Fast idle		_____
2. Test filter inlet pressure setting	<input type="checkbox"/>	_____
Gauge pressure		_____

Insert for OM-T77568 (H4)

Inspection Procedures

Item	OK	Comments
3. Test charge pressure	<input type="checkbox"/>	_____
Gauge pressure		_____
4. Test standby pressure setting	<input type="checkbox"/>	_____
Gauge pressure		_____
5. Test pressure control (priority) valve setting	<input type="checkbox"/>	_____
Gauge pressure		_____
6. Test differential lock valve setting	<input type="checkbox"/>	_____
Gauge pressure		_____
7. Test winch valve operation	<input type="checkbox"/>	_____
Gauge pressure		_____
8. Test clutch valve setting	<input type="checkbox"/>	_____
Gauge pressure		_____
9. Test differential lock accumulator setting	<input type="checkbox"/>	_____
Gauge pressure		_____
10. Test surge relief valve setting	<input type="checkbox"/>	_____
Gauge pressure		_____
11. Test cooler relief setting	<input type="checkbox"/>	_____
Gauge pressure		_____
12. Test system neutral leakage	<input type="checkbox"/>	_____
Increase in rpm		_____
13. Test circuit leakage	<input type="checkbox"/>	_____
Blade raise	<input type="checkbox"/>	_____
Grapple raise	<input type="checkbox"/>	_____
Grapple close	<input type="checkbox"/>	_____
Blade lower	<input type="checkbox"/>	_____
Grapple open	<input type="checkbox"/>	_____
Brake circuit	<input type="checkbox"/>	_____
Differential lock circuit	<input type="checkbox"/>	_____
Park brake circuit	<input type="checkbox"/>	_____

Insert for OM-T77568 (H4)

T82;SKPD CP 160588

Inspection Procedures

Item	OK	Comments
14. Test steering circuit leakage	<input type="checkbox"/>	_____
R.H. position rpm		_____
L.H. position rpm		_____
15. Test hydraulic pump output	<input type="checkbox"/>	_____
Cycle No. 1		_____
Cycle No. 2		_____
Cycle No. 3		_____
Cycle No. 4		_____
Cycle No. 5		_____
16. Measure drift	<input type="checkbox"/>	_____
Blade drift rate		_____
Grapple drift rate		_____
17. Brake system operation	<input type="checkbox"/>	_____
18. Park brake operation	<input type="checkbox"/>	_____
19. Test secondary steering circuit accumulator	<input type="checkbox"/>	_____
20. Test 8 inch winch drum rolling drag torque	<input type="checkbox"/>	_____
Rotating force		_____

Litho in U.S.A.

T82:SKPD CQ 160584

Section 01 WHEELS

CONTENTS

Page

GROUP 0110—Powered Wheels and Fastenings

Service Equipment And Tools	0110-1
Specifications	0110-1
Wheel	
Remove	0110-1
Install	0110-3
Tire	
Remove	0110-2
Install	0110-2

T47;0100 04 200488



SERVICE EQUIPMENT AND TOOLS

NOTE: Order tools from your SERVICE-GARD™ Catalog. Some tools may be available from a local supplier.

Name	Use
20-Ton Service Jack	To raise unit to install floor stand.
20-Ton Floor Stand	To support unit while removing and installing wheels.
Heavy Duty Wheel Lift	To remove and install wheels

T47:0110 54 200488

SPECIFICATIONS

ITEM	MEASUREMENT	SPECIFICATION
Wheel-to-axle cap screws	Torque	407 N-m (300 lb-ft)
Wheel assembly without fluid	Approximate weight	520 kg (1140 lb)

NOTE: Add 4.54 kg (10 lb) for every 1.59 kg (3-1/2 lb) calcium chloride per 3.785 L (1 gal) water added to tire.

T47:0110 33 090388

REMOVE WHEEL

⚠ CAUTION: Turn steering wheel to right and left until hydraulic pressure is released. Install lock bar between engine and equipment frame. Tire may be filled with fluid.

1. Loosen wheel cap screws before lifting unit off ground.
2. Raise axle housing using a 20-ton capacity service jack.
3. Put a 20-ton floor stand under axle housing.

⚠ CAUTION: The approximate weight of wheel assembly without fluid is 520 kg (1140 lb).

NOTE: Add 4.54 kg (10 lb) for every 1.59 kg (3-1/2 lb) calcium chloride per 3.785 L (1 gal) water added to tire.

4. Put wheel lift (B) under wheel. Fasten safety chain around upper portion of tire.
5. Remove three evenly spaced cap screws and install special studs (A). Remove remaining cap screws and pull wheel assembly away from unit.

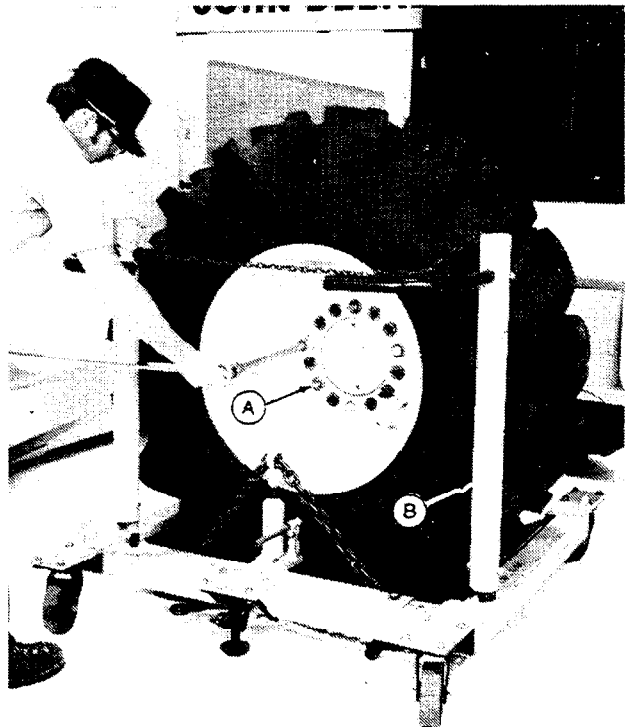

1AG:T95269 T47:0110 35 220388

REMOVE TIRE

NOTE: The tire can be removed without removing the wheel from machine. (See the John Deere Off-The-Road Tire Maintenance Manual to remove the tire from the wheel.)

CAUTION: Failure to follow proper procedures when demounting a tire from a wheel or rim can produce an explosion which may result in serious injury. **DO NOT** attempt to demount a tire unless you have the proper equipment and experience to perform the job safely. Have it done by a qualified tire repair service.

1. Rotate tire until the valve stem (A) is in the 12 o'clock position. If tire contains fluid, care must be taken when deflating.
2. Remove cover, valve cap, and depress valve stem (A) to completely deflate the tire. If unit has fluid, remove valve stem to remove fluid. If tire is flat, check valve stem (A) and make sure its not plugged.
3. Remove tire and inspect all parts for wear or damage; replace as necessary.

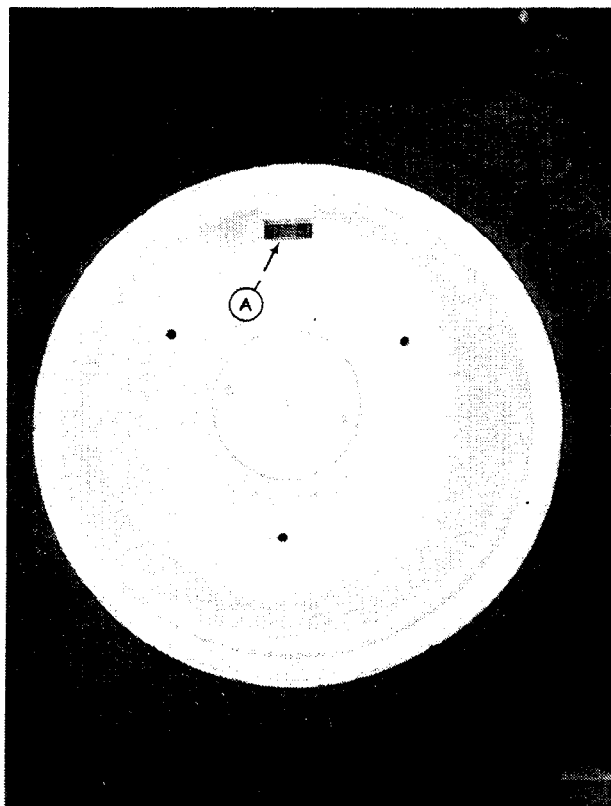

1AG;T5798AA T47;0110 47 310184

INSTALL TIRE

CAUTION: Failure to follow proper procedures when mounting a tire on a wheel or rim can produce an explosion which may result in serious bodily injury. **DO NOT** attempt to mount a tire unless you have the proper equipment and experience to perform the job safely. Have it done by a qualified tire repair service.

NOTE: See John Deere Off-The-Road-Tire Maintenance Manual to mount tire on wheel.

1. Make sure all parts are clean and free of paint, rust, oil, grease, dirt or other foreign material before assembly.
2. Install valve stem in rim base.

T47;0110 48 310184

3. Put soap lubricant on bead (A) of tire and mount tire on rim.

CAUTION: Serious bodily injury can occur from explosion when inflating tires if safe procedures are not followed.

4. Clear area of personnel.

5. Connect pressure regulating valve to valve stem and stand to one side of tire. DO NOT stand in front of tire when inflating.

6. Inflate tire until side flange of tire slides out against the rim. Adjust tire pressure.

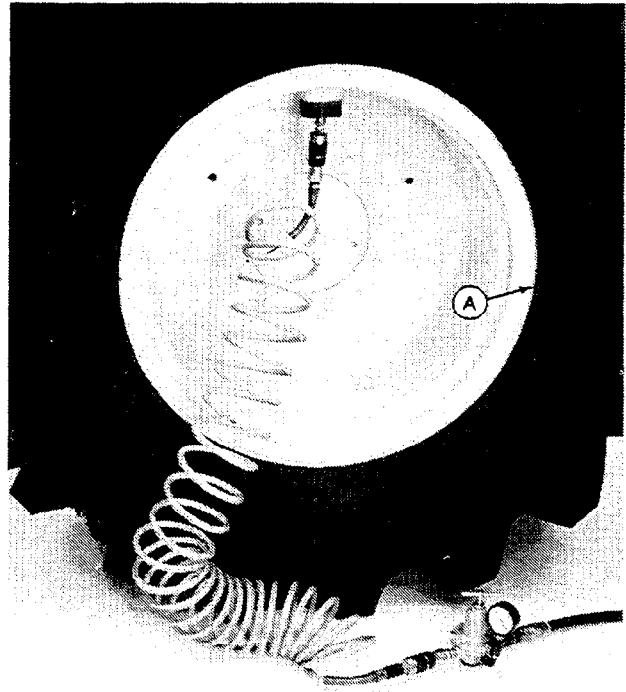

TIRE OPERATING PRESSURE

Tire Size	Type	Ply Rating	Pressure
18.4—26	LS-2	10	170 kPa (25 psi)
18.4—34	LS-2	10	170 kPa (25 psi)
23.1—26	LS-2	10	140 kPa (20 psi)
28 L—26	LS-3	10	140 kPa (20 psi)
23.1—26	LS-2	16	140 kPa (20 psi)
18.4—34	LS-2	16	140 kPa (20 psi)
68/34—26	LS-2	16	170 kPa (25 psi)

7. Put grease on cover threads. Install cap and cover.

1AG:T5798AB T47:0110 49 020384

INSTALL WHEEL

1. Cap screws, washers, and tapped holes must be clean and free of foreign material.

IMPORTANT: Start cap screws by hand to prevent thread damage.

2. Install wheel using wheel lift (B). Guide wheel over three special studs (A). Install three cap screws and washers. Remove studs; install remaining cap screws and washers. Tighten cap screws.

3. Remove shop stands and lower equipment to ground.

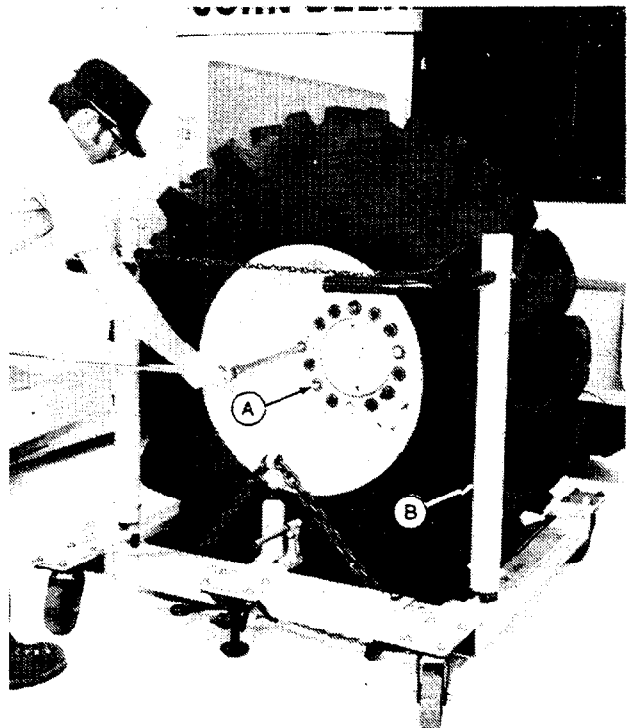

1AG:T95269 T47:0110 50 090388

Powered Wheels and Fastenings

4. Tighten cap screws to 407 N-m (300 lb-ft).

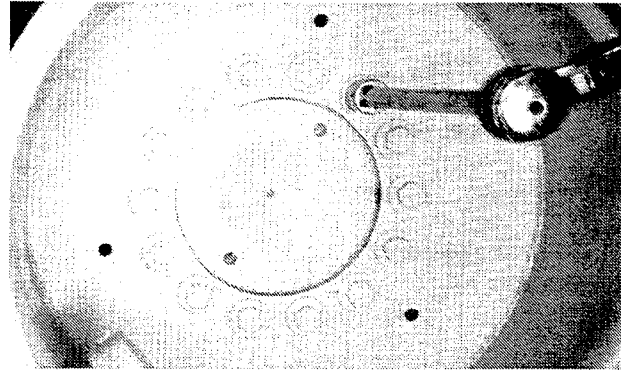

1AG;T95273 T47;0110 41 090388

Section 02

AXLES AND SUSPENSION SYSTEM

CONTENTS

	Page		Page
GROUP 0200—Removal and Installation		GROUP 0210—Differential or Bevel Drive—Continued	
Service Equipment and Tools	0200-1	Differential Housing	
Other Materials	0200-1	Remove	0210-9
Specifications	0200-2	Disassemble	0210-11
Front Axle		Assemble	0210-16
Remove	0200-3	Install	0210-21
Install	0200-4	Adjust Preload	0210-22
Front Differential and Axle Assembly		Assemble Input Quill and Drive Shaft ..	0210-24
Remove	0200-5	Adjust Cone Point	0210-25
Install and Adjust	0200-7	Adjust Drive Shaft	0210-27
Rear Differential and Axle Assembly		Front Differential	
Remove	0200-11	Assemble And Install Oscillating	
Install	0200-13	Support	0210-30
Oscillating Support		Rear Differential	
Remove and Disassemble	0200-14	Install Park Brake	0210-34
Assemble and Install	0200-17	Adjust Differential Backlash	0210-40
GROUP 0210—Differential or Bevel Drive		Check Bearing Pattern	0210-41
Service Equipment and Tools	0210-1	Continue Assembly of Differential	
Other Materials	0210-1	Housing	0210-41
Specifications	0210-2	Test Differential Lock Assembly	
Rear Differential		with Oil	0210-44
Remove Park Brake	0210-3	Install Brake Disk and Backing Plate	0210-44
Front Differential		Differential Case Air Leakage Test	0210-45
Remove and Disassemble Oscillating		Air Check Valve Test	0210-45
Support	0210-6	GROUP 0225—Input Drive Shafts	
Input Quill and Drive Shaft		And U-Joints	
Remove and Disassemble	0210-6	Service Equipment and Tools	0225-1
		Other Materials	0225-1
		Specifications	0225-1
		Front Differential Drive Line	
		Remove	0225-2
		Disassemble	0225-3
		Assemble	0225-3
		Install	0225-4
		Rear Differential Drive Line	
		Remove	0225-5
		Disassemble	0225-6
		Assemble	0225-7
		Install	0225-8

T47;0200 132 270588

CONTENTS

	Page
GROUP 0250—Axle Shaft, Bearings and Reduction Gears	
Service Equipment and Tools	0250-1
Other Materials	0250-1
Specifications	0250-2
Planet Pinion Carrier	
Remove	0250-2
Disassemble (540D)	0250-3
Disassemble (548D)	0250-3
Inspect	0250-3
Assemble (540D)	0250-4
Assemble (548D)	0250-5
Axle Housing	
Remove Axle Shaft	0250-6
Disassemble	0250-8
Replace Final Drive Ring Gear	0250-9
Assemble	0250-11
Grease Outer Axle Bearing	
Serial No. (-XXXXXX)	0250-14
Adjust	0250-15
GROUP 0260—Hydraulic System	
Service Equipment and Tools	0260-1
Specifications	0260-1
Differential Lock Valve	
Remove and Install	0260-2
Disassemble and Assemble	0260-2
Differential Lock Accumulator	
Remove and Install	0260-4

Group 0200 Removal and Installation

SERVICE EQUIPMENT AND TOOLS

NOTE: Order tools from your SERVICE-GARD™ Catalog. Some tools may be available from a local supplier.

Name	Use
JD292 Torque Converter Box Wrench	Used with 406 (16 in.) torque wrench to install front differential drive line-to-front differential yoke special cap screws.
20-Ton Floor Stand	To support unit when removing and installing front and rear axles and front and rear differential assemblies.
Low-Lift Transmission Jack	To remove and install front and rear differential and axle assemblies.
Mounting Arm	Used with low lift transmission jack.
Bushing, Bearing and Seal Driver Set	To remove and install bushings and seals.

T47;0200 87 130588

OTHER MATERIALS

Number	Name	Use
T43511	John Deere Clean and Cure Primer	Clean axle housing and differential housing mating surfaces.
T43514	John Deere Plastic Gasket	Seal axle housing and differential housing mating surfaces.
PT569	John Deere NEVER-SEEZ® Lubricant	Lubricate mating parts of front differential-to-engine frame parts.
TY9371	John Deere Thread Lock and Sealer (high strength)	Apply to rear differential drive line-to-parking brake special cap screw threads.

NEVER-SEEZ is a trademark of the Emhart Chemical Group.

T47;0200 74 080488

Removal and Installation

FRONT AXLE SPECIFICATIONS

Item	Measurement	Specification
IMPORTANT: Any cap screw can be tightened first, but an alternating sequence from one side to the other must be followed.		
Axle-to-differential case cap screws	Torque	244 N·m (180 lb-ft)
Axle	Approximate weight	241 kg (530 lb)

T47;0200 131 310588

FRONT DIFFERENTIAL SPECIFICATIONS

Item	Measurement	Specification
Front differential and axle assembly	Approximate weight	794 kg (1750 lb)
Rear oscillating support cap screws	Torque	929 N·m (685 lb-ft)
Front differential-to frame	End play	0.03—0.56 mm (0.001—0.022 in.)
Axle flange (without tires or rims)	Maximum force to move front differential freely	667 N (150 lb)
Front differential drive line special cap screws	Torque (with 406 mm (16 in.) torque wrench and JD292 Torque Converter Box Wrench)	95 N·m (67 lb-ft)
Front differential drive line special cap screws	Torque (without JD292 Torque Converter Box Wrench)	129 N·m (95 lb-ft)
Input yoke-to-input shaft nut—tighten to same position as marked during disassembly	Torque	305—407 N·m (225—300 lb-ft)
Thrust plate retaining pin	Height of pin above case	5 mm (0.020 in.)

T47;0200 88 260588

REAR DIFFERENTIAL SPECIFICATIONS

Item	Measurement	Specification
Rear differential and axle assembly	Approximate weight	794 kg (1750 lb)
Rear axle-to-frame nuts	Torque	576 N·m (425 lb-ft)
Rear differential drive line-to-park brake hub special cap screws	Torque	129 N·m (95 lb-ft)
Equipment frame bottom guard cap screws .	Torque	407 N·m (300 lb-ft)
Axle housing stop cap screws (grapple units only)	Torque	407 N·m (300 lb-ft)
Axle housing stop nuts (grapple units only)	Torque	203 N·m (150 lb-ft)

T47:0200 130 260588

REMOVE FRONT AXLE

1. Install frame locking bar.
2. Remove differential drain plug. Drain oil and install plug. Oil capacity is approximately 17 L (4.5 gal).
3. Remove wheel from axle to be serviced. (See Remove Wheel, Group 0110.)
4. Install shop stand under engine frame on same side as axle to be serviced.
5. Carefully lower unit onto stand.
6. Remove four bottom axle to differential cap screws, if service jack is used.



CAUTION: Axle housing weighs approximately 241 kg (530 lb).

7. Connect axle housing to suitable service jack with two cap screws as shown, or attach lifting straps to axle housing.
8. Remove remaining cap screws to remove axle.

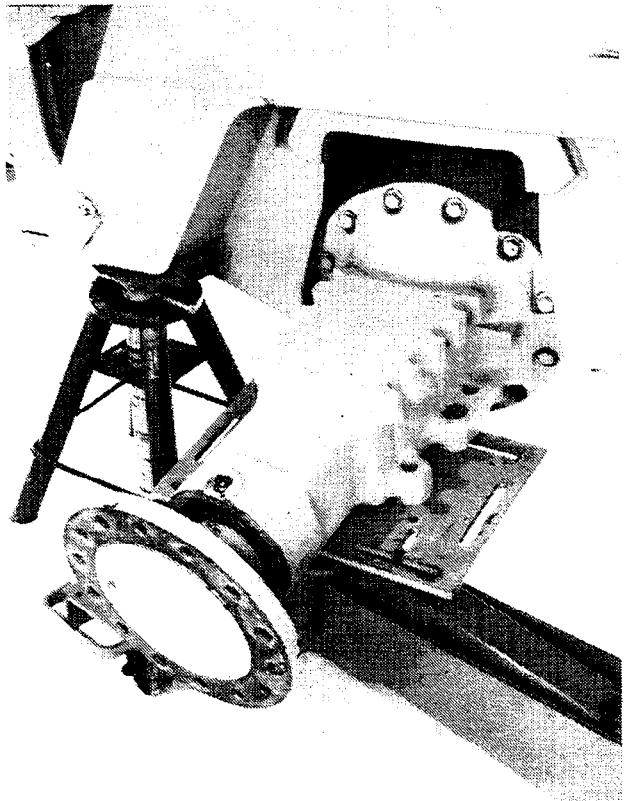

5AG/T5872AJ T47:0200 89 110584

Removal and Installation

9. Remove and inspect parts (A—D). (See Group 0250 for disassembly of axle. See Group 1011 for repair of service brakes.)

10. Clean mating surfaces (E) using clean and cure primer.

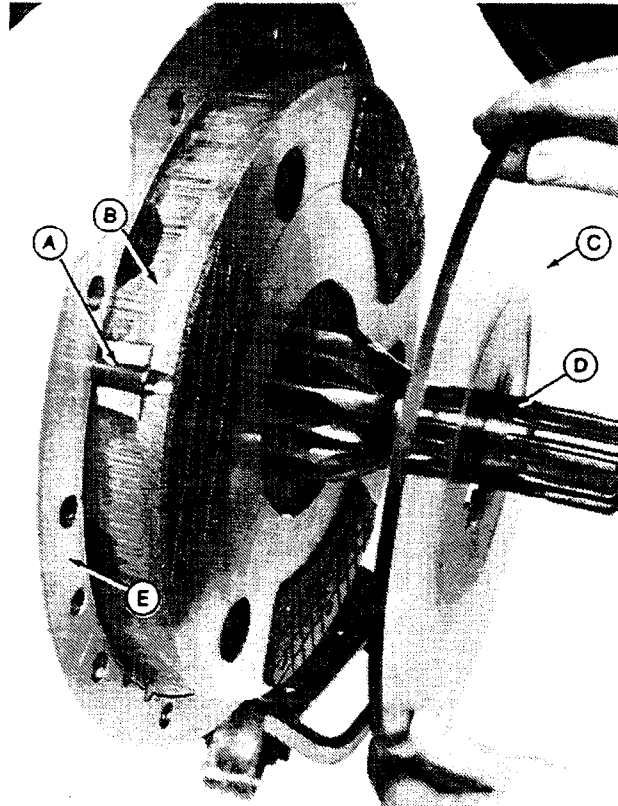

A—Dowel Pin (3 used)
B—Brake Backing Plate

C—Brake Disk
D—Sun Drive Gear
E—Axle to Differential
Mating Surface

5AG:T5872AK T47;0200 90 250588

INSTALL FRONT AXLE

1. Install parts (A—D).

2. Apply plastic gasket evenly to the differential case and axle housing mating surfaces (E).

3. Immediately install axle housing while turning sun drive gear (D) slowly to align planet pinions with sun pinions.

IMPORTANT: Any cap screw can be tightened first, but an alternating sequence from one side to the other must be followed.

4. Install and alternately tighten cap screws to 244 N·m (180 lb-ft).

5. Fill differential with the recommended oil (Section I, Group IV). Oil capacity is approximately 17 L (4.5 gal).

6. Install wheel. (See Install Wheel, Group 0110.)

A—Dowel Pin (3 used)
B—Brake Backing Plate

C—Brake Disk
D—Sun Drive Gear
E—Axle to Differential
Mating Surface

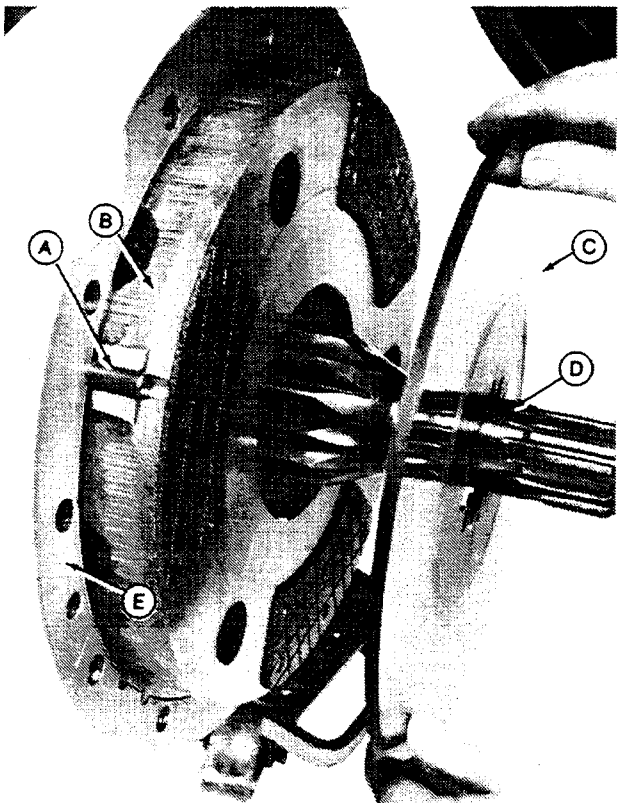

5AG:T5872AK T47;0200 91 250588

REMOVE FRONT DIFFERENTIAL AND AXLE ASSEMBLY

NOTE: Remove differential and axles as one assembly.

1. Install frame locking bar.

NOTE: Bottom of main frame must be approximately 457 mm (18 in.) plus the lowered height of service jack used.

2. Raise unit. Install two floor stands under frame.
3. Disconnect battery ground cable.
4. Operate control valves to release pressure in the hydraulic system. Pump the brake pedal to discharge brake accumulator.
5. Remove wheels. (See procedure in Group 0110.)
6. Remove drain plug (A). Drain oil and install plug. Hydraulic oil capacity is approximately 17 L (4.5 gal).



CAUTION: The approximate weights of engine frame bottom guards are:

Front Guard 30 kg (67 lb)
Rear Guard 23 kg (50 lb)
Weight may increase due to the buildup mud and debris.

7. Remove front and rear engine frame bottom guards.

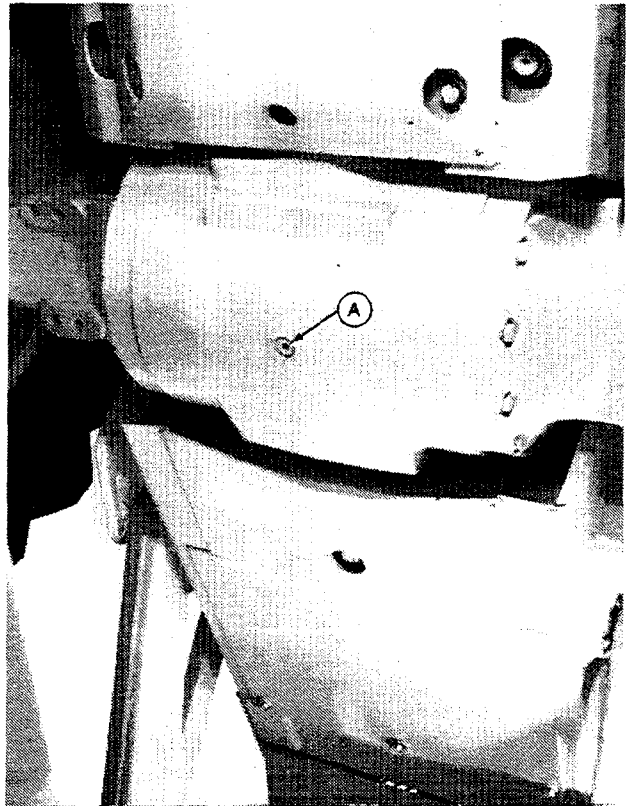

5AG,T5874AD T47;0200 92 250588

8. Remove four special cap screws (A) to disconnect front differential drive line.

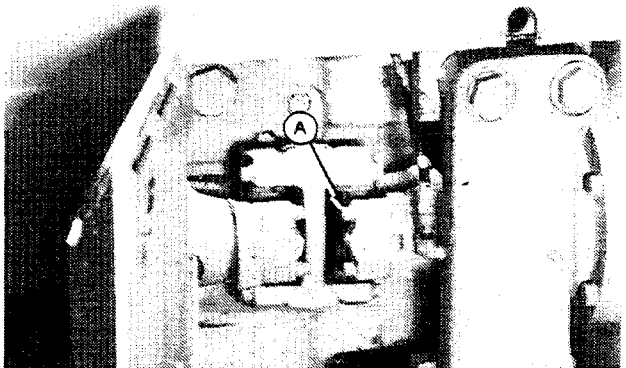

5AG,T5876AG T47;0200 93 110684

Removal and Installation

9. Lower and block right axle to provide clearance under the frame.

10. Disconnect lines (A, B, and C). Close all openings with caps and plugs.

A—Line—From Differential Lock Valve

B—Line—From Intake Manifold (Turbocharger)

C—Line—From Brake Valve

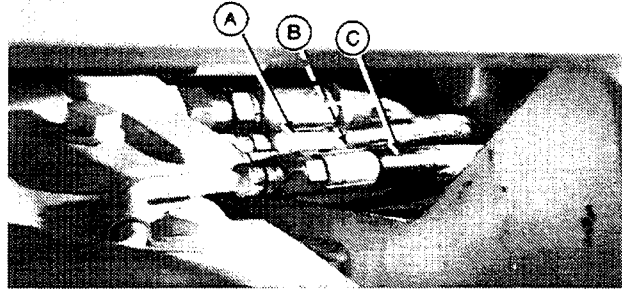

5AG:T5872AM T47:0200 94 110684

11. Lower and block left axle.

12. Disconnect line (A).

A—Line—Differential Lock Return to Reduction Gear Housing

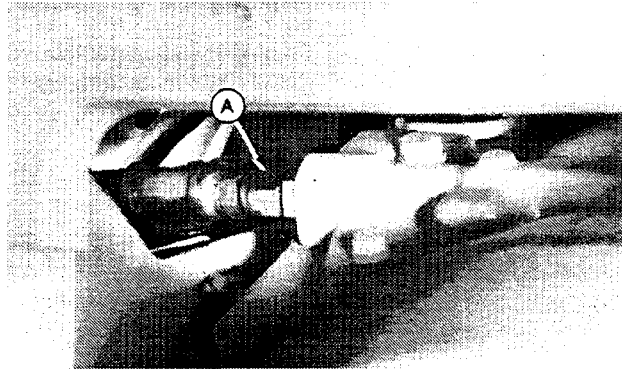

5AG:T5872AN T47:0200 95 110684



CAUTION: Differential with axles weighs approximately 794 kg (1750 lb).

13. Install a suitable service jack under differential section.

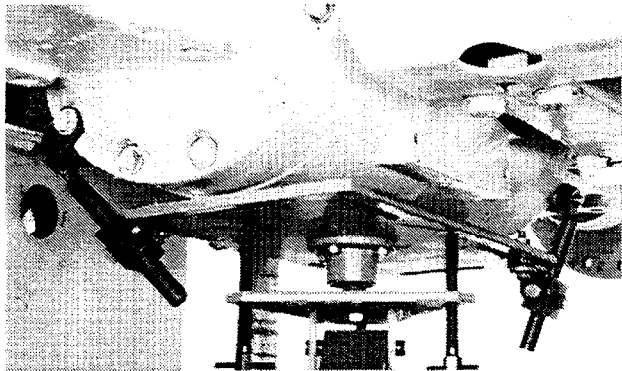

5AG:T5872A0 T47:0200 96 110684

14. Disconnect line (C).

15. Remove cap screw (A).

16. Install cap screw (A) or a slide hammer in threaded hole in pin (B) and remove pin.

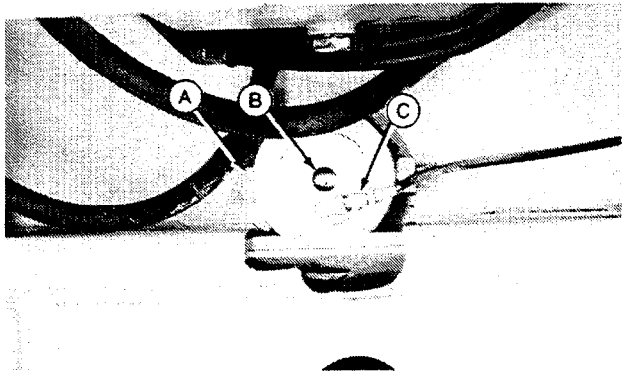

5AG:T5872AP T47:0200 97 250588

Removal and Installation

17. Disconnect grease line (B).
18. Remove rear oscillating support (A)-to-frame cap screws.
19. Carefully lower differential axle assembly.

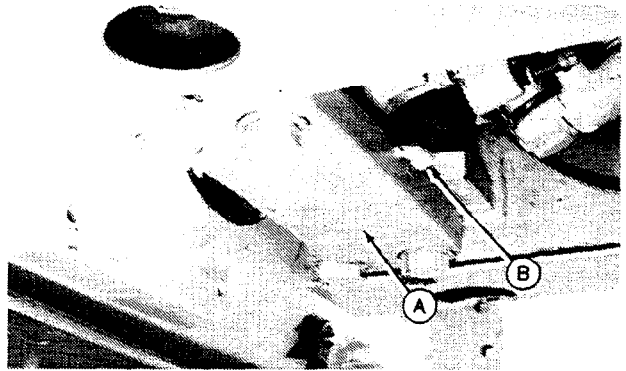

5AG:T5872AQ T47;0200 98 140588

20. Inspect dowels (A) for looseness, wear or damage. Replace if necessary.

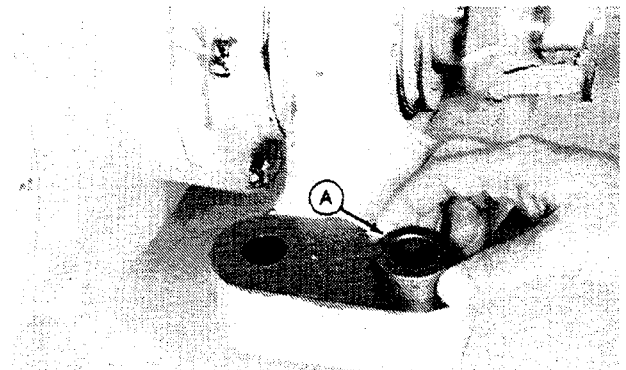

5AG:T95399 T47;0200 125 120684

21. Remove grease seal.
22. Inspect bushing (A). Remove only if replacement is necessary.
23. Inspect pin (B) for looseness or damage.

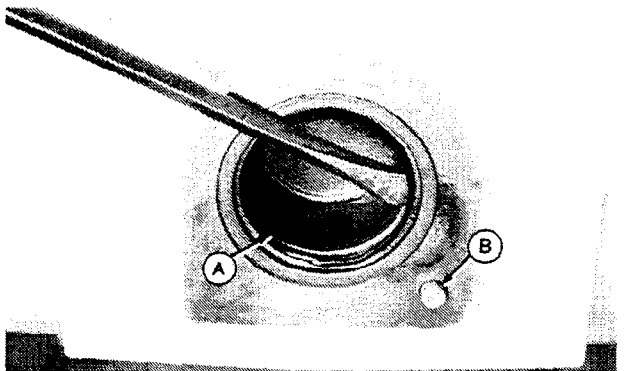

5AG:T5872AR T47;0200 99 120684

INSTALL AND ADJUST FRONT DIFFERENTIAL AND AXLE ASSEMBLY

1. Install new pin (B), if removed or case is being replaced. Install pin until 5 mm (0.20 in.) of pin protrudes from mounting surface.
2. Install new bushing (A) if removed, using 76 mm and 85 mm disks. Install bushing even with outside edge of inner bore.

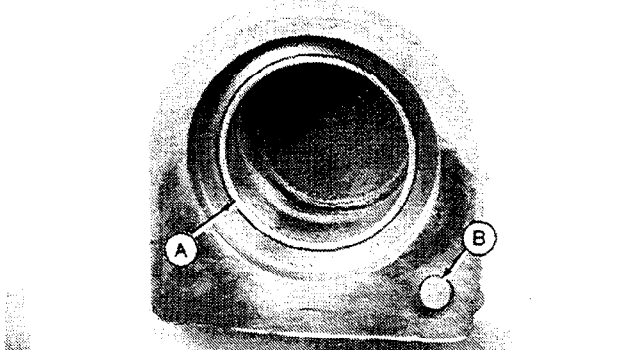

5AG:T5872AS T47;0200 100 140588

Removal and Installation

3. Put grease seal in clean hydraulic oil for at least one hour before installing.

4. Install grease seal with sealing lips toward outside. Use 75 mm and 110 mm disks to install seal even with outside edge of bore.

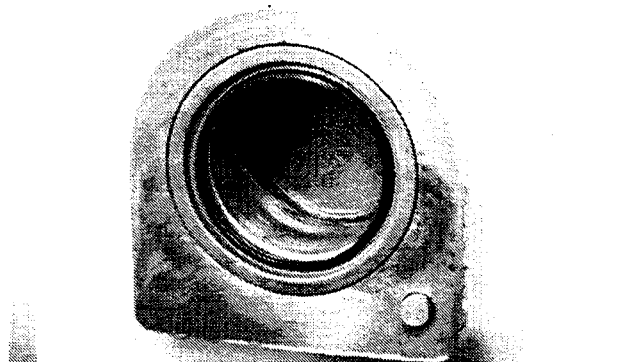

5AG;T5872AT T47;0200 101 260588

5. Carefully raise differential into position. Make sure front pivot pin hole in differential case is aligned with pivot pin hole in engine frame.

6. Install and tighten rear oscillating support cap screws to approximately 136 N·m (100 lb-ft).

7. Apply John Deere NEVER-SEEZ lubricant or equivalent to pin, pin bore in frame, thrust plates, and thrust plate mating surface on differential case.

NOTE: Differential shown removed for clarity of photograph.

8. Install thrust plates (A and B) and washer (C) as shown.

9. Install pin; care must be taken not to damage grease seal.

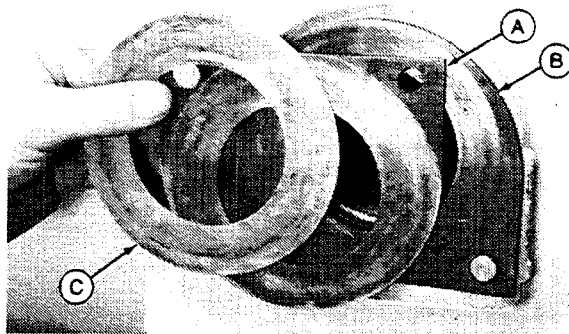

5AG;T5872AV T47;0200 102 210886

Removal and Installation

10. Move differential rearward as far as possible using a pry bar.

11. Measure differential end play using a feeler gauge. Adjust end play by adding or removing shims between frame and first thrust plate.

END PLAY SPECIFICATIONS

End play 0.03–0.56 mm
(0.001–0.022 in.)

12. A force of 667 N (150 lb) maximum, measured at the axle flange without tires or rims, must move the front differential assembly freely. If a force of more than 667 N (150 lb) is required do end play adjustment again.

13. Tighten oscillating support cap screws to 929 N·m (685 lb-ft).

14. Install and tighten front pivot pin cap screw.

15. Install engine frame front bottom guard. Tighten cap screws to 230 N·m (170 lb-ft).

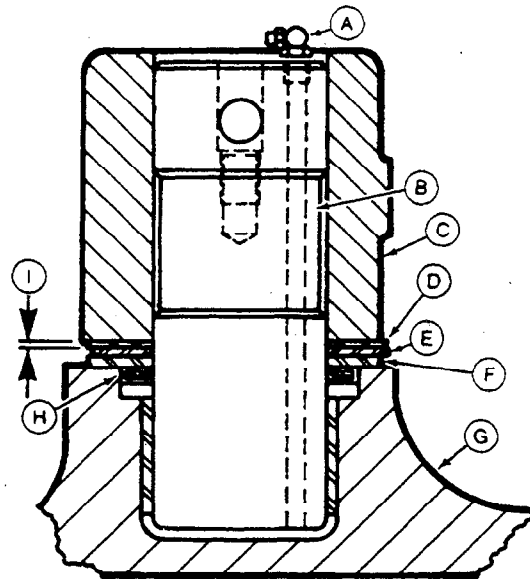

- | | |
|--|----------------------|
| A—Grease Fitting | E—Rear Thrust Plate |
| B—Pin | F—Front Thrust Plate |
| C—Oscillating Differential Front Support | G—Differential Case |
| D—Special Washer and Shims (as required) | H—Grease Seal |
| | I—End Play |
| | 0.03–0.56 mm |
| | (0.001–0.022 in.) |

SAG;T5872AW, T6780AI T47;0200 103 060688

16. Connect front differential drive line. Install and tighten four special cap screws to 95 N·m (70 lb-ft) using a 406 mm (16 in.) torque wrench and JD292 Torque Converter Box Wrench. If special tool JD292 is not used, tighten cap screws to 129 N·m (95 lb-ft).

17. Install engine frame rear bottom guard. Tighten cap screws to 230 N·m (170 lb-ft).

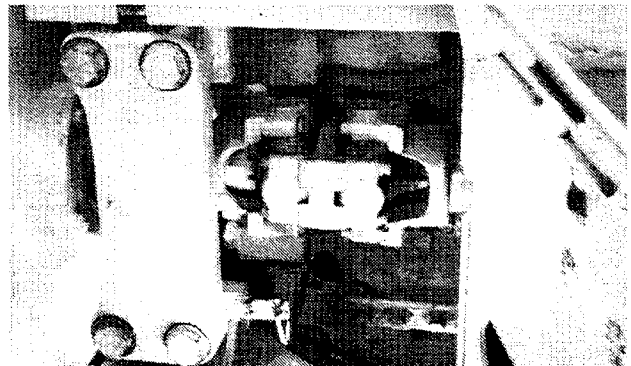

SAG;T5872AL T47;0200 104 140588

Removal and Installation

19. Connect line (A).

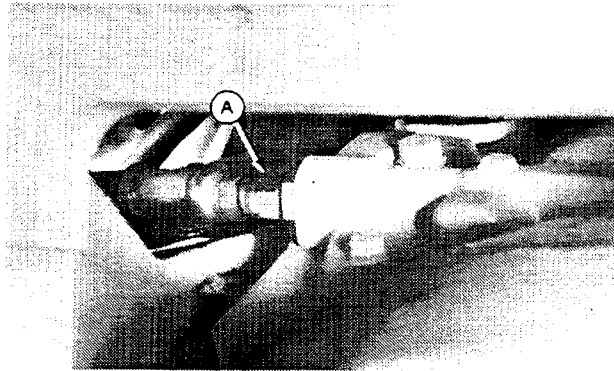

**A—Line—Differential Lock Return
to Reduction Gear Housing**

5AG,T5872AN T47:0200 105 120684

19. Connect lines (A, B, and C).

20. Fill differential with the recommended oil (See Section I, Group IV). Oil capacity is approximately 17 L (4.5 gal).

21. Install wheels. (See Group 0110.)

22. Connect battery ground cable.

**A—Line—From Differential
Lock Valve**

C—Line—From Brake Valve

**B—Line—From Intake
Manifold (Turbocharger)**

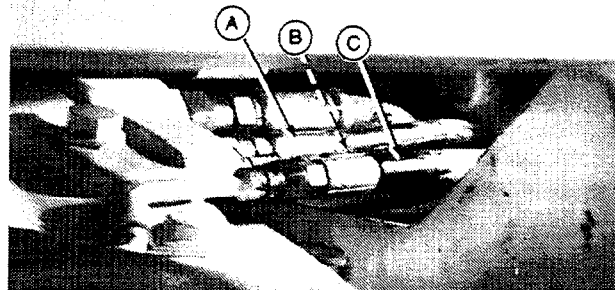

5AG,T5872AM T47:0200 106 140588

REMOVE REAR DIFFERENTIAL AND AXLE ASSEMBLY

NOTE: An alternate method of removal is to disconnect axle housings from frame after disconnecting drive shaft, lifting frame enough to roll assembly out.

1. Install frame lock bar.
2. Disconnect battery ground cable.
3. Operate control valves to release pressure in the hydraulic system. Pump the brake pedal to discharge brake accumulator.

Operate the park brake lever at least 50 times to release pressure in the park brake accumulator.

4. Remove drain plug. Drain oil and install plug. Hydraulic oil capacity is approximately 17 L (4.5 gal).

NOTE: The bottom of main frame must be approximately 457 mm (18 in.) above the floor, plus the lowered height of service jack used.

5. Raise unit. Install two floor stands.
6. Remove wheels. (See Group 0110).
7. Remove equipment frame bottom guard.

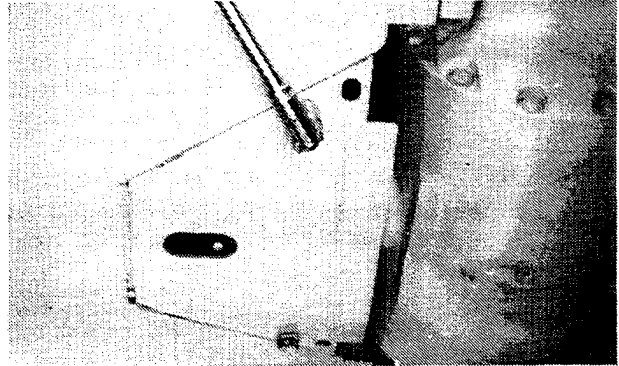

5AG;T95408 T47;0200 107 140588

Removal and Installation

⚠ CAUTION: Escaping fluid under pressure can penetrate the skin causing serious injury. Relieve pressure before disconnecting hydraulic or other lines. Tighten all connections before applying pressure. Keep hands and body away from pinholes and nozzles which eject fluids under high pressure. Use a piece of cardboard or paper to search for leaks. **DO NOT** use your hand.

If **ANY** fluid is injected into the skin, it must be surgically removed within a few hours by a doctor familiar with this type injury or gangrene may result.

NOTE: Fuel tank was removed for clarity of photograph.

8. Disconnect park brake hydraulic line (A). Close all openings with caps and plugs.
9. Remove four special cap screws (B) to disconnect rear differential drive line.

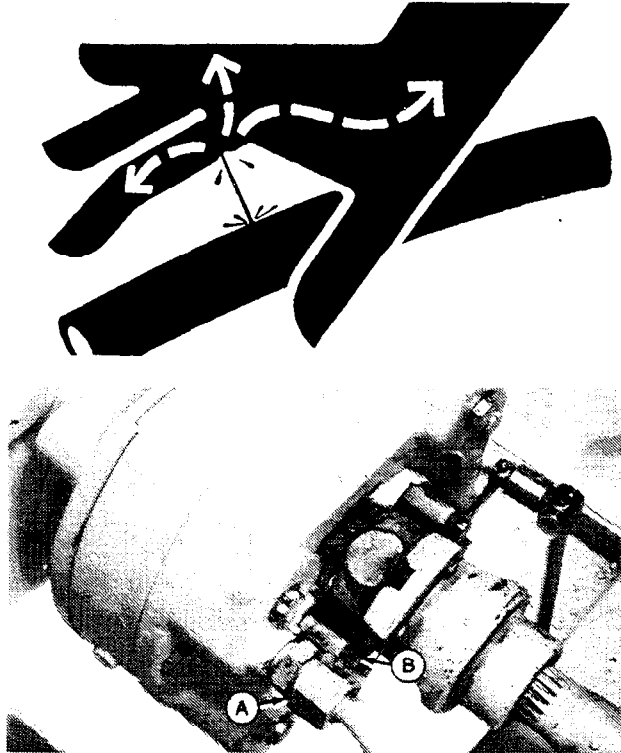

5AG:X9811, T5820AK1 T47:0200 108 120684

10. Disconnect lines (A, B, and C).

A—Line—From Intake Manifold (Turbocharger)	C—Line—Differential Lock Return to Reduction Gear Housing
B—Line—From Differential Lock Valve	

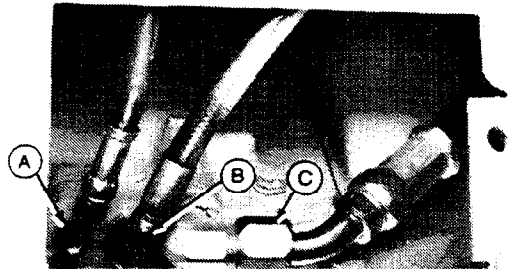

5AG:T5876AE T47:0200 110 120684

11. Grapple units only: Loosen either four front or four rear nuts (A) and move cap screws (B) away from axle housing.

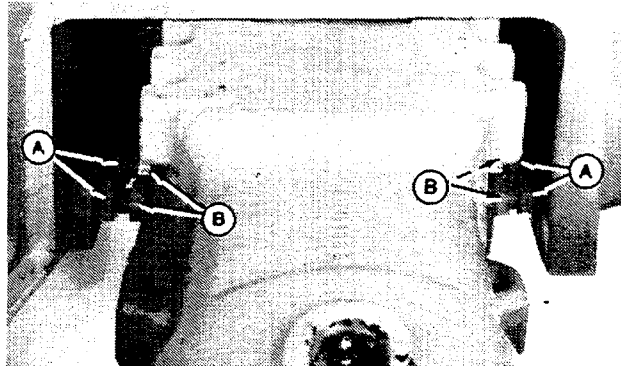

5AG:T5872AG T47:0200 109 120684

Removal and Installation

CAUTION: Differential with axles and parking brake weighs approximately 795 kg (1750 lb).

12. Install a suitable service jack under differential section.
13. Remove four cap screws and nuts from each side of axle and carefully remove differential.

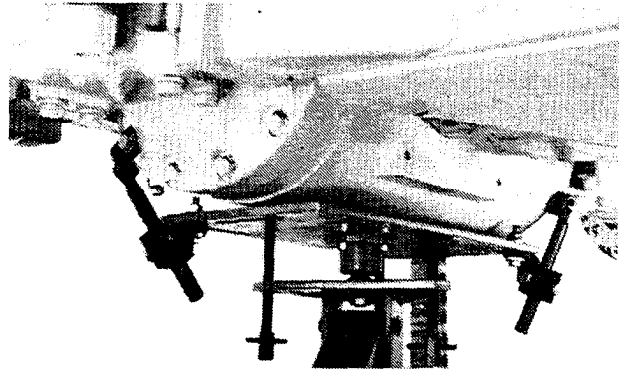

5AG;T5872AH T47;0200 111 120684

INSTALL REAR DIFFERENTIAL AND AXLE ASSEMBLY

1. Carefully install differential with axles.
2. Install cap screws (A) and nuts. Tighten nuts to 576 N·m (425 lb-ft).

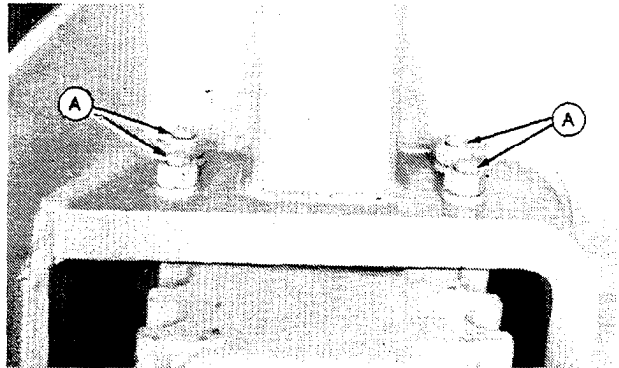

5AG;T5872AG1 T47;0200 126 250588

3. Grapple units only: Turn cap screws (B) evenly against axle housing. Tighten cap screws to 407 N·m (300 lb-ft).
4. Tighten nuts (A) to 203 N·m (150 lb-ft).

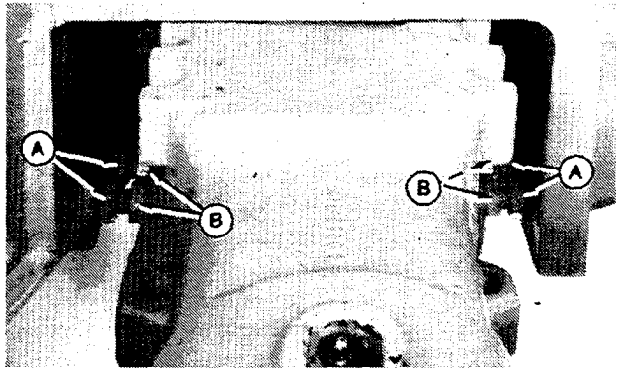

5AG;T5872AG T47;0200 128 120684

5. Connect lines (A, B, and C).

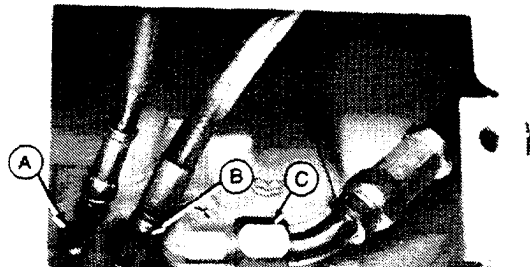

A—Line—From Intake Manifold (Turbocharger)
B—Line—From Differential Lock Valve

C—Line—Differential Lock Return to Reduction Gear Housing

5AG;T5876AE T47;0200 127 190684

Removal and Installation

6. Connect line (A).
7. Connect drive line. Apply high strength thread lock sealer to threads of cap screws. Install and tighten cap screws (B) to 129 N·m (95 lb-ft).
8. Install equipment frame bottom guard and cap screws. Tighten cap screws to 407 N·m (300 lb-ft).
9. Connect battery ground cable.
10. Fill differential with recommended oil (See Section I, Group IV). Oil capacity is approximately 17 L (4.5 gal).

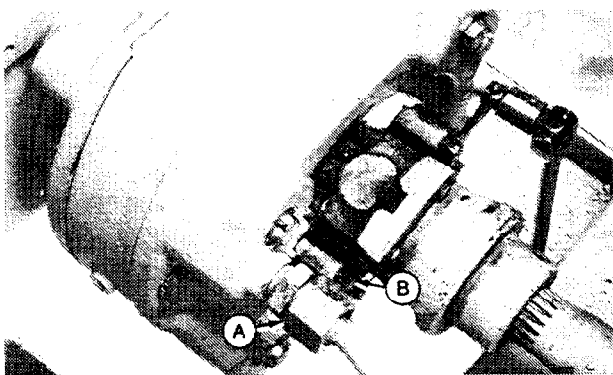

5AG/T5820AK1 T47;0200 129 250588

REMOVE AND DISASSEMBLE FRONT DIFFERENTIAL OSCILLATING SUPPORT

1. Install frame locking bar.
2. Put a DO NOT operate tag on steering wheel.
3. Remove drain plug (A). Drain oil and install plug. Hydraulic oil capacity is approximately 17 L (4.5 gal).



CAUTION: The approximate weight of engine frame bottom guards are:

Front Guard 30 kg (76 lb)
Rear Guard 23 kg (50 lb)

Weight may increase due to the buildup of mud and debris.

4. Remove front and rear engine frame bottom guards.

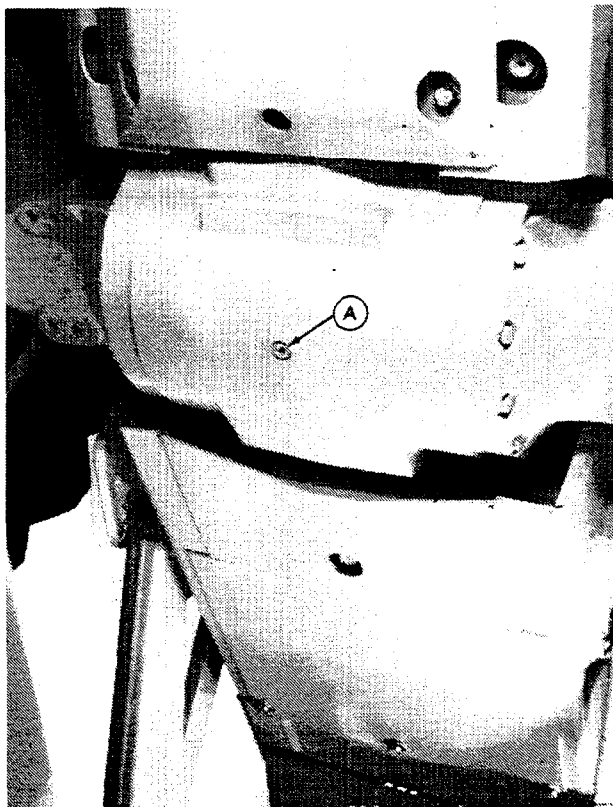

5AG/T5874AD T47;0200 112 250588

Removal and Installation

5. Disconnect line (B).
6. Remove drive shaft.
7. Make a mark so yoke-to-input shaft nut can be installed in exact spot on shaft. Remove cotter pin to loosen nut (A).
8. Raise unit just enough to allow oscillating support dowels to clear frame. Install two floor stands under frame and a service jack under differential.

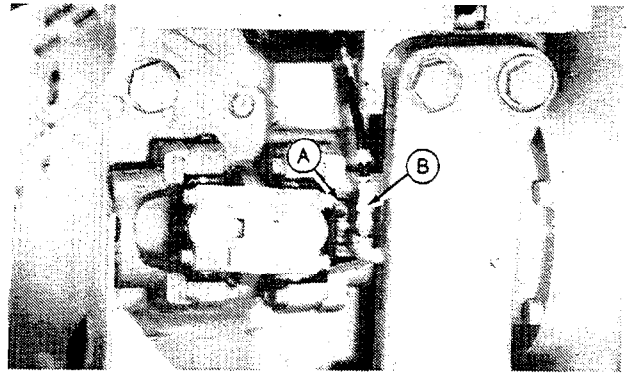

5AG;T5876AF T47;0200 113 140588

9. Operate control valves to release pressure in hydraulic system. Pump brake pedal to discharge brake accumulator.
10. Disconnect battery ground cable.
11. Disconnect line (C).
12. Remove cap screw (A).
13. Install cap screw (A) or a slide hammer in hole in pin (B) and remove pin.

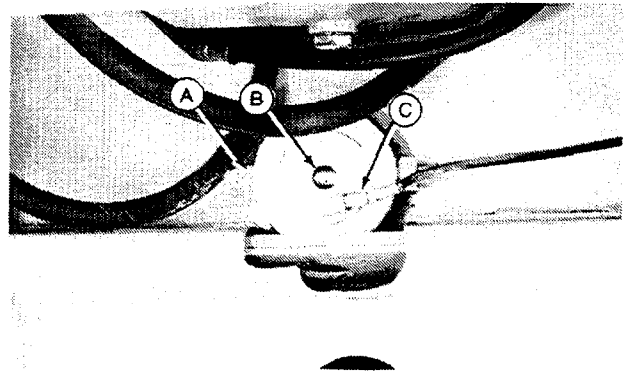

5AG;T5872AP T47;0200 114 250588

14. Remove nut (A), washer (B), O-ring (D), and yoke (C).
15. Remove four support to frame cap screws.

A—Nut
B—Washer

C—Yoke
D—O-Ring

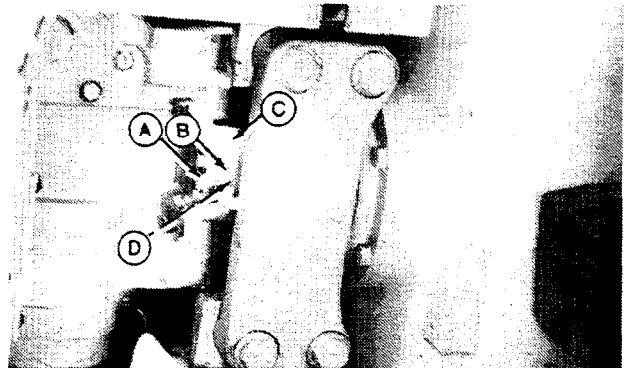

5AG;T5876AH T47;0200 115 120684

Removal and Installation

16. Lower differential just enough to allow clearance for support dowels (B).

17. Remove support and thrust washer (A).

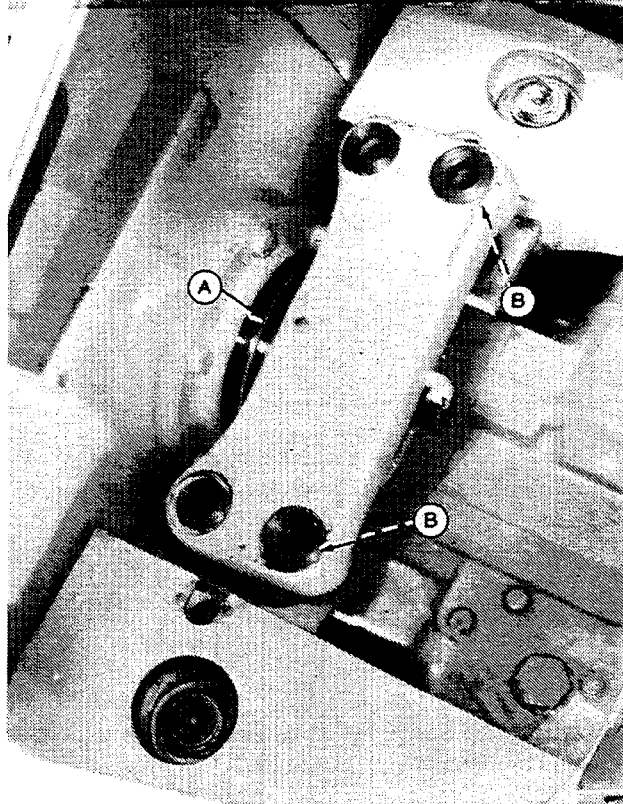

5AG;T5876A1 T47;0200 116 120684

18. Remove bushing using 135 mm disk or JDG92 Bearing Cup Installer.

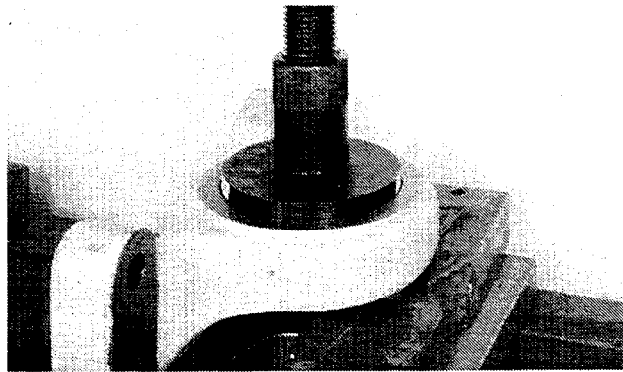

Early Units Shown

5AG;R38386 T47;0200 117 140588

19. Inspect dowels (A) for looseness or damage.

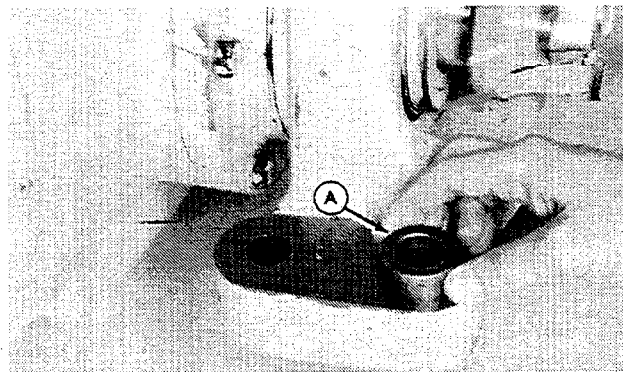

5AG;T95399 T47;0200 118 120684

Removal and Installation

ASSEMBLE AND INSTALL FRONT DIFFERENTIAL OSCILLATING SUPPORT

1. Install new dowels, if necessary.
2. For early units, install new bushing using 135 mm disk or JDG92 Bearing Cup Installer.

For later units, install bushing even with thrust washer contact surfaces. (See procedure in Group 0210 for installation of V-ring seals.)

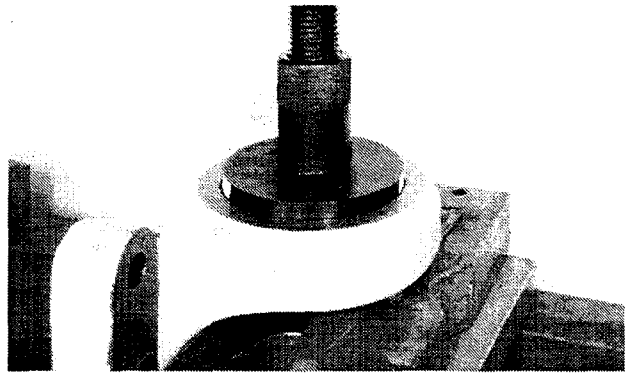

5AG;R38386 T47;0200 119 140588

3. Install thrust washer (A) and support with dowels (B).
4. Carefully raise differential into position. Make sure front pivot pin hole in differential case is aligned with pivot pin hole in engine frame.
5. Install and tighten four support to frame cap screws to approximately 136 N·m (100 lb-ft).
6. Apply John Deere NEVER-SEEZ lubricant or equivalent to pin and pin bore in frame.

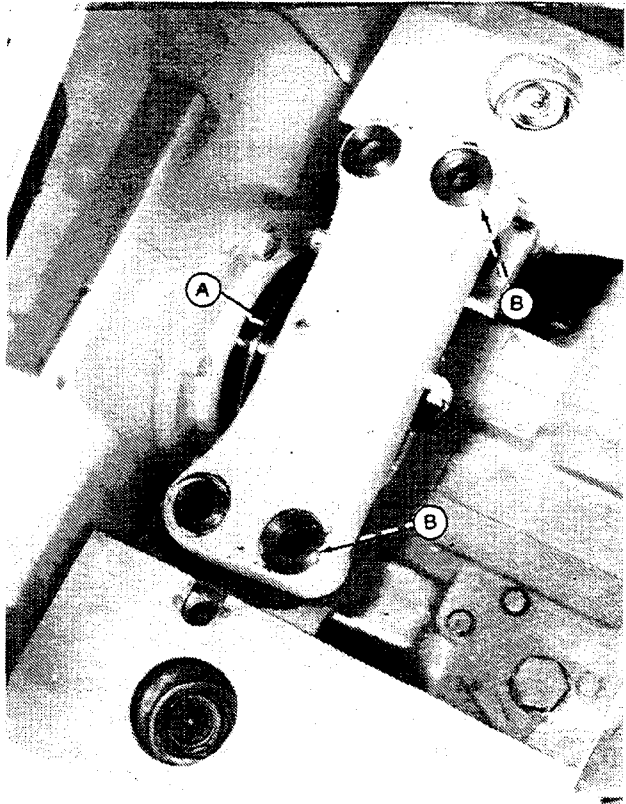

5AG;T5876AI T47;0200 120 140588

7. Apply John Deere NEVER-SEEZ lubricant or equivalent to thrust plates, if removed.
8. Check to be sure thrust plates (A and B) and washer (C) are installed correctly.

NOTE: Differential shown removed for clarity of photograph.

9. Install front pivot pin; care must be taken not to damage grease seal in differential case.

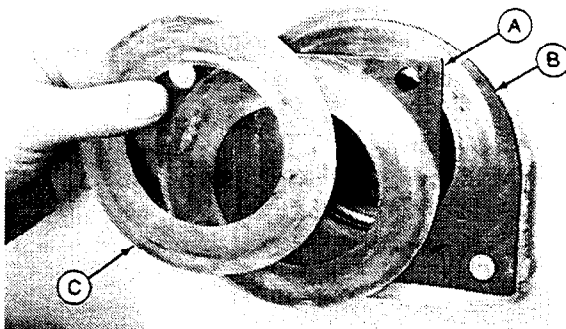

5AG;T5872AV T47;0200 121 140588

Removal and Installation

10. Move differential rearward as far as possible, using a pry bar.

11. Measure differential end play using a feeler gauge. Adjust end play by adding or removing shims between frame and first thrust plate.

END PLAY SPECIFICATIONS

End play 0.03—0.56 mm
(0.001—0.022 in.)

12. A force of 667 N (150 lb) maximum, measured at the axle flange without tires or rims must move the front differential assembly freely. If a force of more than 667 N (150 lb) is required, do end play adjustment again.

13. Tighten oscillating support cap screws to 929 N·m (685 lb-ft). Connect grease line.

14. Install and tighten front pivot pin cap screw.

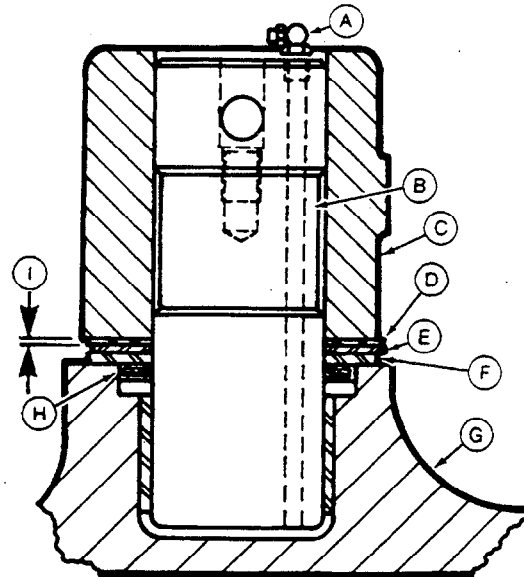

- | | |
|--|----------------------|
| A—Grease Fitting | E—Rear Thrust Plate |
| B—Pin | F—Front Thrust Plate |
| C—Oscillating Differential Front Support | G—Differential Case |
| D—Special Washer and Shims (as required) | H—Grease Seal |
| | I—End play |
| | 0.03—0.56 mm |
| | (0.001—0.022 in.) |

5AG:T5872AW, T6780AI T47:0200 122 260588

15. Install yoke (C), O-ring (D), washer (B), and nut (A). Tighten nut until it is the same position that it was before being removed. With nut in this position it must be tightened to 305—407 N·m (225—300 lb-ft).

16. Install cotter pin. DO NOT bend ends of pin over end of shaft; bend ends of cotter pin against flats of nut.

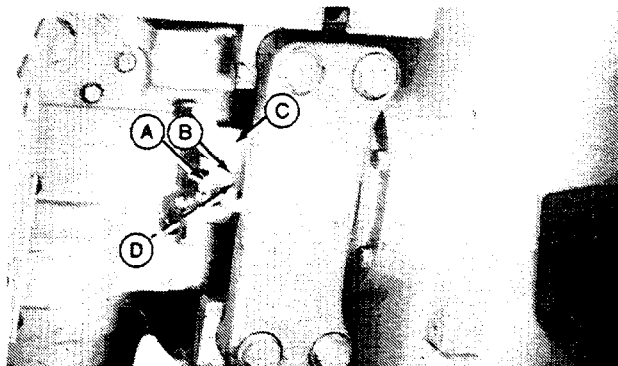

- | | |
|----------|----------|
| A—Nut | C—Yoke |
| B—Washer | D—O-Ring |

5AG:T5876AH T47:0200 123 140588

Removal and Installation

17. Install differential drive shaft. install and tighten special cap screws to 95 N·m (70 lb-ft) using a 406 mm (16 in.) torque wrench and JD292 Torque Converter Box Wrench. If special tool JD292 is not used, tighten cap screws to 129 N·m.

18. Install engine frame bottom guards. Tighten cap screws to 230 N·m (170 lb-ft).

19. Fill differential with recommended oil (See Section I, Group IV). Oil capacity is approximately 17 L (4.5 gal).

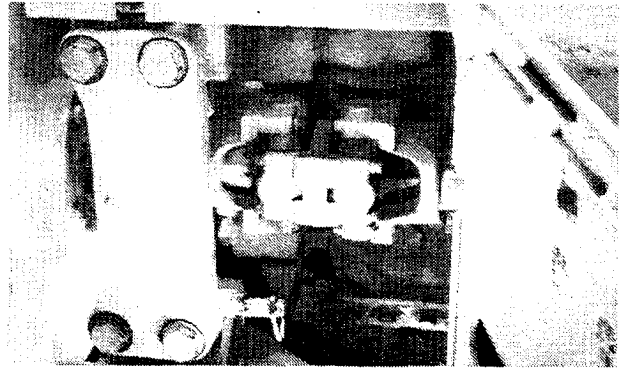

SAG:T5872AL T47:0200 124 260588

Removal and Installation

Group 0210 Differential or Bevel Drive

SERVICE EQUIPMENT AND TOOLS

NOTE: Order tools from your SERVICE-GARD™ Catalog. Some tools may be available from a local supplier.

Name	Use
*JT38000 Differential Lifting Tool	To remove and install differential assembly.
*JT38002 Yoke Holding Tool	To hold yoke while removing and installing slotted nut.
Puller	To remove bearing.
Knife Edge Puller	To remove bushing.
Spring Compression Tester	To check springs.
51 mm Disk	To remove and install bushings and bearing cups.
60 mm Disk	
93 mm Disk	
111 mm Disk	
120 mm Disk or JDG264 Wear Ring Installer	
136 mm Disk or JDG-92 Bearing Cup Installer	
JDG-185 Air Test Plug	To test for leakage of differential lock quill.

*Fabricated tools, dealer made. (See Section 99 for instructions to make tools.)

R50;50300 2176 130488

OTHER MATERIALS

Number	Name	Use
AT38226	Epoxy (3M No. 2158).....	To install ring gear cap screws.
TY6304.....	Flexible Sealant	To install differential case cover.
TY6305.....	Clean and Cure Primer	To prime surfaces for T43514 Plastic Gasket and TY6304 Flexible Sealant.
T43513	Thread Lock and Sealer	To install brake piston housing-to-spring housing screws.
	(High Strength)	
T43515	Retaining Compound	To install planet pinion shaft retaining pin set screws.
T43514	Plastic Gasket	To install differential drive shaft quill seal and plugs and park brake, oil gallery plugs.
TY9375.....	Pipe Sealant	To install pipe nipples (in differential cover) park brake oil drain, oil filler and oil level plugs.

R50;50300 2218 020588

Differential or Bevel Drive

SPECIFICATIONS

Item	Measurement	Specification
Differential:		
Carrier Bearings	Preload	0.05—0.10 mm (0.002—0.004 in.)
Carrier	Rolling Drag Torque	9—35 N (2.1—7.8 lb)
Drive Shaft	Rolling Drag Torque (W/O Seal)	0.2—1.1 N·m (2—10 lb-in.)
	Backlash	0.2—0.36 mm (0.008—0.014 in.)
Lock Return Spring	Free Length (approximate)	29.5 mm (1.61 in.)
	Test Length (at 200—245 N	18.8 mm
	(45—55 lb force	0.74 in.)
Housing		
Cover Cap Screws	Torque	68 N·m (50 lb-ft)
Differential Quill Cap Screws	Torque	108 N·m (80 lb-ft)
Drive Shaft		
Quill Cap Screws	Torque	50 N·m (37 lb-ft) plus 90 degrees (1/4 turn)
Lock Line and Fittings	Torque	14 N·m (10 lb-ft)
Cover Cap Screws	Torque	75 N·m (55 lb-ft)
Relief Valve (in cover)	Torque	8—16 N·m (6—12 lb-ft)
Ring Gear Cap Screws	Torque	150 N·m (110 lb-ft)
Park Brake:		
Spring Housing-to-Differential Case		
Cap Screws	Torque	
Plated Cap Screws		50 N·m (37 lb-ft) plus 90 degrees (1/4 turn)
Non-Plated Cap Screws		163 N·m (120 lb-ft)
Brake-to-Differential Case		
Cap Screws	Torque	130—196 N·m (96—145 lb-ft)
Brake Piston Housing-to-Brake		
Cap Screws	Torque	146—178 N·m (108—132 lb-ft)



Suggest:

If the above button click is invalid.

Please download this document

first, and then click the above link

to download the complete manual.

Thank you so much for reading

REAR DIFFERENTIAL: REMOVE PARK BRAKE

NOTE: To install a new O-ring, the differential drive shaft and bearing quill can be removed with the differential case in the unit.

1. Remove differential case (See Group 0200).
2. Remove both axles (See Group 0250).
3. Remove two cap screws (A).
4. Remove two plugs (B).

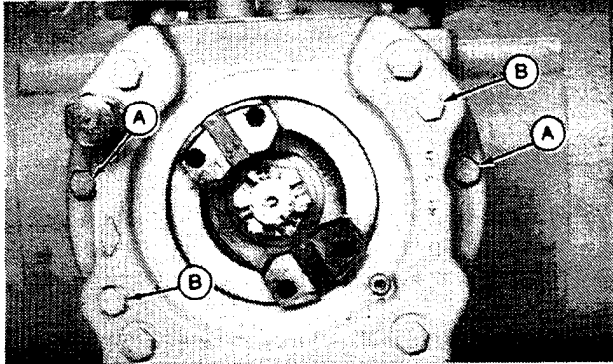

OAA;R38481 R50;50300 976 050784

5. Install two cap screws (A) that were removed into plug holes.

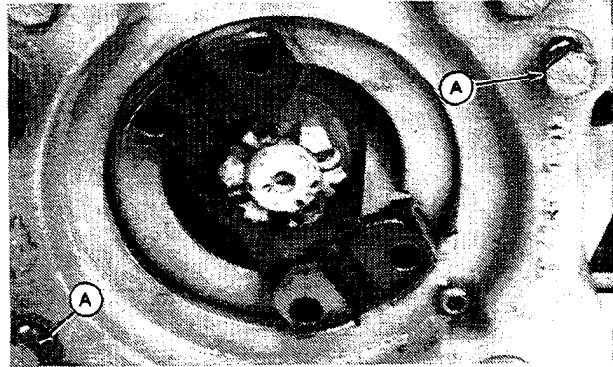

OAA;R38482 R50;50300 771 270983

<https://www.ebooklibonline.com>

Hello dear friend!

Thank you very much for reading.

Enter the link into your browser.

The full manual is available for immediate download.

<https://www.ebooklibonline.com>