

# 484 Cotton Stripper



JOHN DEERE

## TECHNICAL MANUAL 484 Cotton Stripper

TM1153 (01APR82) English

**TM1153 (01APR82)**

LITHO IN U.S.A. (REVISED)  
ENGLISH



**484 COTTON  
STRIPPER**  
Technical Manual  
TM-1153 (Apr-82)

*All information, illustrations and specifications contained in this technical manual are based on the latest information available at the time of publication. The right is reserved to make changes at any time without notice.*

Right and Left-hand  
Determination

“Right-hand” and “left-hand” sides are determined by facing in the direction the stripper will travel when in use.

Copyright © 1982 Deere & Company  
Moline, Illinois All rights reserved

Previous Editions  
Copyright © 1980 Deere & Company  
Copyright © 1979 Deere & Company  
Copyright © 1978 Deere & Company  
Copyright © 1976 Deere & Company

GENERAL 10

ENGINE 20

FUEL AND AIR SYSTEM 30

ELECTRICAL SYSTEM 40

POWER TRAIN 50

STEERING AND BRAKES 60

HYDRAULIC SYSTEM 70

STRIPPING UNITS, AIR SYSTEM, AND  
DUAL GUIDE WHEELS 80

OPERATOR'S CAB 90

ALPHABETICAL INDEX 100

## INTRODUCTION

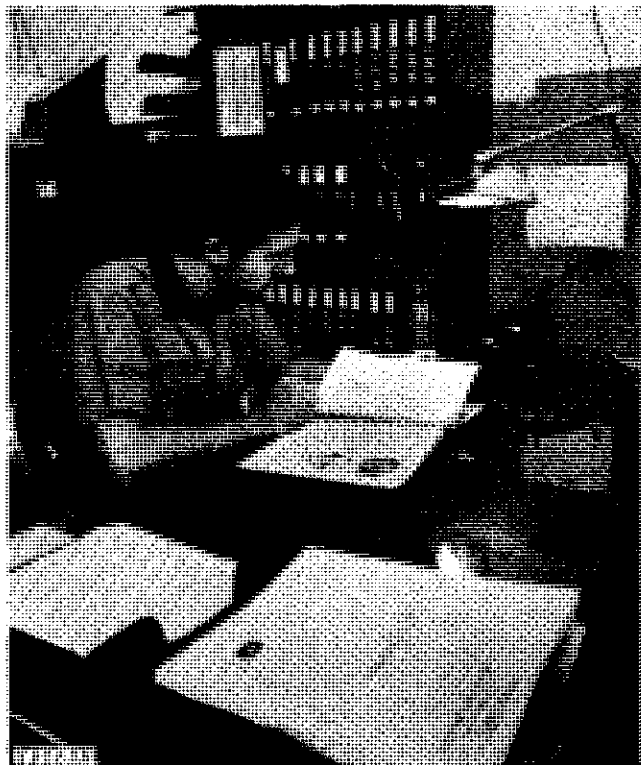

Use FOS Manuals for Reference



Use Technical Manuals for Actual Service

This technical manual is part of a twin concept of service:

- **FOS Manuals — for reference**
- **Technical Manuals — for actual service**

The two kinds of manuals work as a team to give you both the general background and technical details of shop service.

*Fundamentals of Service (FOS) Manuals cover basic theory of operation, fundamentals of trouble shooting, general maintenance, and basic types of failures and their causes. FOS Manuals are for training new personnel and for reference by experienced technicians.*

*Technical Manuals are concise service guides for a specific machine. Technical Manuals are on-the-job guides containing only the vital information needed by an experienced technician.*

*NOTE: Whenever the service technician may need to refer to a FOS Manual for additional information, a specific manual number is given.*

Some features of this technical manual:

- Sectional contents at front of manual
- Contents at front of each section
- Line drawings showing parts relationship
- Illustrations showing service techniques
- Specifications grouped at end of each section

This technical manual was planned and written for you — an experienced technician. Keep it in a permanent binder in the shop where it is handy. Refer to it whenever in doubt about correct service procedures or specifications.

Using the technical manual as a guide will reduce error and costly delay. It will also assure you the best in finished service work.

Throughout this manual dimensions are shown as follows: (1.75 mm) .069 in. the measurement in parentheses was converted from the design dimension.

### FOR YOUR CONVENIENCE

Vertical lines appear in the margins of many of the pages. These lines identify new material and revised information that affects specifications, procedures, and other important instructions.

**<https://www.ebooklibonline.com>**

Hello dear friend!

Thank you very much for reading.

Enter the link into your browser.

The full manual is available for immediate download.

**<https://www.ebooklibonline.com>**

## SAFETY AND YOU



T27999N

### INTRODUCTION

 This safety alert symbol identifies important safety messages in this manual and on the machine. When you see this symbol, be alert to the possibility of personal injury and carefully read the message that follows.

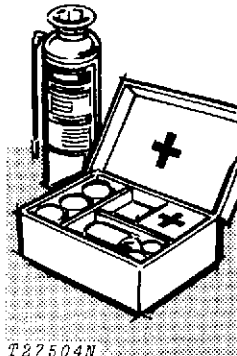

T27504N

T25704N

Be prepared if an accident or fire should occur. Learn where the first aid kit and the fire extinguishers are located—know how to use them.

### BLOCKING THE COTTON STRIPPER

T27999N

**CAUTION:** Whenever the engine is to be removed for service, it is very important that the basket be securely blocked so it will not fall and cause serious personal injury or damage to the cotton stripper.

Whenever working under the stripping units, securely block the stripping units so they will not fall and cause personal injury or damage to the units.

Always service the cotton stripper on level ground unless otherwise specified in this manual.

Block the wheels to keep the cotton stripper from moving while it is being serviced.

### MOUNTING TIRES

Failure to follow proper procedures when mounting a tire on a wheel or rim can produce an explosion which may result in serious injury or death. Do not attempt to mount a tire unless you have the proper equipment and experience to perform the job. Have it done by a qualified tire repair service.

When seating tire beads on rims, never exceed 35 psi (241 kPA) or maximum inflation pressures specified by tire manufacturers for mounting tires. Inflation beyond this maximum pressure may break the bead, or even the rim, with dangerous explosive force. If both beads are not seated when the maximum recommended pressure is reached, deflate, reposition tire, relubricate bead, and reinflate.

Detailed agricultural tire mounting instructions, including necessary safety precautions, are contained in John Deere Fundamentals of Service (FOS) Manual 55, Tire and Tracks, available through your Distribution Service Center. Such information is also available from the Rubber Manufacturers Association and from tire manufacturers.

**CLEANING THE COTTON STRIPPER**

N31129N

N31129N

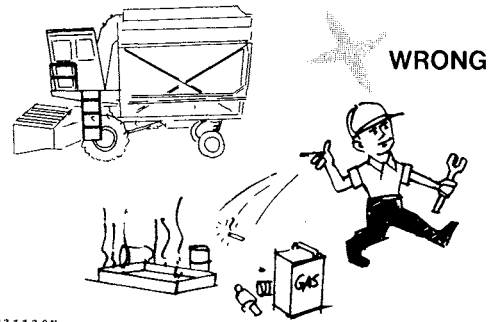
**AVOIDING FIRE HAZARDS**

N31130N

N31130N

Always stop the engine before cleaning the cotton stripper.

Keep the operator's platform clean. Do not use it as a storage area.

Keep the radiator and engine closure screens free of foreign matter. Avoid a possible fire hazard.

Keep all equipment free of dirt and oil. In freezing weather, beware of snow and ice on ladder steps and operator's platform.

**SERVICE AREA RECOMMENDATIONS**

Keep the service area clean and dry. Wet or oily floors are slippery. Wet spots can be dangerous when working with electrical equipment.

Make sure the service area is adequately vented.

Periodically check the shop exhaust system for leakage. Engine exhaust gas is dangerous.

Be sure all electrical outlets and tools are properly grounded.

Use adequate light for the job at hand.

Use lifting equipment and safety stands which have adequate strength for the job being performed.

Don't smoke while refueling or handling highly flammable material.

Stop the engine when refueling.

Use care in refueling if the engine is hot.

Don't use open pans of gasoline or diesel fuel for cleaning parts. Good commercial, nonflammable solvents are preferred.

Provide adequate ventilation when charging batteries.

Don't check battery charge by placing metal objects across the posts.

Don't allow sparks or open flame near batteries.

Don't smoke near battery.

Never check fuel, battery electrolyte or coolant levels with an open flame.

Never use an open flame to look for leaks anywhere on the equipment.

Never use an open flame as a light anywhere on or around the equipment.

When preparing engine for storage, remember that inhibitor is volatile and therefore dangerous. Seal and tape openings after adding the inhibitor. Keep container tightly closed when not in use.

## PERSONAL SAFETY



Always avoid loose clothing or any accessory — lopping cuffs, dangling neckties and scarves — that can catch in moving parts and put you out of work.

Always wear your safety glasses while on the job.

Keep transmission and brake control units properly adjusted at all times. Before making adjustments, stop engine.

Before removing any housing covers, stop engine. Take all objects from your pockets which could fall into the opened housings. Don't let adjusting wrenches fall into opened housings.

Don't attempt to check belt tension while the engine is running.

Don't adjust the fuel system while the machine is in motion.

Before repairing the electrical system, or performing a major overhaul, make sure the batteries are disconnected.

Avoid working on equipment with the engine running. If it is necessary to make checks with the engine running, ALWAYS USE TWO PEOPLE — with the operator, at the controls, able to see the person doing the checking. Also, put the transmission in neutral, set the brake, and apply any safety locks provided. KEEP HANDS AWAY FROM MOVING PARTS.

Use extreme caution in removing radiator caps, drain plugs, grease fittings, or hydraulic pressure caps.

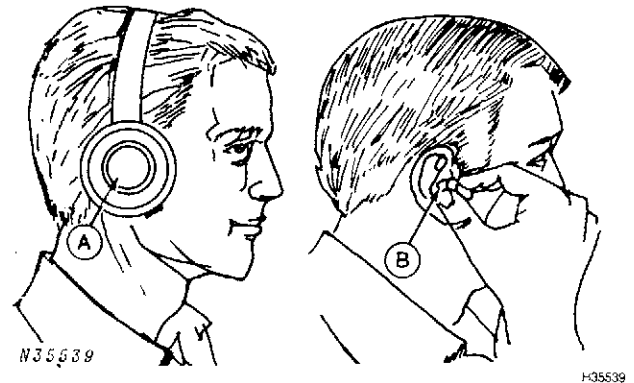

Prolonged exposure to loud noise can cause impairment or loss of hearing.

Wear a suitable hearing protective device such as earmuffs (A) or earplugs (B) to protect against objectionable or uncomfortable loud noises.

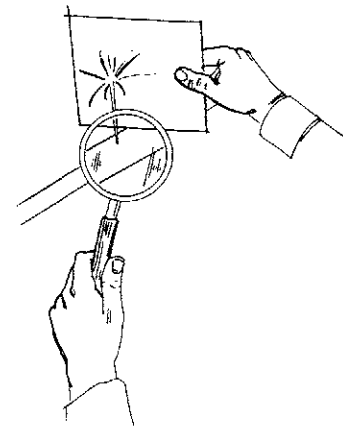

Escaping fluid under pressure can have sufficient force to penetrate the skin, causing serious injury. Before disconnecting lines, be sure to relieve all pressure. Before applying pressure, be sure all connections are tight and lines, pipes and hoses are not damaged. Use a piece of cardboard or wood rather than hands, to search for leaks.

If injured by escaping fluid, see a doctor at once. Serious infection or reaction can develop if proper medical treatment is not administered immediately.

# Section 10 GENERAL

## CONTENTS OF THIS SECTION

	Page		Page
GROUP 5 - SPECIFICATIONS		GROUP 15 - TUNE-UP AND ADJUSTMENT	
Description .....	5-1	General Information .....	15-1
Specifications .....	5-2	Preliminary Engine Testing .....	15-1
GROUP 10 - PREDELIVERY, DELIVERY, AND AFTER SALE SERVICE		Engine Tune-Up .....	15-1
Predelivery Service .....	10-1	Final Engine Testing .....	15-3
Delivery Service .....	10-19	Cotton Stripper Adjustment .....	15-4
After Sale Inspection .....	10-20	Standard Torque Chart .....	15-4
		GROUP 20 - LUBRICATION	
		Lubricants .....	20-1

## Group 5 SPECIFICATIONS

### DESCRIPTION

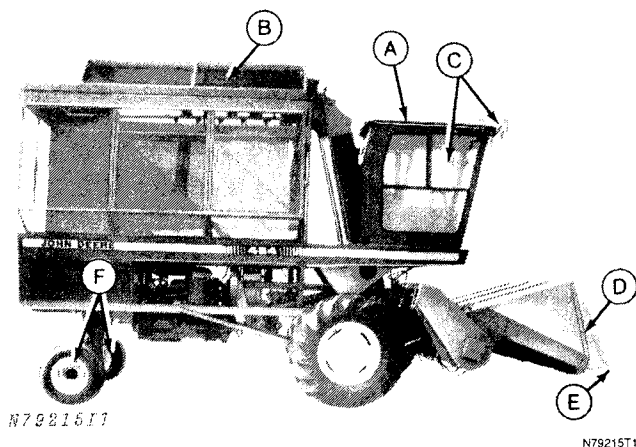

- A—SOUND-GARD® Style Cab (No ROPS)
- B—Basket
- C—Rear View Mirrors
- D—Stripping Units
- E—Height Sensing Shoes
- F—Dual Guide Wheels

Fig. 1-484 Cotton Stripper

The 484 Cotton Stripper is a self-propelled machine, consisting of the following basic components:

1. Operator's Station, Controls, and Instruments.
2. Stripping Units.
3. Air System and Basket.
4. Engine and Propelling Mechanism.

The operator is above the stripping operation when at the controls of the cotton stripper. All controls are within easy reach of the operator.

The stripping units are adjustable for various row spacings. Large strip rolls with alternating rubber flaps remove a maximum of cotton with a minimum of leaves and bark from the cotton plant.

The large-volume, high capacity air system, with its green boll separation, allows practically unlimited ground speed in high yielding cotton. A green boll box located directly below the air system duct, allows dumping of bolls at row ends from the operator's platform.

The cotton stripper is propelled by a 6-cylinder, rear-mounted, diesel engine.

*NOTE: All references in this manual to front, rear, left-hand and right-hand are in relation to the position of the operator seated on the operator's platform.*

### SERIAL NUMBERS

The cotton stripper serial number plate is located on the left-hand platform support.

The engine serial number plate is located on the left-hand side of the engine block.

The hydrostatic pump and motor serial number plates are located on the pump and motor.

The stripping head serial number plate is located on the left-hand side of the frame.

The cab serial number plate is located to the left of the operator's seat, on the cab frame.

## SPECIFICATIONS

## STRIPPING UNITS—BRUSH

Number of Units .....	4
Number of Rolls per Unit .....	2
Type of Rolls .....	Alternate Brush and Rubber Flap
Diameter of Brushes .....	6 inches (152 mm)
Length of Rolls .....	40 inches (1 016 mm)
Roll Spacing .....	Floating Type with Stop Bolt Height Adjustment
Cross Conveyor .....	12-inch (305 mm) wide Auger Housing
Height Control .....	Automatic, with Manual Override Lift and Individual Height Control Levers
Number of Augers per Unit .....	2, 6-inch (152 mm) diameter
Row Widths .....	30 to 40-inch (0.76 - 1.0 m) rows (30-inch [0.86 m] rows requires belts attachment bundle)

NOTE: 30 to 32-inch (0.76 to 0.81 m) width in skip-row cotton only (requires extension attachment bundle)

FINGERHEAD .....	56 fingers; 154 inches (3 912 mm) wide, for eight 20-inch (52 cm), five 30-inch (76 cm), or four 40-inch (102 cm) single or double rows
------------------	---

GROUND SPEEDS (Maximum at rated engine speed)	Forward		Reverse	
	Thru 1980	1981 and up	Thru 1980	1981 and up
1st Gear .....	2.7 mph (4.3 km/h)	2.9 mph (4.66 km/h)	1.4 mph (2.3 km/h)	1.5 mph (2.40 km/h)
2nd Gear .....	5.5 mph (8.9 km/h)	5.8 mph (9.33 km/h)	2.7 mph (4.3 km/h)	2.9 mph (4.66 km/h)
3rd Gear .....	7.4 mph (11.96 km/h)	7.9 mph (12.71 km/h)	3.7 mph (6.0 km/h)	4.0 mph (6.40 km/h)
4th Gear .....	14.9 mph (24.0 km/h)	15.8 mph (25.42 km/h)	7.5 mph (12.0 km/h)	7.9 mph (12.71 km/h)

## CAPACITIES

Cotton Basket	
Standard .....	608 cu. ft. (17.2 m <sup>3</sup> )
With extension .....	758 cu. ft. (21.5 m <sup>3</sup> )
Fuel Tank .....	69 U.S. gals. (261 L)
Cooling System .....	28 U.S. qts. (26.5 L)
Engine Crankcase .....	10 U.S. qts. (9.5 L) (329 Engine) 12 U.S. qts. (11.4 L) (359 Engine)
Hydraulic System .....	21 U.S. qts. (19.9 L)
Reservoir .....	15.2 U.S. qts. (14.4 L)
Transmission .....	18 U.S. qts. (17.0 L)
Final Drives .....	2 U.S. qts. (1.9 L) (Each)
Hydrostatic Drive System .....	27 U.S. qts. (25.6 L)
Reservoir .....	18.4 U.S. qts. (17.4 L)

## COOLING SYSTEM

Type .....	Liquid, Pressurized
Radiator Pressure Cap .....	7 psi (50 kPa [0.5 bar])
Thermostat .....	195°F (91°C) (329 Engine), (2) 180°F (82°C) (359 Engine)

SHIPPING WEIGHTS

484 Cotton Stripper Chassis, less Stripping Unit . . . . .	11,210 lbs. (5 085 kg)
Brush Units and Cross Auger . . . . .	3,210 lbs. (1 456 kg)
Basket Extension Attachment . . . . .	315 lbs. (143 kg)
Finger Head . . . . .	2,250 lbs. (1 021 kg)

TIRES

	Type	Pressure,psi (kPa)
Front Drive Wheels . . . . .	16.9-26, 8 PR Tractor	22 (152)*
	18.4-26, 8 PR Tractor	20 (138)
Rear Guide Wheels . . . . .	11L-15, 8 PR Implement	36 (248)
	12.5L-15, 6 PR Implement	36 (248)

\*24 (165) in right-hand tire only, with extension.

GREEN BOLL BOX . . . . . Paddle Leveling, Hydraulic Dump

BASKET DUMPING HEIGHT . . . . . 12 feet (3 658 mm)

ENGINE

	Early Models	Late Models
Manufacturer . . . . .	John Deere	
Fuel Type . . . . .	Diesel	
Model . . . . .	6329DN-03	6359DN-01
No. of Cylinders . . . . .	6	
Bore . . . . .	4.02 in. (102 mm)	4.19 in. (106.5 mm)
Stroke . . . . .	4.33 in. (110 mm)	
Displacement . . . . .	329 cu. in. (5 391 cm <sup>3</sup> )	359 cu. in. (5 883 cm <sup>3</sup> )
Flywheel Power (@ 2500 rpm, without fan) . . . . .	105 hp (78 kW)	114 hp (85 kW)
Compression Ratio . . . . .	16.8 to 1	
Tappet Clearance		
Intake . . . . .	0.014 in. (0.36 mm)	
Exhaust . . . . .	0.018 in. (0.46 mm)	
Valve Location . . . . .	Valve-in-head	
Firing Order . . . . .	1-5-3-6-2-4	
Governor . . . . .	Integral with Fuel Injection Pump	
Fuel System		
Make of Fuel Injection Pump . . . . .	Roosa Master, Type JDB	
Make of Injection Nozzles . . . . .	Roosa Master	
Type of Fuel . . . . .	No. 1-D or No. 2-D Diesel Fuel	
Fuel Filter . . . . .	Combination Element	
Electrical System . . . . .	12-volt, Alternator with Electronic Voltage Regulator, negative ground	
Air Cleaner . . . . .	Dry-type filter element, with safety element and Pre-Screener (Optional Pre-Screener extension)	
Engine Speeds		
Fast Idle (No Load) . . . . .	2650-2670 rpm	
Rated (Under Field Load) . . . . .	2500 rpm	
Slow Idle . . . . .	790-810 rpm	
Oil Filter . . . . .	Spin-on, full flow	

OPERATOR'S CAB

Type . . . . .	SOUND-GARD (with no ROPS), with heater and windshield wiper
Optional Attachments . . . . .	Rear View Mirror, Air Conditioner, Seat Suspension, Seat Belts.

## DIMENSIONS

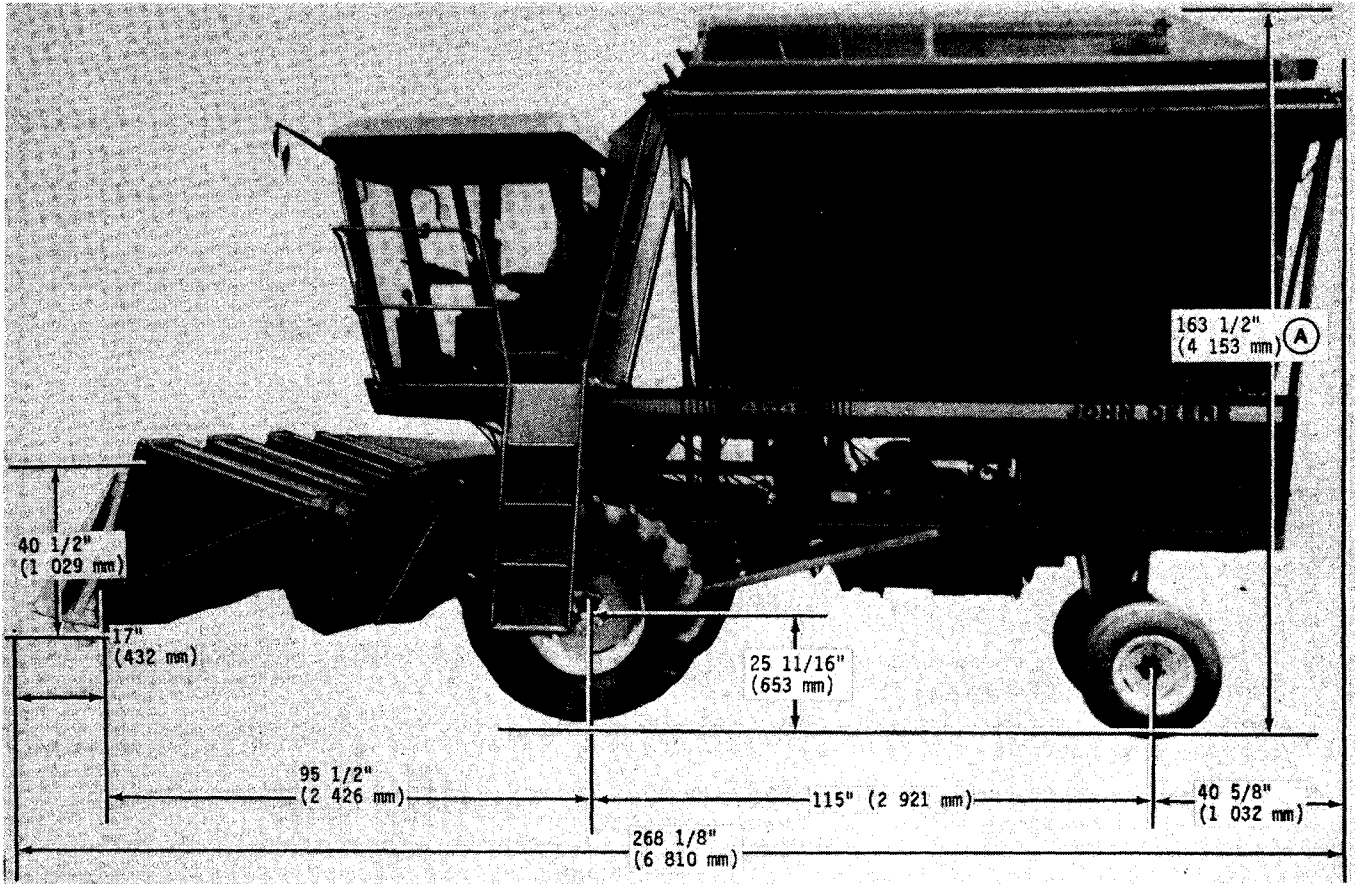

Fig. 2-Left-Hand Side View

N79215J3

## NOTES:

A—With basket extension, 181-1/2 inches (4 610 mm)

B—Adjustable from 71-5/8 to 92-5/8 inches (1 819 to 2 352 mm).

C—Without unit extension 163-1/2 inches (4 153 mm)

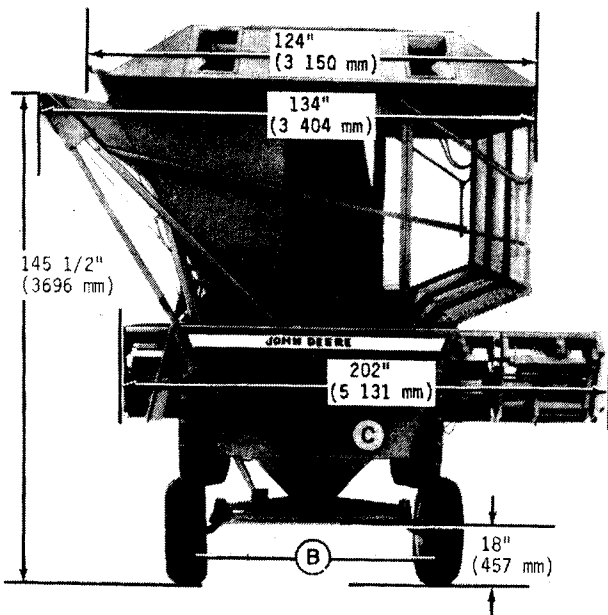

Fig. 3-Rear View (with unit extension)

N77334D3

# Group 10 PREDELIVERY, DELIVERY, AND AFTER SALE SERVICE

## PREDELIVERY SERVICE

The John Deere Delivery Receipt, when properly filled out and signed by the dealer and customer, verifies that the predelivery and delivery services were satisfactorily performed. When delivering this machine, give the customer his copy of the delivery receipt and the operator's manual. Explain their purpose to him.

### Prestarting Checks

1. Check the stripper for any observed shortage, loss, or damage. If any is noted, make the proper notations on the freight bill and immediately notify the carrier.

2. Remove banding and shipping board from battery and attach positive cable to battery terminal.

3. Remove blocking and wiring holding stripper to flat car during shipment, and securing cab door.

4.  **CAUTION: Remove tie-down plate from drive wheels and install bolts. Torque ALL drive wheel lug bolts to 160-200 ft-lbs (220-270 N·m). Torque guide wheel lug bolts to 110-140 ft-lbs (150-190 N·m). Discard blocks, wire, tie-down straps, and bolts.**

5. Check engine oil level with the crankcase dipstick. The stripper is shipped with John Deere TORQ-GARD SUPREME® SAE 10W-20 oil in the engine crankcase. If necessary, add equivalent engine oil until oil level is at the "full" mark on the dipstick.

6. Remove the filler cap on the hydraulic system fluid reservoir and check oil level on the dipstick. If oil level is low, check for possible leaks or loose connections in the hydraulic system. If necessary, add John Deere HY-GARD® hydraulic oil or equivalent, or an API Service SD or CD engine oil, until oil level is at the "full" mark on the dipstick.

7. Check lubricant level in transmission, and if necessary add lubricant until it reaches level plug.

**IMPORTANT: Use ONLY API Service GL-5 (MIL-L2105B) SAE 85W-140 gear lubricant in this transmission. Do not overfill transmission. Remove level plug and allow sufficient time for oil to "level out" within the housings. Replace plug AFTER any excess oil has drained off.**

8. Check the hydrostatic reservoir oil level in the sight glass. If oil level is low, add John Deere All-Weather Hydrostatic Fluid or Texaco Texamatic Type F-1876 Transmission Fluid until the oil reaches the sight glass. Replace filler cap.

**IMPORTANT: Keep system tightly closed at all times, except when adding fluid. DO NOT OVERFILL.**

9. Check radiator coolant level. The stripper is shipped from the factory with an ethylene glycol antifreeze solution in the radiator—protecting the cooling system to minus 34°F (-37°C).

**IMPORTANT: Do not use antifreeze which contains stop leak additives.**

10. Check the transmission and final drive housing for oil leaks.

11. Remove sealing material from the following locations (if stripper has been in storage):

- Fuel tank cap (tape).
- Exhaust pipe (cap plug).
- Air cleaner precleaner screen (poly bag).
- Crankcase breather tube (poly bag).
- Hydraulic oil reservoir filler cap (poly bag).

*NOTE: Plastic plug and bags may be reused when stripper is stored.*

## Prestarting Checks—Continued

12. Check tire air pressures and adjust as necessary according to the following chart. Use an air-liquid gauge to test drive wheel pressures, with valve stem at bottom of rim.

**CAUTION:** Observe precautions provided by chemical manufacturer when working with solutions containing chemicals.

\*TIRE INFLATION CHART

Wheel	Type of Tire	Tire Size	Inflation Pressure psi (kPa)
Drive Wheels*	Bar	18.4-26 8-ply rating	**20 (138)
Guide Wheels	Low Profile	12.5L-15 8-ply rating	36 (248)

\*Each drive wheel tire is filled to valve stem level with chromated calcium chloride solution, in a concentration of 5 pounds (2.3 kg) of chromated calcium chloride in enough water to form 5 quarts (4.7 L) of solution.

\*\*If stripper is equipped with row-unit extension, inflate right-hand tire to 24 psi (165 kPa).

13. Remove protective material from steering column.

## Removing Stripper From Flat Car

1. Make sure the brakes are working before attempting to remove stripper from flat car.

2. Start the engine and drive the stripper to the loading dock or ramp and onto level ground.

**CAUTION:** Drive slowly and carefully to avoid accidents and damage to the stripper.

3. Unwire unit drive shaft rear section from duct support frame and attach to unit countershaft spline.

4. Remove stripping unit from flat car with fork lift or hoist.

5. Attach stripping unit to chassis (see "Service" section of operator's manual) and remove the shipping board.

6. Remove wire holding lid linkage to basket frame and lid grates to lid for shipping purposes.

## Basket Shipping Bolts and Lid Linkage

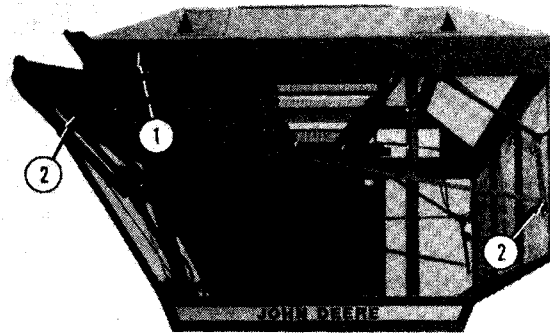

N79215P2

Fig. 1-Installing Lid Linkage

**1. IMPORTANT:** Remove the two red bolts which hold the basket lid to the basket frame. These bolts are reached from inside the basket and are flagged by the red metal tag at the front and rear of the basket. Extensive damage will result if the basket is raised with the red shipping bolts in place and lid linkage connected.

2. Remove wire holding lid linkage in shipping position. Install pivot bolts, from INSIDE basket support frames, through link, with a nut on each side of support, to allow link to pivot freely. Use outer hole in long link when attaching to short link, for standard lid opening. Use inner hole for larger lid opening.

## Basket Control Linkage

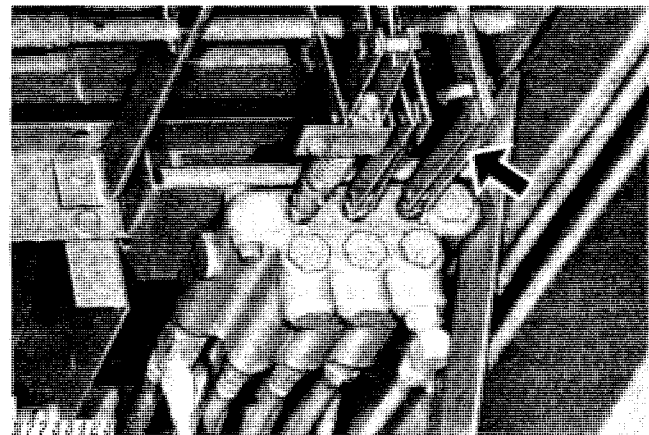

N77334E3

Fig. 2-Installing Basket Control Linkage

Connect basket control linkage at the valve under the platform as shown (Fig. 2).

## CHECKS AND ADJUSTMENTS

Start engine and check operation of the instruments. Allow engine to operate at moderate speed until operating temperature is reached.

### Checking Instrument and Gauges

Check the oil pressure and hydrostatic oil temperature tel-lights, water temperature gauge, and voltmeter to make sure that they are functioning properly. If not, stop the engine immediately and determine the cause.

### Oil Pressure Tel-Light

If the light stays on while the engine is running, the engine oil pressure is too low. Check and add oil or change to correct type of oil. If light remains on with adequate supply of oil, refer to Section 20, "Engine" and Section 40, "Electrical".

*NOTE: If the oil pressure light does not come on with the ignition switch on, before starting the engine, the bulb may be burned out. Replace it before proceeding to start the engine.*

### Hydrostatic Oil Temperature Tel-Light

Indicates hydrostatic oil temperature. If light comes on, oil temperature is too high. Stop engine and determine cause. Refer to Section 50, Group 30, "Hydrostatic Drive".

### Engine Coolant Temperature Gauge

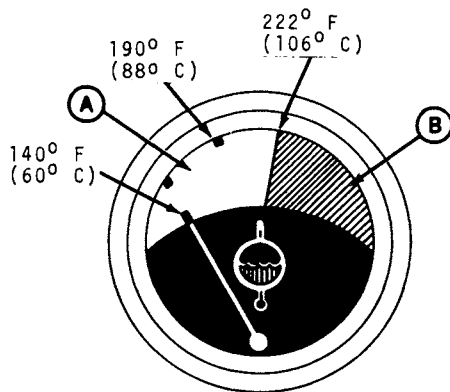

N27361

N27361

A—Operating Range

B—Overheat Range

Fig. 3-Water Temperature Gauge

Indicates the engine coolant temperature. Normal operating temperature is 180 to 210°F (82-95°C). If indicator reaches red band on dial, stop engine and determine cause. Refer to Section 20, "Engine".

## Voltmeter

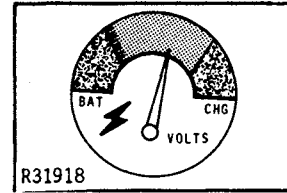

Fig. 3A-Voltmeter

R31918

Voltmeter (Fig. 3A) pointer should rise to the green band, when the key switch is turned clockwise to the first position, indicating a charged battery; and register higher with the engine running, indicating that alternator is charging. If not, refer to Section 40, "Electrical System".

### Other Instruments and Gauges

Observe operation of remaining instruments and gauges for proper function. If any are inoperative, refer to Section 40, "Electrical".

## CHECKS AND ADJUSTMENTS—Continued

### Checking Engine Speeds (No Load)

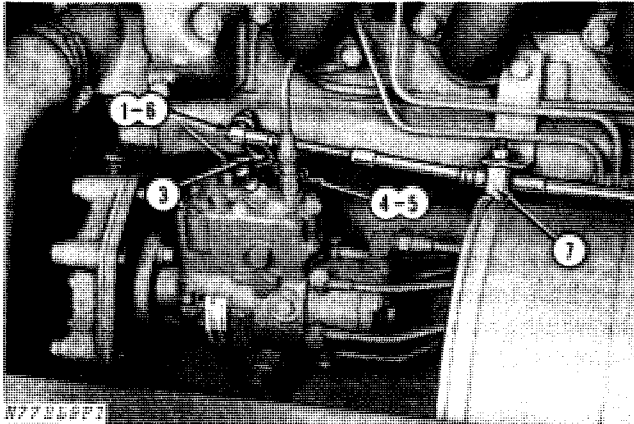

Fig. 4-Injection Pump Adjustments

N77259F1

- Remove console cover and adjust fast idle stop bolt (Fig. 5) so tachometer reads  $2660 \pm 10$  rpm when throttle is fully forward.

### Slow Idle

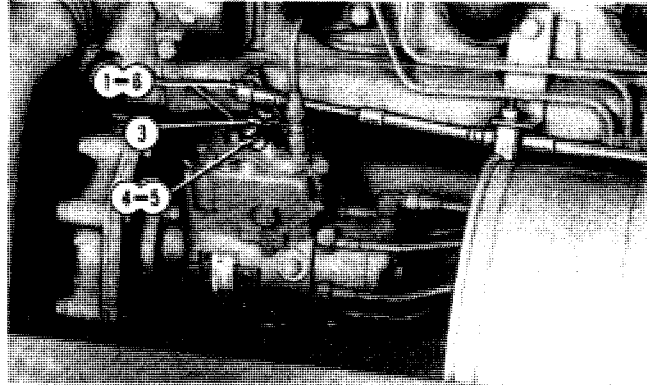

Fig. 5A-Injection Pump Adjustments

N77259F5

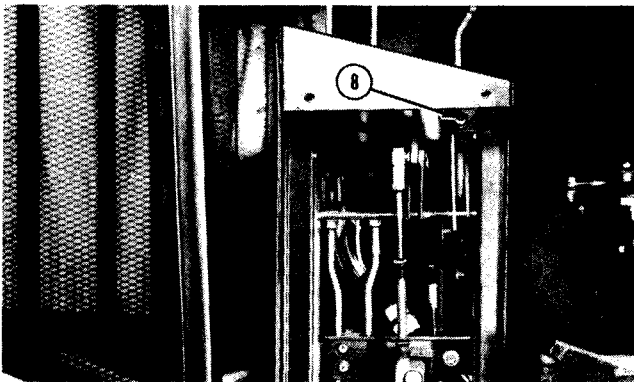

Fig. 5-Stop Bolt Adjustment

N80280H1

### Fast Idle

- Disconnect speed control cable from injection pump throttle lever (Fig. 4).
- Start engine.
- Have a second person move pump throttle lever toward flywheel as far as it will go. Tachometer should read  $2660 \pm 10$  rpm.
- To adjust: Cut safety wire securing fast idle cap, then unscrew cap. Turn the fast idle screw with an Allen wrench to set recommended rpm.
- Replace cap and install new safety wire.
- Adjust ball joint so it slips easily into throttle hole, then install lock nut.
- Additional adjustment can be made, if needed, with cable clamp.

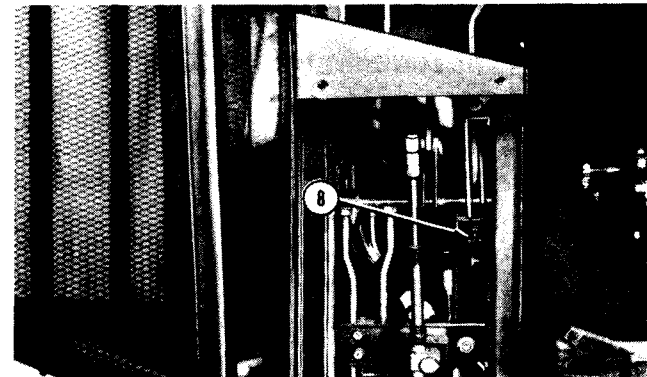
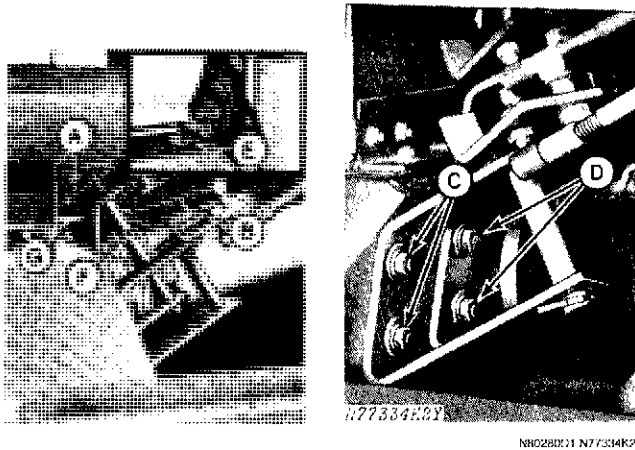

Fig. 5B-Stop Bolt Adjustment

N80280H2

- Disconnect speed control cable trunnion from injection pump throttle lever (Fig. 5A).
- Start engine.
- Have a second person move pump throttle lever toward radiator as far as it will go. Tachometer should read  $800 \pm 10$  rpm.
- To adjust: Loosen lock nut and turn slow idle screw to set recommended rpm.
- Tighten lock nut.
- Adjust trunnion so it slips easily into throttle hole, then install lock nut.
- Additional adjustment can be made, if needed, with cable clamp.
- Remove console cover and adjust slow idle stop bolt (Fig. 5B) in console so tachometer reads  $800 \pm 10$  rpm when throttle is fully back.

## Fan and Stripping Unit Drive Belts



- A—Stripping Unit Rod
- B—Fan Rod
- C—Stripping Unit Bracket Bolts
- D—Fan Bracket Bolts
- E—Idler Stop
- F—Spring
- G—Filler Bracket

Fig. 6-Fan and Unit Drive Belts

Tighten either belt by rotating the rod (A or B) after first loosening the lock nuts. Each rod has right and left-hand threads.

The belts can also be tightened by loosening attaching bolts (C or D) and moving the bracket to the right.

Adjust stop (E) so belt just disengages, but remains in drive sheave.

If further adjustment is needed, increase spring (F) tension by pivoting filler bracket (G) in slot.

## Fan Belt Keeper

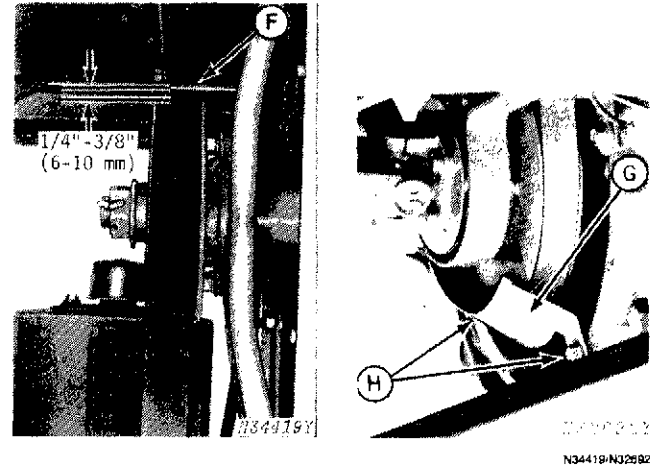

- F—Top Keeper
- G—Bottom Keeper
- H—Adjusting Bolts

Fig. 7-Fan Belt Keepers

Adjust both top and bottom belt keepers (F and G) 1/4 to 3/8-inch (6 mm to 10 mm) from fan belt when engaged.

## Unit and Cross Auger Belts

The right-hand unit belt is tightened when the cross auger belt is tightened. The middle and the left-hand unit belts are tightened by one adjusting bolt on the left-hand side of the stripper. Check tension, and adjust as follows, if necessary.

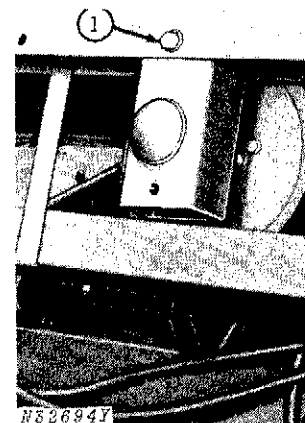
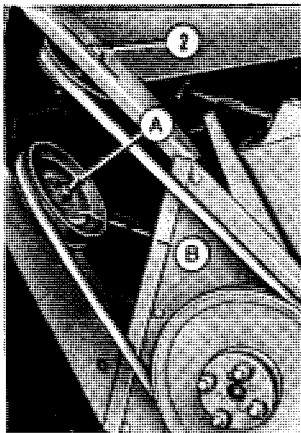

Fig. 8-Pivot Bolt

1. To tighten the right-hand unit belt, first loosen the pivot bolt.

## CHECKS AND ADJUSTMENTS—Continued



A—Sheave Bolt

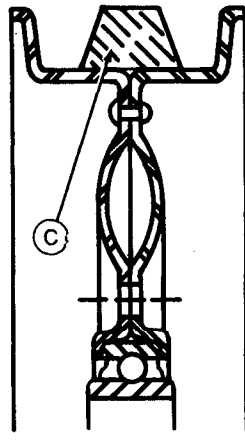

B—Lower Idler  
C—Cross Auger Belt

Fig. 9-Adjusting Belt

2. Loosen idler sheave bolt, slide the sheave up to tighten belts, and tighten bolt. This tightens BOTH the cross auger and unit belts.

**NOTE:** To tighten only the cross auger belt, do not loosen pivot bolt in step 1.

**IMPORTANT:** Cross auger belt must run true in its directional sheave. Adjust, if necessary, as follows:

- Loosen sheave bolt (A) on lower idler.
- Position wrench on hex spacer under lower idler (B).
- Rotate hex spacer until cross auger belt (C) tracks in the center of the idler sheave.
- Tighten sheave bolt.

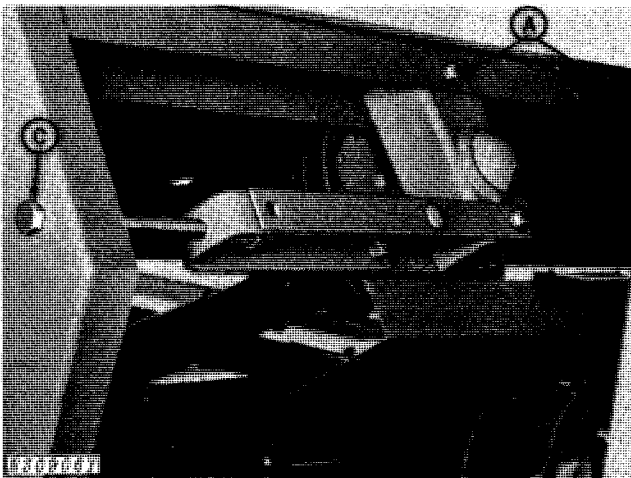

C—Left-Hand Side Adjusting Bolt

Fig. 10-Adjusting Bolt

The adjusting bolt (C, Fig. 10) tightens both the middle and left-hand unit drive belts. Turn the bolt clockwise to tighten and counterclockwise to loosen the unit drive sheave housing pivot bolt (A) of both units.

After proper belt tension is achieved with the adjusting bolt, tighten both pivot bolts.

### Alternator Drive Belt

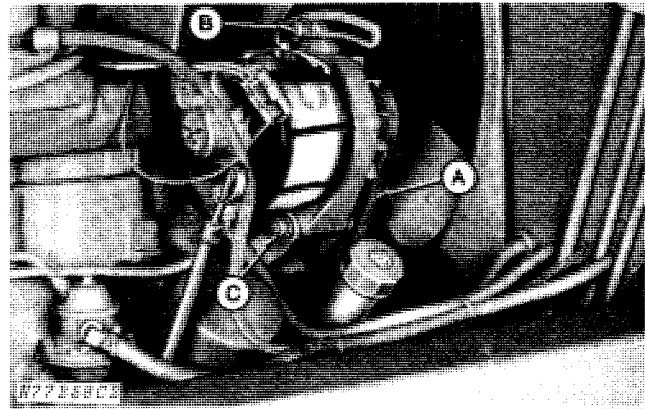

A—Belts B—Adjusting Screws C—Pivot Bolt

Fig. 11-Alternator

The alternator drive belts must be sufficiently tight to properly charge the battery. Tighten the belts by first loosening the adjusting screw (B, Fig. 11) and pivot bolt (C). Pull and hold the alternator AWAY from the engine, then tighten the adjusting screw. After checking belt tension, tighten the pivot bolt.

### Air Conditioner Compressor Drive Belt

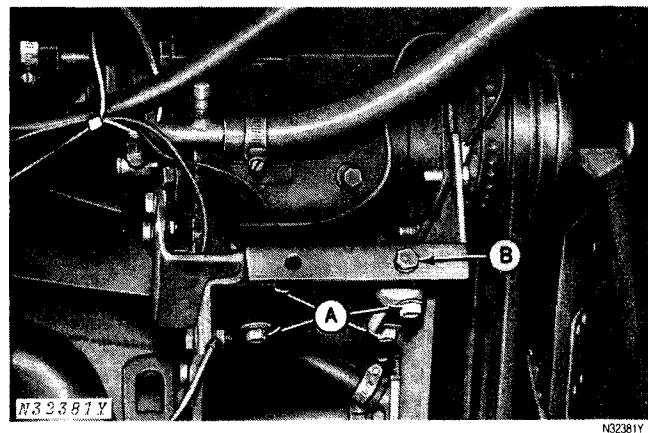

A—Mounting Bolts B—Adjusting Bolt

Fig. 12-Air Conditioner Belt

Loosen mounting bolts (A, Fig. 12). Turn adjusting bolt (B) clockwise. Tighten mounting bolts.

## Boll Box Drive Belt

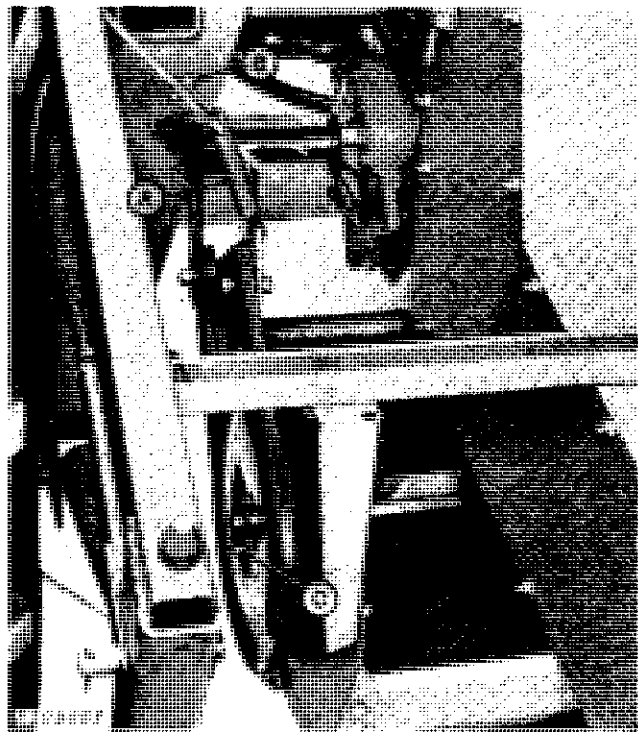

A—Spring  
B—Adjusting Bracket Bolt  
C—Adjusting Screw

Fig. 13-Boll Box Drive Belt (Shield Removed)

The boll box drive belt is constantly engaged if the spring (A, Fig. 13) is connected and the set screws in the drive sheave are tight. If necessary to increase belt tension, loosen the bracket bolt (B) and turn the bracket up, then tighten the bracket bolt.

## Hydraulic Pump Drive Belt



A—Lower Jam Nut  
B—Upper Jam Nut  
C—Pivot Bolt

Fig. 14-Adjusting Hydraulic Pump Drive Belt

The drive belt is adjusted properly if the belt does not slip when the pump is in relief.

To adjust, loosen the pivot bolt (C, Fig. 14). To increase tension, loosen upper jam nut (B) and tighten lower jam nut (A). To decrease tension, loosen lower jam nut and tighten upper jam nut.

## Slip Clutches

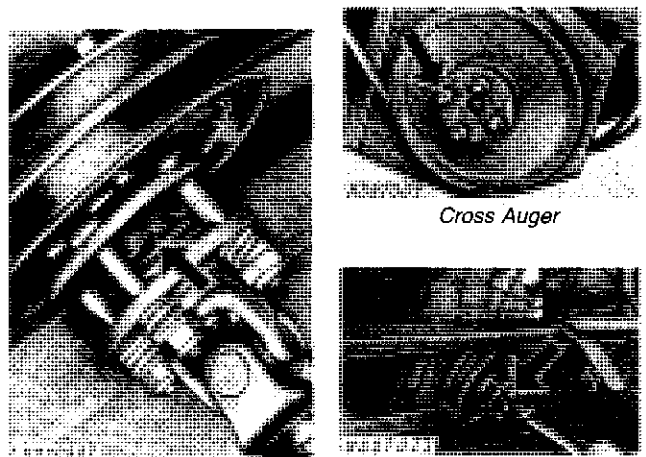

Widest Separation  
Row Unit  
Fig. 15-Slip Clutches

The slip clutches (Fig. 15) are designed to slip when a row unit or the cross auger encounter an obstruction that applies 60-100 ft-lbs (82-136 N·m) to it.

**IMPORTANT: Adjust the clutch any time it slips excessively, or after disassembly. DO NOT OVERTIGHTEN, TO AVOID DAMAGE TO COMPONENTS.**

To adjust the clutch, first loosen the four lock nuts, but do not completely remove them. Turn the outer jaw so it is at its widest separation. Tighten down each lock nut until all springs are solid height, then back off TWO COMPLETE turns.

If clutch still slips, tighten all four springs a quarter turn at a time, but NEVER completely compress springs or protection will be eliminated.

## CHECKS AND ADJUSTMENTS—Continued

### Brakes



Fig. 17-Pedal Travel

Brake pedals should have 2 to 3-1/2-inches (51 to 89 mm) free travel. Make sure stripper will roll free and brakes do not heat.

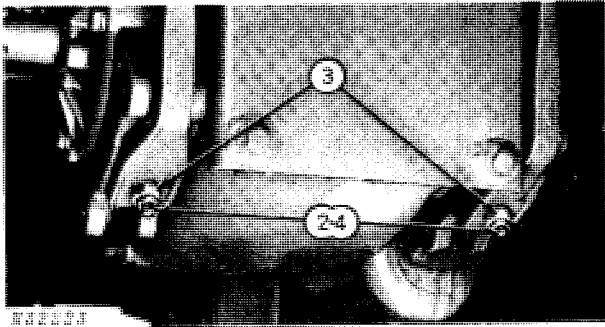
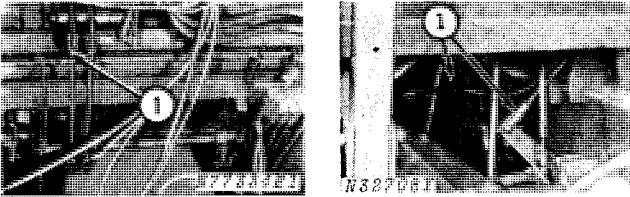

To adjust:

1. Remove slack from brake linkage by adjusting yoke on either front or rear rod.
2. For additional adjustment, loosen lock nuts.
3. Turn adjusting nuts until free travel is obtained.
4. Tighten lock nuts.

Brake pedals **MUST BE** aligned when brakes are applied. Equalize them by increasing the free travel on the one having the least free travel.

### Safety Start Switches

If starter will not operate with transmission, unit lift, and boll box door levers in "neutral", check safety start switches as follows:

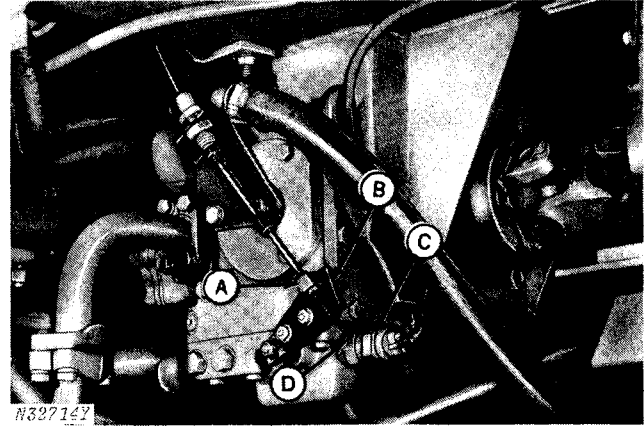

A—Trunnion  
B—Arm  
C—Switch  
D—Set Screws

Fig. 19-Safety Start Switch

1. Disconnect one of the two wires from the safety start switch (C, Fig. 19).
2. Loosen set screw (D).
3. Position speed range lever in neutral and turn key switch "ON".
4. Connect a 12 volt D.C. test lamp or an ohm meter to the two terminals on switch. The switch is correctly positioned when the lamp lights, or "O" resistance is indicated. Additional check: the lamp is not lit, or an "open" line is indicated, when lever is moved out of neutral.

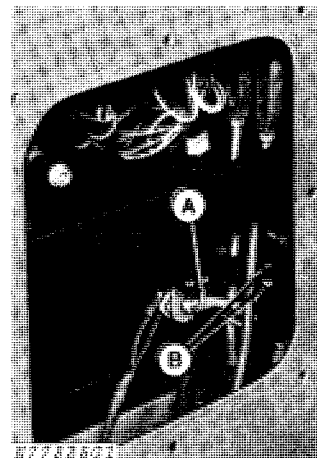

A—Arm  
B—Attaching Bolts

Fig. 19A—Safety Start Switch

If the arm is not pivoting down far enough, loosen switch bracket attaching bolts (B, Fig. 19A) and move the bracket up. Tighten bolts.

## Steering System

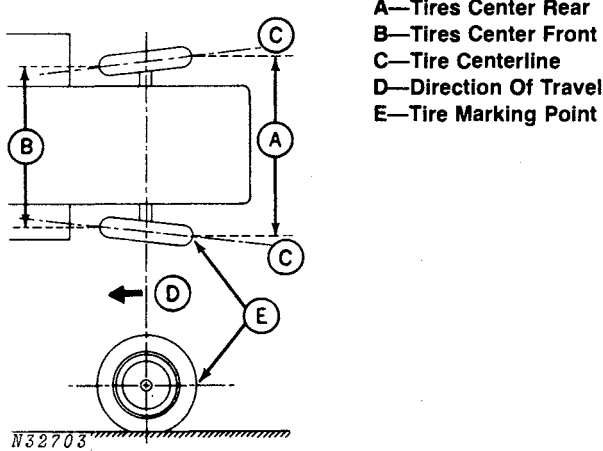

Fig. 20-Checking Toe-in

If guide wheels are not "tracking" cleanly during turns, check toe-in as follows.

1. Mark center of each tire tread at rear in line with axle. Measure distance (A, Fig. 20) between these two marks.
2. Move stripper forward until marks on tires are at front in line with axle.
3. Measure distance between marks again as shown by (B). Dimension (B) should be 3/8 inch (10 mm) less than (A).

If adjustment is required, refer to page 80-15-3.

## Lights and Wiring

Turn the ignition switch on and check the headlights, tail lights, and warning lights. These are controlled by the light switch.

W-Warning lights flashing

H-Headlights, tail lights, warning lights

F-Tail lights, headlights

With the ignition switch on and the light switch on "H", press the dimmer switch on the operator's platform to check the dim and bright positions (Fig. 21).

**NOTE:** Both high and low beams of headlights should function on "HI" position of dimmer switch, low beams only should function in the other position.

## Adjusting Headlights

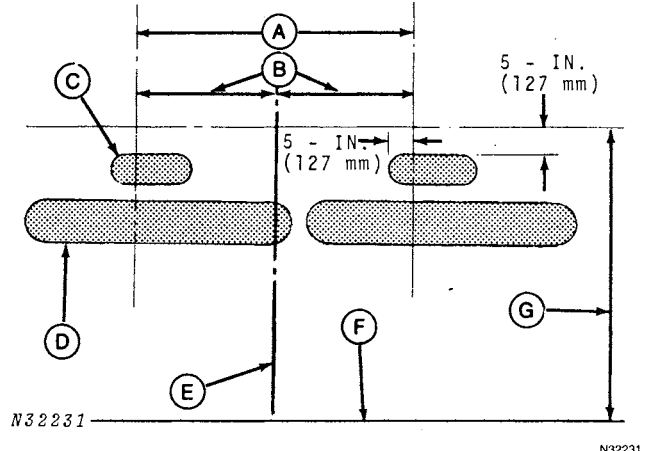

- |  |  |
|--|--|
| A—Distance between lamp centers        | D—Lower light zone at 25 ft (7 620 mm) |
| B—Equal distances                      | E—Center of machine                    |
| C—Upper light zone at 25 ft (7 620 mm) | F—Ground level                         |
|  | G—Lamp height above ground             |

Fig. 21-Headlights Pattern

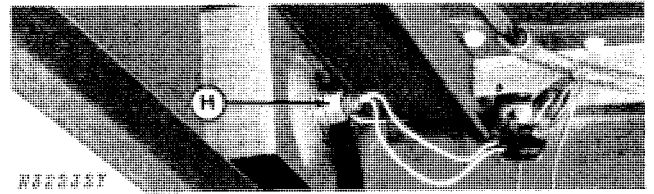

H—Adjusting Nut

Fig. 22-Headlights Adjustment

**CAUTION:** Adjust lights so they are not objectionable to oncoming traffic.

1. Turn lights on low beam, with dimmer switch and adjust the upper zone as shown.
2. Loosen adjusting nut (H) under platform to aim light, then tighten.

## CHECKS AND ADJUSTMENTS—Continued

### Check Operation of Automatic Height Control System

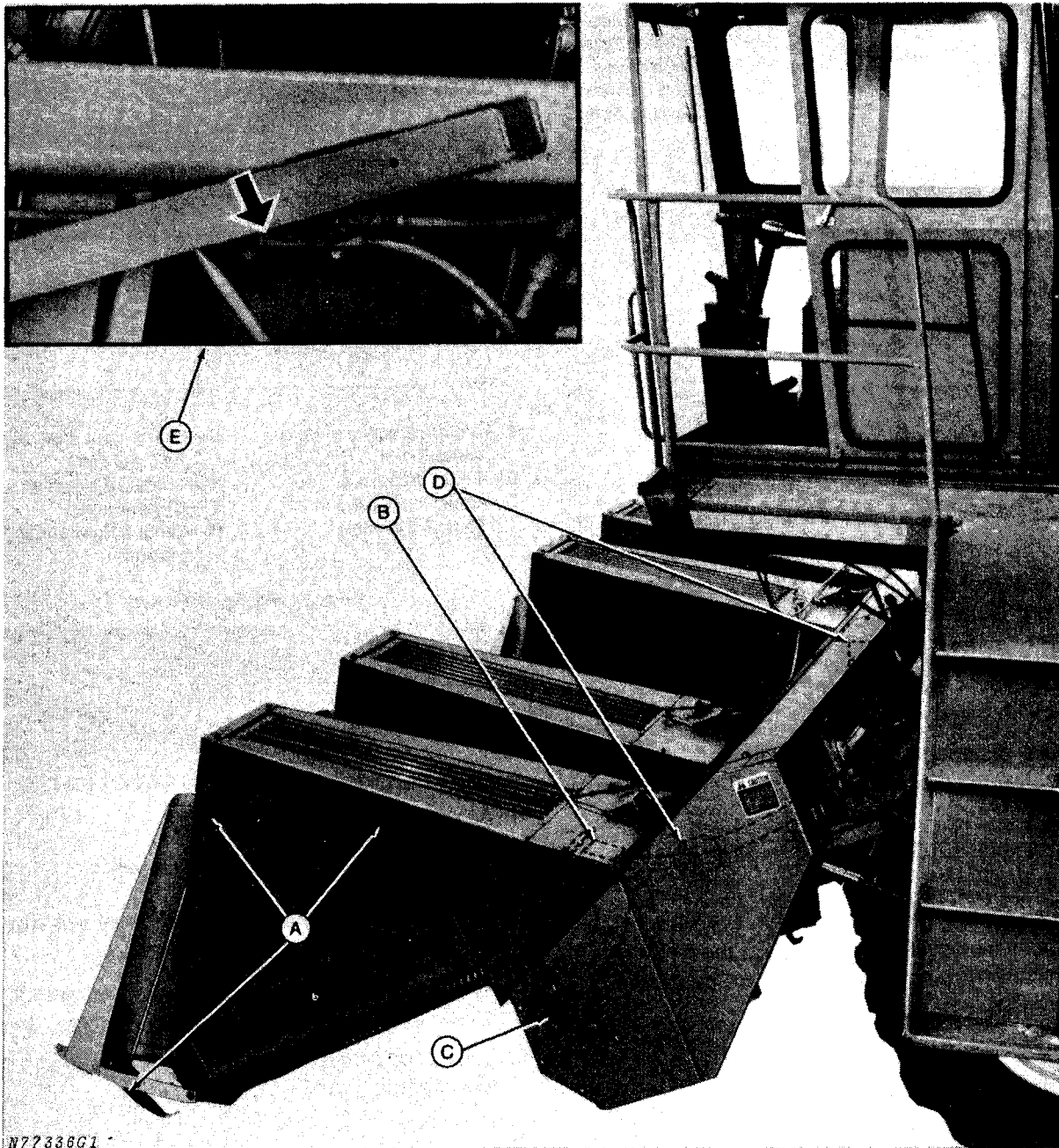

A—Shoe and Linkage  
 B—Height Control Valve

C—Height Control Cylinder  
 D—50-50 Flow Divider

E—31-69 Flow Divider  
 F—Height Adjusting Levers

Fig. 23-Automatic Height Control Schematic

The height control system components include the shoes and linkages (A, Fig. 23), valves (B), cylinders (C), 50-50 flow dividers (D), 31-69 flow divider (E), and height adjusting levers (F).

In addition, the hydraulic portion of the height control system employs the front section of the hydraulic pump and the reservoir. The rear section of the pump is used for the other stripper hydraulic functions.

*NOTE: Refer to Section 70, Group 5 "General Information" and "Tests" for flow diagrams of height control hydraulic functions.*



**Suggest:**

**If the above button click is invalid.**

**Please download this document**

**first, and then click the above link**

**to download the complete manual.**

**Thank you so much for reading**

### Checking Height Control System

**⚠ CAUTION:** Be sure row units are disengaged when working around the stripper.

**IMPORTANT:** Check hydraulic pump belt for proper tension. Check the hydraulic oil reservoir and add oil if needed. Start the engine and let hydraulic oil warm up to normal operating temperature (160°F. [70°C]). Check all linkages to make sure they are not binding and that all unit height control cylinders are aligned. (Shift units slightly one way or the other, if necessary, to achieve cylinder alignment.) Check drive wheel air pressures and adjust as needed. (See page 10-10-2).

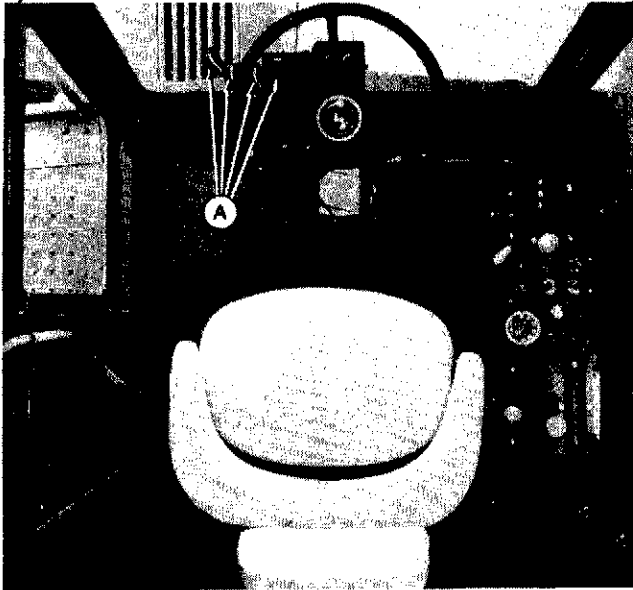

Fig. 23-Height Control Levers

1. With the engine running at 2500 rpm, raise and lower the rockshaft and each unit several times to purge air from the system.

2. Move rockshaft control lever and individual unit height control levers fully forward (A, Fig. 23) and check position of units. All units should be fully down (floor must be level).

3. Raise and lower the units with the individual control levers. They should respond quickly. With all levers pulled back, all units should be at the same height.

4. With height control levers at mid-range, have a second person manually raise a height sensing shoe until the unit is fully up. Release shoe, unit should return to original position.

**IMPORTANT:** If the system reacts as above, THE SYSTEM IS ADJUSTED PROPERLY — DO NOT READJUST.

If the system needs adjusting, refer to Section 70, Group 30.

**<https://www.ebooklibonline.com>**

Hello dear friend!

Thank you very much for reading.

Enter the link into your browser.

The full manual is available for immediate download.

**<https://www.ebooklibonline.com>**