

JOHN DEERE
WORLDWIDE COMMERCIAL & CONSUMER
EQUIPMENT DIVISION

Lawn and Garden Tractors
355D

OPERATOR'S MANUAL



 **WARNING:** The Engine Exhaust from this product contains chemicals known to the State of California to cause cancer, birth defects or other reproductive harm.

California Proposition 65 Warning

OMM141524 C0

North American Version
Litho in U.S.A.

INTRODUCTION

Thank You for Purchasing a John Deere Product

We appreciate your business and wish you many years of safe and satisfied use of your machine.

Using Your Operator's Manual

This manual is an important part of your machine and should remain with the machine when you sell it.

Reading your operator's manual will help you and others avoid personal injury or damage to the machine. Information given in this manual will provide the operator with the safest and most effective use of the machine. Knowing how to operate this machine safely and correctly will allow you to train others who may operate this machine.

Sections in your operator's manual are placed in a specific order to help you understand all the safety messages and learn the controls so you can operate this machine safely. You can also use this manual to answer any specific operating or servicing questions. A convenient index located at the end of this book will help you to find needed information quickly.

The machine shown in this manual may differ slightly from your machine, but will be similar enough to help you understand our instructions.

RIGHT-HAND and LEFT-HAND sides are determined by facing in the direction the machine will travel when going forward. When you see a broken line arrow (----->), the item referred to is hidden from view.

Special Messages

Your manual contains special messages to bring attention to potential safety concerns, machine damage as well as helpful operating and servicing information. Please read all the highlighted information carefully to avoid injury and machine damage.

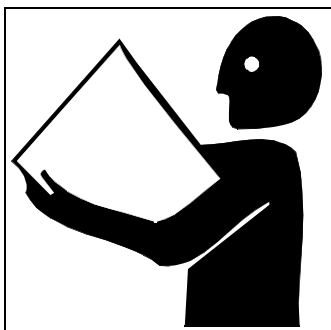

CAUTION: Avoid injury! This symbol and text highlight potential hazards or death to the operator or bystanders may occur if the hazards or procedures are ignored.

IMPORTANT: Avoid damage! This text is used to tell the operator of actions or conditions that might result in damage to the machine.

NOTE: *General information is given throughout the manual that may help the operator in the operation of the machine.*

PRODUCT IDENTIFICATION

Record Identification Numbers

Lawn and Garden Tractors

355D Serial No. (085001 -)

If you need to contact an Authorized Service Center for information on servicing, always provide the product model and serial number.

You will need to locate the model and serial number for the machine and for the engine of your machine and record the information in the spaces provided below.

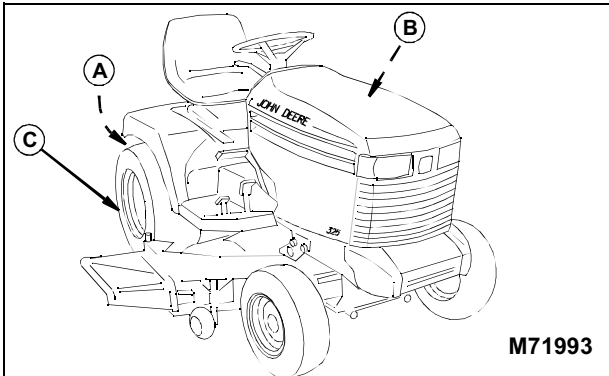

DATE OF PURCHASE:

DEALER NAME:

DEALER PHONE:

PRODUCT IDENTIFICATION NUMBER (A):

ENGINE SERIAL NUMBER (B):

<https://www.ebooklibonline.com>

Hello dear friend!

Thank you very much for reading.

Enter the link into your browser.

The full manual is available for immediate download.

<https://www.ebooklibonline.com>

TABLE OF CONTENTS

Safety	1
Operating	6
Replacement Parts	27
Service Intervals	28
Service Lubrication	29
Service Engine	31
Service Transmission.....	39
Service Mower	42
Service Electrical.....	51
Service Miscellaneous.....	55
Troubleshooting	60
Storage	63
Assembly	64
Specifications	68
Warranty	70
Index.....	73

All information, illustrations and specifications in this manual are based on the latest information at the time of publication. The right is reserved to make changes at any time without notice.

COPYRIGHT© 2000
Deere & Co.

John Deere Worldwide Commercial and
Consumer Equipment Division
Horicon, WI

All rights reserved
Previous Editions
COPYRIGHT© 1999 1998

OMM141524 C0 - English

SAFETY

Safety-Alert Symbol

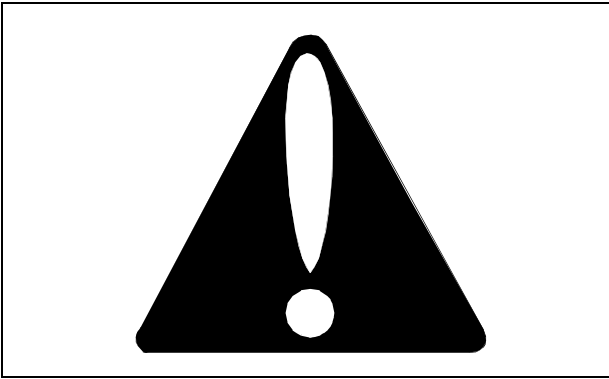

Read and recognize safety information. Be alert to the potential for personal injury when you see this safety-alert symbol.

On your machine safety labels, the words DANGER, WARNING, and CAUTION are used with this safety-alert symbol. DANGER identifies the most serious hazards. In this manual, the word CAUTION and this symbol call attention to safety messages.

WARNING - AVOID SERIOUS INJURY OR DEATH



- Drive up and down slopes, not across
- Avoid sudden turns
- If machine stops going uphill, stop blade and back down slowly
- Keep safety devices (guards, shields, and switches) in place and working
- Read operator's manual
- When leaving machine:
 - Stop engine
 - Set park brake
 - Remove key

DANGER - ROTATING BLADES CUT OFF ARMS AND LEGS



- Do not mow when children or others are around.
- Do not mow in reverse
- Look down and behind before and while backing
- Never carry children even with blades off

DANGER - BATTERY GASES AND ACID



SHIELD EYES EXPLOSIVE GASES can cause blindness or injury.

NO sparks, flames, or smoking.

SULFURIC ACID can cause blindness or severe burns.

CAUTION - FLUSH EYES IMMEDIATELY WITH WATER. GET MEDICAL HELP FAST. Keep out of reach of children. Do not tip. Keep caps tight and level.

SAFETY

DANGER - ROTATING BLADE



Do not put hands or feet under or into mower when engine is running

THROWN OBJECTS

Before mowing. Clear area of people and objects that may be thrown by blade

Do not operate mower without discharge chute or entire grass catcher in place.

DANGER - ROTATING BLADE

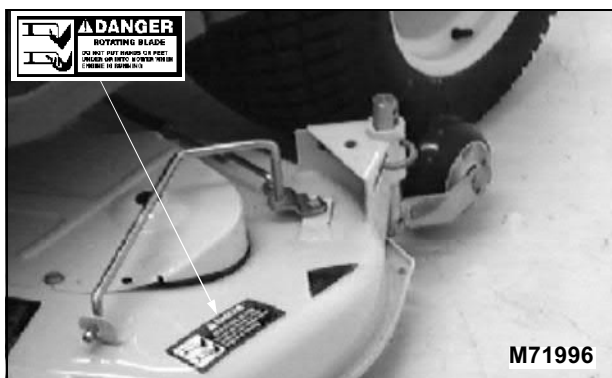

Do not put hands or feet under or into mower when engine is running

WARNING HOT SURFACE



Picture Note: Label is located on air filter cover.

Certification Label

This OPEI label on your mower indicates that this model has been certified by an independent laboratory for compliance with American National Standard B-71.1, "Safety Specifications" for Power Lawn Mowers, Lawn and Garden Tractors, and Lawn Tractors.

Operate Safely

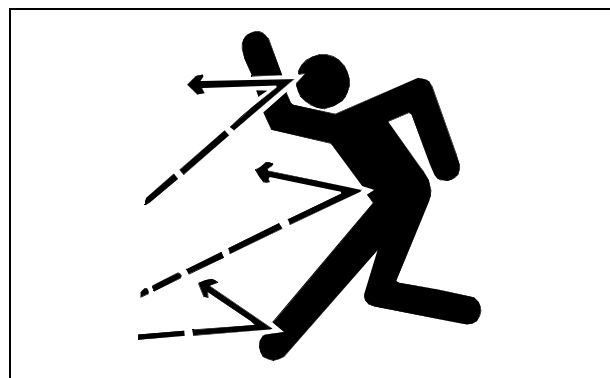

- Check brake action before you operate. Adjust or service brakes as necessary.
- Inspect machine before you operate. Be sure hardware is tight. Repair or replace damaged, badly worn, or missing parts. Be sure guards and shields are in good condition and fastened in place. Make any necessary adjustments before you operate.
- Clear work area of objects that might be thrown. Keep people and pets out of the work area. Stop machine if anyone enters the area.
- If you hit an object, stop the machine and inspect it. Make repairs before you operate. Keep machine and

SAFETY

attachments properly maintained and in good working order. Keep all shields and guards in place.

- DO NOT leave machine unattended when it is running.
- Only operate during daylight or with good artificial light.
- Be careful of traffic when operating near or crossing roadways.
- Do not wear radio or music headphones while operating the machine. Safe operation requires your full attention.
- Older adults are involved in a large percentage of riding mower accidents involving injury. These operators should evaluate their ability to operate a mower safely enough to protect the operator and others from serious injury.

Park Safely

- Stop machine on a level surface, not on a slope.
- Disengage PTO.
- Lower attachments to the ground.
- Engage park brake.
- STOP engine.
- Remove key.
- Before you leave the operator's seat, wait for engine and all moving parts to STOP.

Rotating Blades are Dangerous - Protect Children and Prevent Accidents

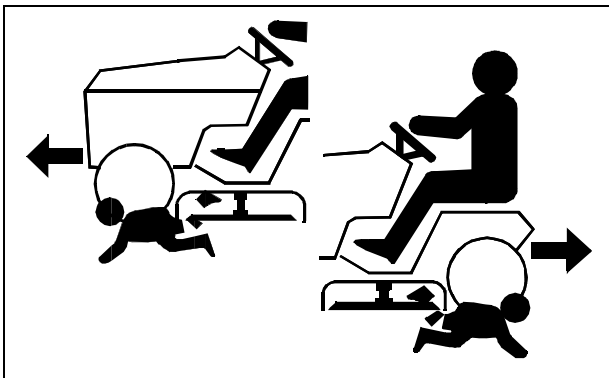

PROTECT CHILDREN:

- Never assume that children will remain where you last saw them. Children are attracted to mowing activity, stay alert to the presence of children.
- Keep children in the house when you are operating the machine.
- Turn machine off if a child enters the mowing area.

- Use extra care when you come to blind corners, shrubs, trees, or other objects that may block your vision.
- DO NOT let children or an untrained person operate the machine.
- DO NOT carry or let children ride on machine or any attachment even with blades off. DO NOT tow children in a cart or trailer.

HELP PREVENT SERIOUS OR FATAL ACCIDENTS:

- Be alert at all times, drive forward carefully. People especially children can move quickly into the mowing area before you know it.
- Back carefully. Shut off PTO and look behind the machine carefully, especially for children, before you back up.
- DO NOT mow in reverse unless it is absolutely necessary.
- Shut off PTO when you are not mowing.
- DO NOT operate machine if you are under the influence of drugs or alcohol.

Avoid Tipping

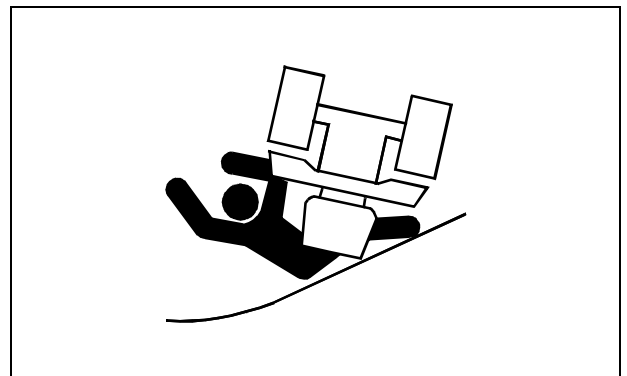

- DO NOT drive where machine could slip or tip.
- Stay alert for holes and other hidden hazards in the terrain.
- Keep away from drop-offs.
- Slow down before you make a sharp turn or operate on a slope.
- When pulling loads or using heavy equipment, use only approved hitches, limit loads to those you can safely control, and use counterweights or wheel weights when required per this manual or your attachment manual.
- Drive up and down a hill—not across. Be careful when you change direction on a slope.
- DO NOT stop when going up hill or down hill. If machine stops going up hill, STOP PTO and back down slowly.

SAFETY

- DO NOT mow wet grass. Reduced traction could cause sliding.
- DO NOT try to stabilize the machine by putting your foot on the ground.

Keep Riders Off



- Only allow the operator on the machine. Keep riders off.
- Riders on the machine or attachment may be struck by foreign objects or thrown off the machine causing serious injury.
- Riders obstruct the operator's view resulting in the machine being operated in an unsafe manner.

Check Wheel Bolts



- A serious accident could occur causing serious injury if wheel bolts are not tight.
- Check wheel bolt tightness often during the first 100 hours of operation.

Transport Safely

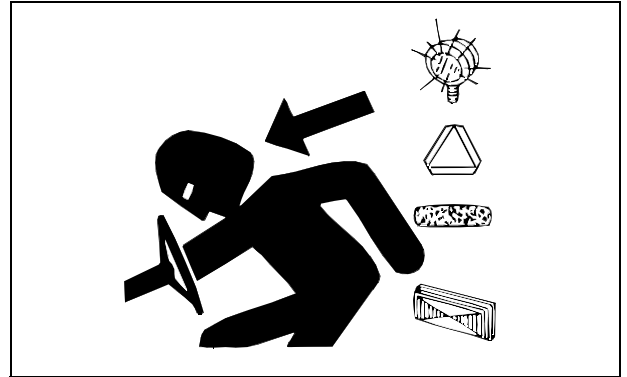

- Use safety lights and devices. Slow moving machines when driven on public roads are hard to see, especially at night. Avoid personal injury or death resulting from a collision with a vehicle.
- Whenever driving on public roads, use flashing warning lights and turn signals according to local regulations. Extra flashing warning lights may need to be installed.

Practice Safe Maintenance



- Understand service procedure before doing work. Keep area clean and dry.
- Never lubricate or service machine while it is moving. Keep safety devices in place and in working condition. Keep hardware tight.
- To prevent them from getting caught, keep hands, feet, clothing, jewelry, and long hair away from any moving parts.
- Before servicing machine, lower attachments to the ground. Disengage all power and stop the engine. Move hydraulic lift levers back and forth to relieve pressure. Lock park brake and remove the key. Let tractor cool.
- Securely support any machine elements that must be raised for service work.
- Never run engine unless park brake is locked.

SAFETY

- Keep all parts in good condition and properly installed. Fix damage immediately. Replace worn or broken parts. Remove any buildup of grease, oil, or debris.
- Disconnect battery ground cable (–) before making adjustments on electrical systems or welding on tractor.
- Unauthorized modifications to the tractor may impair its function and safety.

Wear Appropriate Clothing

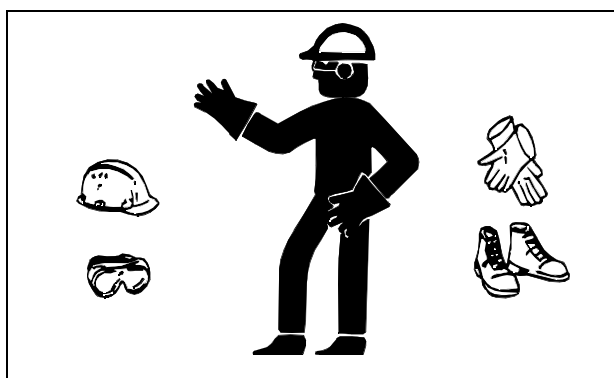

- Wear close fitting clothing and safety equipment appropriate for the job.
- Loud noise can cause impairment or loss of hearing, wear a suitable protective device such as earplugs.
- Do not wear radio or music headphones while servicing the machine. Safe service requires your full attention.

Handling Waste Product and Chemicals

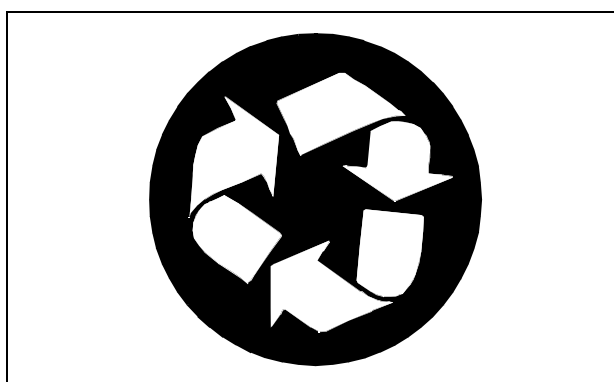

- Waste products, such as, used oil, fuel, coolant, brake fluid, and batteries, can harm the environment and people.
- DO NOT use beverage containers for waste fluids—someone may drink from them.
- See your local Recycling Center or John Deere dealer to learn how to recycle or get rid of waste products.

- A Material Safety Data Sheet (MSDS) provides specific details on chemical products: physical and health hazards, safety procedures, and emergency response techniques. See your John Deere dealer for the MSDS on chemical products used with your machine.

Avoid High Pressure Fluids



- Hydraulic hoses can fail due to physical damage, kinks, age, and exposure. Check hoses regularly. Replace damaged hoses.
- Escaping fluid under pressure can penetrate the skin causing serious injury. Avoid the hazard by relieving pressure before disconnecting hydraulic or other lines. Tighten all connections before applying pressure.
- Search for leaks with a piece of cardboard. Protect hands and body from high pressure fluids.
- If an accident occurs, see a doctor immediately. Any fluid injected into the skin must be surgically removed within a few hours or gangrene may result. Doctors unfamiliar with this type of injury should reference a knowledgeable medical source. Such information is available from Deere & Company Medical Department in Moline, Illinois, U.S.A.

OPERATING

Dash Controls

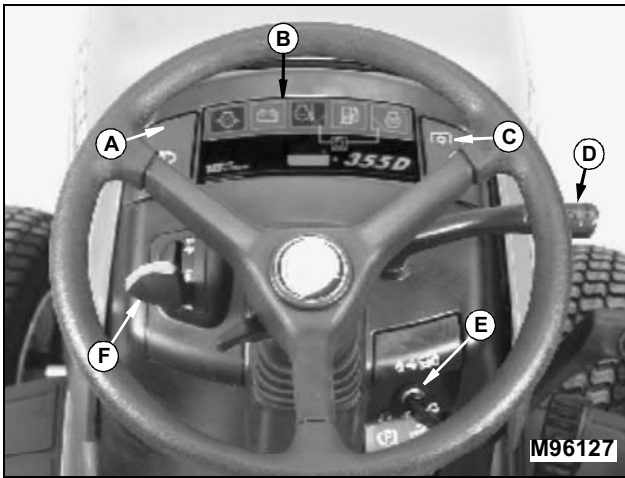

- A - Light Switch
- B - Indicator Lights
- C - PTO Switch / Reverse Implement Option
- D - Hydraulic Control Lever
- E - Key
- F - Throttle

Miscellaneous Controls

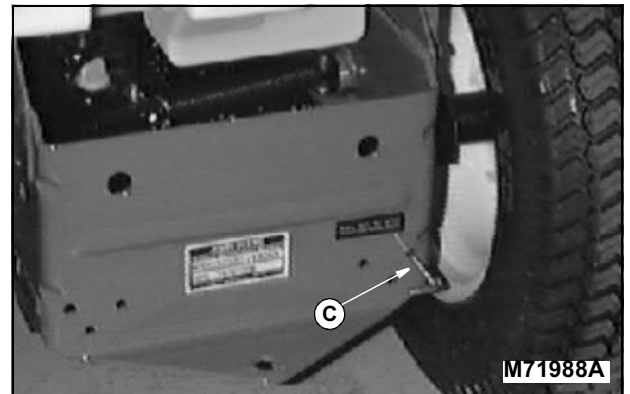
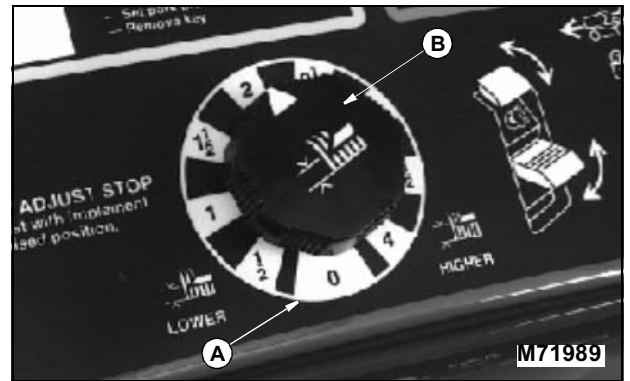

- A - Mower Height Indicator
- B - Mower Height Knob
- C - Free-Wheeling Lever

Foot/Platform Controls

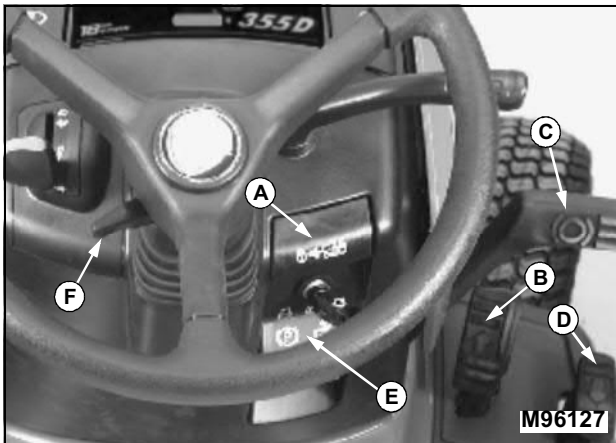

- A - Cruise Control Lever
- B - Forward Travel Pedal
- C - Brake Pedal
- D - Reverse Travel Pedal
- E - Park Brake Lever
- F - Tilt Steering Lever

Adjusting Tilt Steering Wheel



CAUTION: Avoid injury! To help avoid loss of steering control:

- Make sure steering wheel is **LOCKED** in position before operating machine.

Steering wheel has five tilt positions:

OPERATING



- Pull lever (A) down and push or pull wheel to a comfortable operating position.
- Push lever up to lock wheel in position.

Checking Fuel Level

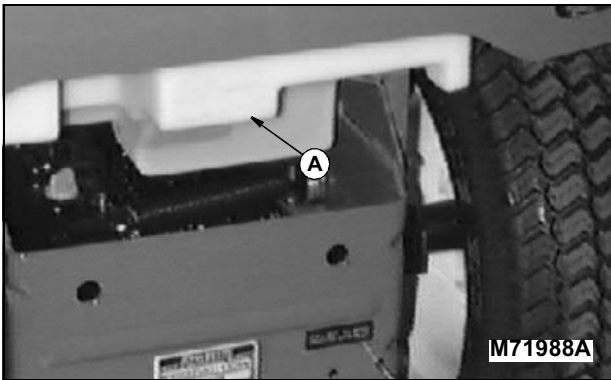

Amount of fuel is visible through fuel tank (A).

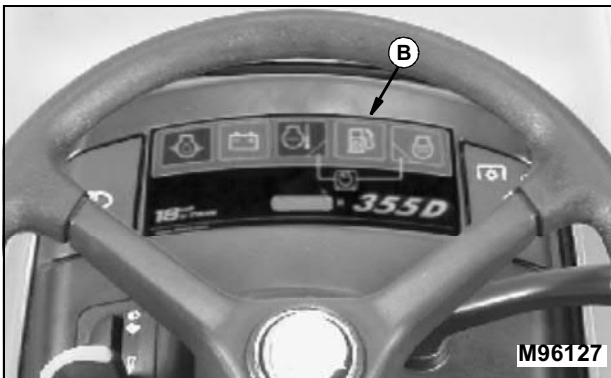

A low fuel light (B) on the dash will light up when fuel is getting low.

Adjusting Seat

Adjust Forward / Rearward

NOTE: This tractor is equipped with a fourteen position slide rail seat. Be sure seat is locked in position before operating.

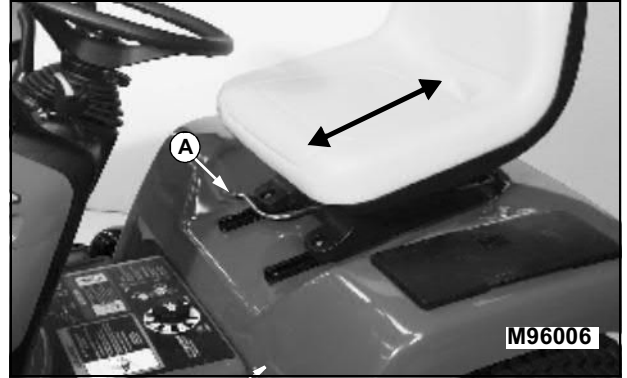

1. Push lever (A) to the left.
2. Slide seat forward or backward to desired position.
3. Release lever.

Adjust Seat Suspension

IMPORTANT: Avoid damage! To prevent damage to seat switch, seat base and fuel tank, **DO NOT** operate without suspension coils in place.

NOTE: Seat suspension can be adjusted to better match the weight of the operator.

1. Lift operators seat.

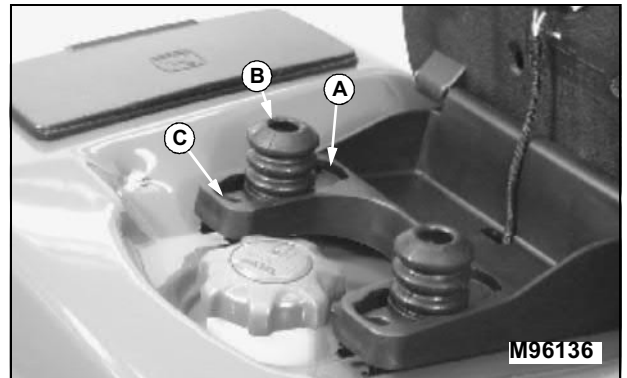

2. Suspension coils can be moved to three different settings:

- Soft Ride (A)
- Average Ride (B)
- Firm Ride (C)

Make sure suspension coils are in the same ride setting for



Suggest:

If the above button click is invalid.

Please download this document

first, and then click the above link

to download the complete manual.

Thank you so much for reading

OPERATING

each side.

Adjusting Rear Wheel Spacing

NOTE: Tractor is shipped from the factory with wheels in the narrow position.

- Turf Tires: Install wheel on with valve stem on the inside.
- Bar Tires: Install each wheel on opposite side of tractor. Bars on tires must point forward.

1. Park tractor on a level surface.
2. STOP engine.
3. LOCK park brake.



CAUTION: Avoid injury! Do not work under a raised tractor unless it is safely supported. A tractor that slips and falls off a jack could cause serious injury or death.

4. Put blocks in front and back of front wheels.

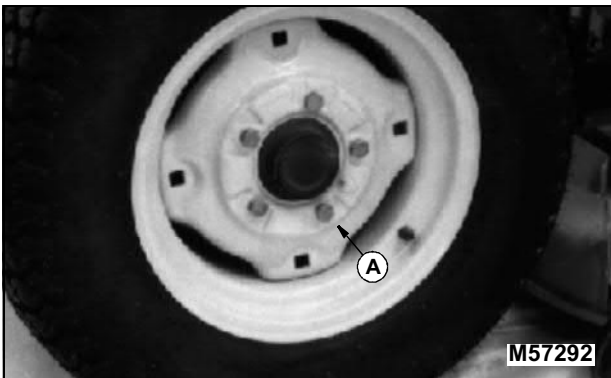

5. Loosen five rear wheel bolts (A). Lift rear wheels off the ground with floor jack or hoist.
6. Remove wheel bolts.
7. Install wheels in the wide position as follows:
8. Tighten wheel bolts to 88 N•m (65 lb-ft).
9. Lower rear wheels to the ground. Remove blocks from front wheels.

Tractors with 48C Mower Decks

NOTE: Due to rear tire and left rear gage wheel bracket interference, the rear wheels cannot be put into the wide position.

Tractors with 54 Mower Decks

NOTE: If rear tires are mounted in the wide position, move left hand rear gage wheel (B) from the inside of

gage wheel bracket (C) to the outside of gage wheel bracket. See line drawings below.

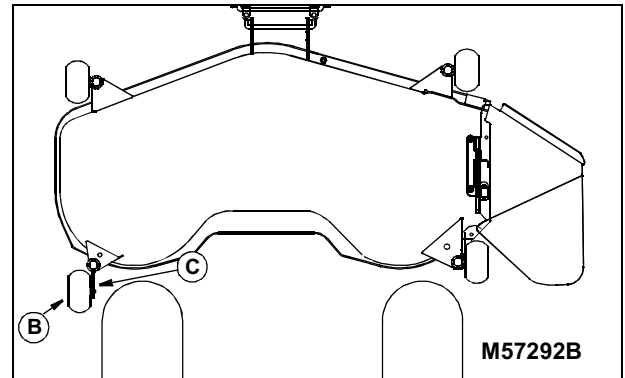

Picture Note: Tractor tires in the WIDE position.

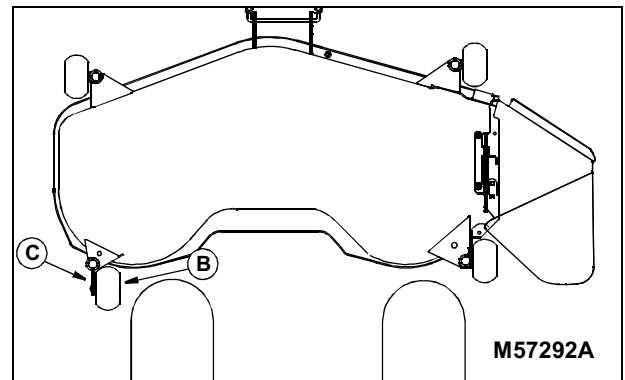

Picture Note: Tractor tires in the NARROW position.

Once this is done, the left rear gage wheel CANNOT be turned 90 degrees for deck removal. (The other three still can.)

Using the Park Brake



CAUTION: Avoid injury! The machine may begin to move when engine is shut off and park brake is not engaged. To avoid injury:

- always LOCK park brake before getting off tractor or leaving tractor unattended.

<https://www.ebooklibonline.com>

Hello dear friend!

Thank you very much for reading.

Enter the link into your browser.

The full manual is available for immediate download.

<https://www.ebooklibonline.com>