

JOHN DEERE
WORLDWIDE CONSTRUCTION
AND FORESTRY DIVISION

Skid Steer
240
250
OMKV18668 B3
OPERATOR'S MANUAL



JOHN DEERE

⚠ WARNING: Diesel engine exhaust and some of its constituents are known to the State of California to cause cancer, birth defects, and other reproductive harm.

California Proposition 65 Warning

North American Version
Litho in U.S.A.

INTRODUCTION

Thank You for Purchasing a John Deere Product

We appreciate having you as a customer and wish you many years of safe and satisfied use of your machine.

Using Your Operator's Manual

This manual is an important part of your machine and should remain with the machine at all times.

Reading your operator's manual will help you and others avoid personal injury or damage to the machine. Information given in this manual will provide the operator with the safest and most effective use of the machine. Knowing how to operate this machine safely and correctly will allow you to train others who may operate this machine.

This manual and safety signs on your machine may also be available in other languages (see your Authorized John Deere Skid Steer Dealer to order).

Sections in your operator's manual are placed in a specific order to help you understand all the safety messages and learn the controls so you can operate this machine safely. You can also use this manual to answer any specific operating or servicing questions. A convenient index located at the end of this book will help you to find needed information quickly.

The machine shown in this manual may differ slightly from your machine, but will be similar enough to help you understand our instructions.

RIGHT and LEFT sides are determined by facing in the direction the machine will travel when going forward. When you see a broken line arrow (----->), the item referred to is hidden from view.

Before delivering this machine, your dealer performed a predelivery inspection to ensure best performance.

Special Messages

Your manual contains special messages to bring attention to potential safety concerns, machine damage as well as helpful operating and servicing information. Please read all the information carefully to avoid injury and machine damage.

IMPORTANT: Avoid damage! This text is used to tell the operator of actions or conditions that might result in damage to the machine.

NOTE: Information is given throughout the manual that may help the operator with the operation or service of the machine.



CAUTION: Avoid injury! This symbol and text highlight potential hazards or death to the operator or bystanders that may occur if the hazards or procedures are ignored.

PRODUCT IDENTIFICATION

Record Identification Numbers

Skid Steers

240 PIN (440001 -)

250 PIN (450001 -)

If you need to contact an Authorized Service Center for information on servicing, always provide the product model and identification numbers.

You will need to locate the identification numbers for the product. Record the information in the spaces provided below.

DATE OF PURCHASE:

DEALER NAME:

DEALER PHONE:

PRODUCT IDENTIFICATION NUMBER (A):

ENGINE SERIAL NUMBER (B):

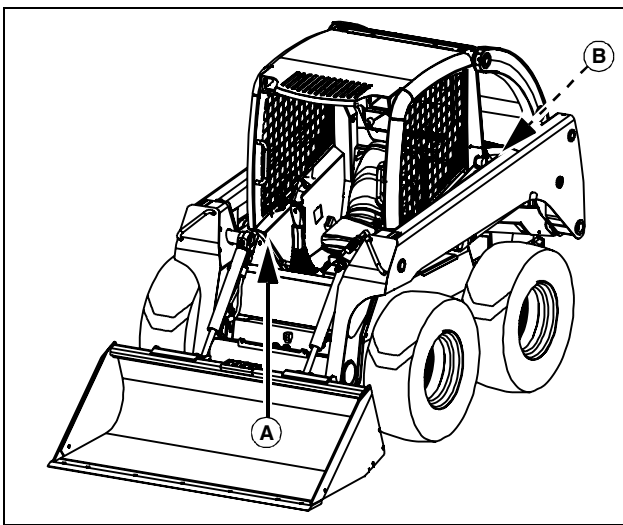

KV14257

<https://www.ebooklibonline.com>

Hello dear friend!

Thank you very much for reading.

Enter the link into your browser.

The full manual is available for immediate download.

<https://www.ebooklibonline.com>

TABLE OF CONTENTS

Safety	1
Operating	11
Replacement Parts.....	33
Service Intervals.....	34
Service Lubrication.....	35
Service Engine	36
Service Chain Case.....	44
Service Hydraulics.....	45
Service Steering & Brakes.....	47
Service Electrical.....	49
Service Miscellaneous.....	54
Troubleshooting	60
Storage	65
Specifications	66
Warranty	73
Index.....	76

All information, illustrations and specifications in this manual are based on the latest information at the time of publication. The right is reserved to make changes at any time without notice.

COPYRIGHT© 2003
DEERE & COMPANY
Moline, Illinois
All rights reserved
Previous Editions
COPYRIGHT©

OMKV18668 B3 - English

SAFETY

Understanding The Machine Safety Labels

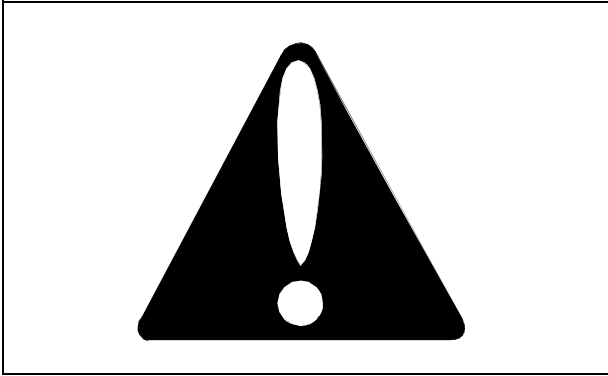

MIF

The machine safety labels shown in this section are placed in important areas on your machine to draw attention to potential safety hazards.

On your machine safety labels, the words DANGER, WARNING, and CAUTION are used with this safety-alert symbol. DANGER identifies the most serious hazards.

The operator's manual also explains any potential safety hazards whenever necessary in special safety messages that are identified with the word, CAUTION, and the safety-alert symbol.

CAUTION - Avoid Overturn

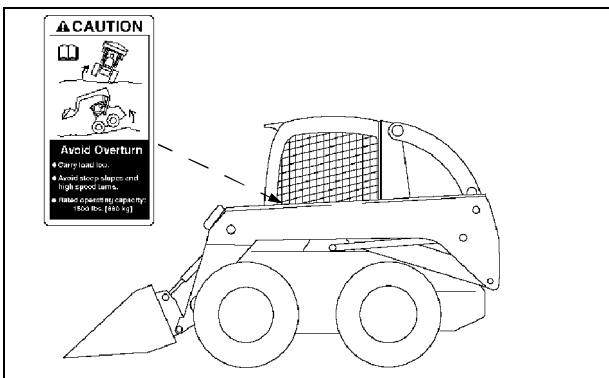

KV14256 T165343

- Carry Load Low
- Avoid Steep Slopes and High Speed Turns
- Rated Operating Capacity

DANGER - Avoid Death or Serious Injury

Before Removing Seat Belt and Leaving Seat:

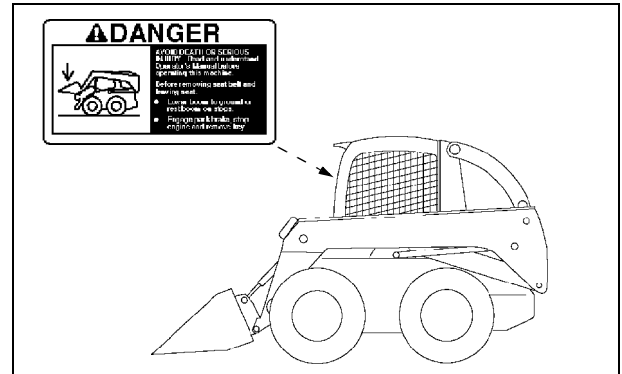

KV14256 T165350

- Lower Boom To Ground or Rest Boom on Stops
- Engage Park Brake, Stop Engine and Remove Key

CAUTION - Avoid Injury

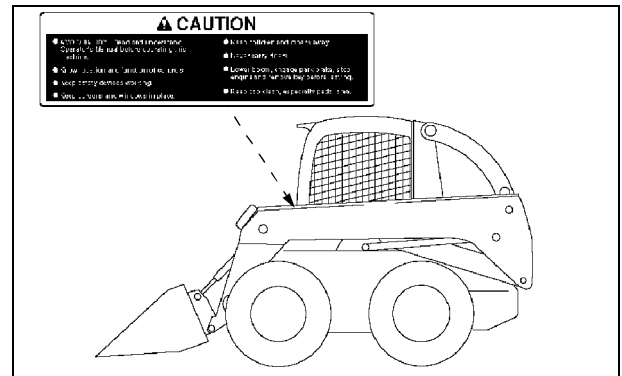

KV14256 T165351

- Read and Understand Operator's Manual Before Operating this Machine
- Know Location and Function of Controls
- Keep Safety Devices Working
- Keep Screens and Windows in Place
- Keep Children and Others Away
- Never Carry Riders
- Lower Boom, Engage Park Brake, Stop Engine and Remove Key Before Leaving
- Keep Cab Clean, Especially Pedal Area

SAFETY

WARNING - Avoid Injury

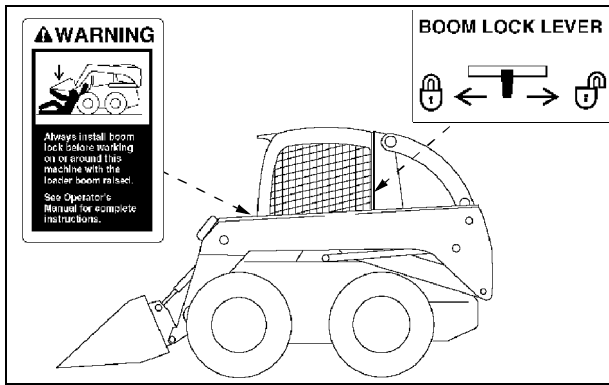

Always install boom lock before working on or around this machine with the loader boom raised.

See Operator's Manual for complete instructions.

WARNING - Avoid Injury

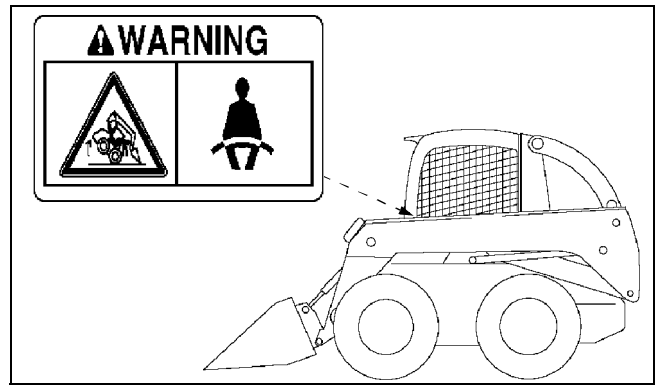

Always wear seat belt when operating skid steer.

Failure to wear seat belt could result in an injury from an accident such as an overturn.

WARNING - Emergency Cab Exit

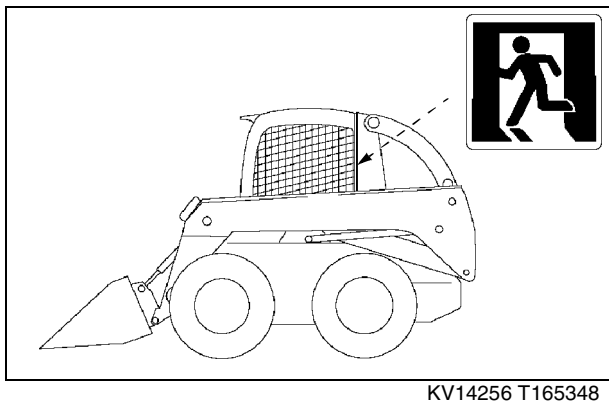

Remove the rear window to provide an exit in an emergency when the front exit is blocked.

CAUTION - Avoid Injury

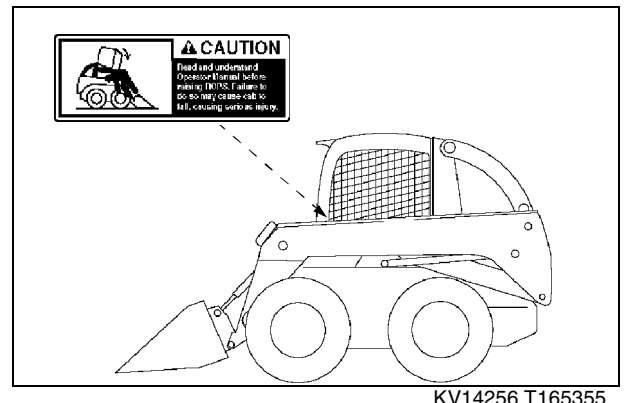

Read and Understand Operator Manual Before Raising ROPS. Failure to do so May Cause Cab to Fall Causing Serious Injury.

SAFETY

WARNING - Pinch Area

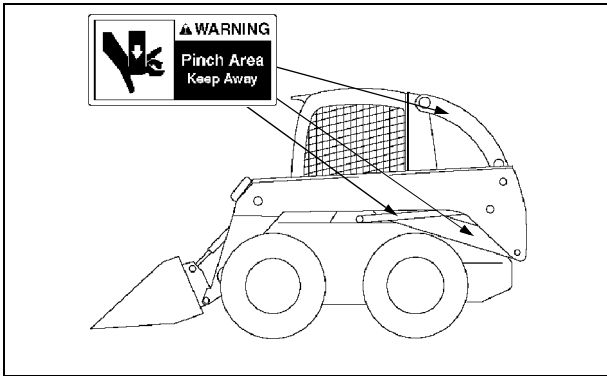

KV14256 T165344

Keep Away

IMPORTANT

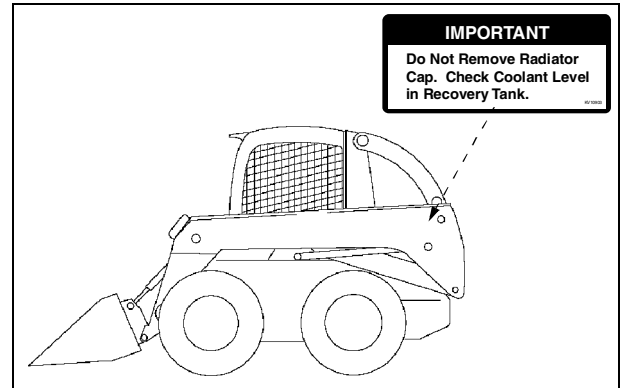

KV14256 KV10903

Do Not Remove Radiator Cap. Check Coolant Level in Recovery Tank.

WARNING - DANGER

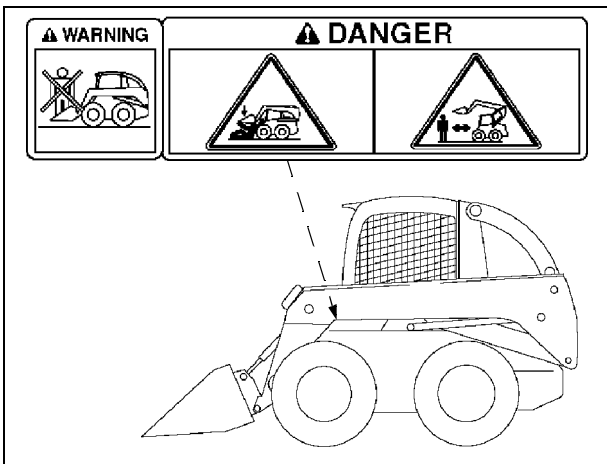

KV14256 T165356

- DO NOT allow riders in the bucket.
- Never stand or lean anywhere on skid steer or linkage will crush you.

WARNING

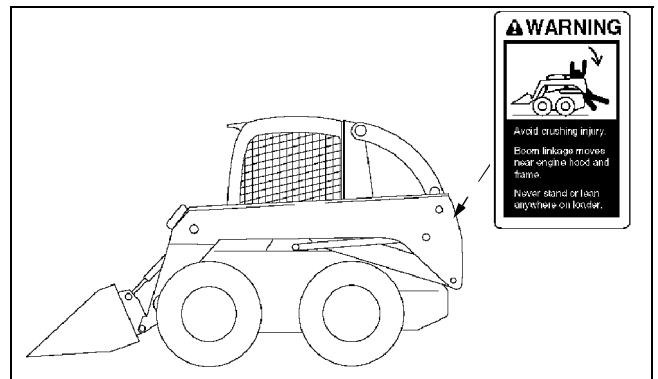

KV14256 T165347

- Boom Moves Near Engine Hood and Frame.
- Never Stand Or Lean Anywhere On Skid Steer Or Linkage Will Crush You.

SAFETY

CAUTION - Avoid an Explosion

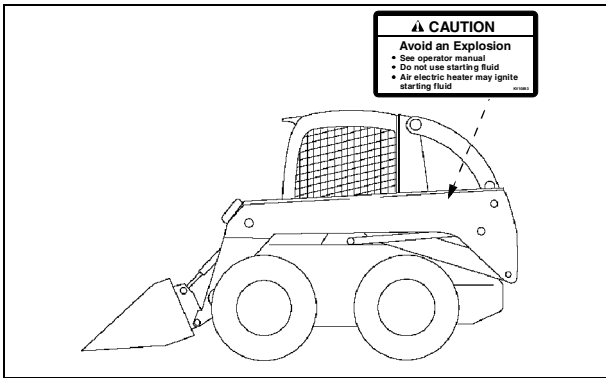

KV14256 KV10893

- See operator manual
- Do not use starting fluid
- Air electric heater may ignite starting fluid

WARNING - Avoid Rotating Fan

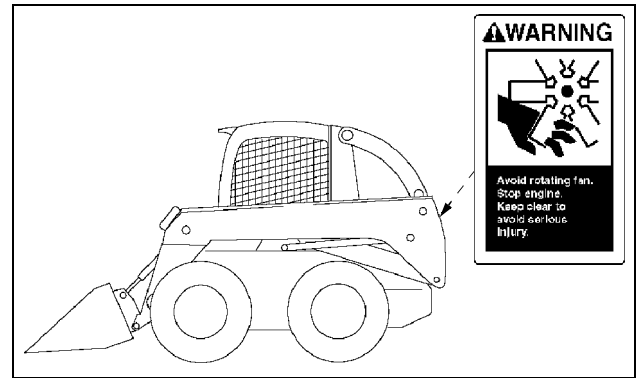

KV12456 T165346

Stop engine. Keep clear to avoid serious injury.

CAUTION - To Prevent Shock

WARNING

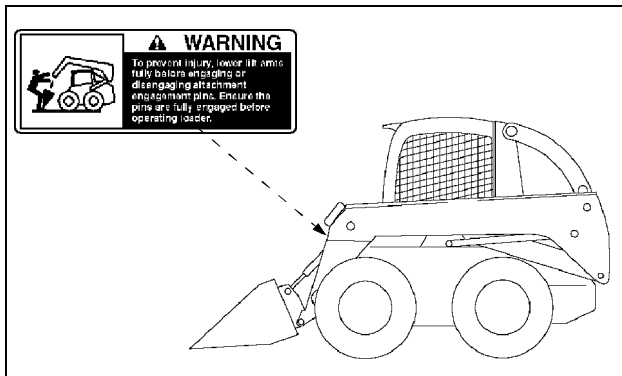

KV12456 T165357

To prevent injury, lower lift arms fully before engaging or disengaging attachment engagement pins. Ensure the pins are fully engaged before operating loader.

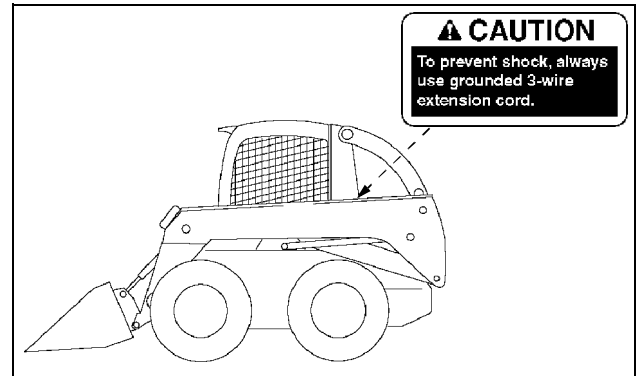

KV12456 T165345

Always use grounded 3-wire extension cord.

SAFETY

Operate Safely

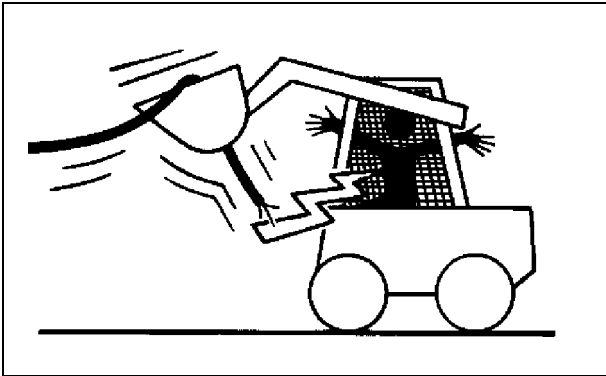

M62140

- Do not work under overhangs, electric wires, or where there is danger of a slide.
- Never use starting fluid to start engine. This machine has an electric air heater which can ignite starting fluid.
- Keep people and pets out of the worksite. Stop machine if anyone enters the worksite.
- If you hit an object, stop the machine and inspect machine for damage. Make repairs before you operate again. Keep machine and attachments properly maintained and in good working order. Keep all shields and guards in place. Keep screens and windows in place.
- Do not leave machine unattended while it is running.
- Operate only during daylight or with adequate artificial light.
- Be careful of traffic when operating near or crossing roadways.
- Do not reach out of operator's station. Boom is lowered and raised during operation and can cause injury.

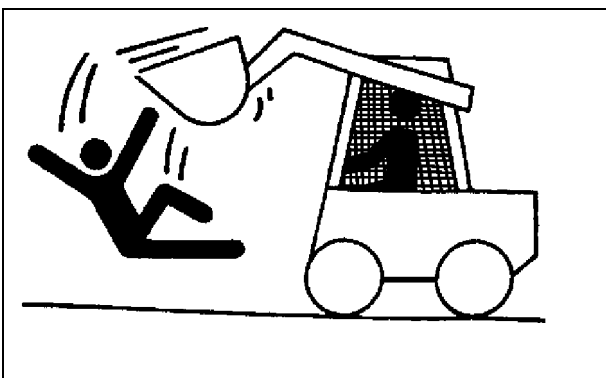

M61937

- Do not use a bucket or attachment as a work platform or for carrying people.
- Do not move loads over the heads of other people.
- Keep operator's station clean and clear of debris, especially area around pedals.

Protect Children and Prevent Accidents

Protect Children:

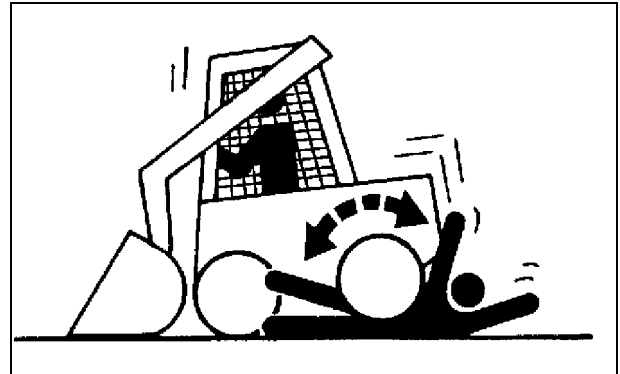

M61936

- Never assume that children will remain where you last saw them. Children are attracted to machine activity; stay alert to the presence of children.
- Turn machine off if a child enters the worksite.
- Use extra care when you come to blind corners, shrubs, trees, or other objects that may block your vision.
- Do not let children or an untrained person operate the machine.
- Do not carry or let children ride on machine or any attachment.

Help Prevent Serious Or Fatal Accidents:

- Be alert at all times; drive forward carefully. People, especially children, can move quickly onto the worksite unnoticed.
- An operator must continuously be aware of all co-workers who share the worksite.
- Backup carefully. An operator must always look to each side and to the rear for co-workers before backing up.

SAFETY

Keep Riders Off

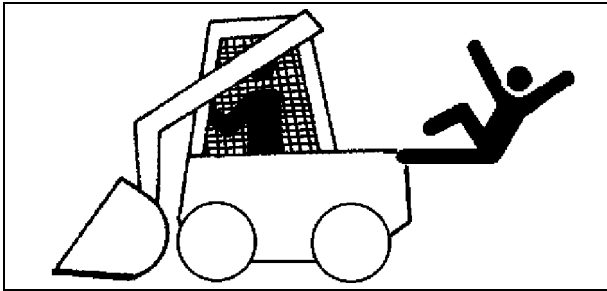

M61936A

- Allow only the operator on the machine. Keep riders off.
- Riders on the machine or attachment may be struck by foreign objects or thrown off the machine causing serious injury.
- Riders obstruct the operator's view resulting in the machine being operated in an unsafe manner.

Avoid Tipping



m57059A

- Do not drive where machine could slip or tip.
- Stay alert for holes and other hidden hazards in the terrain.
- Keep away from steep hillsides and drop-offs.
- Slow down before you make a sharp turn or operate on a slope.
- Limit loads to those you can safely control.
- Use counterweights when required per your attachment manual. Carry loads low.
- Drive up and down a hill - not across. Be careful when you change direction on a slope.
- Never drive up or back up a hill or incline with a raised boom.
- If the skid steer should start to tip forward and the boom is raised, immediately lower the boom to regain skid steer stability.

Park Safely

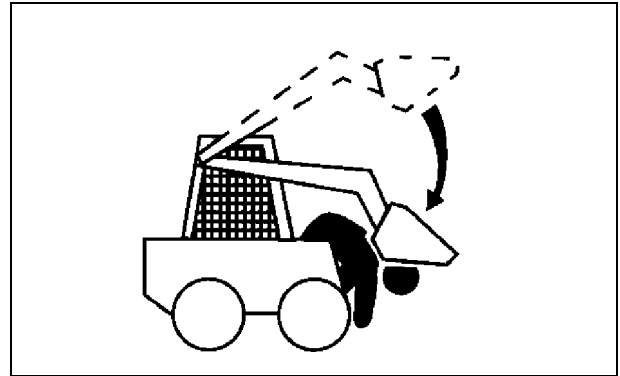

M57057A

Before removing seat belt and leaving seat:

1. Stop machine on a level surface, not on a slope.
2. Lower boom so attachments are on the ground. (If you must leave boom raised, be sure any attachment is removed and the boom locks are in the locked [Engaged] position, and boom is resting on locks.)
3. Engage park brake switch.
4. Stop engine.
5. Remove key.
6. Before you leave the operator's seat, wait for engine and all moving parts to stop.

Wear Appropriate Clothing

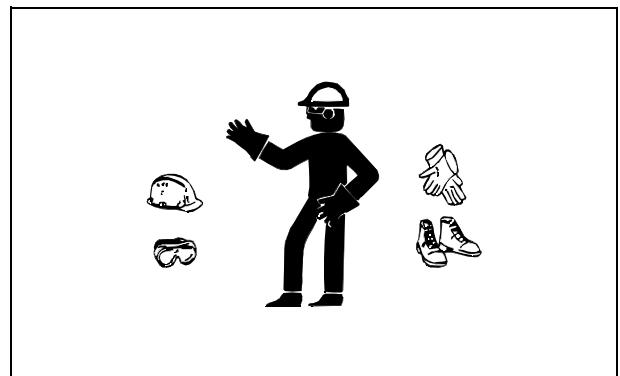

MIF

- Wear close fitting clothing and safety equipment appropriate for the job.
- Loud noise can cause impairment or loss of hearing, wear a suitable protective device such as earplugs.
- Do not wear radio or music headphones while operating the machine. Safe operation requires your full attention.

SAFETY

Check Lug Nuts



M71898WH

- A serious accident could occur causing serious injury if lug nuts are not tight.
- Check lug nut tightness often during the first 100 hours of operation. Tighten bolts to 237 N•m (175 lb-ft).

Transport Safely

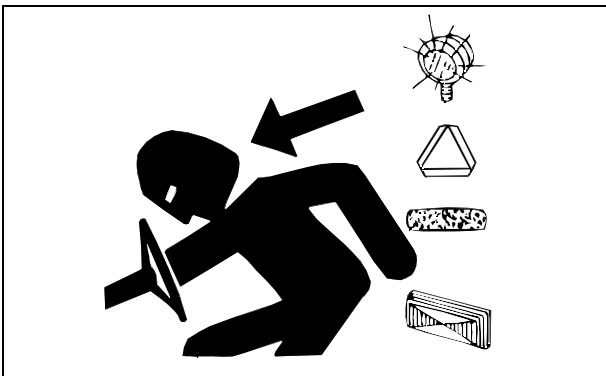

MIF

- Avoid personal injury or death resulting from a collision. Use safety lights and devices. Slow moving machines when driven on public roads are hard to see, especially at night.
- Whenever driving on public roads, use flashing warning lights according to local regulations. Additional lights may need to be installed. Machine should also be equipped with a SMV (Slow Moving Vehicle) sign.
- A SMV (Slow Moving Vehicle) sign is available from your Authorized John Deere Skid Steer Dealer.
- A dual flasher kit (four way flasher kit) is available from your Authorized John Deere Skid Steer Dealer.

Practice Safe Maintenance

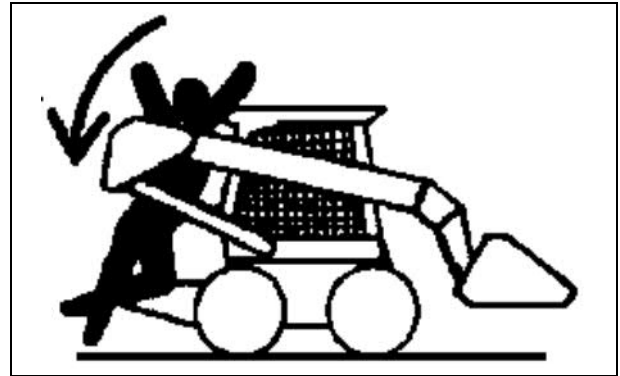

M71840A

- Do not work under a raised boom unless it is resting on boom locks. Lift arms move near engine hood and frame; never stand or lean on skid steer where linkage can crush you.
- Understand service procedure before doing work. Keep area clean and dry.
- Never lubricate or service machine while it is running. Keep safety devices in place and in working condition.
- Keep hardware tight.
- To prevent them from getting caught, keep hands, feet, clothing, jewelry, and long hair away from any moving parts.
- Before servicing machine, lower boom and attachment to the ground. Disengage all power. Engage park brake switch. Stop engine. With the seat belt fastened, turn the key switch to the run position (do not start the engine). Disengage the park brake switch. For hand/foot operated skid steers, move boom and bucket pedals back and forth to relieve hydraulic pressure. For hands only operated skid steers, move the boom and bucket control handles back and forth to relieve hydraulic pressure. Engage park brake switch. Remove the key. Let machine cool.
- Securely support any machine elements that must be raised for service work with safety jack stands or blocks.
- Never run engine unless park brake switch is engaged.
- Keep all parts in good condition and properly installed. Fix damage immediately. Replace worn or broken parts. Remove any buildup of grease, oil, or debris.
- Disconnect battery ground cable (-) before making adjustments on electrical systems or welding on machine.
- Unauthorized modifications to the machine may impair its function and safety.

SAFETY

Handling Waste Product and Chemicals

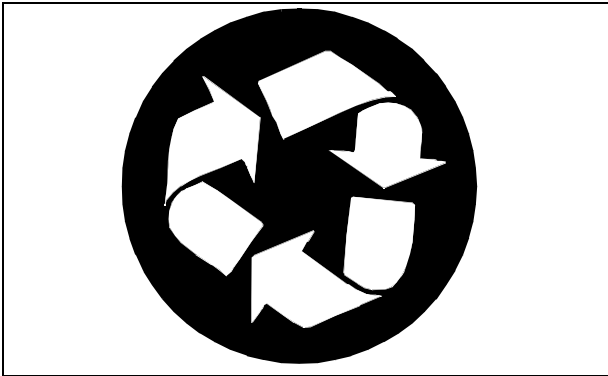

MIF

Waste products, such as, used oil, fuel, coolant, brake fluid, and batteries, can harm the environment and people:

- Do not use beverage containers for waste fluids - someone may drink from them.
- See your local Recycling Center or John Deere dealer to learn how to recycle or get rid of waste products.
- A Material Safety Data Sheet (MSDS) provides specific details on chemical products: physical and health hazards, safety procedures, and emergency response techniques. The seller of the chemical products used with your machine is responsible for providing the MSDS for that product.

Service Cooling System Safely

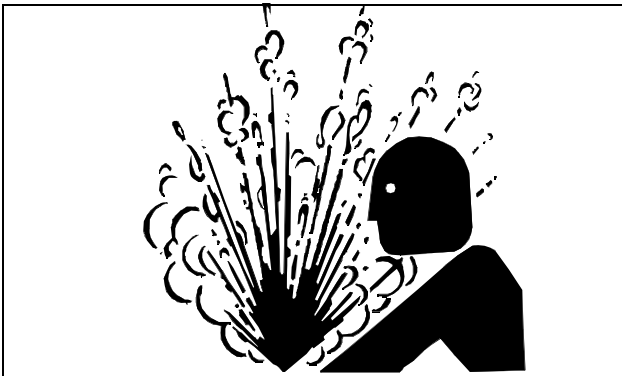

MIF

Explosive release of fluids from pressurized cooling systems can cause serious burns:

- Always shut off engine before checking cooling system.
- Remove cooling system filler cap only when the radiator is cool enough to touch with bare hands. Slowly loosen cap to first stop to relieve pressure before removing completely.

Avoid High Pressure Fluids



MIF

- Hydraulic hoses and lines can fail due to physical damage, kinks, age, and exposure. Check hoses and lines regularly. Replace damaged hoses and lines.
- Hydraulic fluid connections can loosen due to physical damage and vibration. Check connections regularly. Tighten loose connections.
- Escaping fluid under pressure can penetrate the skin causing serious injury. Avoid the hazard by relieving pressure before disconnecting hydraulic or other lines. Tighten all connections before applying pressure.
- Search for leaks with a piece of cardboard. Protect hands and body from high pressure fluids.
- If an accident occurs, see a doctor immediately. Any fluid injected into the skin must be surgically removed within a few hours or gangrene may result. Doctors unfamiliar with this type of injury should reference a knowledgeable medical source. Such information is available from Deere & Company Medical Department in Moline, Illinois, U.S.A. Information may be obtained in the United States and Canada only by calling 1-800-822-8262.



Suggest:

If the above button click is invalid.

Please download this document

first, and then click the above link

to download the complete manual.

Thank you so much for reading

SAFETY

Tire Safety

Explosive separation of a tire and rim parts can cause serious injury or death:



MIF

- Do not attempt to mount a tire without the proper equipment and experience to perform the job.
- Always maintain the correct tire pressure. Do not inflate the tires above the recommended pressure. Never weld or heat a wheel and tire assembly. The heat can cause an increase in air pressure resulting in a tire explosion. Welding can structurally weaken or deform the wheel.
- When inflating tires, use a clip-on chuck and extension hose long enough to allow you to stand to one side and not in front of or over the tire assembly.
- Check tires for low pressure, cuts, bubbles, damaged rims or missing lug bolts and nuts.

<https://www.ebooklibonline.com>

Hello dear friend!

Thank you very much for reading.

Enter the link into your browser.

The full manual is available for immediate download.

<https://www.ebooklibonline.com>