

**JOHN DEERE**  
**WORLDWIDE COMMERCIAL & CONSUMER**  
**EQUIPMENT DIVISION**

---

**Tractor Loader Backhoe**  
**110**

SN (710000- )

OMLVU19603 A9

**OPERATOR'S MANUAL**



**JOHN DEERE**

**⚠ WARNING:** Diesel engine exhaust and some of its constituents are known to the State of California to cause cancer, birth defects, and other reproductive harm.

California Proposition 65 Warning

North American Version  
Litho in U.S.A.

---

# INTRODUCTION

---

## Thank You for Purchasing a John Deere Product

We appreciate having you as a customer and wish you many years of safe and satisfied use of your machine.

## Using Your Operator's Manual

This manual is an important part of your machine and should remain with the machine when you sell it.

Reading your operator's manual will help you and others avoid personal injury or damage to the machine. Information given in this manual will provide the operator with the safest and most effective use of the machine. Knowing how to operate this machine safely and correctly will allow you to train others who may operate this machine.

If you have an attachment, use the safety and operating information in the attachment operator's manual along with the machine operator's manual to operate the attachment safely and correctly.

This manual and safety signs on your machine may also be available in other languages (see your authorized dealer to order).

**An online operational video** is available for your machine through the Internet. To view this video, go to [www.JohnDeere.com/OperationalVideos](http://www.JohnDeere.com/OperationalVideos) and click on the link for your machine model.

Sections in your operator's manual are placed in a specific order to help you understand all the safety messages and learn the controls so you can operate this machine safely. You can also use this manual to answer any specific operating or servicing questions. A convenient index located at the end of this book will help you to find needed information quickly.

The machine shown in this manual may differ slightly from your machine, but will be similar enough to help you understand our instructions.

RIGHT-HAND and LEFT-HAND sides are determined by facing in the direction the machine will travel when going forward. When you see a broken line (-----), the item referred to is hidden from view.

Before delivering this machine, your dealer performed a predelivery inspection to ensure best performance.

## Special Messages

Your manual contains special messages to bring attention to potential safety concerns, machine damage as well as helpful operating and servicing information. Please read all the information carefully to avoid injury and machine

damage.



**CAUTION: Avoid injury! This symbol and text highlight potential hazards or death to the operator or bystanders that may occur if the hazards or procedures are ignored.**

**IMPORTANT: Avoid damage! This text is used to tell the operator of actions or conditions that might result in damage to the machine.**

**NOTE: General information is given throughout the manual that may help the operator in the operation or service of the machine.**

## Attachments for Your Machine

There's a John Deere attachment or kit to make your new machine perform more tasks or be more versatile, whether your machine is a lawn tractor or compact utility tractor or a utility vehicle.

You can check out the entire line of attachments for your machine at [JohnDeere.com](http://JohnDeere.com) or ask your John Deere dealer. From aerators to electric lift kits to tillers, there's a John Deere attachment or kit to fill every need.

# PRODUCT IDENTIFICATION

## Record Identification Numbers

### Tractor Loader Backhoe

#### 110 PIN (710000 - )

If you need to contact an Authorized Service Center for information on servicing, always provide the product model and identification numbers.

You will need to locate the identifications numbers for the product. Record the information in the spaces provided below.

DATE OF PURCHASE:

\_\_\_\_\_

DEALER NAME:

\_\_\_\_\_

DEALER PHONE:

\_\_\_\_\_

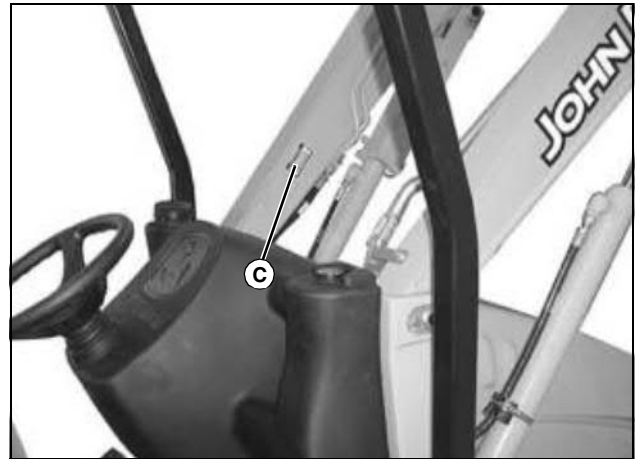

MX20615

LOADER IDENTIFICATION NUMBER (C):

-----

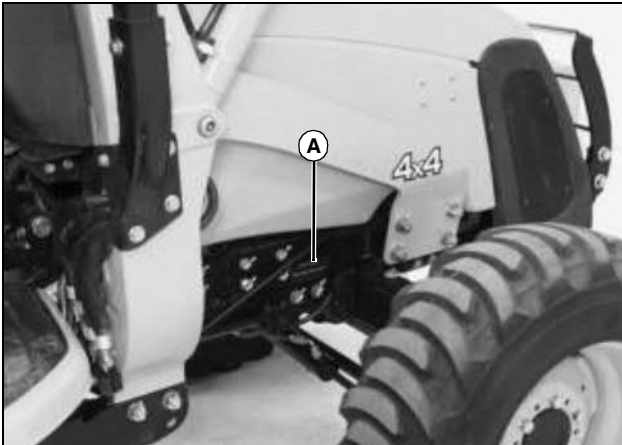

MX13750

PRODUCT IDENTIFICATION NUMBER (A):

-----



MX13752

BACKHOE IDENTIFICATION NUMBER (D):

-----

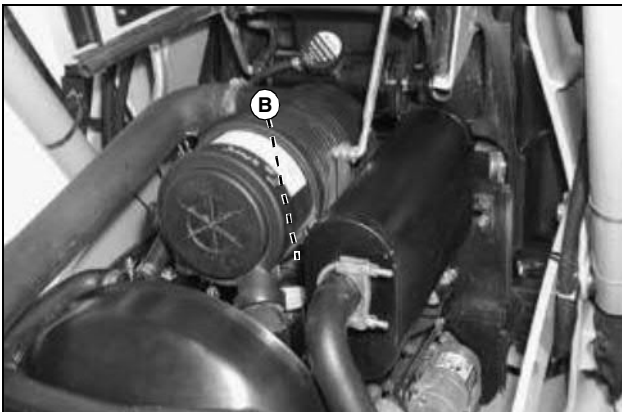

MX20600

ENGINE SERIAL NUMBER (B):

-----

**<https://www.ebooklibonline.com>**

Hello dear friend!

Thank you very much for reading.

Enter the link into your browser.

The full manual is available for immediate download.

**<https://www.ebooklibonline.com>**

# TABLE OF CONTENTS

---

Safety Labels .....	1
Safety .....	8
Operating - Controls .....	14
Operating - Machine .....	16
Operating - Backhoe .....	48
Replacement Parts .....	58
Service Intervals .....	59
Service Lubrication .....	61
Service Engine .....	64
Service Transmission .....	76
Service Electrical .....	80
Service Miscellaneous .....	85
Troubleshooting .....	91
Storage .....	100
Specifications .....	102
Warranty .....	110
Index .....	113

All information, illustrations and specifications in this manual are based on the latest information at the time of publication. The right is reserved to make changes at any time without notice.

COPYRIGHT© 2009  
Deere & Co.  
John Deere Worldwide Commercial and  
Consumer Equipment Division  
All rights reserved  
Previous Editions  
COPYRIGHT© 2007

OMLVU19603 A9 - English

# SAFETY LABELS

## Safety Label Location

Front View

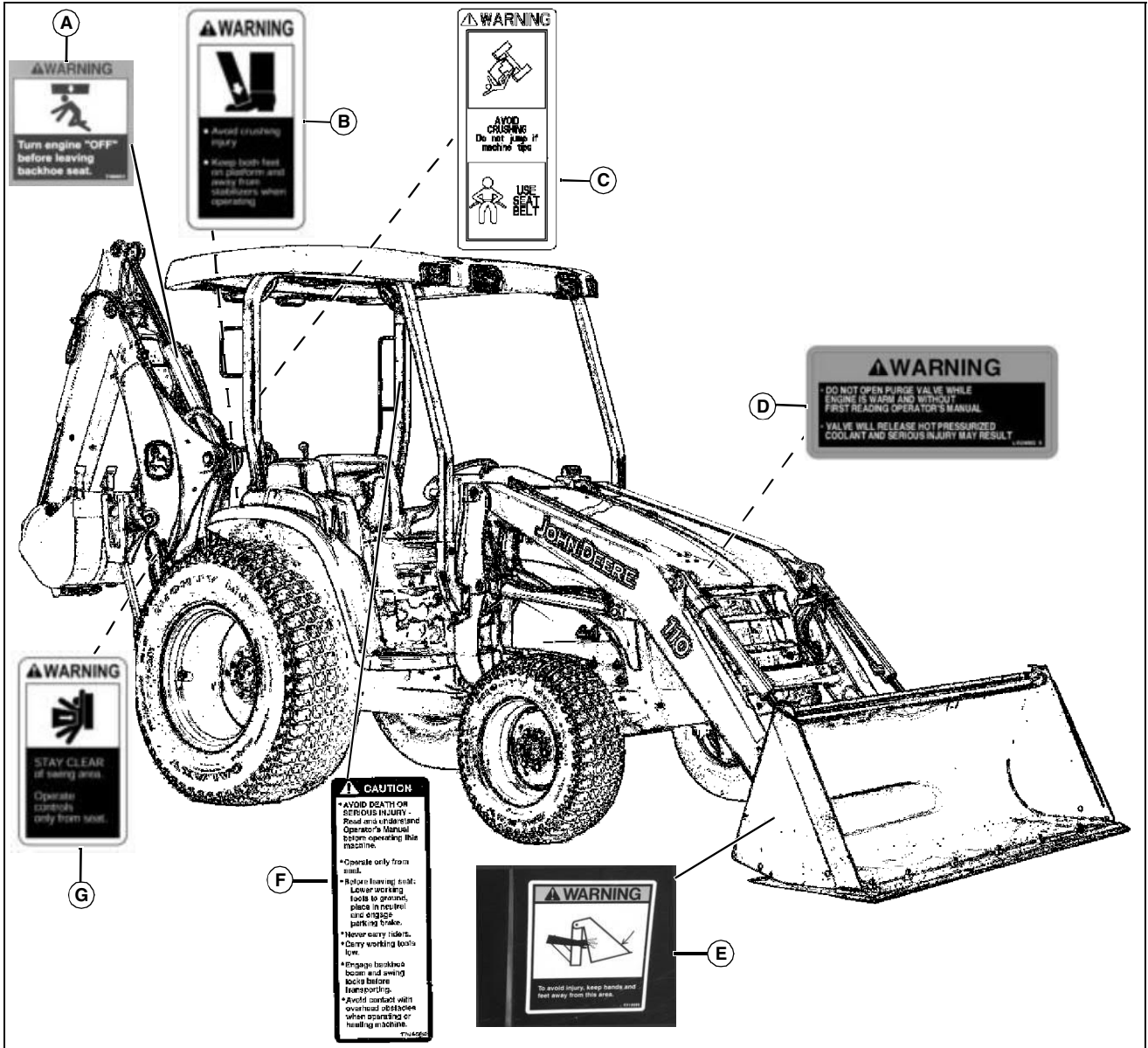

MX42080

**Picture Note:** Use label number listed in table below to locate complete text of safety label message following this illustration.

- A - WARNING T190902
- B - WARNING T188358
- C - WARNING LVU10707
- D - WARNING LVU16682
- E - WARNING KV15055
- F - CAUTION T146080
- G - WARNING T188815

# SAFETY LABELS

## Safety Label Location

## Rear View

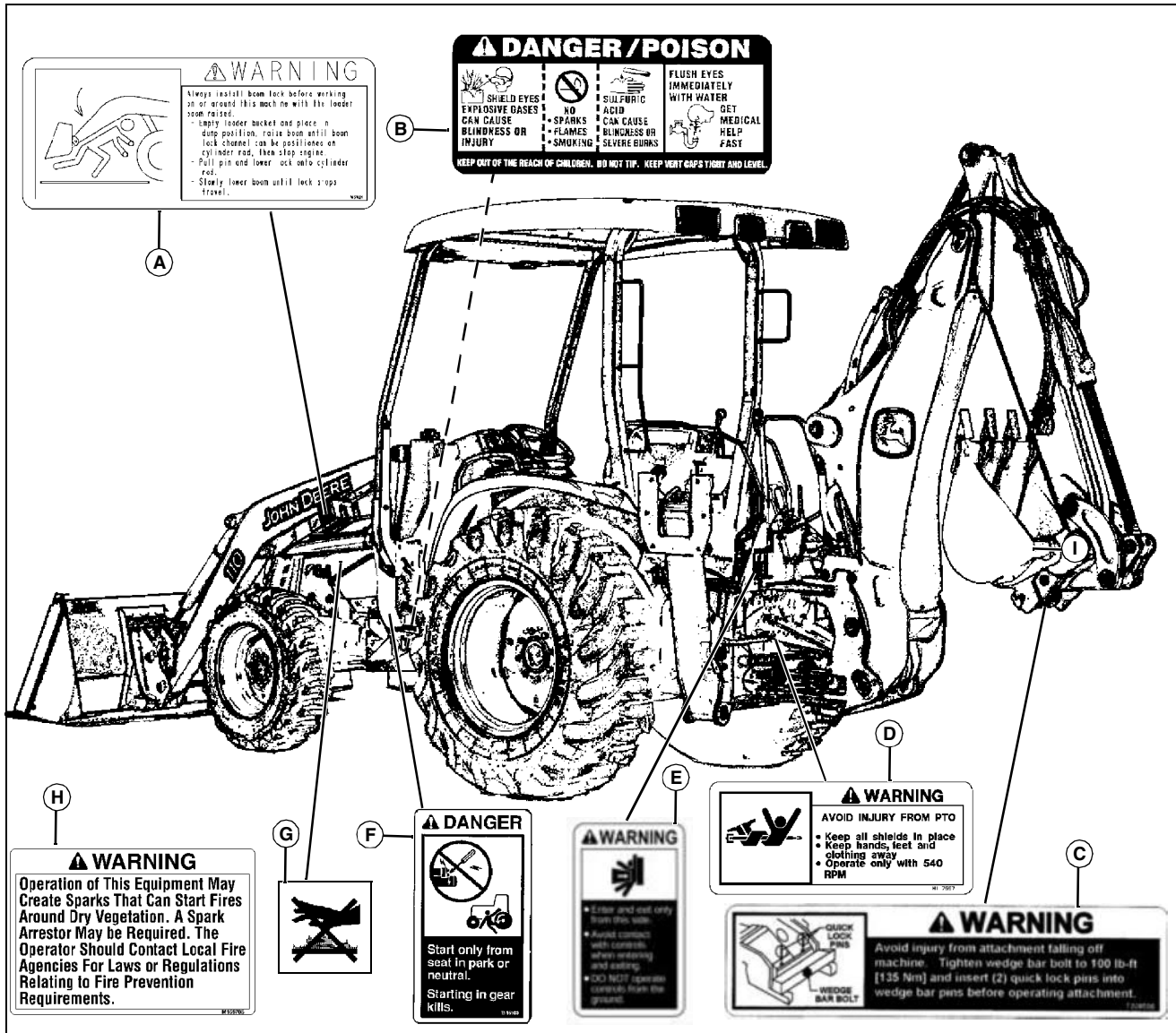

MX42086

**Picture Note:** Use label number listed in table below to locate complete text of safety label message following this illustration.

- A - WARNING W51421**
- B - DANGER/POISON (on battery)**
- C - WARNING T208596**
- D - WARNING M117557**
- E - WARNING T188814**
- F - DANGER T146103**
- G - CAUTION HOT SURFACE (embossed on muffler)**
- H - WARNING M159705**



## Understanding The Machine Safety Labels

The machine safety labels shown in this section are placed in important areas on your machine to draw attention to potential safety hazards.

On your machine safety labels, the words DANGER, WARNING, and CAUTION are used with this safety-alert symbol. DANGER identifies the most serious hazards.

The operator's manual also explains any potential safety hazards whenever necessary in special safety messages that are identified with the word, CAUTION, and the safety-alert symbol.

# SAFETY LABELS

## WARNING T208596

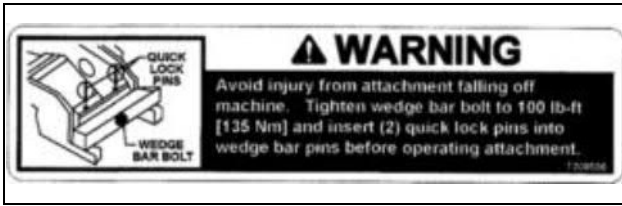

T208596

Avoid injury from attachment falling off machine. Tighten wedge bar bolt to 100 lb-ft [135 Nm] and insert (2) quick lock pins into wedge bar pins before operating attachment.

## WARNING T188358



T188358

- Avoid crushing injury.
- Keep both feet on platform and away from stabilizers when operating.

## WARNING T190902



T190902

Turn engine "OFF" before leaving backhoe seat.

## WARNING T188814



T188814

- Enter and exit only from this side.
- Avoid contact with controls when entering and exiting.
- DO NOT operate controls from the ground.

## WARNING M117557



M117557

### AVOID INJURY FROM PTO.

- Keep all shields in place.
- Keep hands, feet and clothing away.
- Operate only with 540 RPM.

# SAFETY LABELS

## DANGER/POISON

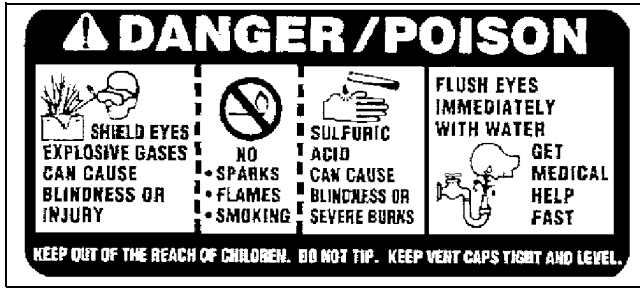

M88249

**KEEP OUT OF REACH OF CHILDREN. DO NOT TIP. KEEP VENT CAPS TIGHT AND LEVEL.**

- SHIELD EYES. EXPLOSIVE GASES CAN CAUSE BLINDNESS OR INJURY.
- NO SPARKS, FLAMES, SMOKING.
- SULFURIC ACID CAN CAUSE BLINDNESS OR SEVERE BURNS.
- FLUSH EYES IMMEDIATELY WITH WATER. GET MEDICAL HELP FAST.

## DANGER T146103



T146103

Start only from seat in park or neutral.  
Starting in gear kills.

## WARNING W51421

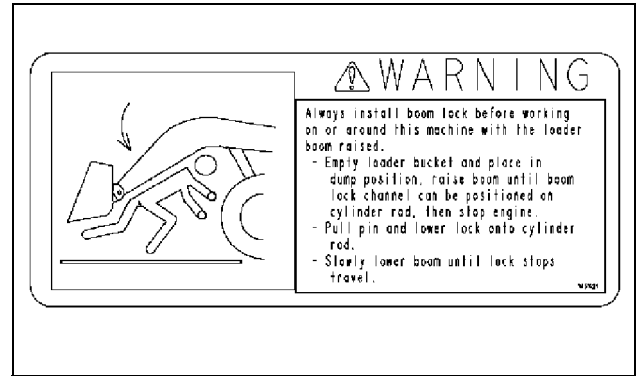

W51421

**Always install boom lock before working on or around this machine with the loader boom raised.**

- Empty loader bucket and place in dump position, raise boom until boom lock channel can be positioned on cylinder rod, then stop engine.
- Pull pin and lower lock onto cylinder rod.
- Slowly lower boom until lock stops travel.

## CAUTION

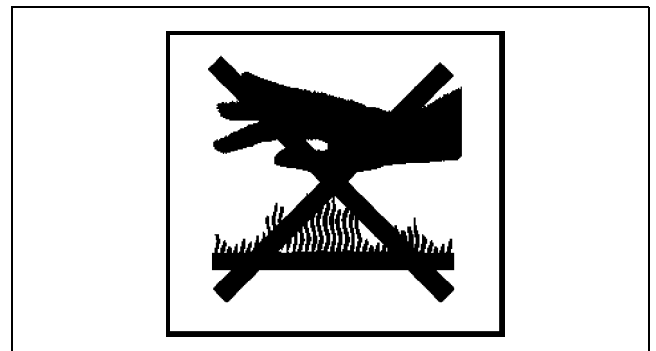

MIF

**Picture Note: Molded onto muffler.**

**No-text warning: Hot Surface.**

- Do not touch engine muffler, it may be hot.

# SAFETY LABELS

## WARNING KV15055



KV15055

To avoid injury, keep hands and feet away from this area.

**AVOID DEATH OR SERIOUS INJURY - Read and understand Operator's Manual before operating this machine.**

- Operate only from seat.
- Before leaving seat: Lower working tools to ground, place in neutral and engage parking brake.
- Never carry riders.
- Carry working tools low.
- Engage backhoe boom and swing locks before transporting.
- Avoid contact with overhead obstacles when operating or hauling machine.

## WARNING LVU16682



LVU16682

- DO NOT PURGE VALVE WHILE ENGINE IS WARM AND WITHOUT FIRST READING OPERATOR'S MANUAL.
- VALVE WILL RELEASE HOT PRESSURIZED COOLANT AND SERIOUS INJURY MAY RESULT.

## WARNING LVU10707



LVU10707a

**AVOID CRUSHING. Do not jump if machine tips.**

- USE SEAT BELT.

## CAUTION T146080



T146080

## Warning M159705



M159705

**Picture Note: This label is required and installed on machines sold in California. This label may also be installed on machines sold in other locations.**

# SAFETY LABELS

Operation of This Equipment May Create Sparks that Can Start Fires Around Dry Vegetation. A Spark Arrestor May be Required. The Operator Should Contact Local Fire Agencies For Laws or Regulations Relating to Fire Prevention Requirements.

**To maintain unimpaired operator protection and manufacturer's ROPS certification:**

- Damaged ROPS structures must be replaced, not repaired or revised.
- Any alteration to the ROPS must be approved by the manufacturer.

## WARNING T188815



T188815

- STAY CLEAR of swing area.
- Operate controls only from seat.
- DO NOT enter or exit from this side.

## ROLL-OVER PROTECTIVE STRUCTURE CERTIFICATION

Performance certified at date of manufacture to:

OSHA: 1926. 1001

ROPS:

SAE: J/ISO 3471 NOV99 J/1040 MAY 94

ISO: 3471: 1994

FOPS:

SAE: J/ISO 3449 APR98 LEVEL 1 J/1040 MAY 94

ISO: 3449: 1992 LEVEL 1

Maximum Machine Weight: 9,000 lbs (4085 kgs)

John Deere Tractor Model 110

Deere & Company Moline, Illinois

## ROLL-OVER PROTECTIVE STRUCTURE LVU13567



LVU13567

## Emission Control System Certification Label

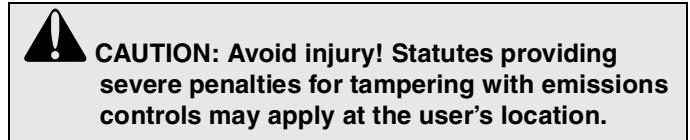
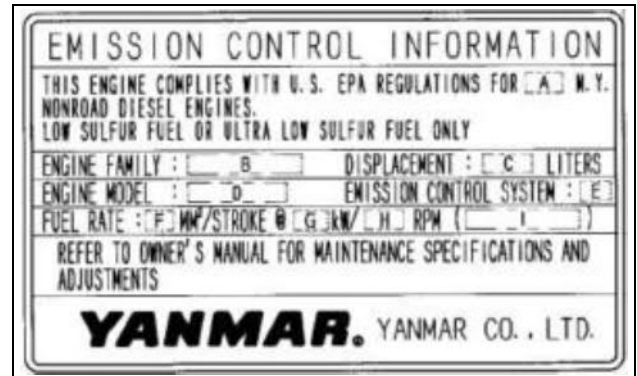

The emissions warranty described in the warranty section applies only to those engines marketed by John Deere that have been certified by the United States Environmental Protection Agency (EPA) and/or California Air Resources Board (CARB); and used in the United States in non-road mobile (self-propelled or portable/transportable<sup>1</sup>) equipment. The presence of an emissions label like the one shown signifies that the engine has been certified with the

## SAFETY LABELS

---

EPA and/or CARB. The EPA and CARB warranties only apply to new engines having the certification label affixed to the engine and sold as stated above in the geographic areas governed by the regulating agencies.

***NOTE: The hp/kW rating on the engine emissions certification label specifies the gross engine hp/kW, which is flywheel power without fan. In most applications this will not be the same rating as the advertised vehicle hp/kW rating.***

---

1. Equipment moved at least once every 12 months.

# SAFETY

---

## Operator Training Required

- Read the operator's manual and other training material. If the operator or mechanic cannot read English, it is the owner's responsibility to explain this material to them. This publication is available in other languages.
- Become familiar with the safe operation of the equipment, operator controls, and safety signs.
- All operators and mechanics should be trained. The owner of the machine is responsible for training the users.
- Never let children or untrained people operate or service the equipment. Local regulations may restrict the age of the operator.
- The owner/user can prevent and is responsible for accidents or injuries occurring to themselves, other people, or property.
- Operate the machine in an open, unobstructed area under the direction of an experienced operator.

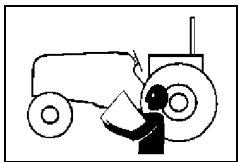

## Operating Machine Safely

- Inspect machine before you operate. Be sure hardware is tight. Repair or replace damaged, badly worn, or missing parts. Be sure

guards and shields are in good condition and fastened in place. Make any necessary adjustments before you operate.

- Check before each use that operator presence controls are functioning correctly. Test safety systems. Do not operate unless they are functioning correctly.
- Check brake action before you operate. Adjust or service brakes as necessary.
- Stop machine if anyone enters the area.
- If you hit an object, stop and inspect the machine. Make repairs before you operate. Keep machine and implements properly maintained and in good working order.
- Do not leave machine unattended when it is running.
- Only operate during daylight or with good artificial light.
- Use only accessories and implements approved by the manufacturer of the machine.

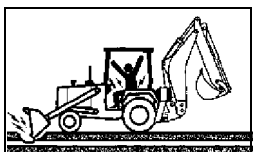

## Operating Backhoe Safely

- Check with local utility companies before digging to verify location of cables, gas lines and water lines.
- Avoid accidental machine

movement. Before turning seat around:

- Lower stabilizers so rear wheels are just off the ground.
- Lower loader bucket to the ground (rolled forward if possible).
- Lock park brake.
- Use the repositioning creeper drive speed control to reposition the machine. On level ground, an experienced operator may use the backhoe bucket to move the machine. Level machine with stabilizers after moving machine.
- Set stabilizers on firm surface. Do not dig under stabilizers. Be alert to possible machine movement when raising stabilizers and loader bucket.
- Avoid swinging bucket downhill when operating on a slope. Dump on uphill side if possible.
- Move boom slowly when raising loaded bucket to full height.
- Clear all persons from area of operation and machine movement.
- If you must drive on slopes, move backhoe to the uphill side for added stability.

## Using a Spark Arrestor

The engine in this machine is not equipped with a spark arrestor muffler. The California Public Resources Code, section 4442.5 provides as follows:

No person shall sell, offer for sale, lease, or rent to any person any internal combustion engine subject to Section 4442 or 4443, and not subject to Section 13005 of the Health and Safety Code, unless the person provides a written notice to the purchaser or bailee, at the time of sale or at the time of entering into the lease or rental contract, stating that it is a violation of Section 4442 or 4443 to use or operate the engine on any forest-covered, brush-covered, or grass-covered land unless the engine is equipped with a spark arrestor, as defined in Section 4442, maintained in effective working order or the engine is constructed, equipped, and maintained for the prevention of fire pursuant to Section 4443. Cal. Pub. Res. Code 4442.5.

Other states or jurisdictions may have similar laws. A spark arrestor for your machine may be available from your authorized dealer. An installed spark arrestor must be maintained in good working order by the operator.

# SAFETY

## Parking Safely

1. Stop machine on a level surface, not on a slope.
2. Lower all equipment to the ground.
3. If servicing engine, raise front loader boom and install loader boom service lock.
4. Disengage the PTO.
5. Lock park brake.
6. Stop engine.
7. Wait for engine and all moving parts to stop before you leave the operator's station.
8. Remove key.

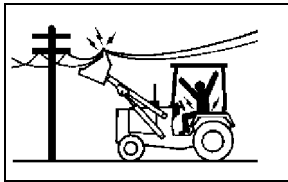

## Avoid Overhead Power Lines

Keep away from power lines. Serious injury or death will result. Never move any part of machine or load closer to power

line than 3m (10 ft.) plus twice the line insulator length.

## Protect Children and Prevent Accidents

### Protect Children:

- Stay alert to the presence of children. Never assume that children will remain where you last saw them. Turn the machine off if a child enters the work area.
- Do not let children or an untrained person operate the machine. Instruct all operators not to give a ride on the machine or in an attachment.

### Help Prevent Serious Or Fatal Accidents:

- Be alert at all times; drive forward carefully. People, especially children, can move quickly onto the worksite unnoticed.
- An operator must continuously be aware of all co-workers who share the worksite.
- Back up carefully. An operator must always look to each side and to the rear for bystanders before backing up.

## Keep Riders Off

- Only allow the operator on the machine. Keep riders off.
- Riders on the machine or attachment may be struck by foreign objects or thrown off the machine causing serious injury.

- Riders obstruct the operator's view resulting in the machine being operated in an unsafe manner.

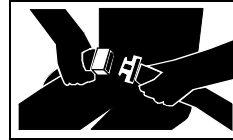

## Use Seat Belt Properly

- Use a seat belt when you operate with a Roll-Over Protective Structure (ROPS) to minimize chance of injury from an accident, such as an overturn.
- Never modify, disassemble or attempt to repair the seat belt.
- Replace entire seat belt if mounting hardware, buckle, belt, or retractor show signs of damage.
- Inspect seat belt and mounting hardware at least once a year. Look for signs of loose hardware or belt damage, such as cuts, fraying, extreme or unusual wear, discoloration, or abrasion. Replace only with John Deere-approved replacement parts.
- Layers of heavy clothing can interfere with proper positioning of the seat belt and can reduce the effectiveness of the seat belt.

## Keep ROPS Installed Properly

- Never operate the machine without the ROPS installed.
- Make certain all parts of the ROPS are installed correctly if the ROPS structure is loosened or removed for any reason. All ROPS hardware should be tightened to the proper torque per manufacturer's recommendations.
- Any alteration of the ROPS must be approved by the manufacturer. The protection provided by the ROPS will be impaired if the ROPS is subjected to structural damage, is involved in an overturn incident, or is in any way altered by welding, bending, drilling, or cutting.
- The seat is part of the ROPS safety zone. Replace only with John Deere-approved seat.
- Never attempt to repair a damaged or altered ROPS. It must be replaced to maintain the manufacturer's certification of the structure.

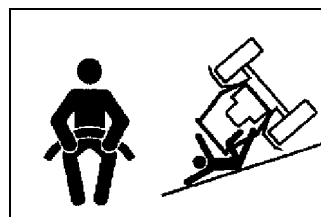

## Avoid Injury From Rollover Accidents

- Wear your seat belt. Do not jump to clear tipping machine. Machine will tip over faster than the operator can jump free.

# SAFETY

---

- Be careful when operating on a slope.
- Avoid sharp turns.
- Balance loads so weight is evenly distributed and load is stable.
- Carry tools close to the ground to aid visibility and lower the center of gravity.
- Reduce speed before turning or swinging load.
- Know capacity of machine. Do not overload.
- Be careful when operating at the edge of an excavation, trench, or drop-off, and loading or unloading from a trailer.



## Avoid Injury From Backover Accidents

- Know the location of bystanders before moving the machine.
- Always look behind you before you back up. Be sure that everyone is out of the way before moving the machine.
- Use horn or other signal to warn bystanders before moving machine.
- Keep bystanders away from pivot area of an articulated machine.
- Keep reverse warning alarm in working condition to warn people when machine starts to move in reverse.
- Use a signal person when backing up if view is obstructed and in congested areas. Always keep the signal person in view.
- Learn the meaning of all flags, signs and markings used on the job, and who has responsibility for signaling.
- Keep windows, mirrors, and lights clean and in good condition.
- Dust, heavy rain and fog can reduce visibility. As visibility decreases, reduce speed and use proper lighting.

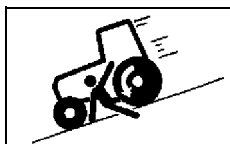

## Avoid Injury From Rollaway Accidents

- Always make sure the machine is properly secured and park safely before leaving the operator's station.
- Do not attempt to get on or stop a moving machine.
- Position the machine or block the wheels to prevent the machine from rolling.

## Checking Wheel Hardware

- A serious accident could occur causing serious injury if wheel hardware is not tight.
- Check wheel hardware tightness often during the first 100 hours of operation.
- Wheel hardware must be tightened to specified torque using the proper procedure anytime it is loosened.

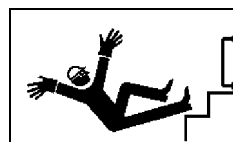

## Using Handholds and Steps

- Falling is a major cause of personal injury. Keep steps and platform clean and dry if possible.
- Be careful of slippery conditions on platforms, steps, and handrails when leaving the machine.
- When you get on and off the machine, always maintain a three point contact with steps and handrails and face the machine. Do not use steering wheel or any controls as handholds.
- Never jump on or off the machine. Never mount or dismount a moving machine.

## Towing Loads Safely

- Stopping distance increases with speed and weight of towed load. Travel slowly and allow extra time and distance to stop.
- Total towed weight must not exceed combined weight of pulling machine, ballast and operator. Use counterweights or wheel weights as described in the attachment or pulling machine operator's manual.
- Excessive towed load can cause loss of traction and loss of control on slopes. Reduce towed weight when operating on slopes.
- Never allow children or others in or on towed equipment.
- Use only approved hitches. Tow only with a machine that has a hitch designed for towing. Do not attach towed equipment except at the approved hitch point.
- Follow the manufacturer's recommendations for weight limits for towed equipment and towing on slopes.
- If you cannot back up a slope with a towed load, the slope is too steep to operate on with the towed load. Reduce the towed load or do not operate.
- Do not turn sharply. Use additional caution when turning or operating under adverse surface conditions. Use care when reversing.
- Do not shift to neutral and coast downhill.

# SAFETY

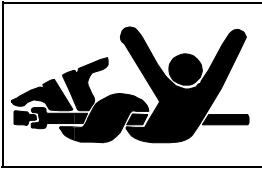

## Stay Clear of Rotating Drivelines

Entanglement in rotating driveline can cause serious injury or death.

- Wear close fitting clothing.
- Stop the engine and be sure PTO driveline is stopped before getting near it.

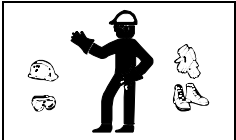

## Wear Appropriate Clothing

• Always wear safety goggles, or safety glasses with side shields, and a hard hat when operating the machine.

- Wear close fitting clothing and safety equipment appropriate for the job.
- Wear a suitable protective device such as earplugs. Loud noise can cause impairment or loss of hearing.

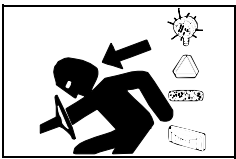

## Driving Safely on Public Roads

Avoid personal injury or death resulting from a collision with another vehicle on public roads:

- Use safety lights and devices. Slow moving machines when driven on public roads are hard to see, especially at night.
- Whenever driving on public roads, use flashing warning lights and turn signals according to local regulations. Extra flashing warning lights may need to be installed.

## Using Loader Boom Service Lock

### Installing Loader Boom Service Lock

Install loader boom service lock when front loader must be raised for service procedures.

1. Empty loader bucket and place in dump position.



MX13690

### Picture Note: Storage position shown.

2. Raise boom until boom lock channel can be positioned on cylinder rod, then stop engine.
3. Remove spring locking pin (A) and retaining pin (B) and lower lock onto cylinder rod.
4. Install retaining pin (B) in lock hole (C) and secure with spring locking pin (A).
5. Slowly lower boom until weight settles onto the loader boom service lock.

### Removing Loader Boom Service Lock

1. Start engine.
2. Raise boom slightly to allow clearance between loader boom service lock and cylinder.
3. Remove spring locking pin and retaining pin.
4. Lift loader boom service lock to storage position.
5. Install the retaining pin and spring locking pin.

## Prevent Machine Runaway

- Do not start engine by shorting across starter terminals. Machine will start in gear if normal circuitry is bypassed.
- Never start engine while standing on ground. Start engine only from operator's seat, with transmission in neutral or park.

# SAFETY



## Practice Safe Maintenance

- Only qualified, trained adults should service this machine. Understand service procedure before doing work.
- Never operate machine in a closed area where dangerous carbon monoxide fumes can collect.
- Keep all nuts and bolts tight, especially blade attachment bolts, to be sure the equipment is in safe working condition.
- Never tamper with safety devices. Check their proper operation regularly.
- Keep machine free of grass, leaves or other debris build-up. Clean up oil or fuel spillage and remove any fuel-soaked debris. Allow the machine to cool before storing.
- Never make any adjustments or repairs with the engine running. Wait for all movement to stop on machine before adjusting, cleaning or repairing.
- Check brake operation frequently. Adjust and service as required.
- Maintain or replace safety and instruction labels, as necessary.
- Keep hands, feet, clothing, jewelry, and long hair away from any moving parts, to prevent them from getting caught.
- Lower any attachments to the ground before cleaning or servicing machine. Disengage all power and stop the engine. Lock park brake and remove the key. Let machine cool.
- Securely support any machine elements that must be raised for service work. Use jack stands or lock service latches to support components when needed.
- Disconnect battery or remove spark plug wire (for gasoline engines) before making any repairs. Disconnect negative terminal first and positive last. Install positive terminal first and negative last.
- Before servicing machine or attachment, carefully release pressure from any components with stored energy, such as hydraulic components or springs.
- Release hydraulic pressure by lowering attachment or cutting units to the ground or to a mechanical stop and move hydraulic control levers back and forth.
- Keep all parts in good condition and properly installed. Fix damage immediately. Replace worn or broken parts.
- Charge batteries in an open, well-ventilated area, away from sparks. Unplug battery charger before connecting or disconnecting from the battery. Wear protective clothing and use insulated tools.

## Remove Paint Before Welding or Heating

- Avoid potentially toxic fumes and dust.
- Hazardous fumes can be generated when paint is heated by welding, soldering, or using a torch.
- Remove paint before heating:
  - Remove paint a minimum of 76mm (3 in.) from areas to be affected by heating.
  - If you sand or grind paint, avoid breathing the dust. Wear an approved respirator.
  - If you use solvent or paint stripper, remove stripper with soap and water before welding. Remove solvent or paint stripper containers and other flammable material from area. Allow fumes to disperse at least fifteen minutes before welding or heating.
- Do all work in an area that is ventilated to carry toxic fumes and dust away.
- Dispose of paint and solvent properly.



## Avoid High Pressure Fluids

- Hydraulic hoses and lines can fail due to physical damage, kinks, age, and exposure. Check hoses and lines regularly. Replace damaged hoses and lines.
- Hydraulic fluid connections can loosen due to physical damage and vibration. Check connections regularly. Tighten loose connections.
- Escaping fluid under pressure can penetrate the skin causing serious injury. Avoid the hazard by relieving pressure before disconnecting hydraulic or other lines. Tighten all connections before applying pressure.
- Search for leaks with a piece of cardboard. Protect hands and body from high pressure fluids.
- If an accident occurs, see a doctor immediately. Any fluid injected into the skin must be surgically removed within a few hours or gangrene may result. Doctors unfamiliar with this type of injury should reference a knowledgeable medical source. Such information is available from Deere & Company Medical Department in Moline, Illinois, U.S.A. Information may be obtained in the United States and Canada only by calling 1-800-822-8262.

## Avoid Heating Near Pressurized Fluid Lines

Flammable spray can be generated by heating near pressurized fluid lines, resulting in severe burns to yourself and bystanders. Do not heat by welding, soldering or using



**Suggest:**

**If the above button click is invalid.**

**Please download this document**

**first, and then click the above link**

**to download the complete manual.**

**Thank you so much for reading**

# SAFETY

a torch near pressurized fluid lines or other flammable materials. Pressurized lines can be accidentally cut when heat goes beyond the immediate flame area.

## Prevent Fires

- Remove grass and debris from engine compartment and muffler area, before and after operating machine.
- Always shut off fuel when storing or transporting machine, if the machine has a fuel shutoff.
- Do not store machine near an open flame or source of ignition, such as a water heater or furnace.
- Check fuel lines, tank, cap, and fittings frequently for cracks or leaks. Replace if necessary.

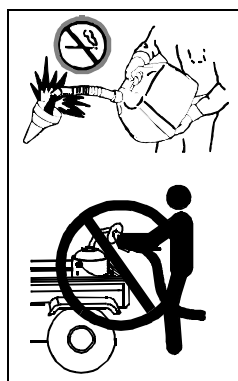

## Handling Fuel Safely

**To avoid personal injury or property damage, use extreme care in handling fuel. Fuel is extremely flammable and fuel vapors are explosive:**

- Extinguish all cigarettes, cigars, pipes, and other sources of ignition.
- Use only an approved fuel container. Use only non-metal, portable fuel containers approved by the Underwriter's Laboratory (U.L.) or the American Society for Testing & Materials (ASTM). If using a funnel, make sure it is plastic and has no screen or filter.
- Never remove the fuel tank cap or add fuel with the engine running. Allow engine to cool before refueling.
- Never add fuel to or drain fuel from the machine indoors. Move machine outdoors and provide adequate ventilation.
- Clean up spilled fuel immediately. If fuel is spilled on clothing, change clothing immediately. If fuel is spilled near machine, do not attempt to start the engine but move the machine away from the area of spillage. Avoid creating any source of ignition until fuel vapors have dissipated.
- Never store the machine or fuel container where there is an open flame, spark, or pilot light such as on a water heater or other appliance.
- Prevent fire and explosion caused by static electric discharge. Static electric discharge can ignite fuel vapors in an ungrounded fuel container.
- Never fill containers inside a vehicle or on a truck or trailer bed with a plastic liner. Always place containers on the ground away from your vehicle before fueling.

- Remove fuel-powered equipment from the truck or trailer and refuel it on the ground. If this is not possible, then refuel such equipment with a portable container, rather than from a fuel dispenser nozzle.
- Keep the nozzle in contact with the rim of the fuel tank or container opening at all times until the fueling is complete. Do not use a nozzle lock-open device.
- Never overfill fuel tank. Replace fuel tank cap and tighten securely.
- Replace all fuel container caps securely after use.
- For gasoline engines, do not use gas with methanol. Methanol is harmful to your health and to the environment.



## Tire Safety

Explosive separation of a tire and rim parts can cause serious injury or death:

- Do not attempt to mount a tire without the proper equipment and experience to perform the job.
- Always maintain the correct tire pressure. Do not inflate the tires above the recommended pressure. Never weld or heat a wheel and tire assembly. The heat can cause an increase in air pressure resulting in a tire explosion. Welding can structurally weaken or deform the wheel.
- When inflating tires, use a clip-on chuck and extension hose long enough to allow you to stand to one side and NOT in front of or over the tire assembly.
- Check tires for low pressure, cuts, bubbles, damaged rims or missing lug bolts and nuts.

## Handling Waste Product and Chemicals

Waste products, such as, used oil, fuel, coolant, brake fluid, and batteries, can harm the environment and people:

- Do not use beverage containers for waste fluids - someone may drink from them.
- See your local Recycling Center or authorized dealer to learn how to recycle or get rid of waste products.
- A Material Safety Data Sheet (MSDS) provides specific details on chemical products: physical and health hazards, safety procedures, and emergency response techniques. The seller of the chemical products used with your machine is responsible for providing the MSDS for that product.

**<https://www.ebooklibonline.com>**

Hello dear friend!

Thank you very much for reading.

Enter the link into your browser.

The full manual is available for immediate download.

**<https://www.ebooklibonline.com>**