



# 100 Stack Wagon



JOHN DEERE

## TECHNICAL MANUAL 100 Stack Wagon

TM1144 (01NOV77) English

**Des Moines Works**  
**TM1144 (01NOV77)**

LITHO IN U.S.A.  
ENGLISH



# 100 STACK WAGON Technical Manual TM-1144 (Nov-77)

## CONTENTS

INTRODUCTION .....	2	ROTOR AND ROTOR DRIVE .....	17-21
SAFETY AND YOU .....	3	Rotor Belt Replacement .....	17-18
GENERAL INFORMATION .....	4-5	Rotor Sheave Replacement .....	18-19
Description .....	4	Rotor Bearing Replacement .....	19-20
Serial Number .....	4	Rotor Replacement .....	20-21
Lubrication .....	5	UNLOADING DRIVE .....	22-25
DIAGNOSING MALFUNCTIONS .....	6-7	Unloading Drive Sheave Replacement .....	22
POWERSHAFT .....	8-11	Unloading Sheave-and-Sprocket	
General Information .....	8	Replacement .....	22
Removal and Installation .....	8	Unloading Belt Replacement .....	23
Disassembly .....	8-10	Double Sprocket Replacement .....	23
Inspection and Repair .....	10	Drive Tube, Bearing, and	
Assembly .....	11	Sprocket Replacement .....	24-26
INPUT SHAFT .....	11	HYDRAULIC CYLINDERS .....	26-31
GEAR CASE .....	12-15	General Information .....	26-27
General Information .....	12	Removal .....	28
Removal .....	12	Disassembly .....	28-30
Installation .....	12	Inspection and Repair .....	30
Disassembly .....	12-13	Assembly and Installation .....	30-31
Inspection and Repair .....	14	SPECIFICATIONS .....	32
Assembly .....	14-15		
CLUTCH .....	15-17		
General Information .....	15		
Removal .....	15-16		
Inspection .....	16-17		
Assembly .....	17		

*All information, illustrations and specifications contained in this technical manual are based on the latest information available at the time of publication. The right is reserved to make changes at any time without notice.*

Copyright © 1977  
DEERE & COMPANY  
Moline, Illinois  
All rights reserved

## INTRODUCTION

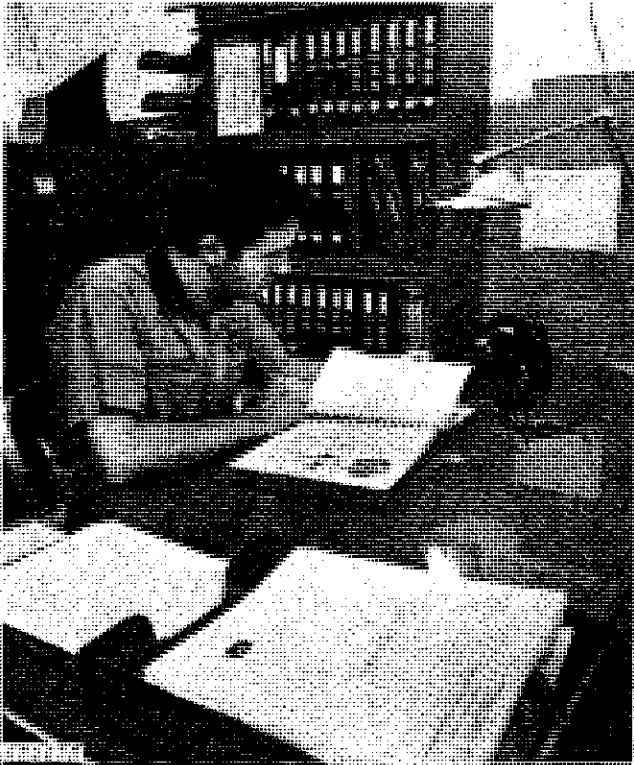

*Use FOS Manuals for Reference*

This technical manual is part of a twin concept of service:

- **FOS Manuals—**for reference
- **Technical Manuals—**for actual service

The two kinds of manuals work as a team to give you both the general background and technical details of shop service.

*Fundamentals of Service (FOS) Manuals* cover basic theory of operation, *fundamentals* of trouble shooting, *general* maintenance, and *basic* types of failures and their causes. FOS Manuals are for training new people and for reference by experienced technicians.

*Technical Manuals* are concise service guides for a specific machine. Technical Manuals are on-the-job guides containing only the vital information needed by an experienced technician.

**NOTE:** Whenever the service technician may need to refer to a FOS Manual for additional information, a specific manual, chapter and/or page number is given.

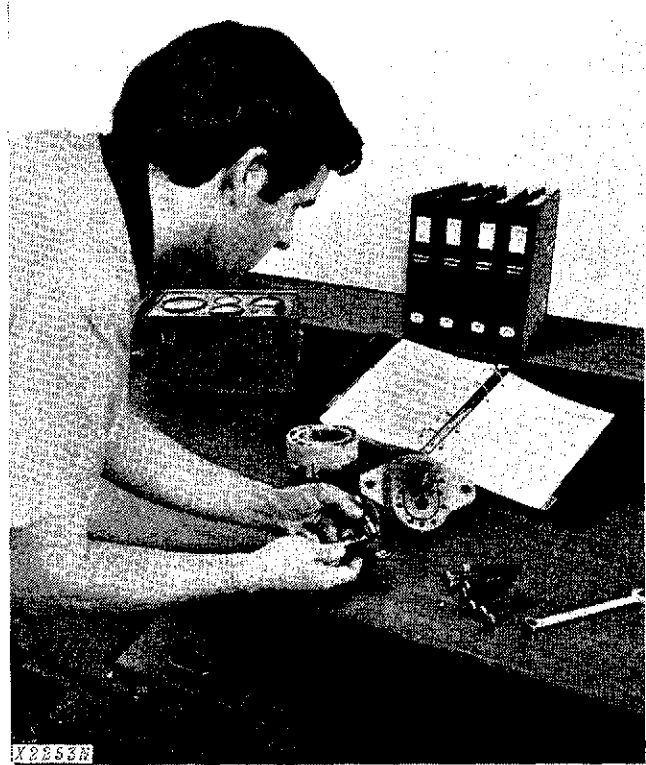

*Use Technical Manuals for Actual Service*

Some features of this technical manual:

- *Table of contents at front of manual*
- *Exploded views showing parts relationship*
- *Photos showing service techniques*
- *Specifications grouped for easy reference*

This technical manual was planned and written for you—an experienced technician. Keep it in a permanent binder in the shop where it is handy. Refer to it whenever in doubt about correct service procedures or specifications.

Using the technical manual as a guide will reduce error and costly delay. It will also assure you the best in finished service work.



This safety alert symbol identifies important safety messages in this manual. When you see this symbol, be alert to the possibility of personal injury and carefully read the message that follows.

Because John Deere sells its products world-wide, U.S. units of measure are shown with their respective Metric equivalents throughout this technical manual. These equivalents are the SI (International System) Units of Measure.

### FOR YOUR CONVENIENCE

Vertical lines appear in the margins of many of the pages. These lines identify new material and revised information that affects specifications, procedures, and other important instructions.

**<https://www.ebooklibonline.com>**

Hello dear friend!

Thank you very much for reading.

Enter the link into your browser.

The full manual is available for immediate download.

**<https://www.ebooklibonline.com>**

## SAFETY AND YOU



T27993N

### INTRODUCTION

 This safety alert symbol identifies important safety messages in this manual and on the drill. When you see this symbol, be alert to the possibility of personal injury and carefully read the message that follows.

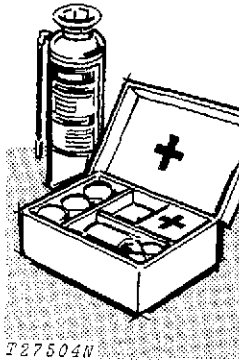

T27504N

Be prepared if an accident or fire should occur. Know where the first-aid kit and the fire extinguishers are located—know how to use them.

### PERSONAL SAFETY

Shut off tractor engine and remove switch key before working on the stack wagon, when it is attached to the tractor.

If it is necessary to make checks with the tractor engine running, ALWAYS USE TWO PEOPLE—one, the operator, at the controls, the other person checking so as to be visible to the operator on the tractor seat. KEEP HANDS AWAY FROM MOVING PARTS.

RIGHT



H23440N

Always avoid loose clothing or any accessory—flopping cuffs, dangling neckties and scarves—that can catch in moving parts and put you out of work.

Always wear your safety glasses while on the job.

Before removing any housing covers, stop engine. Take all objects from your pockets which could fall into the opened housings. Don't let adjusting wrenches fall into opened housings.

Don't attempt to check belt tension while the engine is running.

### FLUIDS UNDER PRESSURE

Escaping fluid under pressure can have sufficient force to penetrate the skin, causing serious personal injury. Before disconnecting lines, be sure to relieve all pressure. Before applying pressure to the system, be sure all connections are tight and lines, pipes and hoses are not damaged.

Fluid escaping from a very small hole can be almost invisible. Use a piece of cardboard or wood, rather than hands, to search for suspected leaks.

If injured by escaping fluid, see a doctor at once. Serious infection or reaction can develop if proper medical treatment is not administered immediately.

## GENERAL INFORMATION

### DESCRIPTION

The John Deere 100 Stack Wagon consists of three basic units: the pickup unit, the compression chamber, and the unloading mechanism.

The stack wagon rotor and unloading drive are driven by a 540-rpm PTO of a 60 HP or larger tractor. A double-disk friction slip clutch is located between the gear case and the rotor drive. It is designed to slip if the rotor assembly encounters an obstruction that would cause more than 300 ft-lbs (408 Nm) of torque to be transferred to the clutch.

The pickup is raised and lowered by a single- or double-acting remote hydraulic cylinder (customer furnished) that is controlled by one of the tractor control levers.

The compression chamber canopy is raised and lowered by double-acting cylinders that are controlled by another of the tractor control levers. Material placement in the wagon is controlled by a deflector which is raised and lowered by a canopy actuated cable.

The door is opened and closed by opening a valve with the control rope—allowing compression chamber cylinder oil to operate the door cylinder. Only when the door is open can the unloading chain move the stack out of the wagon—the unloading speed controlled by the PTO lever.

### SERIAL NUMBER

The serial number for the stack wagon is located on the front right-hand side of the main frame.

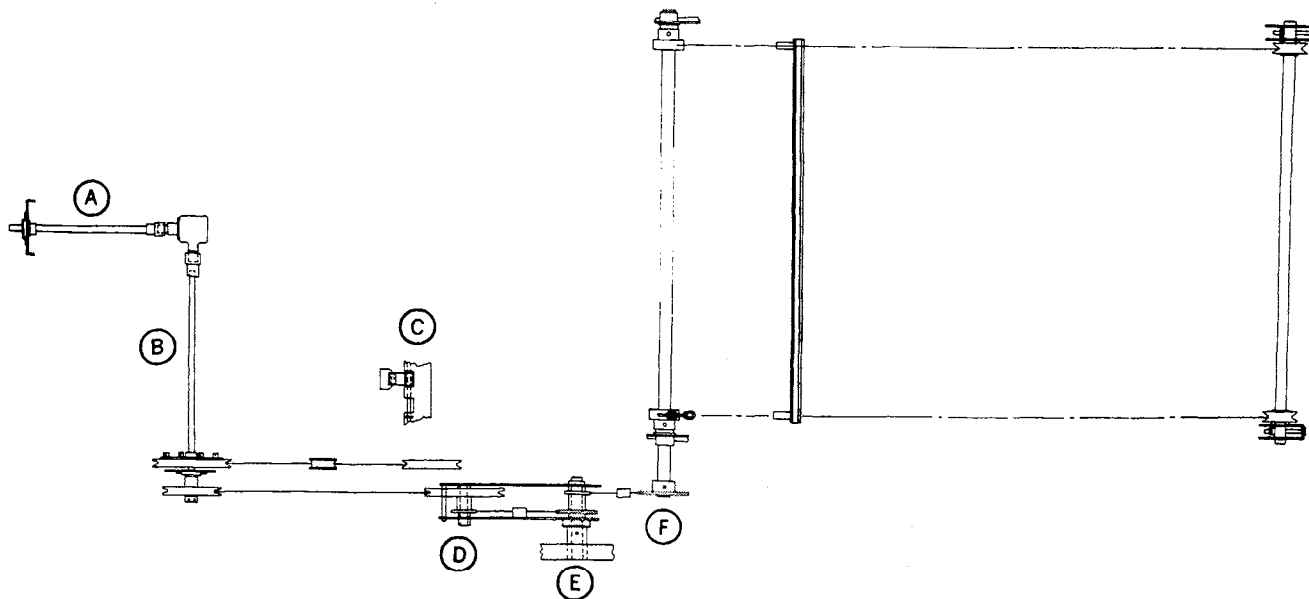

N29802N

A—Input Shaft, 540 RPM  
B—Output Shaft, 1002 RPM  
C—Rotor, 1537 RPM

D—Unloading Sheave, 387 RPM\*  
E—Unloading Sprocket Assembly, 145 RPM\*  
F—Unloading Log Chain, 72 RPM\*

(\* - with tractor engine running at 1000 rpm)

Fig. 1-Drive Train Diagram

## LUBRICATION

System	Capacity	Type of Lubricant
Powershaft (center fitting)	One or two grease gun strokes	John Deere Multi-Purpose Lubricant or an equivalent SAE multipurpose-type grease
Powershaft U-Joints	One or two grease gun strokes	John Deere Multi-Purpose Lubricant or an equivalent SAE multipurpose-type grease
Powershaft Rotating Shield Inner Surface	Light Coating	John Deere Multi-Purpose Lubricant or an equivalent SAE multipurpose-type grease
Roller Chains	----	John Deere PT 508 Chain Lube or an equivalent SAE lubricant
<i>NOTE: As an alternative method of lubrication, flush the chains with SAE 30 engine oil sufficient to wash away accumulated dirt. Wipe away excess oil.</i>		
Pickup Rotor Bearings	Two or three grease gun strokes	John Deere Multi-Purpose Lubricant or an equivalent SAE multipurpose-type grease
Unloading Drive Bearings	Two or three grease gun strokes	John Deere Multi-Purpose Lubricant or an equivalent SAE multipurpose-type grease
Unloading Chain Bearings	One or two grease gun strokes	John Deere Multi-Purpose Lubricant or an equivalent SAE multipurpose-type grease
Cables, Pulleys, and Latches	A few drops	SAE 30 engine oil
Wheel Bearings	----	John Deere Multi-Purpose Lubricant or an equivalent SAE multipurpose-type grease
Gear Case	2-3/4 in. (70 mm) below filler plug	John Deere SAE 90 Gear Lubricant or an equivalent SCL multipurpose-type gear oil

# DIAGNOSING MALFUNCTIONS AND TESTING

## ORGANIZING THE DIAGNOSIS

### 1. Know the Unit

Study this manual to know how the individual components work and their function in the over-all system.

Keep up with the latest service information. Read it and store it in a handy reference file.

### 2. Consult the Operator

Ask the operator how the unit was performing when the problem occurred. Find out if any corrective measures were already taken. Ask if the unit was serviced regularly as prescribed in the operator's manual.

### 3. Operate the Unit

If the unit can be safely operated, see for yourself how it malfunctions—don't completely rely on the operator's diagnosis.

### 4. Inspect the Unit

Visually check the unit. Look at the components for any cracked welds, loose hardware, damaged linkages, worn or broken lines, or anything that looks out of the ordinary.

### 5. List the Probable Causes

Write down the information you have learned by steps 1 through 4. What are the signs you found while inspecting the unit and what are the most probable causes as outlined under "Diagnosing"?

### 6. Reach Some Conclusions

Look over the possible causes and decide which ones are most likely. Reach your decision on the most probable cause and plan to check it first.

### 7. Test Your Conclusions

Before disassembling any components, test your conclusions to see which are correct. Tests narrow the possibilities and soon the actual cause will be pinpointed.

## DIAGNOSING

### Drive Train

#### **Powershaft will not telescope properly**

Tractor drawbar not adjusted properly, see Operator's Manual.

#### **Universal joint failure**

Telescoping shaft not greased - page 5  
PTO engaged at high speed - reduce speed  
Clutch not working - page 15

#### **Power loss to or from gear case**

Spline failure of input or output hub - page 11

#### **Excessive input shaft vibration**

Input shaft bearing worn - page 11  
Gear case coupling worn - page 11

#### **Noisy gears in gear case - page 12**

Low on lubricant - page 5  
Backlash incorrect - page 15  
Rolling torque incorrect - page 14-15

#### **Clutch slips excessively**

Clutch springs not adjusted equally - page 17  
PTO engaged at high speed - reduce speed  
Worn clutch - page 15

#### **Premature rotor belt wear**

Belt too loose - page 18

#### **Rotor bearing failure**

Belt too tight - page 18  
Improper lubrication - page 5  
Rotor out of balance - replace missing or damaged paddles, page 19.

#### **Premature unloading belt wear**

Belt not adjusted properly - page 23

#### **Unloader drive chain breakage**

Chain idler loose - page 25  
Lack of lubrication - page 5  
Log chain stuck or binding - page 25

### **Bending unloading slats**

- Log chain adjusted incorrectly - page 26
- Tractor PTO engaged when opening rear door -  
Disengage PTO before opening door
- Loading very wet material - Allow material to dry
- Extremely rough and bumpy terrain - slow down

### **Pickup Rotor**

#### **Pickup plugging**

- Deflector not raising - see Operator's Manual
- PTO speed incorrect - see Operator's Manual
- Plugged intake holes - see Operator's Manual
- Ground speed too fast - slow down
- Material too wet - Allow material to dry
- Cutoff improperly adjusted - see Operator's Manual
- Belt slipping - see Operator's Manual
- Improper sequence when raising or lowering the  
canopy - see Operator's Manual
- Clutch slipping - page 17

#### **Excessive vibration**

- Paddles worn unevenly - see Operator's Manual
- Paddles broken - see Operator's Manual
- Paddle links worn - see Operator's Manual
- Bearing loose or worn - page 20

#### **Speed too slow**

- Improper lubrication - page 5

#### **Rotor bearing failure**

- Drive belt too tight - page 18
- Improper lubrication - page 5

## **Hydraulic System**

### **Tractor hydraulic pressure too low**

- Tractor pump defective or out of adjustment - see  
Tractor Technical Manual
- Tractor hydraulic outlets defective - see Tractor  
Technical Manual

### **Canopy lower on one side**

- Air in hydraulic system - page 30
- Wagon parked with canopy up - see Operator's  
Manual
- Compression cylinder internal leakage - page 28
- Cylinders out of phase - page 30
- Tractor hydraulic valves leaking - see Tractor Tech-  
nical Manual

### **Air in hydraulic system**

- Tractor hydraulic valves leaking - see Tractor Tech-  
nical Manual
- Tractor oil reservoir low - refill
- Compression cylinder internal leakage - page 28
- Cylinders or lines leaking - page 27

### **Slow compression time**

- Compression cylinders chatter - page 30
- Low tractor rpm - increase rpm
- Incorrect setting of metering valve - see Operator's  
Manual
- Tractor oil reservoir low - refill

## **Rear Door**

### **Door not latching**

- Cylinder eyebolt out of adjustment - see Operator's  
Manual
- Latches not lubricated properly - page 5
- Cylinder leaking - page 31
- Air in hydraulic system - page 30

## POWERSHAFT

### GENERAL INFORMATION

The powershaft is made up of a front and rear section that slip-fit together. The front section couples to the 540-rpm PTO shaft of the tractor and the rear section is connected to the input shaft of the stack wagon.

The powershaft is fully shielded at the front and at the rear—the drive shield completing full rear protection.

### REMOVAL AND INSTALLATION

1. Push the button and pull straight back to separate the powershaft from the tractor. To connect the powershaft, push the button and slide onto tractor PTO shaft.

The front section easily slides out of the rear section if lubrication recommendations have been followed.

2. To remove the rear section, first remove the right-hand and center shields; this will expose the connection between the powershaft and input shaft.

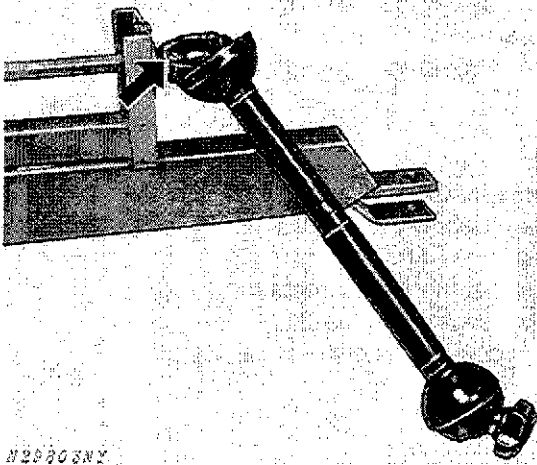

Fig. 2-Removing Powershaft

3. Remove the bolt connecting the powershaft yoke to the grooved input shaft; then pull the powershaft straight off.

4. Install powershaft using reverse of removal steps.

### DISASSEMBLY

**NOTE:** If the powershaft does not telescope properly, damage to the stackwagon will result. Disassemble to replace any parts or to clean the shafts.

1. Place powershaft front section in vise. (Fig. 3).

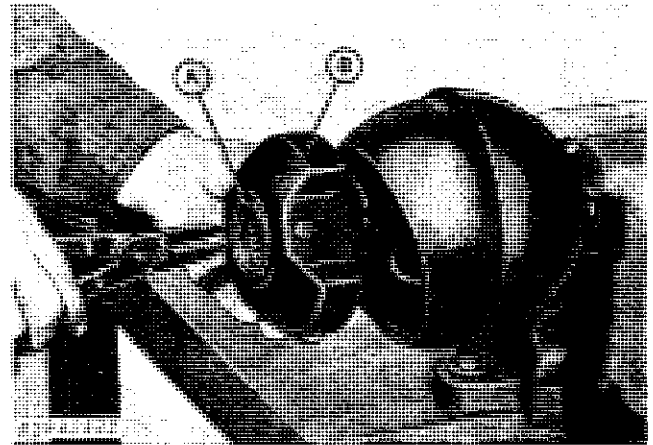

A—Snap Ring

B—Push-Collar Assembly

Fig. 3-Removing Snap Ring

2. Remove the snap ring (A, Fig. 3).

3. Remove the push-collar assembly (B).

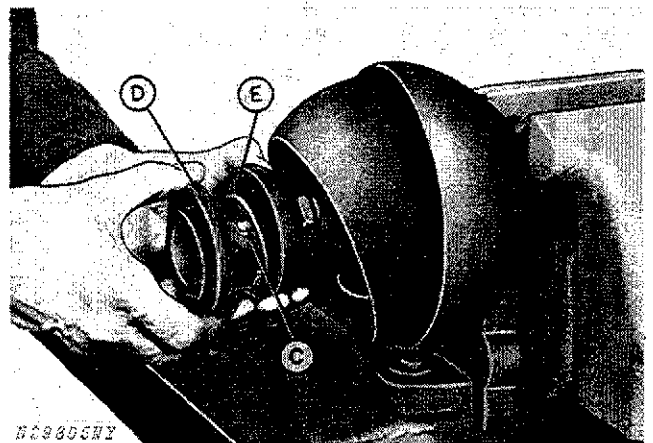

C—Steel Ball

D—Collar Retainer

E—Spring

Fig. 4-Removing Collar Retainer

4. Remove the three steel balls (C, Fig. 4) from the push button yoke; then remove the collar retainer (D) and spring (E).

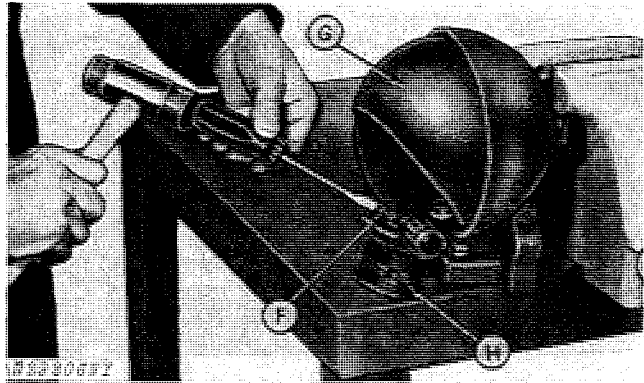

F—Locking Bearing                      G—Closure Shield  
H—Push-Button Yoke

Fig. 5-Removing Front Closure Shield

5. Lift the locking bearing (F, Fig. 5) up and out of the assembly with a screwdriver; drive the bearing out.

6. Remove the closure shield (G) from the push-button yoke (H).

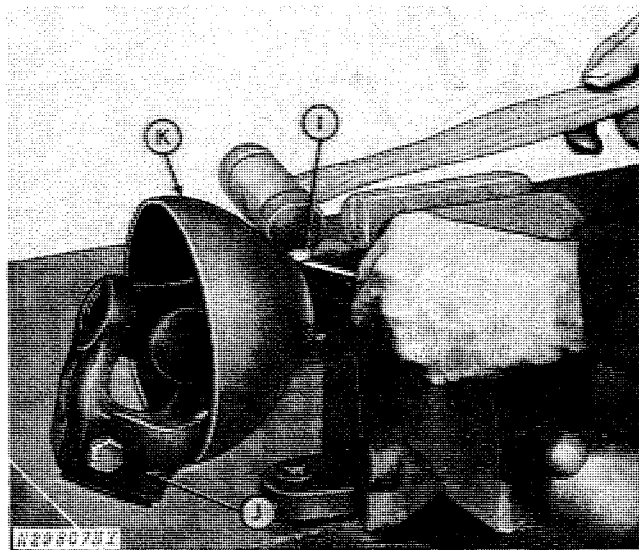

I—Locking Bearing                      J—Yoke and Tube Assembly  
K—Rear Shield

Fig. 6-Removing Rear Shield

7. Remove the locking bearings (I, Fig. 6) from the rear shield (J) in the same manner; then remove the yoke and tube assembly (K).

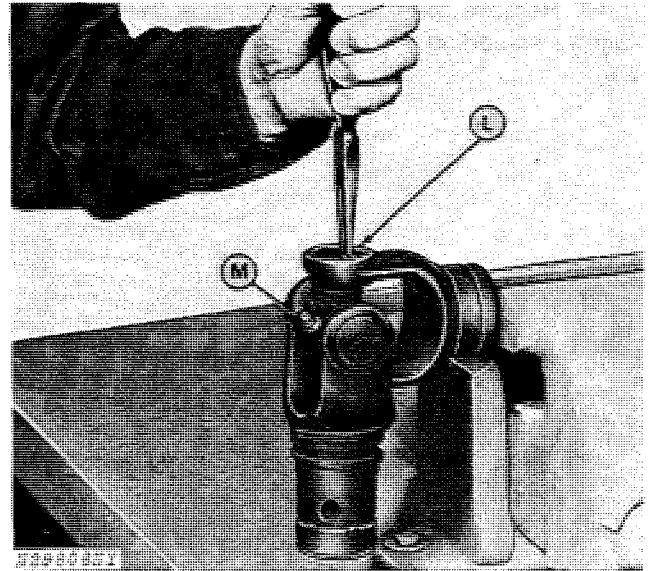

L—Retaining Ring                      M—Spider and Bearing Assembly

Fig. 7-Removing Retaining Rings

8. Support the yoke and shaft assembly in a vise; then remove the retaining rings (L, Fig. 7) from the spider and bearing assembly (M).

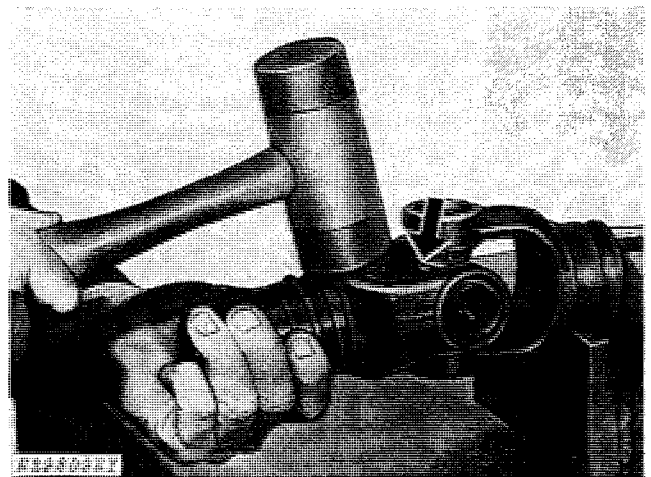

Fig. 8-Removing Spider and Bearing Assembly

9. Drive the spider and bearing assembly from the yoke with a rubber hammer (Fig. 8). Repeat the procedure for the other two bearings, and the yoke and tube assembly.



**Suggest:**

**If the above button click is invalid.**

**Please download this document**

**first, and then click the above link**

**to download the complete manual.**

**Thank you so much for reading**

10. Remove the nylon bearing from the rear section by spreading the ends apart and lifting off (Fig. 9).

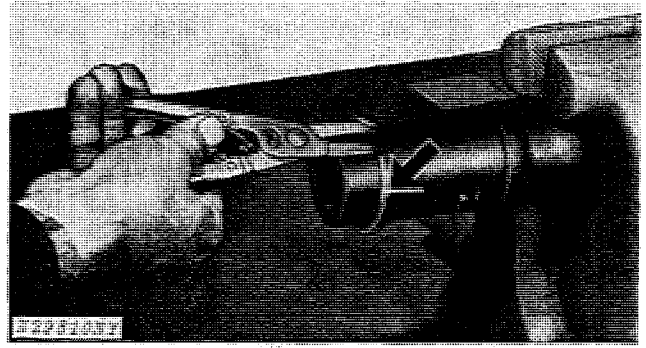
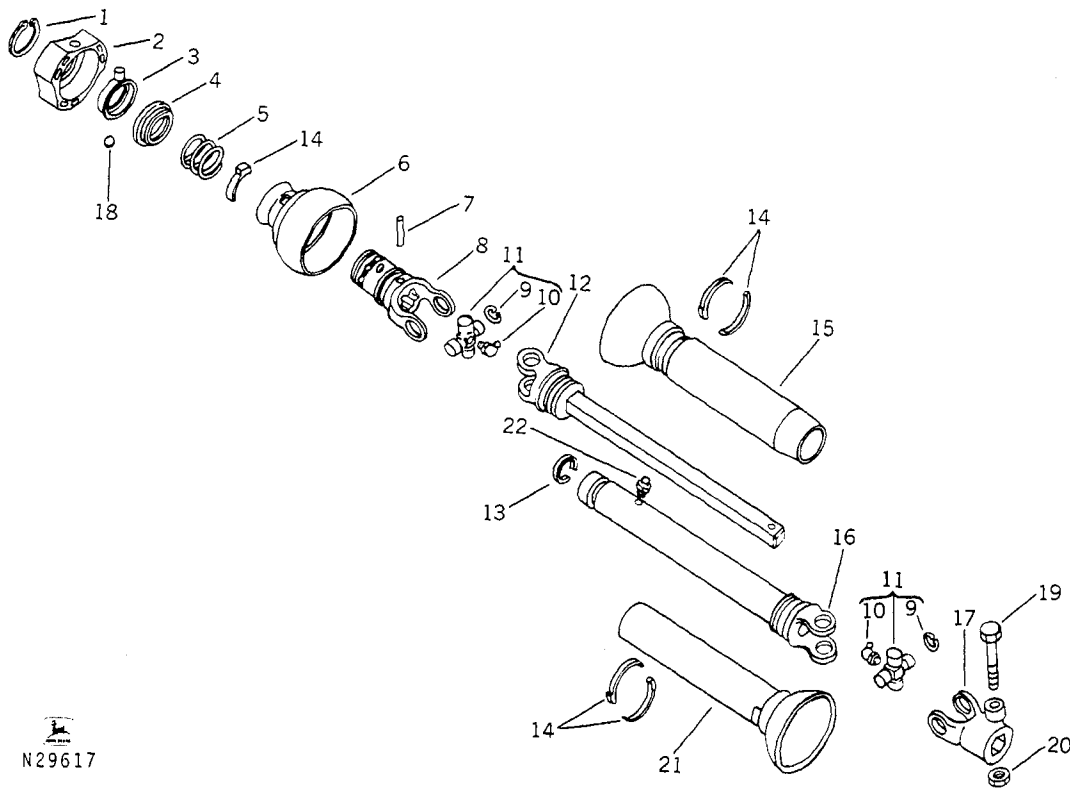

Fig. 9-Removing Nylon Bearing

## INSPECTION AND REPAIR



1—Snap Ring  
2—Push Collar  
3—Push-Button Latch  
4—Collar Retainer  
5—Spring  
6—Closure Shield  
7—Spring Pin, 1/4" x 2"

8—Push-Button Yoke  
9—Snap Ring, 2 used  
10—Grease Fitting, 2 used  
11—Spider and Bearing Assembly,  
2 used  
12—Yoke and Shaft  
13—Bearing  
14—Bearing, 9 used

15—Front Shield  
16—Yoke and Tube  
17—Yoke  
18—Steel Ball, 3 used  
19—Cap Screw  
20—Nut  
21—Rear Shield  
22—Grease Fitting

Fig. 10-Powershaft

Check the spider and bearing assemblies (11, Fig. 10) for wear. Replace if defects are found.

Check the yoke tube (16) and yoke shaft (12) for straightness. Replace if defects are found.

Check the compression spring (5) for cracks or rust. Replace if defects are found.

Check the nylon bearings (13, 14) for wear. Replace if defects are found.

**<https://www.ebooklibonline.com>**

Hello dear friend!

Thank you very much for reading.

Enter the link into your browser.

The full manual is available for immediate download.

**<https://www.ebooklibonline.com>**