

JOHN DEERE
AG & TURF DIVISION

AutoConnect™ Mid-Mount Mower
54D and 60D

OMLVU25573 A2

OPERATOR'S MANUAL



JOHN DEERE

Original Instruction

All information, illustrations and specifications in this manual are based on the latest information at the time of publication. The right is reserved to make changes at any time without notice.

COPYRIGHT© 2012

Deere & Co.

John Deere Ag & Turf Division

All rights reserved

Previous Editions

COPYRIGHT©

North American Version

Litho in U.S.A.

Introduction

Table of Contents

Introduction.....	1
Product Identification.....	1
Safety Labels.....	2
Safety.....	4
Assembly.....	6
Installing.....	10
Removing.....	12
Operating.....	13
Service.....	17
Troubleshooting.....	21
Specifications.....	22
Getting Quality Service.....	22

Introduction

Using Your Operator's Manual

Read this entire operator's manual, especially the safety information, before operating.

This manual is an important part of your machine. Keep all manuals in a convenient location so they can be accessed easily.

Use the safety and operating information in the attachment operator's manual, along with the machine operator's manual, to operate and service the attachment safely and correctly.

If your attachment manual has a section called Preparing the Machine, it means that you will have to do something to your tractor or vehicle before you can install the attachment. The Assembly and Installation sections of this manual provide information to assemble and install the attachment to your tractor or vehicle. Use the Service section to make any needed adjustments and routine service to your attachment.

If you have any questions or concerns with the assembly, installation, or operation of this attachment, see your local John Deere dealer or call the John Deere Customer Contact Center at 1-800-537-8233 for assistance.

Warranty information on this John Deere attachment can be found in the warranty that came with your John Deere tractor or vehicle.

Product Identification

Product Compatibility

The 54D and 60D AutoConnect mowers are designed for use with compact utility tractor models 1023E and 1026R.

Before installing the mower, the following equipment must be installed on the machine. See your John Deere dealer.

- Mower Lift Kit (Mechanical or Hydraulic)
- Mower Drive Kit (Standard or AutoConnect™)

Record Identification Numbers

AutoConnect™ Mid-Mount Mower

54D Serial No. (010001 -)

60D Serial No. (010001 -)

If you need to contact an Authorized Service Center for information on servicing, always provide the product model and serial number.

You will need to locate the model and serial number for the mower and record the information in the spaces provided below.

DATE OF PURCHASE:

DEALER NAME:

DEALER PHONE:

PRODUCT SERIAL NUMBER:

Safety Labels

Safety Labels

Safety Label Location - 54D AutoConnect Mower

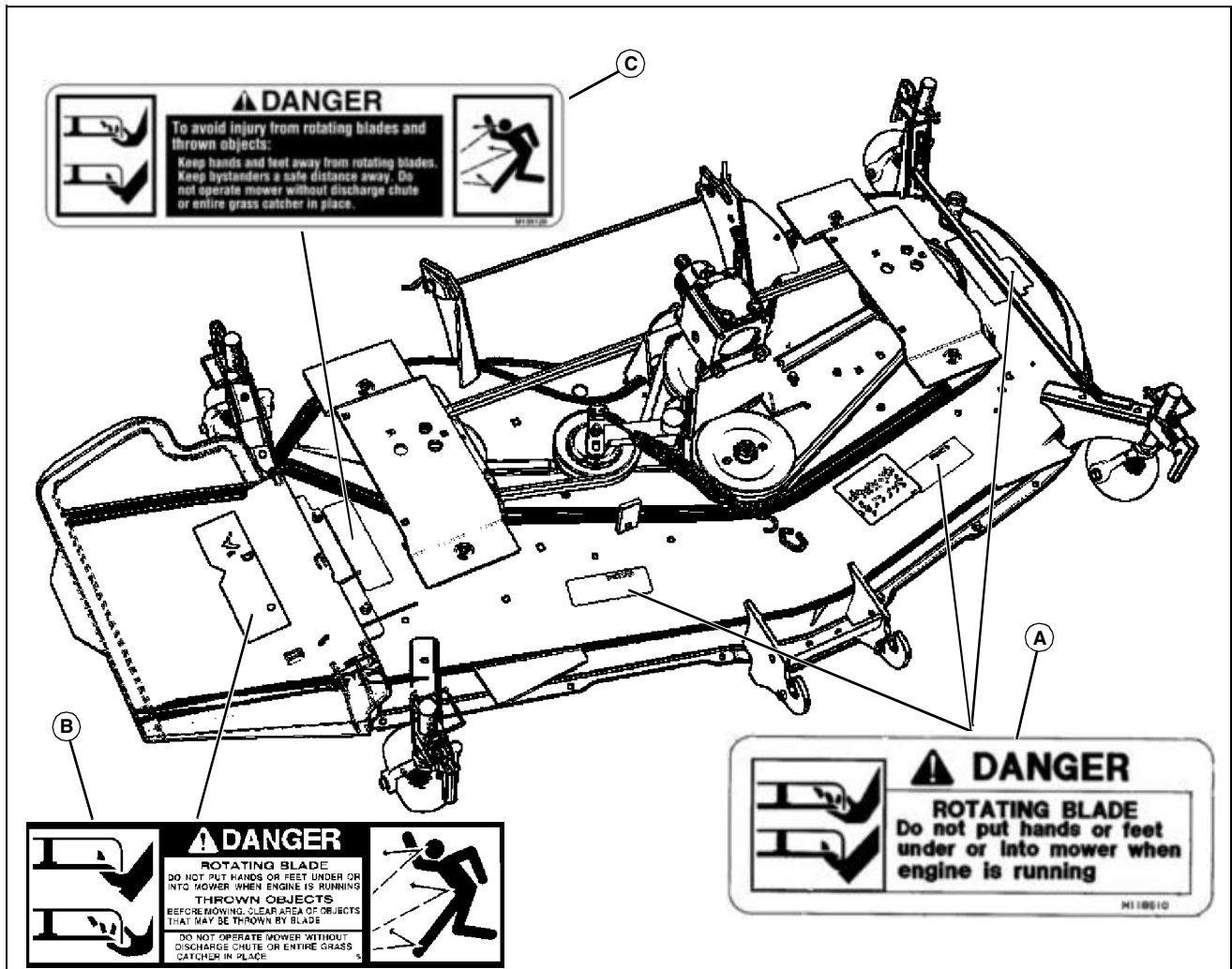

MX47182

Picture Note: Use label number listed in table below to locate complete text of safety label message following this illustration.

- A- Danger - M118610
- B- Danger - M89504
- C- Danger - M139128

<https://www.ebooklibonline.com>

Hello dear friend!

Thank you very much for reading.

Enter the link into your browser.

The full manual is available for immediate download.

<https://www.ebooklibonline.com>

Safety Labels

Safety Label Location - 60D AutoConnect Mower

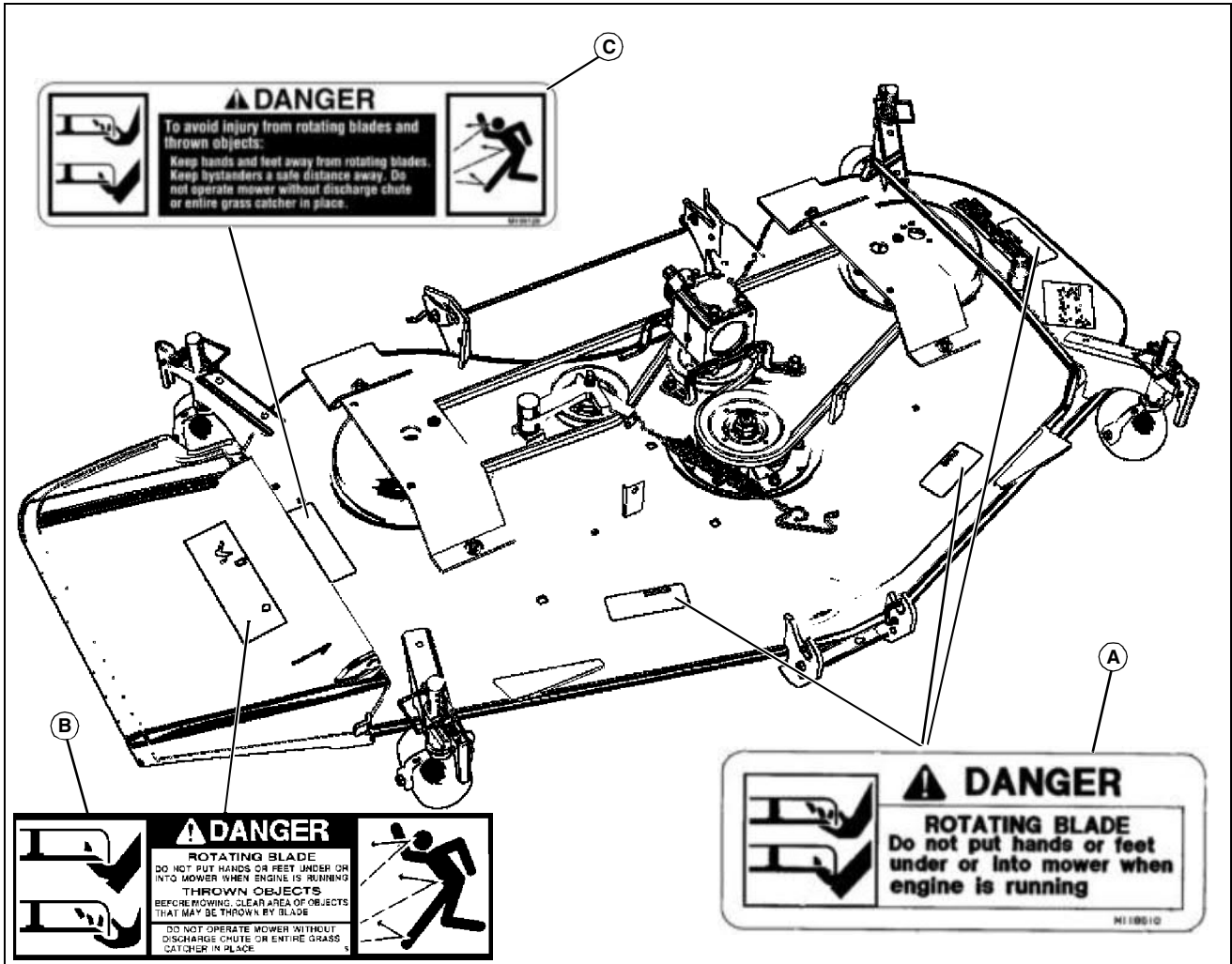

MX47181

Picture Note: Use label number listed in table below to locate complete text of safety label message following this illustration.

- A- Danger - M118610
- B- Danger - M89504
- C- Danger - M139128

DANGER - M89504

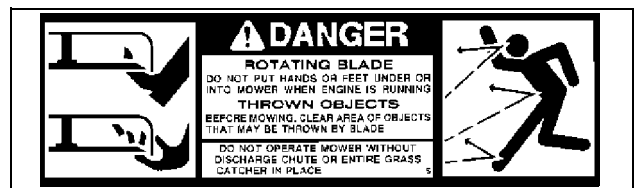

M89504

ROTATING BLADE

- Do not put hands or feet under or into mower when engine is running.

THROWN OBJECTS

- Before mowing, clear area of objects that may be thrown by blade.
- Do not operate mower without discharge chute or entire grass catcher in place.



Understanding The Machine Safety Labels

The machine safety labels shown in this section are placed in important areas on your machine to draw attention to potential safety hazards.

On your machine safety labels, the words DANGER, WARNING, and CAUTION are used with this safety-alert symbol. DANGER identifies the most serious hazards.

The operator's manual also explains any potential safety hazards whenever necessary in special safety messages that are identified with the word, CAUTION, and the safety-alert symbol.

Safety

DANGER M139128



M139128

To avoid injury from rotating blades and thrown objects:

- Keep hands and feet away from rotating blades.
- Keep bystanders a safe distance away. Do not operate mower without discharge chute or entire grass catcher in place.

DANGER - M118610



M118610

ROTATING BLADE

- Do not put hands or feet under or into mower when engine is running.

Safety

Read Safety in Machine Operator's Manual

Read the general safety operating precautions in your machine operator's manual for additional safety information.

Operator Training Required

- Read the operator's manual and other training material. If the operator or mechanic cannot read English, it is the owner's responsibility to explain this material to them. This publication is available in other languages.
- Become familiar with the safe operation of the equipment, operator controls, and safety signs.
- All operators and mechanics should be trained. The owner of the machine is responsible for training the users.
- Never let children or untrained people operate or service the equipment. Local regulations may restrict the age of the operator.
- The owner/user can prevent and is responsible for accidents or injuries occurring to themselves, other people, or property.
- Operate the machine in an open, unobstructed area under the direction of an experienced operator.

Preparation

- Evaluate the terrain to determine what accessories and attachments are needed to properly and safely perform the job. Only use accessories and attachments approved by the manufacturer.
- Wear appropriate clothing including hard hat, safety glasses and hearing protection. Long hair, loose clothing or jewelry may get tangled in moving parts.
- Inspect the area where the equipment is to be used and remove all objects such as rocks, toys and wire which can be thrown by the machine.
- Use extra care when handling gasoline and other fuels. They are flammable and vapors are explosive.
 - a. Use only an approved container.
 - b. Never remove gas cap or add fuel when engine is running. Do not smoke.
 - c. Never refuel or drain the machine indoors.
- Check that the operator's presence controls, safety switches and shields are attached and functioning properly. Do not operate unless they are functioning properly.

Operating Safely

- Never run an engine in an enclosed area where dangerous carbon monoxide fumes can collect.
- Only operate in good light, keeping away from holes and hidden hazards.
- Be sure all drives are in neutral and parking brake is engaged before starting engine. Only start engine from the operator's position. Use seat belts if provided.
- Slow down and use extra care on hillsides. Be sure to travel in the recommended direction on hillsides. For this machine, drive up and down hillsides, not across. Turf conditions can affect the machine's stability. Use caution while operating near drop-offs.
- Slow down and use caution when making turns and when changing directions on slopes.
- Never raise deck with the blades running.

Safety

- Never operate with the PTO shield, or other guards, not securely in place. Be sure all interlocks are attached, adjusted properly, and functioning properly.
- Never operate with the discharge deflector raised, removed or altered, unless using a grasscatcher. Do not operate mower without discharge chute or entire grasscatcher in place.
- Do not change the engine governor setting or overspeed the engine. Operating the engine at excessive speed can increase the hazard of personal injury.
- Stop on level ground, lower implements, disengage drives, engage parking brake, and shut off engine before leaving the operator's position for any reason including emptying the grasscatchers or unclogging the chute.
- Stop equipment and inspect blades after striking objects or if an abnormal vibration occurs. Make necessary repairs before resuming operations.
- Keep hands and feet away from the cutting units.
- Look behind and down before backing up to be sure of a clear path.
- Never carry passengers and keep pets and bystanders away.
- Slow down and use caution when making turns and crossing roads and sidewalks. Stop blades if not mowing. Watch for traffic when operating near or crossing roadways.
- Be aware of the mower discharge direction and do not point it at anyone.
- Do not operate the machine while under the influence of alcohol or drugs.
- Use care when loading or unloading the machine into or off of a trailer or truck.
- Use care when approaching blind corners, shrubs, trees, or other objects that may obscure vision.
- Inspect machine before you operate. Be sure hardware is tight. Repair or replace damaged, badly worn, or missing parts. Be sure guards and shields are in good condition and fastened in place. Make any necessary adjustments before you operate.
- Before using, always visually inspect to see that the blades, blade bolts and the mower assembly are not worn and damaged. Replace worn and damaged blades and bolts in sets to preserve balance.
- Keep safety labels visible when installing accessories and attachments.
- Do not wear radio or music headphones. Safe service and operation require your full attention.
- When machine is left unattended, stored, or parked, lower the mower deck unless a positive mechanical lock is used.

Parking Safely

1. Stop machine on a level surface, not on a slope.
2. Disengage PTO and stop attachments.
3. Lower attachments to the ground.
4. Lock park brake.
5. Stop engine.
6. Remove key.
7. Wait for engine and all moving parts to stop before you leave the operator's station.
8. Close fuel shut off valve before servicing the fuel system, if your machine is equipped.
9. Disconnect the battery ground cable before making repairs to electrical

system or doing any welding.

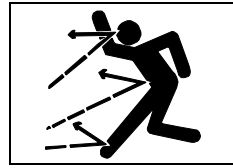

Checking Mowing Area

- Clear mowing area of objects that might be thrown. Keep people and pets out of mowing area.
- Low-hanging branches and similar obstacles can injure the operator or interfere with mowing operation. Before mowing, identify potential obstacles such as low-hanging branches, and trim or remove those obstacles.
- Study mowing area. Set up a safe mowing pattern. Do not mow where traction or stability is doubtful.
- Test drive area with mower lowered but not running. Slow down when you travel over rough ground.

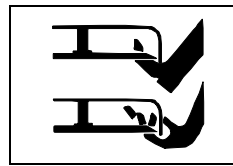

Rotating Blades are Dangerous

HELP PREVENT SERIOUS OR FATAL ACCIDENTS:

- Rotating blades can cut off arms and legs, and throw objects. Failure to observe safety instructions could result in serious injury or death.
- Keep hands, feet and clothing away from mower deck when engine is running.
- Be alert at all times, drive forward carefully. People, especially children can move quickly into the mowing area before you know it.
- Do not mow in reverse.
- Shut off blades when you are not mowing.
- Park machine safely before leaving the operator station for any reason including emptying the catchers or unplugging the chute.

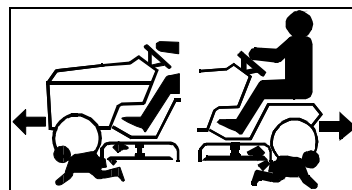

Protect Children

- Death or serious injury can occur when young children associate having fun with a lawn mowing machine simply because someone has given them a ride on a machine.
- Children are attracted to lawn mowing machines and mowing activities. They don't understand the dangers of rotating blades or the fact that the operator is unaware of their presence.
- Children who have been given rides in the past may suddenly appear in the mowing area for another ride and be run over or backed over by the machine.
- Tragic accidents with children can occur if the operator is not alert to the presence of children, especially when a child approaches a machine from behind. Before and while backing up, stop mower blades and look down and behind the machine carefully, especially for children.
- Never carry children on a machine or attachment, even with the blades off. Do not tow children in a cart or trailer. They can fall off and be seriously injured or interfere with safe machine operation.
- Never use the machine as a recreational vehicle or to entertain children.
- Never allow children or an untrained person operate the machine. Instruct all operators not to give children a ride on the machine or in an attachment.
- Keep children indoors, out of the mowing area, and in the watchful eye of a responsible adult, other than the operator, when a mower is being

Safety

operated.

- Stay alert to the presence of children. Never assume that children will remain where you last saw them. Turn the machine off if a child enters the work area.
- Use extreme care when approaching blind corners, shrubs, trees, or other objects that may block your view of a child.



Stay Clear of Rotating Drivelines

Entanglement in rotating driveline can cause serious injury or death.

- Wear close fitting clothing.
- Stop the engine and be sure PTO driveline is stopped before getting near it.

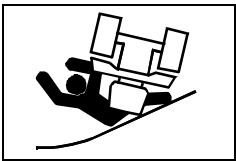

Avoid Tipping

Slopes are a major factor related to loss-of-control and tip-over accidents, which can result in severe injury or death. Operation on all slopes requires extra caution.

- Be aware that mechanical front wheel drive (MFWD) can improve access to dangerously sloped terrain, thereby increasing the possibility of a tipover.

- Drive up and down a hill - not across.
- Watch for holes, ruts, bumps, rocks, or other hidden objects. Uneven terrain could overturn the machine. Tall grass can hide obstacles.
- Do not operate machine on wet grass. Tires may lose traction. Tires may lose traction on slopes even though the brakes are functioning properly.
- Choose a low ground speed so you will not have to stop or shift while on a slope.
- Always keep the machine in gear when going down slopes. Do not shift to neutral and coast downhill.
- Avoid starting, stopping or turning on a slope. If the tires lose traction, disengage the blades and proceed slowly, straight down the slope.
- Keep all movement on slopes slow and gradual. Do not make sudden changes in speed or direction, which could cause the machine to roll over.
- Do not operate machine near drop-offs, ditches, embankments, or bodies of water. The machine could suddenly roll over if a wheel goes over the edge or the edge caves in. Leave a safety area between the machine and any hazard.
- Danger of tipping is increased greatly with tires in narrow tread setting and driving at high speed.
- Follow the manufacturer's recommendations for wheel weights or counterweights for added stability when operating on slopes or using front or rear mounted attachments. Remove weights when not required.

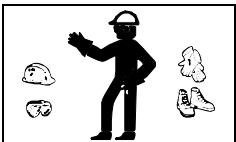

Wear Appropriate Clothing

Always wear safety goggles, or safety glasses with side shields, and a hard hat when operating the machine.

- Wear close fitting clothing and safety

equipment appropriate for the job.

- While operating this machine, always wear substantial footwear and long trousers. Do not operate the equipment when barefoot or wearing open sandals.
- Wear a suitable protective device such as earplugs. Loud noise can cause impairment or loss of hearing.



Maintenance and Storage

- Never operate machine in a closed area where dangerous carbon monoxide fumes can collect.
- Disengage drives, lower implement, lock parking brake, stop engine and remove key or disconnect spark plug (for gas engines). Wait for all movement to stop before adjusting, cleaning or repairing.
- Clean grass and debris from cutting units, drives, mufflers, and engine to help prevent fires. Clean up oil or fuel spillage.
- Let engine cool before storing and do not store near flame.
- Shut off fuel while storing or transporting. Do not store fuel near flames or drain indoors.
- Park machine on level ground. Never allow untrained personnel to service machine. Understand service procedure before doing work.
- Use jack stands or lock service latches to support components when required. Securely support any machine elements that must be raised for service work.
- Before servicing machine or attachment, carefully release pressure from any components with stored energy, such as hydraulic components or springs.
- Release hydraulic pressure by lowering attachment or cutting units to the ground or to a mechanical stop and move hydraulic control levers back and forth.
- Disconnect battery or remove spark plug (for gas engines) before making any repairs. Disconnect the negative terminal first and the positive last. Reconnect positive first and negative last.
- Use care when checking blades. Wrap the blades or wear gloves, and use caution when servicing them. Only replace blades. Never straighten or weld them.
- Keep hands, feet, clothing, jewelry and long hair away from moving parts. If possible, do not make adjustments with the engine running.
- Charge batteries in an open well ventilated area, away from spark and flames. Unplug charger before connecting or disconnecting from battery. Wear protective clothing and use insulated tools.
- Keep all parts in good working condition and all hardware tightened. Replace all worn or damaged decals.
- Check grasscatcher components and the discharge guard frequently and replace with manufacturer's recommended parts, when necessary. Grasscatcher components are subject to wear, damage, and deterioration which could expose moving parts or allow objects to be thrown.
- Keep all nuts and bolts tight, especially blade attachment bolts, to be sure the equipment is in safe working condition.
- Check brake operation frequently. Adjust and service as required.
- On multi-bladed machines, take care as rotating one blade can cause other blades to rotate.



Suggest:

If the above button click is invalid.

Please download this document

first, and then click the above link

to download the complete manual.

Thank you so much for reading

Assembly

Assembly

Parts in Kit

54D Mower Deck

Qty.	Description
1	54D Mower Deck Assembly
4	Gage Wheel
4	Spring Pin
1	Gearbox Assembly
4	Bolt, M10x25
1	Discharge Chute Assembly
2	Bolt, Carriage Head, M8x16
2	Locknut, M8
1	Front Draft Link Assembly
1	Spring, Draft Link

60D Mower Deck

Qty.	Description
1	60D Mower Deck Assembly
4	Gage Wheel
4	Spring Pin
1	Gearbox Assembly
4	Bolt, M10x25
1	Discharge Chute
1	Rod, Chute Pivot
1	Spring, Chute Tension
1	Roll Pin
1	Front Draft Link Assembly
1	Spring, Draft Link

Assemble Mower

Before installing the mower, the following equipment must be installed on the machine. See your John Deere dealer.

- Mower Lift Kit (Mechanical or Hydraulic)
- Mower Driveshaft Kit (Standard or AutoConnect™)

Install Wheels



CAUTION: Avoid injury! Machine component or attachment is heavy. Use a safe lifting device with correct load capacity rating to lift, install or remove component or attachment.

1. Remove mower from crate using chain hoist or other suitable device.

NOTE: After wheels are installed, it may be necessary to lock wheels by pressing downward on handles (A) until they are perpendicular to ground. However, wheels must be in the unlocked position before installing mower on tractor.

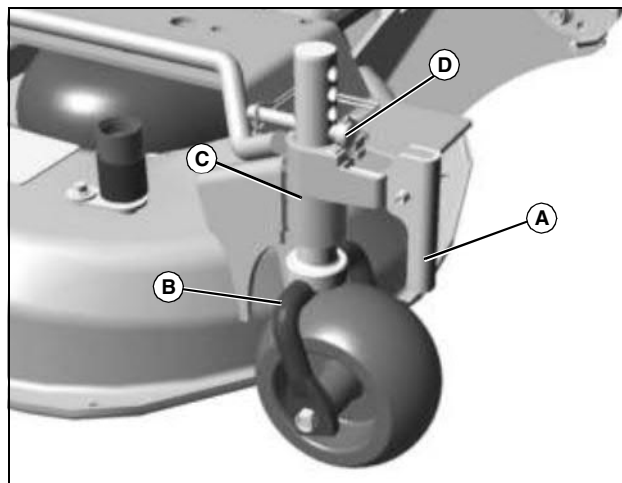

MX47069

2. Install wheels (B) by sliding wheel shaft up through wheel bracket (C).
3. Install spring pin (D) in each wheel shaft.

<https://www.ebooklibonline.com>

Hello dear friend!

Thank you very much for reading.

Enter the link into your browser.

The full manual is available for immediate download.

<https://www.ebooklibonline.com>