



Service Repair Manual

Models

983B TRACK LOADER

[Previous Screen](#)

Product: TRACK LOADER

Model: 983B TRACK LOADER 58X

Configuration: 983B TRACK LOADER 58X00001-UP (MACHINE) POWERED BY 3406 ENGINE

Disassembly and Assembly SUPPLEMENT FOR 3406 SCROLL FUEL SYSTEM

Media Number -SEN2858-00

Publication Date -01/09/1982

Date Updated -25/10/2002

Fuel Valve Adapters

SMCS - 1106-15; 1106-16

Remove Fuel Valve Adapters

Tools Needed		A	B
FT1322	Lever Assembly	1	
5P125	Wrench		1

START BY:

a) remove direct injection nozzles

1. Drain the coolant from the radiator.



2. Use tool (A) to make a separation of the rockershaft from the push rods and remove the push rods.



3. Put rockers (1) in position as shown.

4. Remove bridges (2) from the lifters.

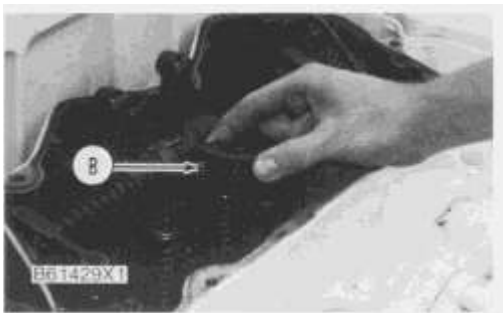

5. Install tool (B) on the adapters and remove them from the cylinder head.

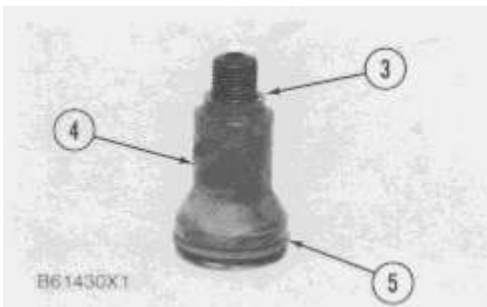

6. Remove washers (3) and seals (5) from adapters (4).

Install Fuel Valve Adapters

Tools Needed		A	B
5P125	Wrench	1	
FT1322	Lever Assembly		1

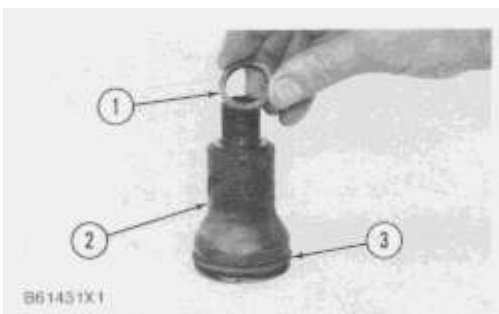

1. Inspect seals (3) for damage or wear and make a replacement if necessary.

2. Install washers (1) and seals (3) on adapters (2).

<https://www.ebooklibonline.com>

Hello dear friend!

Thank you very much for reading.

Enter the link into your browser.

The full manual is available for immediate download.

<https://www.ebooklibonline.com>



3. Put liquid soap in the bores of the cylinder head and the seals.
4. Put 5P3931 Anti-Seize on the threads of adapters (2) and install the adapters in the cylinder head.
5. Use tool (A) and tighten the adapters to a torque of $205 \pm 14 \text{ N}\cdot\text{m}$ ($154 \pm 10 \text{ lb}\cdot\text{ft}$).

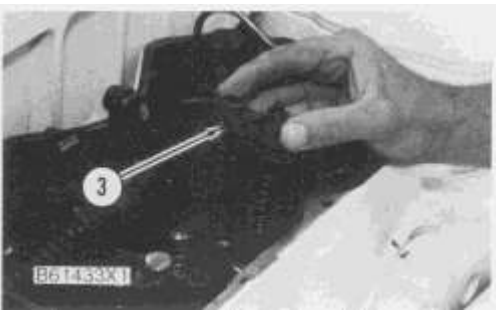

6. Put bridges (3) into position on the lifters as shown.



7. Use tool (B) to move the rocker shaft and install push rods (4) as shown.
8. Fill the radiator with coolant. For the correct level see MAINTENANCE GUIDE.

END BY:

a) install direct injection nozzles

[Previous Screen](#)

Product: TRACK LOADER

Model: 983B TRACK LOADER 58X

Configuration: 983B TRACK LOADER 58X00001-UP (MACHINE) POWERED BY 3406 ENGINE

Disassembly and Assembly SUPPLEMENT FOR 3406 SCROLL FUEL SYSTEM

Media Number -SEN2858-00

Publication Date -01/09/1982

Date Updated -25/10/2002

Automatic Timing Advance

SMCS - 1271-12; 1272-11; 1272-15; 1272-16

Remove Automatic Timing Advance

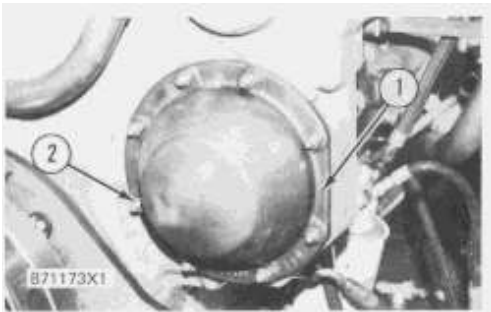

1. Remove nuts (2), cover (1) and the gasket from the timing gear cover.

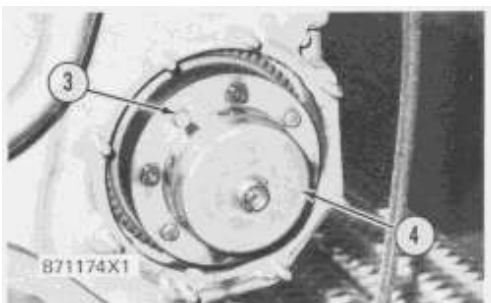

2. Remove bolts (3) and automatic timing advance (4) from the engine.

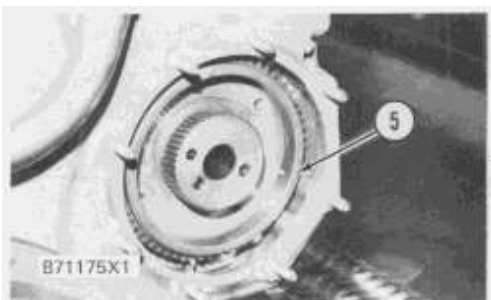

3. Remove gear (5) from the timing gears.

Install Automatic Timing Advance

1. Before the automatic timing advance is installed make sure the fuel pump and engine are in correct time. See 3406 VEHICULAR ENGINE TESTING AND ADJUSTING.

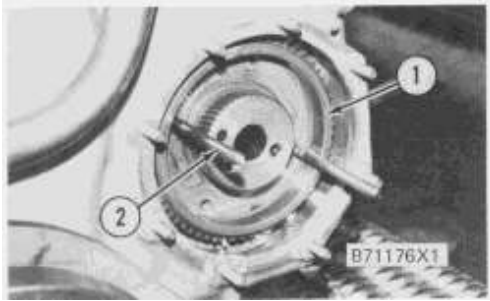

2. Put gear (1) in position in the front timing gear cover.

3. Install two 3/8" - 16 NC 6" long guide bolts (2) as shown.

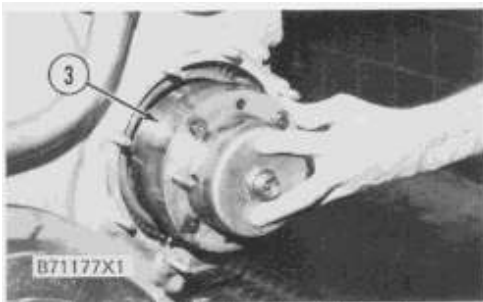

4. Install automatic timing advance (3) on the end of the fuel pump camshaft and install the four bolts that hold it. Tighten the bolts to a torque of 55 ± 7 N·m (41 ± 5 lb.ft.).

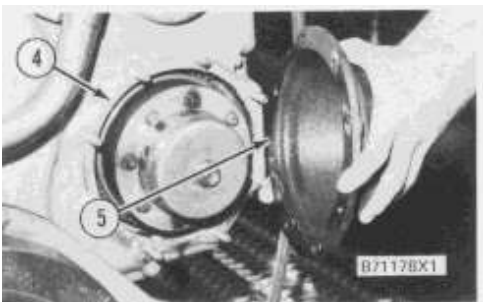

5. Install gasket (4), cover (5) and the nuts on the front timing gear cover.

Disassemble Automatic Timing Advance

START BY:

a) remove automatic timing advance

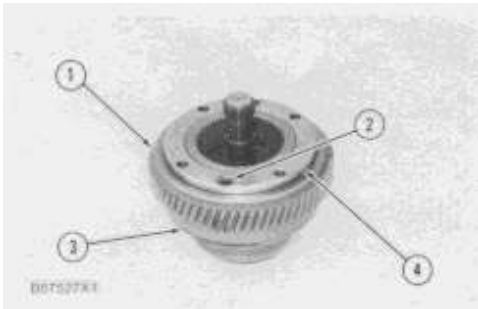

1. If necessary, remove gear (1) from the automatic timing advance.

NOTICE

Spring force is present behind carrier (4). Put downward pressure on carrier (4) when bolts (2) are removed.

2. Remove bolts (2), ring (4) and the carrier from ring (3).

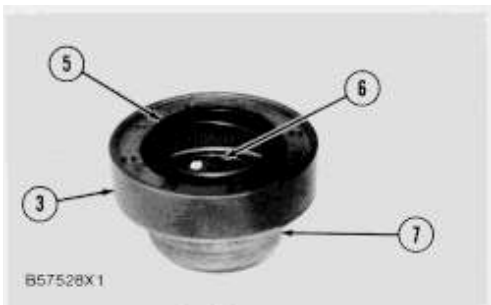

3. Remove springs (5) and (6) from retainer assembly (7).
4. Remove ring (3) from retainer assembly (7).

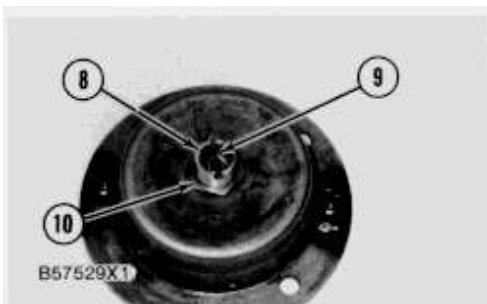

5. Remove screw (8) and setscrew (9) from the retainer assembly.
6. Remove nut (10) from screw (8).
7. Remove the nut from setscrew (9).

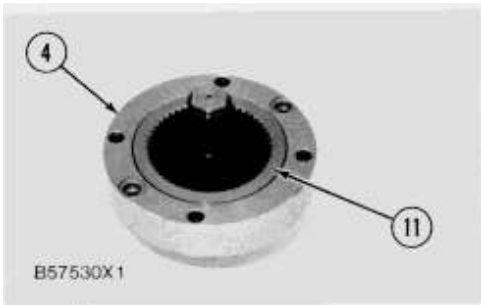

NOTE: There is a seal between ring (4) and carrier (11). Do not damage the seal when the ring is removed.

8. Carefully remove ring (4) from carrier (11).

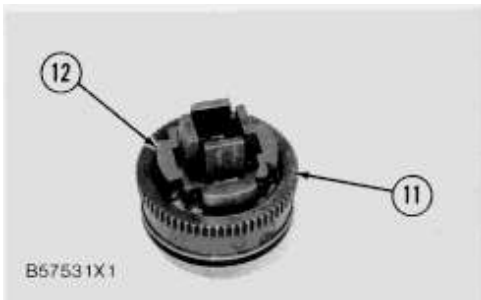

9. Remove the bolts and carrier (12) from carrier (11).

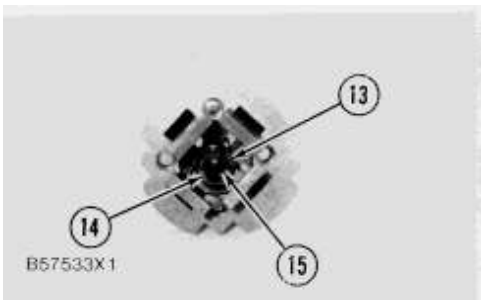

10. Remove ring (14), race (13) from spool (15) and remove spool (15) from the carrier.

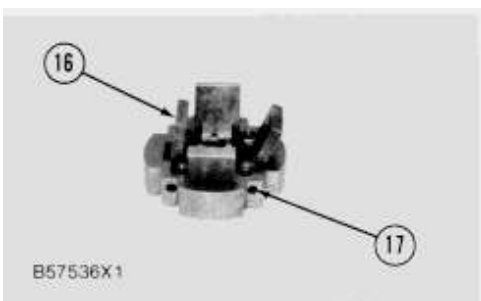

11. Remove dowels (17) and flyweights (16) from the carrier.

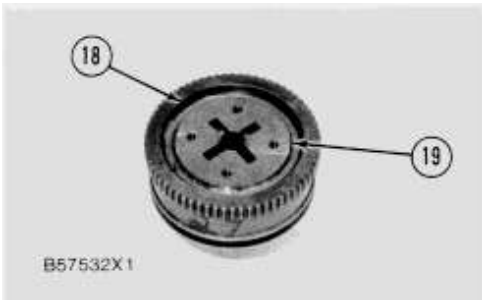

12. Remove ring (18) and carefully tap body (19) from the carrier.

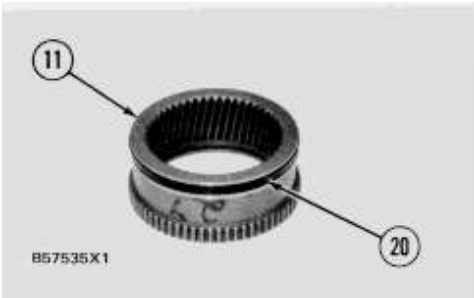

13. Remove seal (20) from carrier (11).

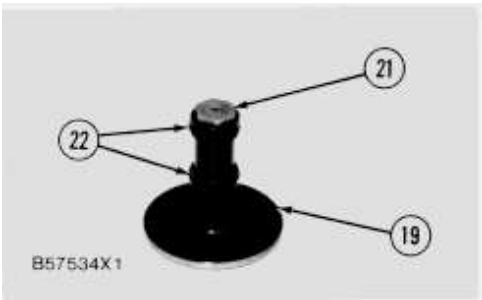

14. Remove plug (21) and seals (22) from body (19).

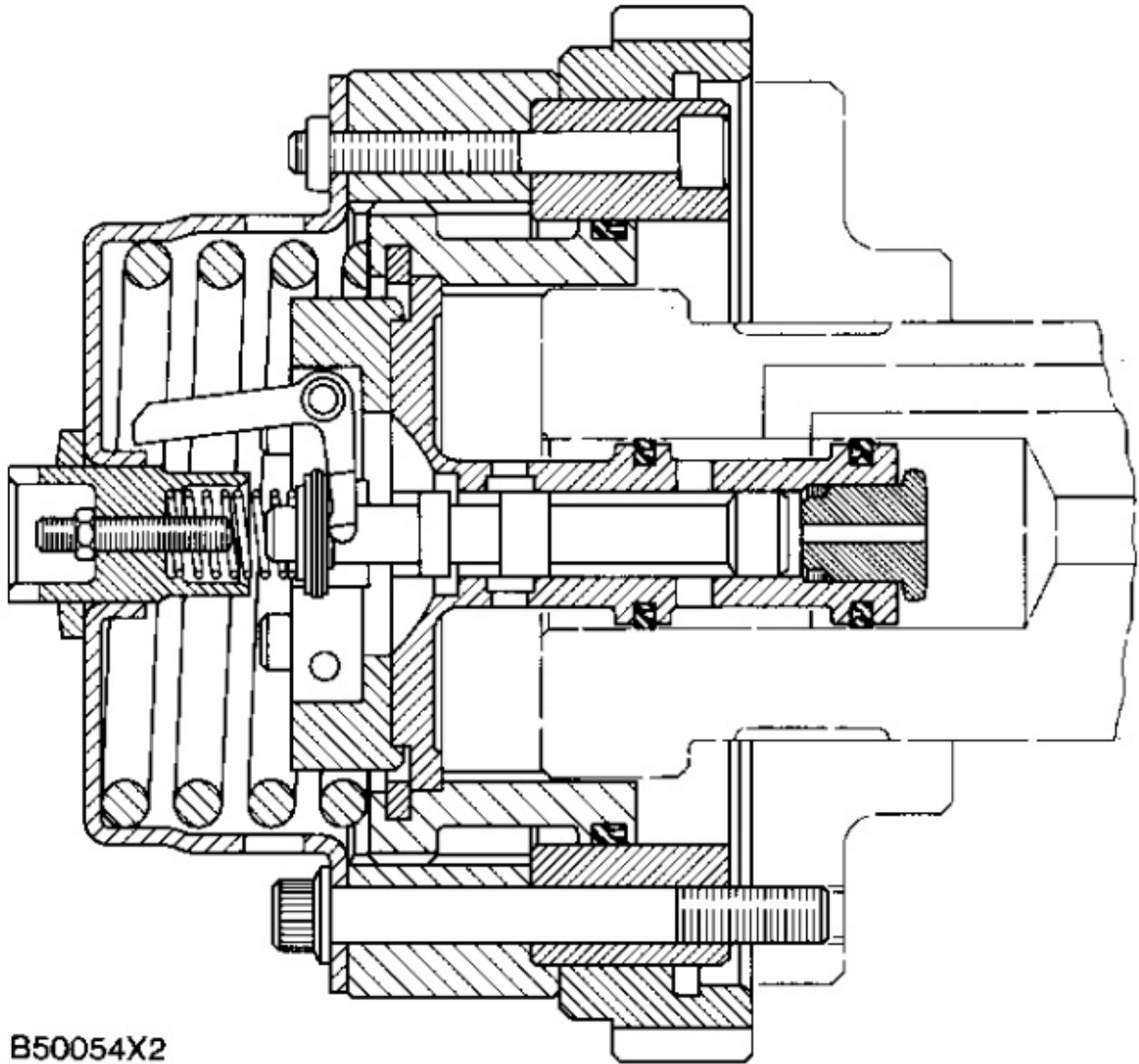

B50054X2

Assemble Automatic Timing Advance

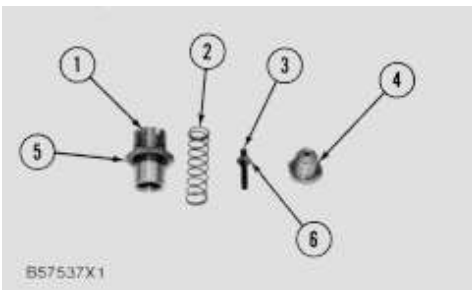

B57537X1

1. Assemble the automatic timing advance except for screw (1), nut (5), spring (2), setscrew (3), nut (6) and plug (4).

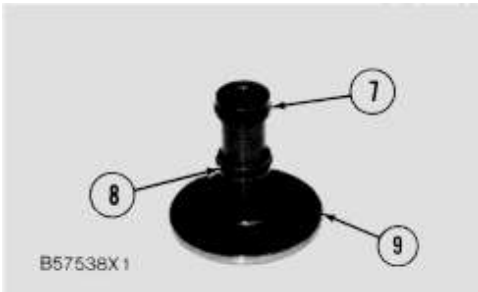

2. Install seal (7) on body (9) as shown. Put clean engine oil on the lip of the seal.

3. Install seal (8) on body (9) as shown. Put clean engine oil on the seal.



4. Install seal (10) on carrier (11) as shown. Put clean engine oil on the seal.

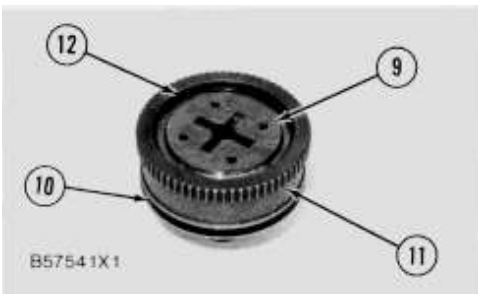

5. Put body (9) in carrier (11) and install ring (12) that holds the body in place. If necessary, use a press to install the body.

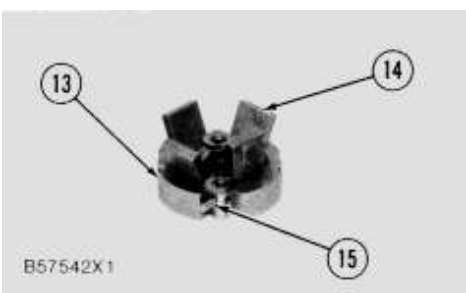

6. Put flyweights (14) in position in carrier (13) and install dowels (15) that hold the flyweights in place.

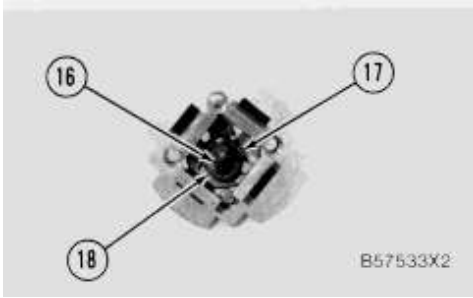

7. Put spool (16) in position in the carrier and install race (17) and ring (18) as shown.

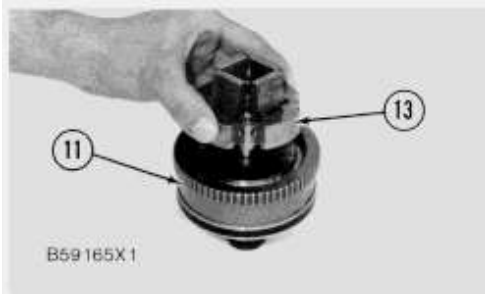

8. Put carrier (13) in position in carrier (11) and install the bolts.

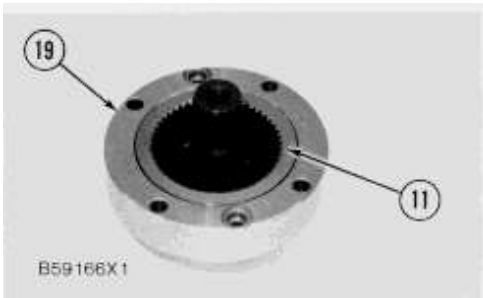

NOTICE

Do not damage the seal in carrier (11) when ring (19) is installed.

9. Put ring (19) in position on carrier (11) as shown.



10. Put spring (20) in position in retainer assembly (21) as shown.

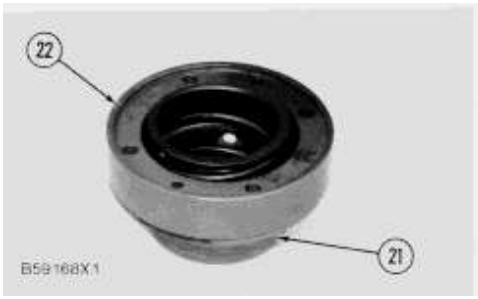

11. Install ring (22) on retainer assembly (21).

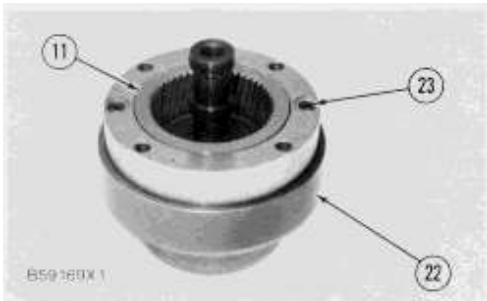

12. Put carrier (11) and the ring in position on ring (22) and the retainer. Install bolts (23) and tighten them to a torque of $12 \pm 4 \text{ N}\cdot\text{m}$ ($9 \pm 3 \text{ lb}\cdot\text{ft}$).

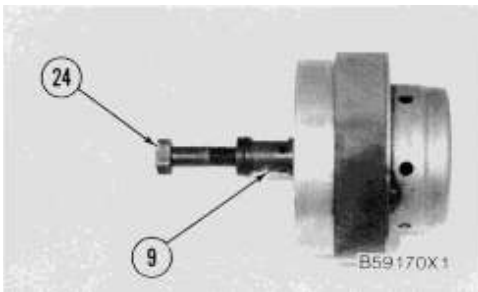

13. For field setting of the automatic timing advance follow Steps 14-20.

14. Install 3B7080 5/8"-18 NF x 2 1/2 in. drive screw (24) in body (9) to move the spool in the full advanced position.

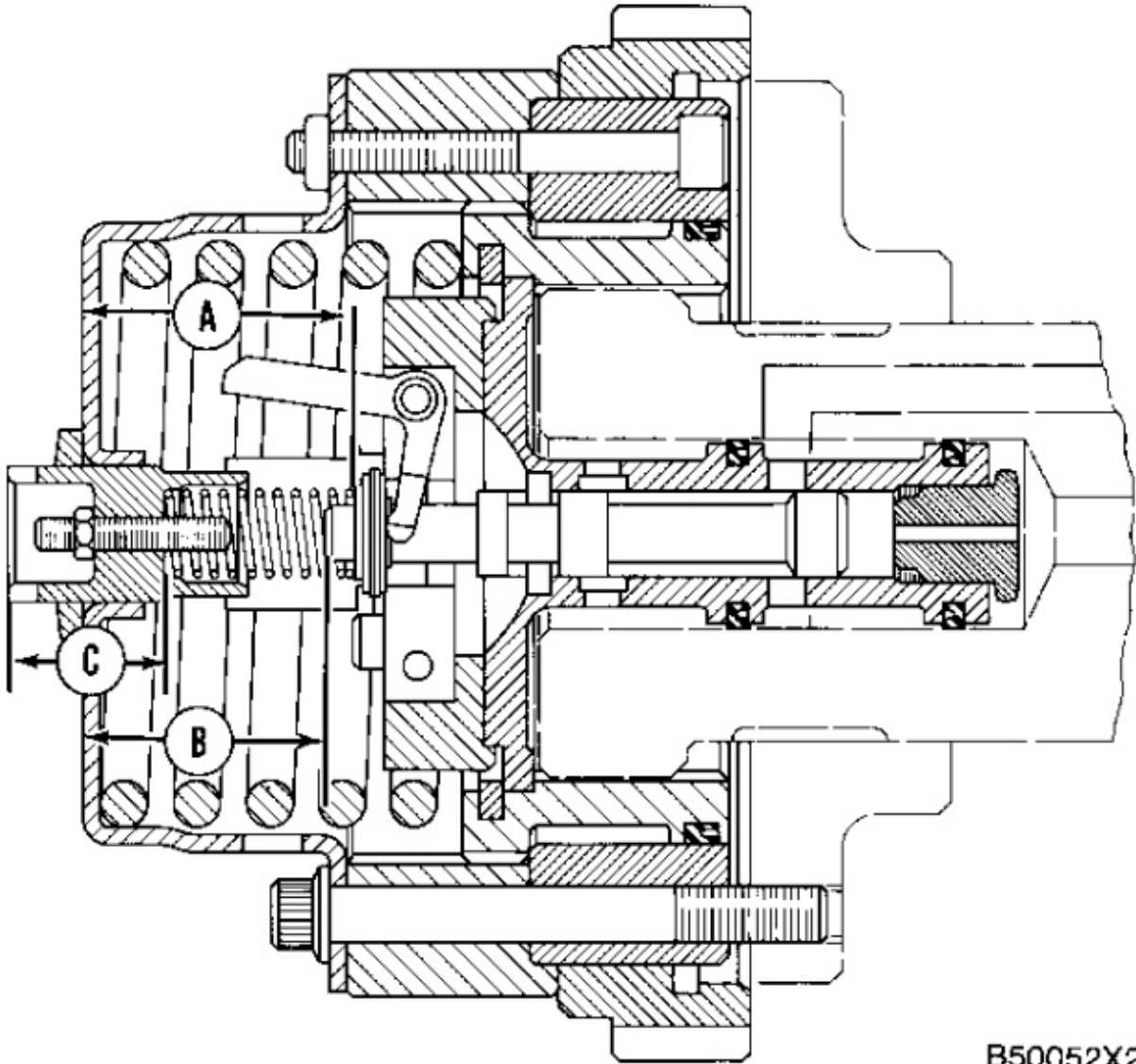

B50052X2

15. Measure the following dimensions as shown.

- a) A = Length from retainer (21) to the spring seat.
- b) B = Length from retainer (21) to the end of spool (16).
- c) C = Pocket depth of screw (1).
- d) D = Setscrew (3) length not shown.
- e) E = Free length of spring (2) not shown.

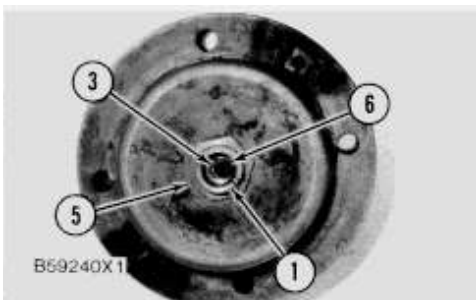

16. Install spring (2) and screw (1) in retainer (21). Make an adjustment of screw (1) to dimension F found in this formula.

$$F = E + C - A - K_1$$

K_1 = Desired spring compression

17. Install nut (5) on screw (1) and tighten it to a torque of $70 \pm 15 \text{ N}\cdot\text{m}$ ($50 \pm 11 \text{ lb}\cdot\text{ft}$).

18. Install setscrew (3) in screw (1) and make an adjustment to dimension G found in this formula.

$$G = B - D + K_2$$

K_2 = Desired spool travel for timing advance stop

19. Install nut (6) on screw (3) and tighten it to a torque of $2.25 \pm 0.25 \text{ N}\cdot\text{m}$ ($20 \pm 2 \text{ lb}\cdot\text{in}$).

20. Remove the bolt from the body and install the plug. Tighten the plug to a torque of $70 \pm 15 \text{ N}\cdot\text{m}$ ($50 \pm 11 \text{ lb}\cdot\text{ft}$).

[Previous Screen](#)

Product: TRACK LOADER

Model: 983B TRACK LOADER 58X

Configuration: 983B TRACK LOADER 58X00001-UP (MACHINE) POWERED BY 3406 ENGINE

Disassembly and Assembly SUPPLEMENT FOR 3406 SCROLL FUEL SYSTEM

Media Number -SEN2858-00

Publication Date -01/09/1982

Date Updated -25/10/2002

Fuel Injection Lines

SMCS - 1278-12

Remove And Install Fuel Injection Lines

1. Remove fuel lines (1) from the fuel injection pump housing and the cylinder head. Put protection caps on all fuel line connections to keep dirt and foreign material out of the fuel system.



If clamps (2) are not installed in their exact location, vibration can cause fuel lines (1) to break and cause possible personal injury or damage to the machine.

2. If a separation of fuel lines (1) has to be made, make sure the exact location of clamps (2) are marked for assembly purposes. Remove clamps (2) and make a separation of fuel lines (1).
3. The following steps are to install the fuel lines.
4. Connect fuel lines (1) with clamps (2). Make sure the clamps are installed back in their correct location. See 3406 SPECIFICATIONS or TESTING AND ADJUSTING.
5. Install fuel lines (1) on the fuel injection pump housing and the cylinder head. Tighten the fuel lines to a torque of 40 ± 7 N·m (30 ± 5 lb.ft.).

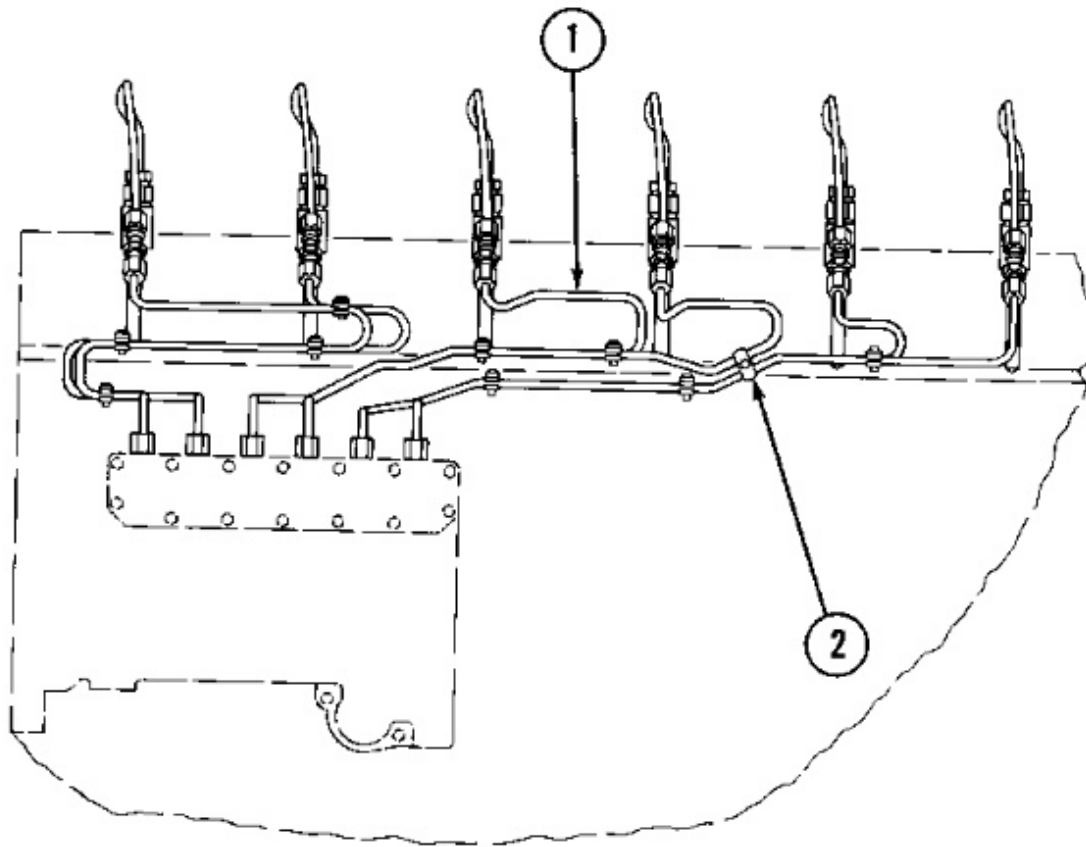

B50043X2

[Previous Screen](#)

Product: TRACK LOADER

Model: 983B TRACK LOADER 58X

Configuration: 983B TRACK LOADER 58X00001-UP (MACHINE) POWERED BY 3406 ENGINE

Disassembly and Assembly SUPPLEMENT FOR 3406 SCROLL FUEL SYSTEM

Media Number -SEN2858-00

Publication Date -01/09/1982

Date Updated -25/10/2002

Fuel Transfer Pump

SMCS - 1256-15; 1256-16

Disassemble Fuel Transfer Pump

1. Remove the fuel transfer pump from the fuel injection pump housing.

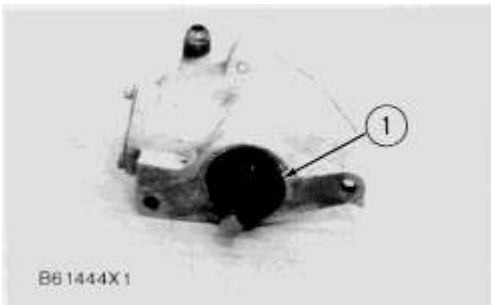

2. Remove seal (1) from the fuel transfer pump.

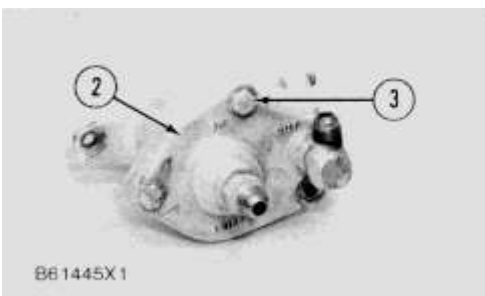

3. Remove bolts (3) and cover (2) the housing.

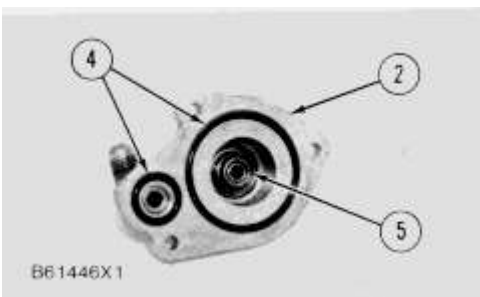

4. Remove seals (4) and valve (5) from cover (2).

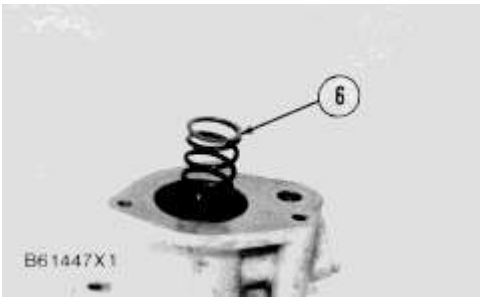

5. Remove spring (6) from the piston.

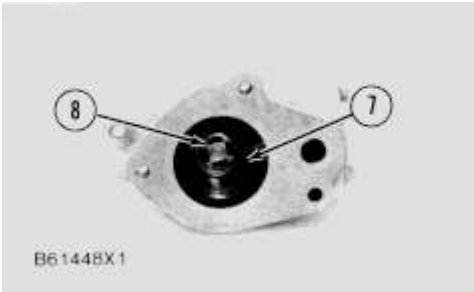

6. Remove washer (7) and valve (8) from the housing.



7. Remove piston (9) and sleeve (10) from the housing.

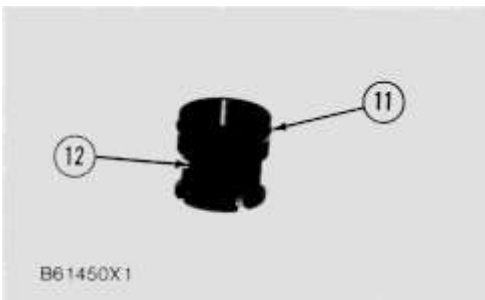

8. Remove seal (11) from sleeve (12).



9. Remove guide and tappet assembly (13) from the housing.

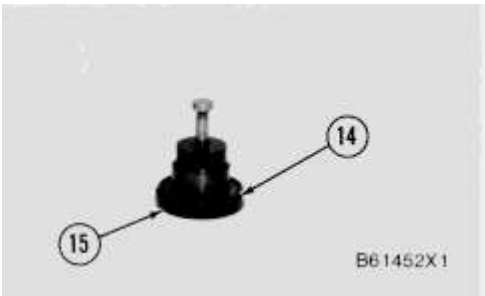

10. Remove seal (14) from guide (15).

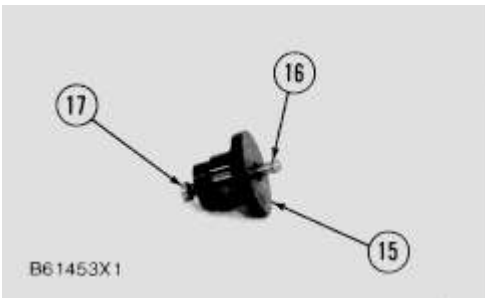

11. Remove ring (16) from tappet (17) and the tappet from guide (15).

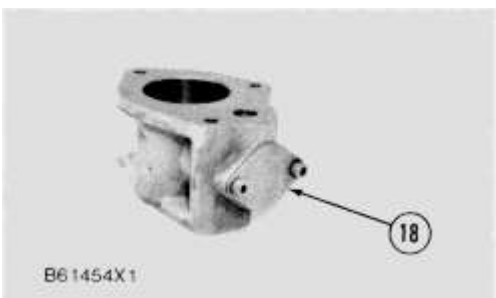

12. Remove the bolts and cover (18) from the housing.

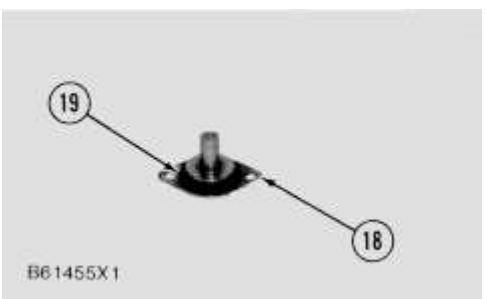

13. Remove seal (19) from cover (18).

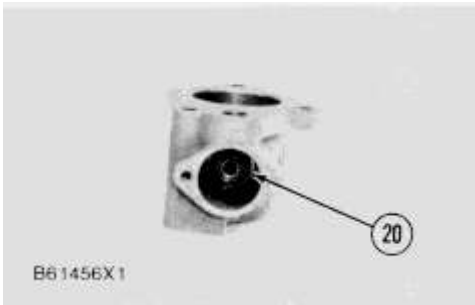

14. Remove valve (20) from the housing.

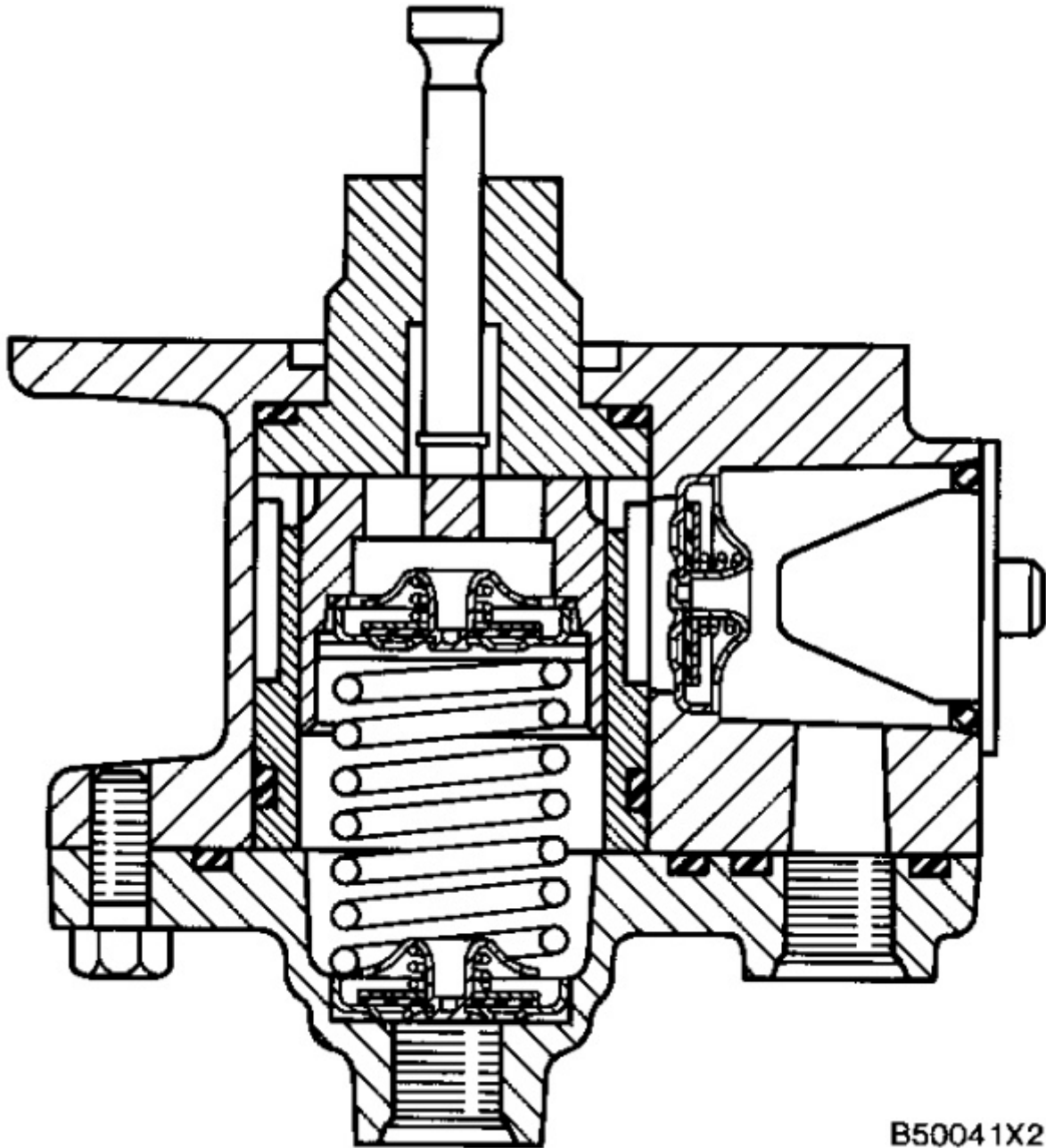

Assemble Fuel Transfer Pump

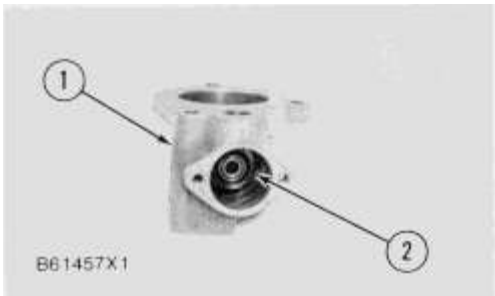

1. Install valve (2) in housing (1).

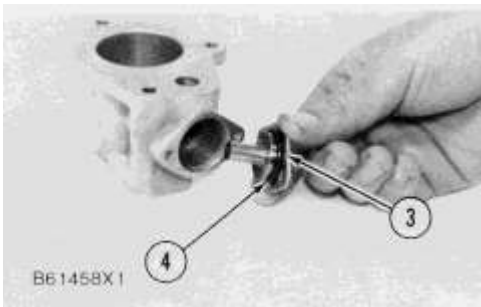

2. Put clean fuel on seal (4) and install it on cover (3).

3. Install cover (3) on the housing.

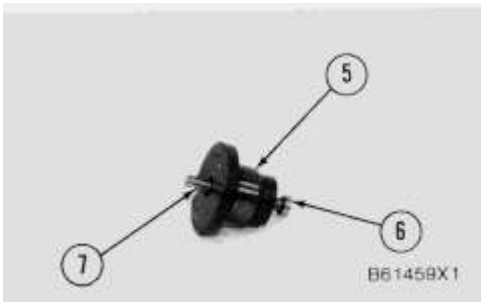

4. Install tappet (6) in guide (5). Install ring (7) on tappet (6) to hold the tappet in the guide.

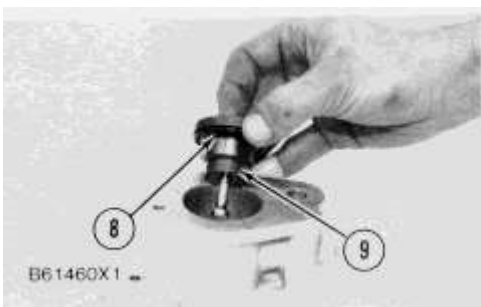

5. Put clean fuel on seal (8) and install it on guide and tappet assembly (9).

6. Install guide and tappet assembly (9) in the housing as shown.

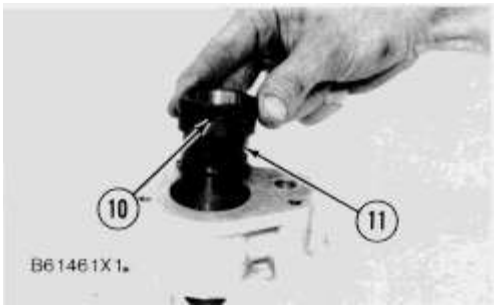

7. Put clean fuel on seal (10) and install it on sleeve (11).

8. Install sleeve (11) in the housing.

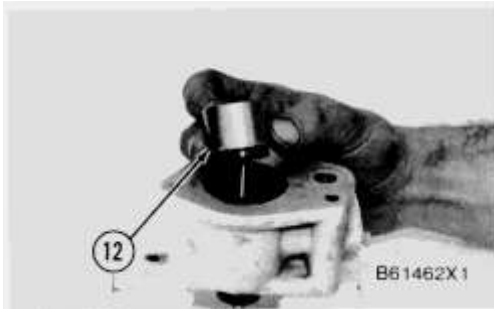

9. Install piston (12) in the housing.

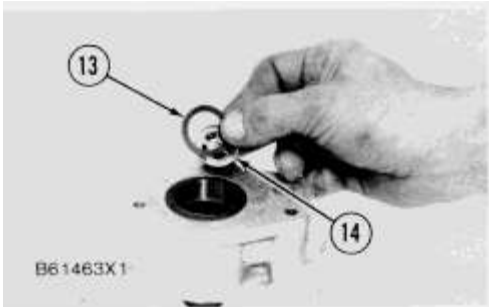

10. Install valve (14) and washer (13) in the housing as shown.



11. Install spring (15) in the piston.

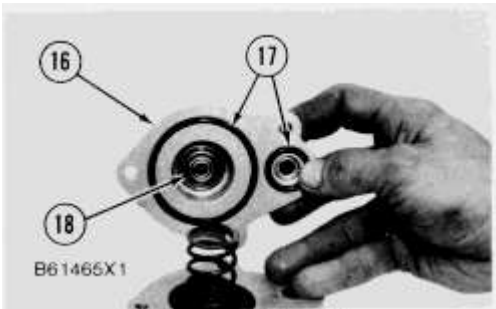

12. Install valve (18) in cover (16) as shown.

13. Put clean fuel on seals (17) and put them in position on cover (16).

14. Install cover (16) on the housing.

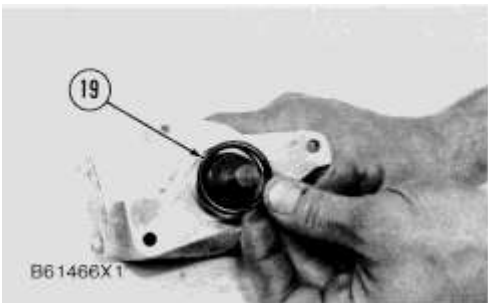

15. Put seal (19) in position on the fuel transfer pump.

16. Install the fuel transfer pump on the fuel injection pump housing.

[Previous Screen](#)

Product: TRACK LOADER

Model: 983B TRACK LOADER 58X

Configuration: 983B TRACK LOADER 58X00001-UP (MACHINE) POWERED BY 3406 ENGINE

Disassembly and Assembly SUPPLEMENT FOR 3406 SCROLL FUEL SYSTEM

Media Number -SEN2858-00

Publication Date -01/09/1982

Date Updated -25/10/2002

Governor

SMCS - 1264-15; 1264-16

Disassemble Governor

Tools Needed		A	B	C
FT1251	Pump Housing Stand	1		
1P1855	Pliers		1	
6V2163	Clamp Assembly-Spring Compressor			1

START BY:

a) remove fuel transfer pump

1. Fasten a hoist to the fuel injection pump housing and governor and remove it from the engine. The weight of the fuel injection pump housing and governor is 57 kg (125 lb.).

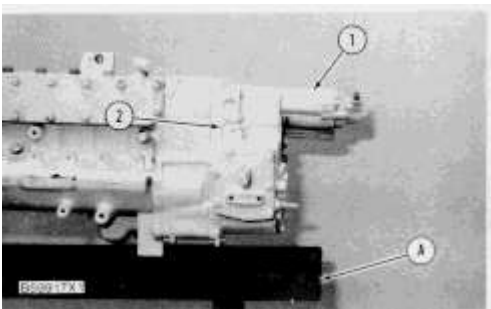

NOTE: If it is desired to only remove the governor so the fuel injection pump housing can be disassembled, do only Steps 2, 3, 4, 17, 24, 27, 28, 29, 30, 34, 36, 37 and 40.

2. Put the fuel injection pump housing and governor in position on tool (A).

3. Remove the bolts, fuel ratio control (1) and the shutoff solenoid (if equipped) from rear governor housing (2).

4. Remove the bolts, rear governor housing (2) and the gasket from the front governor housing.



Suggest:

If the above button click is invalid.

Please download this document

first, and then click the above link

to download the complete manual.

Thank you so much for reading

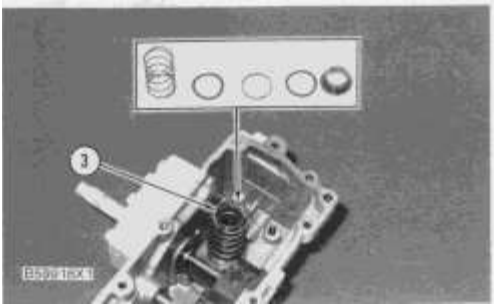

5. Remove governor spring (3), the two wave washers, one flat washer and the seat from the guide in the rear governor housing.

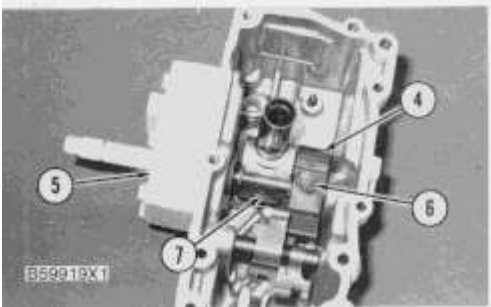

6. Remove bolt (6) that holds lever assembly (4) to the shaft assembly.

7. Remove the bolts, cover assembly (5), the gasket, the shaft assembly, lever (4) and lever (7) from the rear governor housing.

NOTE: There is a key in the (slot) groove of the shaft assembly that must be removed before the shaft assembly is removed from the rear governor housing.

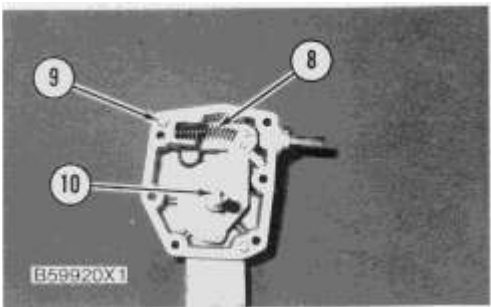

8. Remove spring (8), shaft assembly (10) and if necessary dowels (9) from the cover assembly.

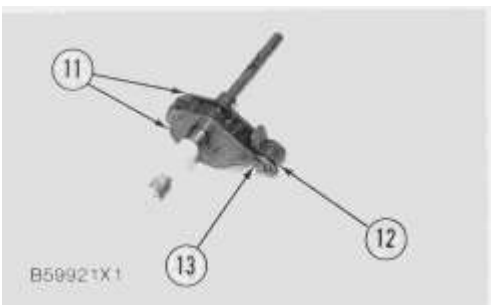

9. Remove the rings, pins (13), stop (12) and plates (11) from the shaft assembly.

<https://www.ebooklibonline.com>

Hello dear friend!

Thank you very much for reading.

Enter the link into your browser.

The full manual is available for immediate download.

<https://www.ebooklibonline.com>