



# Service Repair Manual

## **Models**

324D L and 324D LN Excavator

---

### Required Tools

Tool	Part Number	Part Description	Qty
A	1P-2420	Transmission Repair Stand	1
B	138-7573	Link Bracket	2
C	154-6181	Forcing Screw	1
D	138-7574	Link Bracket	2
	5F-7366	Forcing Screw	1
	1P-5546	Crossblock	1
	1U-9889	Crossblock	1
E	1P-0520	Driver Group	1
	6V-7888	Puller Leg	2
	1H-3112	Puller Assembly	1
	1P-5551	Adjustable Screw Assembly	1
F	1U-8846	Gasket Sealant	1

#### Start By:

- a. Remove the final drive. Refer to Disassembly and Assembly, "Final Drive - Remove".

**Note:** Cleanliness is an important factor. Before the disassembly procedure, the exterior of the component should be thoroughly cleaned. This will prevent dirt from entering the internal mechanism.

1. Put an alignment mark across the sections of the final drive for assembly purposes. The parts must be reinstalled in the part's original locations.



Illustration 1

g00708089

2. Fasten the final drive to Tooling (A), as shown. The combined weight of the final drive and final drive sprocket is approximately 312 kg (688 lb).

3. Remove bolts (1) and the washers that hold the cover in position.

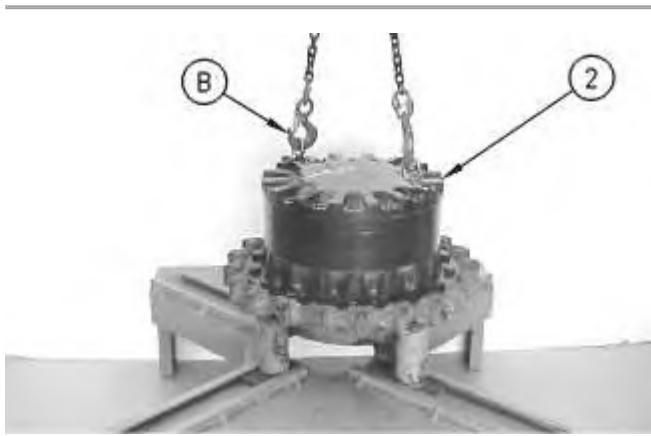

Illustration 2

g00708090

4. Remove the setscrews from the cover. Fasten Tooling (B) and a suitable lifting device to cover (2), as shown. The weight of cover (2) is approximately 32 kg (70 lb). Remove cover (2).

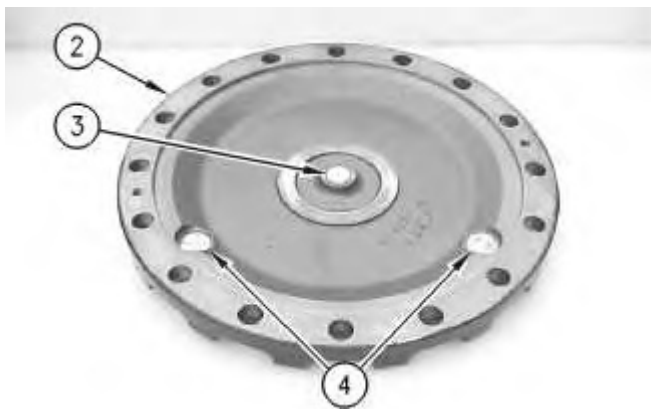
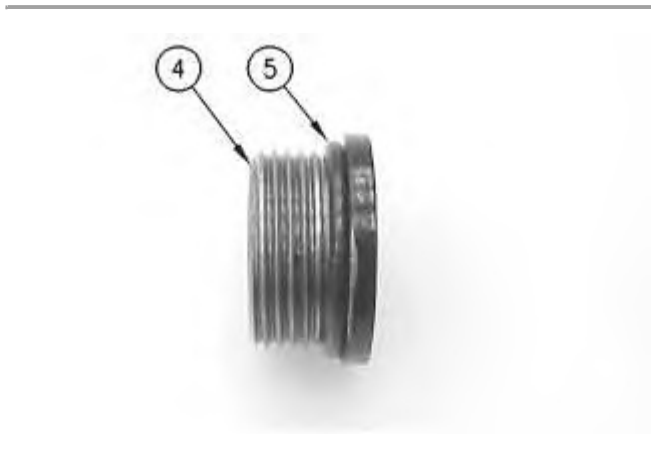

Illustration 3

g00708091

5. Remove thrust plate (3) from cover (2).
6. Remove plugs (4) from cover (2).



**<https://www.ebooklibonline.com>**

Hello dear friend!

Thank you very much for reading.

Enter the link into your browser.

The full manual is available for immediate download.

**<https://www.ebooklibonline.com>**

7. Remove O-ring seals (5) from both plugs (4) that were in the cover.
- 

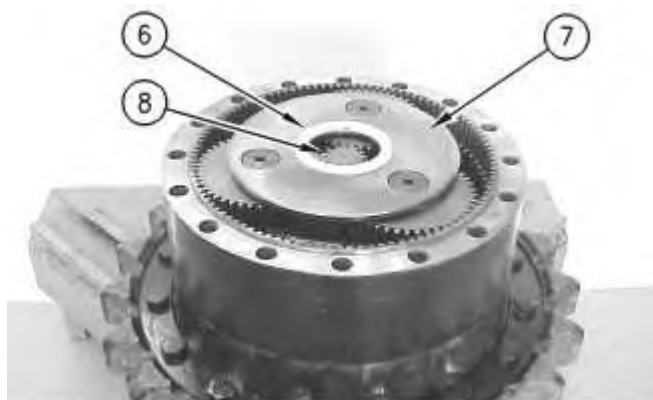

Illustration 5

8. Remove spacer (6) from carrier assembly (7).
  9. Remove sun gear (8) from carrier assembly (7).
  10. Remove carrier assembly (7) by lifting the carrier assembly straight up. The weight of carrier assembly (7) is approximately 14 kg (30 lb).
- 



Illustration 6

11. Disassemble carrier assembly (7), as follows.
    - a. Drive spring pin (10) into planetary shaft (9) with a hammer and a punch.
-



Illustration 7

g00708144

- b. Remove planetary shaft (9) with spring pin (10) from the carrier assembly.
- c. Remove spring pin (10) from planetary shaft (9) with a hammer and a punch.

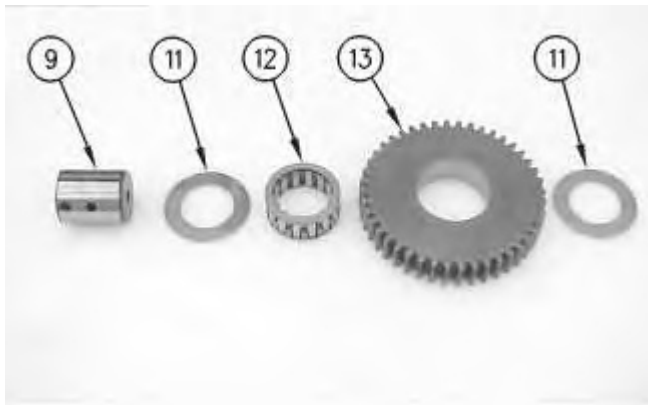

Illustration 8

g00708218

- d. Remove thrust washers (11) and planetary gear (13) from the carrier assembly.
  - e. Remove bearing (12) from planetary gear (13).
12. Repeat Steps 11.a through 11.e in order to remove the remaining planetary gears from the carrier assembly.



13. Remove sun gear (14) from carrier assembly (15).

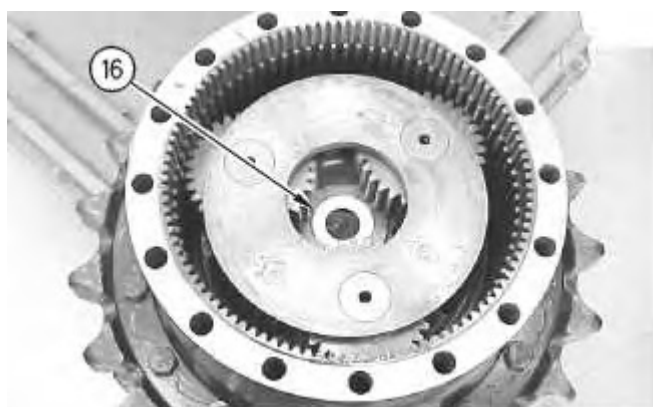

Illustration 10

g00708325

14. Remove spacer (16).

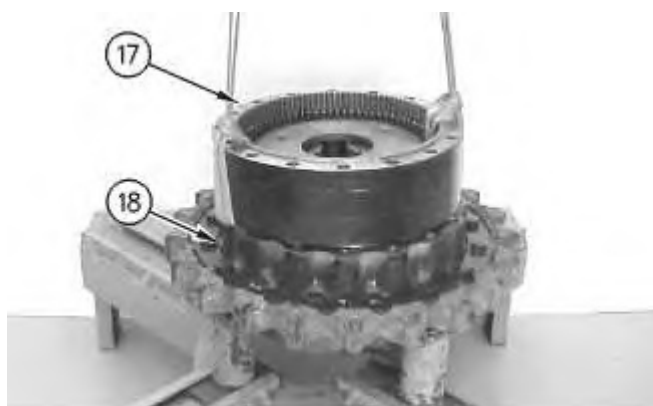

Illustration 11

g00708184

**Note:** It will be necessary to pry ring gears (17) away from main housing (18) in order to install the lifting slings.

15. Fasten a suitable lifting device to ring gears (17), as shown. Remove the ring gears from main housing (18). The weight of ring gears (17) is approximately 45 kg (100 lb).



16. Use a screwdriver or a chisel in order to separate the two ring gears (17).

**Note:** The two ring gears are held together with Tooling (F). It may be necessary to heat the ring gears in order to soften the sealant. Do not heat over 135 °C (275 °F) for more than thirty minutes.

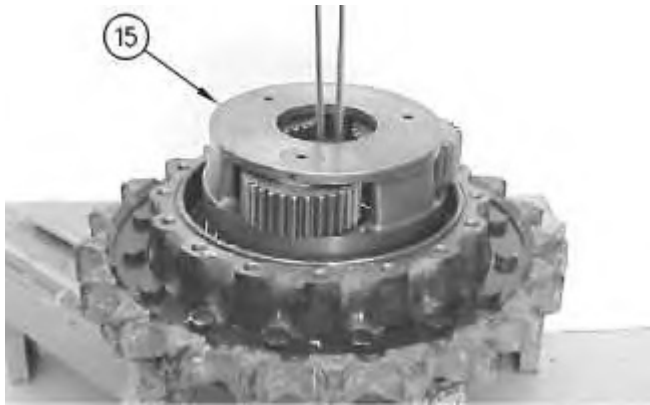

Illustration 13

g00708172

17. Position a 12.7 mm (0.50 inch) shackle under carrier assembly (15).
18. Fasten a suitable lifting device to the shackle.
19. Slowly lift carrier assembly (15) from the final drive. The weight of carrier assembly (15) is approximately 39 kg (85 lb).
20. Disassemble carrier assembly (15), as follows.



Illustration 14

g00708175

- a. Drive spring pin (20) into planetary shaft (19) with a hammer and a punch.
-



Illustration 15

g00708370

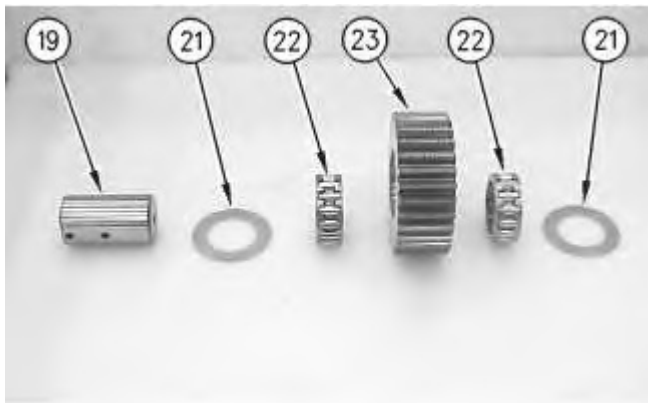
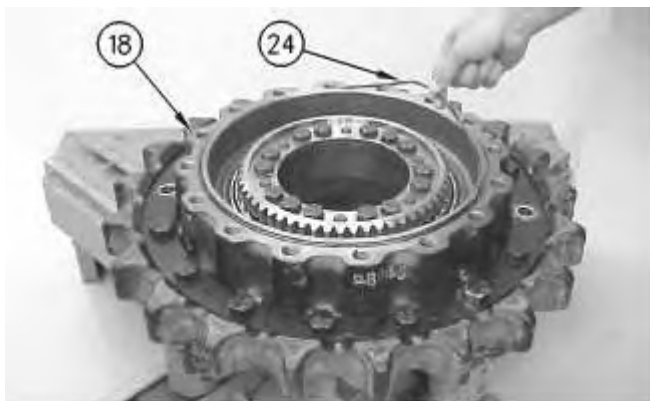

Illustration 16

g00708220

- b. Remove planetary shaft (19) with spring pin (20) from the carrier assembly.
  - c. Remove spring pin (20) from planetary shaft (19) with a hammer and a punch.
  - d. Remove thrust washers (21) and planetary gear (23) from the carrier assembly.
  - e. Remove bearings (22) from planetary gear (23).
21. Repeat Steps 20.a through 20.e in order to remove the remaining planetary gears from the carrier.



22. Remove O-ring seal (24) from main housing (18).
- 



Illustration 18

23. Remove bolts (25) from gear (26).
- 

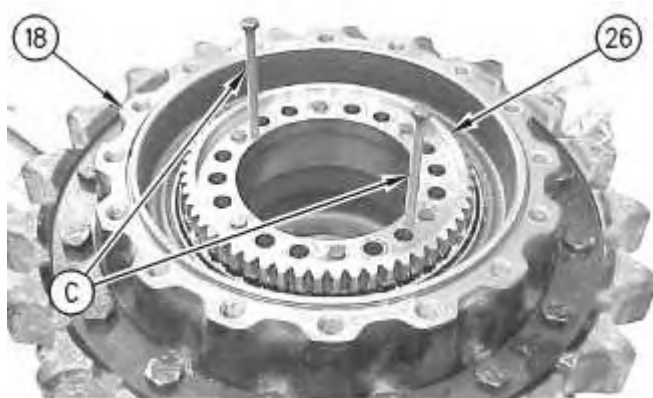

Illustration 19

24. Use Tooling (C) in order to remove gear (26) from main housing (18).

**Note:** The motor housing will separate from the main housing (18) once gear (26) is removed. Make sure that the motor housing is supported.



25. Remove shims (27) from the main housing.
- 

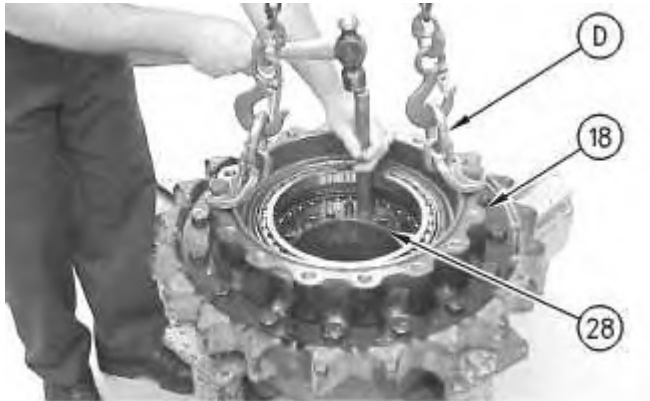

---

Illustration 21

26. Fasten Tooling (D) and a suitable lifting device to main housing (18), as shown.
27. Use a hammer and a punch in order to separate main housing (18) and the final drive sprocket from the motor housing (28). The combined weight of main housing (18) and the final drive sprocket is approximately 82 kg (180 lb).
- 

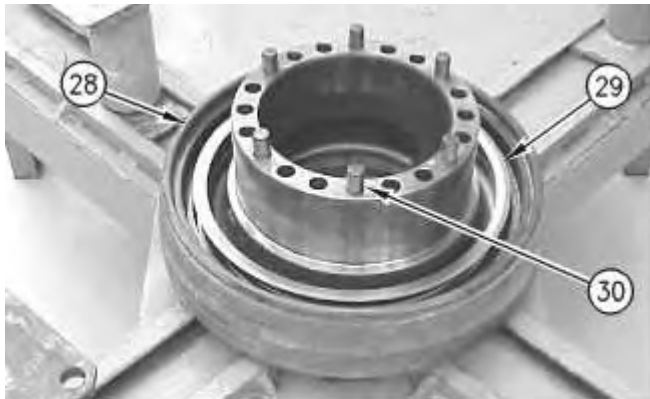

---

Illustration 22

28. Remove Duo-Cone seal (29) from motor housing (28).
29. Remove alignment pins (30).
-

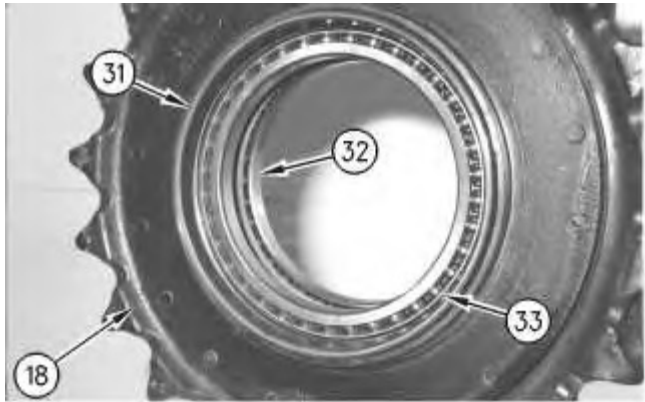

Illustration 23

g00708215

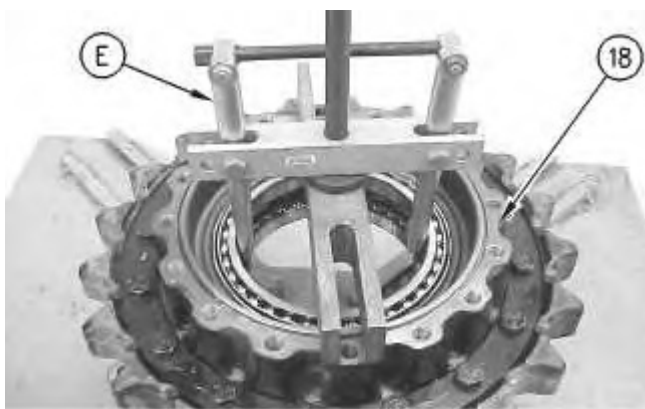

Illustration 24

g00708216

30. Remove Duo-Cone seal (31) from main housing (18).
31. Use Tooling (E) in order to remove bearings (32) and (33) from the main housing.
32. If necessary, remove the final drive sprocket from the main housing.
33. Refer to Disassembly and Assembly, "Final Drive Sprocket - Remove and Install".

[Previous Screen](#)

Product: EXCAVATOR

Model: 324D LN EXCAVATOR EJC

Configuration: 324D L &amp; LN Excavator EJC00001-UP (MACHINE) POWERED BY C-7 Engine

## Disassembly and Assembly

### 324D, 325D, 326D and 329D Excavators and 329D MHPU Mobile Hydraulic Power Unit Machine Systems

Media Number -REN8646-22

Publication Date -01/02/2015

Date Updated -12/09/2018

i02783051

## Final Drive - Disassemble

SMCS - 4050-015

S/N - A3R1-1021

S/N - AZP1-UP

S/N - DBH1-UP

S/N - EJC1-643

S/N - GBR1-UP

S/N - GPB1-801

S/N - JJG1-813

S/N - KBE1-UP

S/N - LAB1-415

S/N - LAL1-250

S/N - MCL1-201

S/N - NAC1-250

S/N - PAL1-UP

S/N - PKE1-814

S/N - SCR1-774

S/N - SYM1-617

S/N - T2D1-322

S/N - T2S1-UP

## Disassembly Procedure

Table 1

Required Tools			
Tool	Part Number	Part Description	Qty
A	1P-2420	Transmission Repair Stand	1
B	138-7573	Link Bracket	2
C	1P-1863	Retaining Ring Pliers	1
D	194-3878	Spanner Socket	1
E	138-7574	Link Bracket	2
F	5F-7366	Forcing Screw	1
	1P-5546	Crossblock	1
	1U-9889	Crossblock	1
	1P-0520	Driver Group	1
	6V-7888	Puller Leg	2
	1H-3112	Puller Assembly	1
	1P-5551	Adjustable Screw Assembly	1
G	1U-7600	Slide Hammer Puller Gp	1
	8T-0266	Bolt	1

### Start By:

- a. Remove the final drive. Refer to Disassembly and Assembly, "Final Drive - Remove".

**Note:** Cleanliness is an important factor. Before the disassembly procedure, the exterior of the component should be thoroughly cleaned. This will prevent dirt from entering the internal mechanism.

**Note:** Some of the images that are in this procedure do not show the sprocket assembly that is attached to the final drive housing. If necessary, the weights that are given include the weight of the sprocket assembly.

1. Put an alignment mark across the sections of the final drive for assembly purposes. The parts must be reinstalled in the part's original locations.
-



Illustration 1

g00708089

2. Fasten the final drive to Tooling (A), as shown. The weight of the final drive assembly is approximately 312 kg (688 lb).
3. Remove bolts (1) and the washers that hold the cover in position.

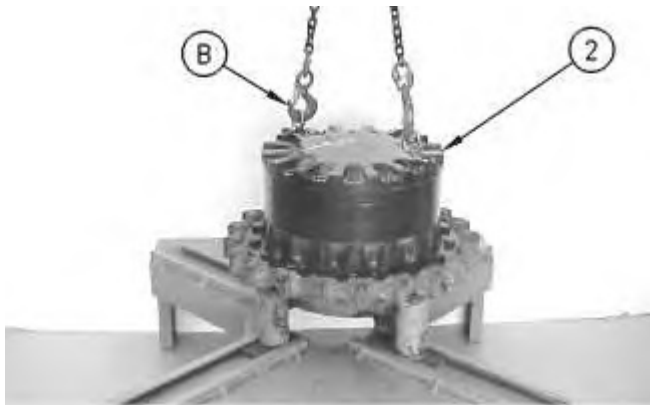

Illustration 2

g00708090

4. Remove the setscrews from the cover. Fasten Tooling (B) and a suitable lifting device to cover (2), as shown. Remove the cover. The weight of the cover is approximately 32 kg (70 lb).

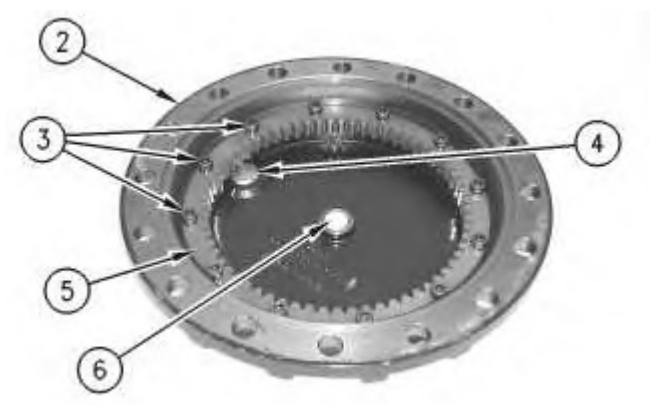

Illustration 3

g00879362

5. Remove bolts (3). Remove gear (5). Check plate (6). Replace plate (6) if wear is shown. Remove plugs (4) from cover (2).

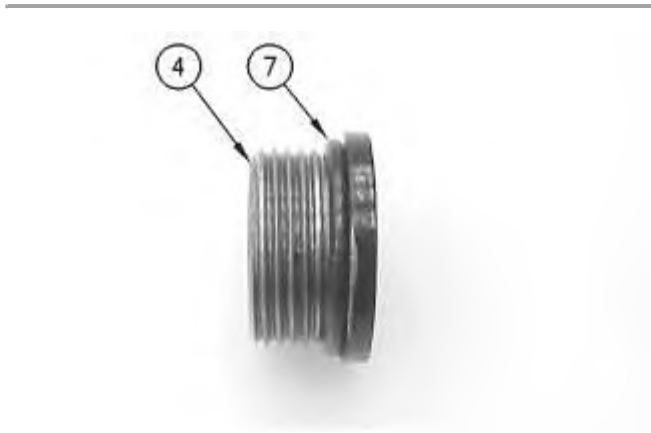

Illustration 4

g00879365

6. Remove O-ring seal (7) from plugs (4).



Illustration 5

g00780428

7. Remove gear (8). Remove spacer (9).



Illustration 6

g00780432

8. Remove retaining ring (10) with Tooling (C). Remove washer (11). Remove gear (12). Remove bearing assembly (13). Remove second washer (11).
9. Repeat Step 8 for the remaining two gear assemblies.

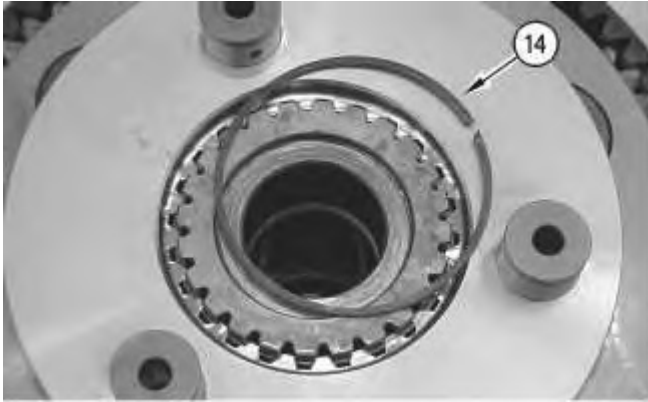

Illustration 7

g00781401

10. Remove retaining ring (14).



Illustration 8

g00781407

11. Remove carrier assembly (15).
-

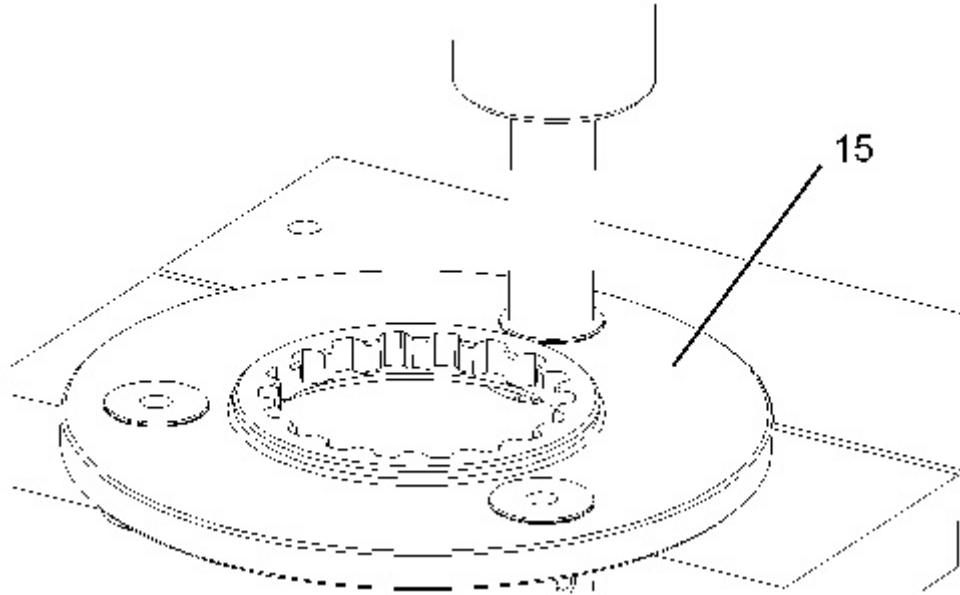

Illustration 9

g01389593

12. Use a suitable press in order to remove the shafts from carrier assembly (15).

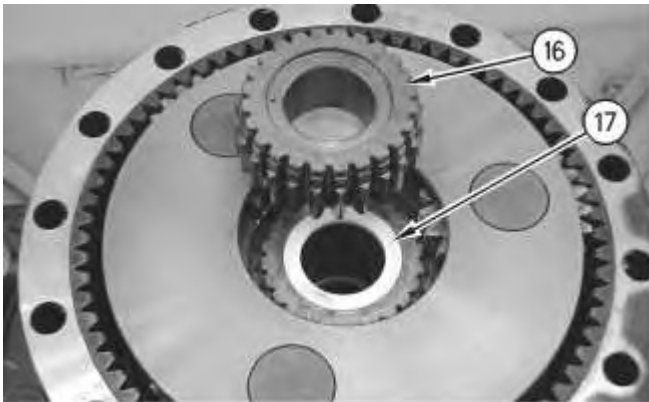

Illustration 10

g00781412

13. Remove gear (16). Remove spacer (17).



Illustration 11

g00781466

14. Remove retaining ring (18).

15. Remove carrier assembly (19).

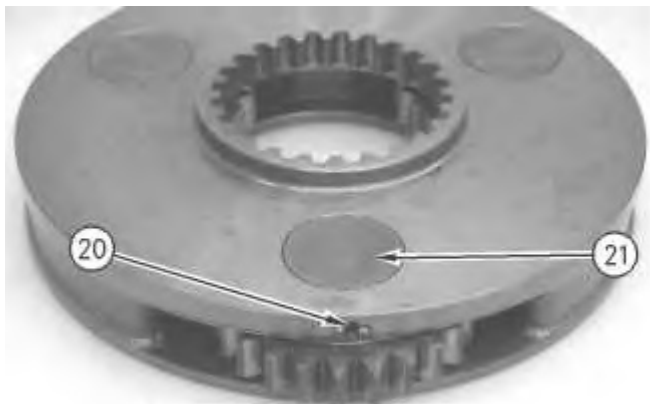

Illustration 12

g00879368

16. Disassemble carrier assembly (19), as follows.

a. Drive spring pin (20) into planetary shaft (21) with a hammer and a punch.

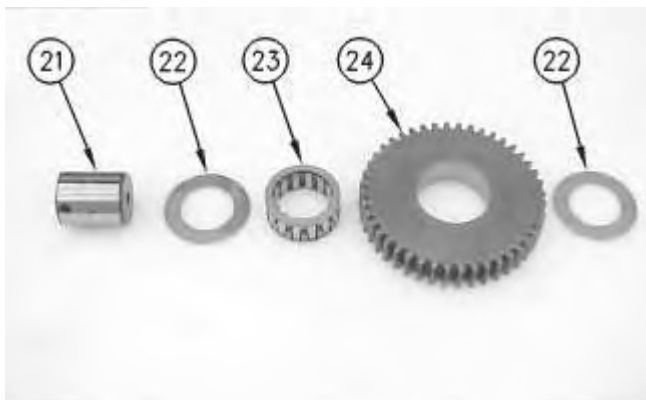

Illustration 13

g00781476

b. Remove planetary shaft (21).

c. Remove spring pin (20) from planetary shaft (21) with a hammer and a punch.



- d. Remove thrust washers (22) and planetary gear (24) from the carrier assembly.
  - e. Remove bearing (23) from planetary gear (24).
17. Repeat Steps 16.a through 16.e for the other two planetary.

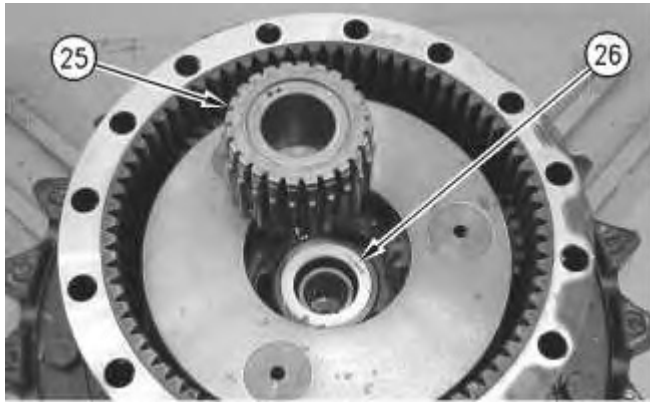

Illustration 15

18. Remove gear (25). Remove spacer (26).

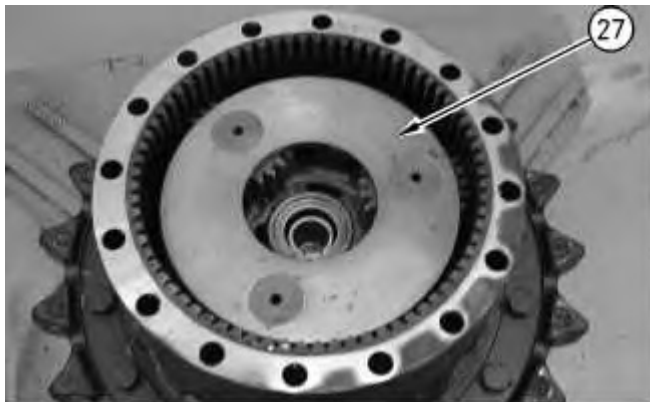

Illustration 16

19. Remove carrier assembly (27).
20. Use two people to remove carrier assembly (27). The weight of the carrier assembly is approximately 38 kg (85 lb).
21. Disassemble carrier assembly (27), as follows.
-



Illustration 17

g00781719

- a. Drive spring pin (29) into planetary shaft (28) with a hammer and a punch.



Illustration 18

g00781601

- b. Remove planetary shaft (28).
- c. Remove spring pin (29) from planetary shaft (28) with a hammer and a punch.

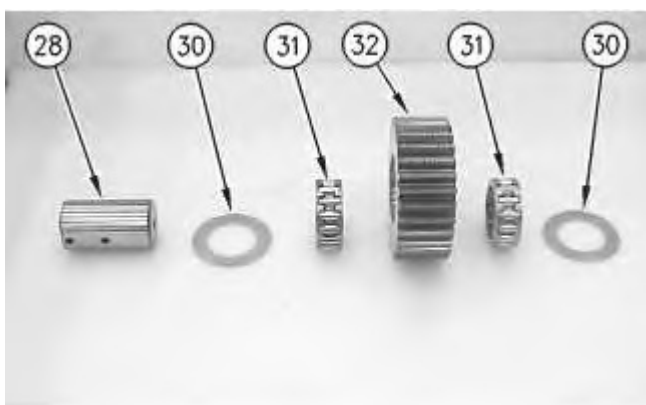

Illustration 19

g00781607

- d. Remove thrust washers (30) and planetary gear (32) from the carrier assembly.
- e. Remove two bearings (31) from the planetary gear.

22. Repeat Steps 21.a through 21.e for the other two planetary gears.



Illustration 20

g00781730

23. Use two people to remove gear (33). The weight of gear is approximately 41 kg (90 lb).



Illustration 21

g00781807

24. Remove O-ring seal (34).

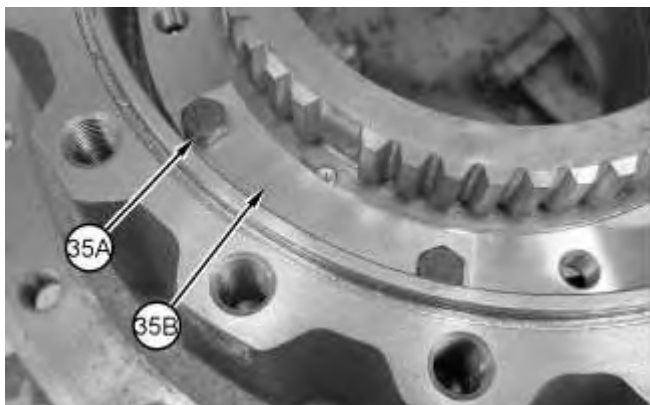

Illustration 22

g01147650

25. Remove bolts (35A) and plates (35B).

---

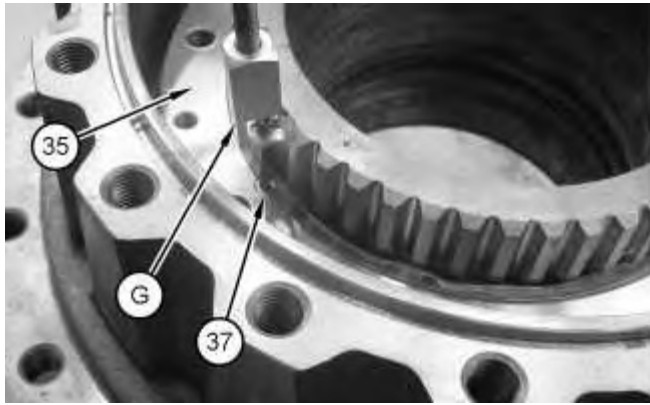

Illustration 23

g01147651

26. Use Tooling (G) to remove dowel (37) from stopper plate (35).

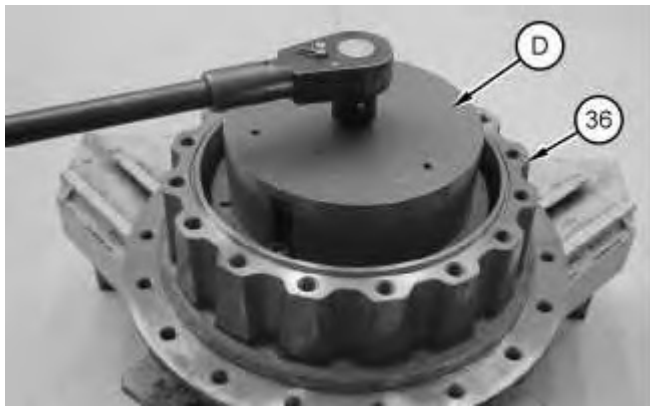

Illustration 24

g01147759

27. Secure Tooling (D) to stopper plate (35). Use Tooling (D) to remove stopper plate (35).

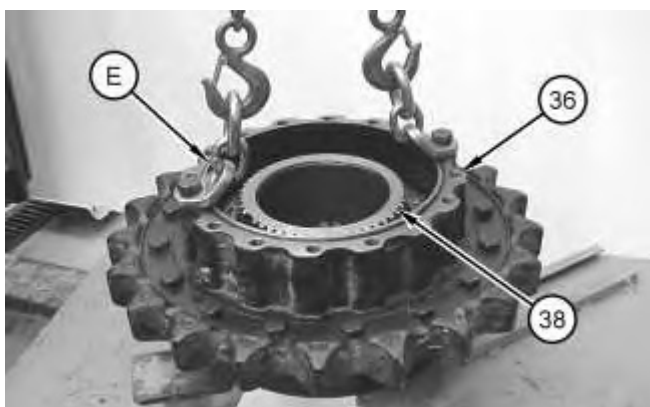

Illustration 25

g01147930

28. Use Tooling (E) and a suitable lifting device to remove housing (36). The weight of housing (36) is approximately 100 kg (220 lb).



**Suggest:**

**If the above button click is invalid.**

**Please download this document**

**first, and then click the above link**

**to download the complete manual.**

**Thank you so much for reading**

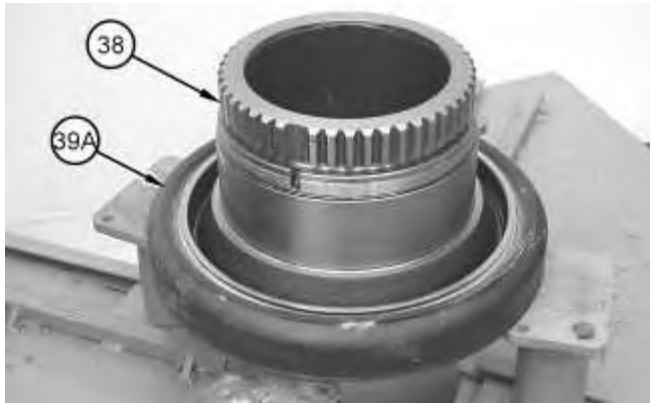

Illustration 26

g01147951

29. Remove Duo-Cone seal (39A) from housing (38).



Illustration 27

g01147975

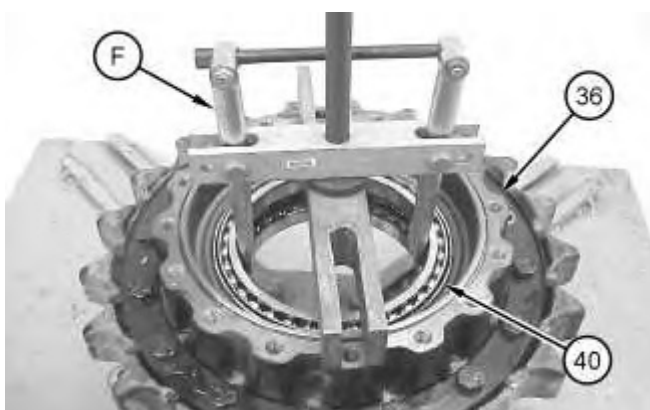

Illustration 28

g01147934

30. Remove Duo-Cone seal (39B) from housing (36).
31. Use Tooling (F) in order to remove bearings (40) and (41) from housing (36).
32. If necessary, remove the final drive sprocket from the sprocket housing. Refer to Disassembly and Assembly, "Final Drive Sprocket - Remove and Install".

**<https://www.ebooklibonline.com>**

Hello dear friend!

Thank you very much for reading.

Enter the link into your browser.

The full manual is available for immediate download.

**<https://www.ebooklibonline.com>**