

W3
WHEEL TRACTOR
Service Manual

9-70451

Reprinted

CASE

W3 WHEEL TRACTOR LOADER TABLE OF CONTENTS

SECTION	DESCRIPTION	FORM NO.
I	Splitting the Tractor	9-70451
II	Gasoline Engine	9-70451
III	Diesel Engine	9-70451
IV	Torque Converter Drive	9-70451
V	Part One - Four Speed Transmission and Rear Axle Assembly	9-70451
	Part Two - Dual Range Assembly	9-70451
	Part Three - Shuttle Assembly	9-70451
VI	Loader and Backhoe	9-70451
P	Servicing the Power Steering Pump	9-74741
R	Servicing the 2000 Series Gear Type Hydraulic Pump	9-74741
S	Servicing the Hydraulic Power Shuttle	9-74741
	Servicing the Hydraulic Cylinders on Case W5 Gasoline Terraload'rs	9-74451

SECTION I

SPLITTING TRACTOR

AND

TRACTOR SPECIFICATIONS & LUBRICATION

TABLE OF CONTENTS

	PAGE
GROUP A — TRACTOR SPECIFICATIONS	I-3
1. SPECIFICATIONS	I-3
2. TRACTOR SERIAL NUMBER LOCATION	I-4
3. ENGINE LUBRICATION	I-4
4. TRACTOR LUBRICATION	I-8
5. FUEL SPECIFICATIONS (GASOLINE)	I-15
6. FUEL SPECIFICATIONS (DIESEL)	I-15
GROUP B — SPLITTING TRACTOR	I-20
1. REMOVING BACKHOE	I-20
2. REMOVING LOADER	I-22
3. TOOLS FOR SPLITTING TRACTOR	I-24
4. TRACTOR SHROUD, HOOD, ETC.	I-28
5. SPLITTING TRACTOR AT FRONT OF TRANSMISSION	I-29
6. SPLITTING TRACTOR AT REAR OF ENGINE	I-32
7. SPLITTING TRACTOR AT FRONT OF ENGINE	I-36
8. FUEL TANK	I-41
9. REAR FENDERS AND STEP PLATES	I-43

<https://www.ebooklibonline.com>

Hello dear friend!

Thank you very much for reading.

Enter the link into your browser.

The full manual is available for immediate download.

<https://www.ebooklibonline.com>

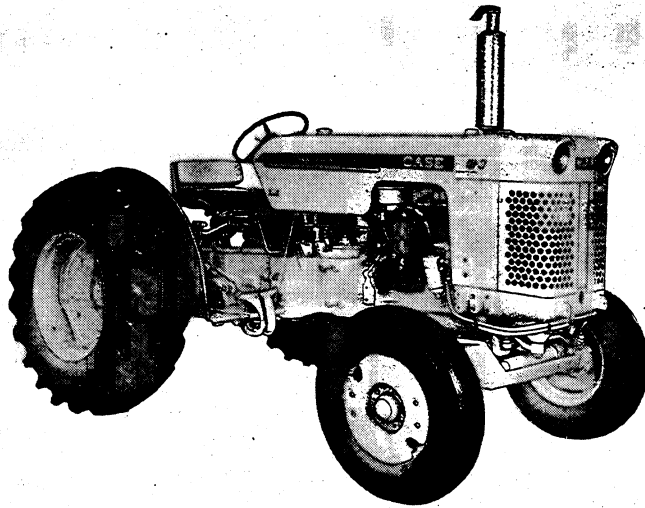

874461

Right Hand Front View - Drawbar Model

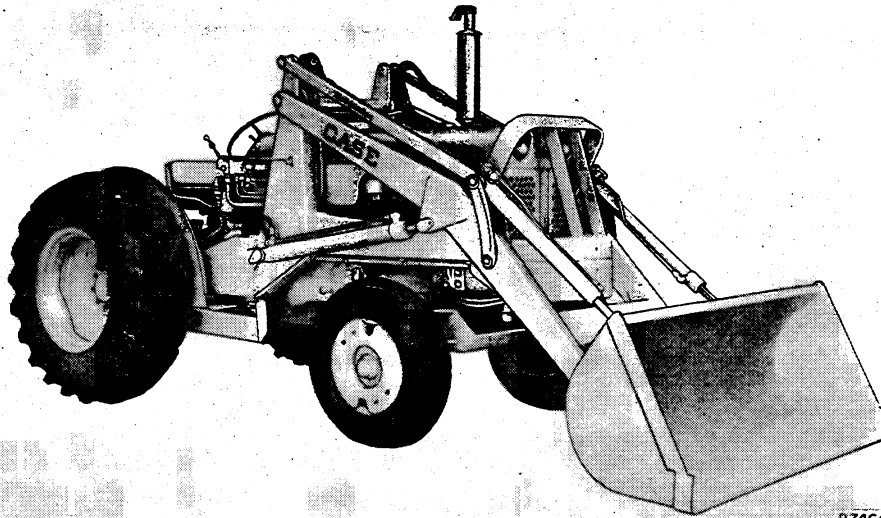

874661

Right Hand Front View - Loader Model

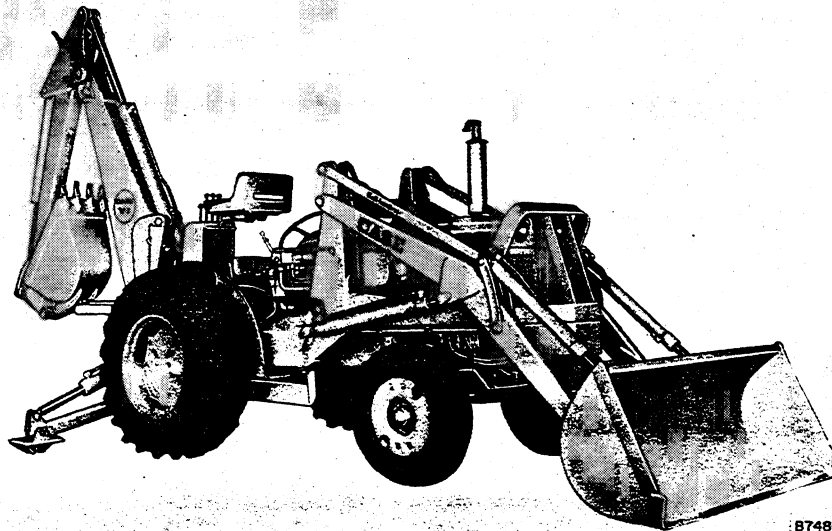

874861

Right Hand Front View - Loader - Backhoe Model

GROUP A - TRACTOR SPECIFICATIONS

1. SPECIFICATIONS

APPROXIMATE REFILL CAPACITIES

	U. S. Measure
Cooling System	(Gas - 14 Quarts — Diesel 16-1/2 Quarts)
Engine Crankcase (Gas and Diesel)	4 Quarts
(with filter change)	5 Quarts
Air Cleaner Oil Cup (Gas)	1 Quart
(Diesel)	2-3/4 Pints
Torque Tube Hydraulic System and Torque Converter Drive System	16 Quarts
Fuel Tank	22 Gallons
Transmission Case	17 Quarts
Belt Pulley Housing	1 Pint
Independent P.T.O.	1 Quart

★TRAVEL SPEEDS

SPEEDS — DIRECT DRIVE

	Low Range				High Range			
	1st	2nd	3rd	4th	1st	2nd	3rd	4th
Forward	1.9	2.8	3.7	12.9	3.1	4.5	5.9	20.8
Reverse	2.4	3.5	4.6	16.0	3.8	5.6	7.3	25.9

SPEEDS — TORQUE CONVERTER DRIVE

	Low Range				High Range			
	1st	2nd	3rd	4th	1st	2nd	3rd	4th
Forward	1.5	2.2	2.9	10.3	2.4	3.6	4.7	16.6
Reverse	1.9	2.8	3.6	12.9	3.0	4.5	5.9	20.6

*@ 2100 engine R.P.M. with 14.9 x 24 tires

TIRES

TIRE SIZES

Front Tires	7.50-16, 10 ply
Rear Tires	14.9-24, 6 ply

TIRE PRESSURES (DRAWBAR MODEL)

Front Tires	20 P.S.I.
Rear Tires	14 P.S.I.

TIRE PRESSURES (LOADER, BACKHOE, OR OTHER HEAVY EQUIPMENT)

Front Tires	36 P.S.I.
Rear Tires	18 P.S.I.

GENERAL DIMENSIONS

Front Wheel Tread	53 Inches
Rear Wheel Spacing (Integral Wheels)	58 Inches and 66 Inches
(Demountable Rims)	48 Inches to 76 Inches
Overall Width (Minimum)	63-1/2 Inches
Turning Radius (Without brakes)	120 Inches
Front Wheel Toe-In	1/8 Inch to 3/16 Inch
Wheelbase	75-1/2 Inches

2. TRACTOR SERIAL NUMBER LOCATION

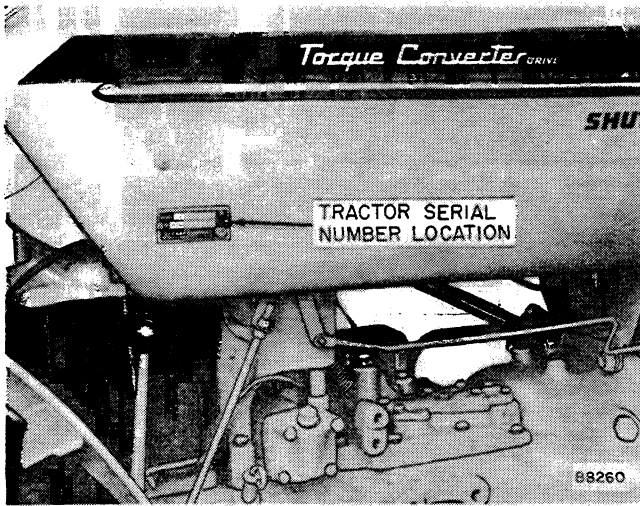

Figure 1 - Tractor Serial Number Location

The letter "G" or "D" after Model W3 on the serial number plates indicates whether the Tractor is gas or Diesel. The letter "H" indicates a high speed fourth gear.

All W3 Tractors include as standard equipment: Torque Converter Drive; Shuttle Transmission; Dual-Range Transmission; and high speed 4th gear.

EXAMPLE: W3 G-H indicates a gasoline Model W3 Tractor with high speed 4th gear.

Always state the model and serial numbers on the following plates when ordering parts or corresponding about a specific unit:

- Tractor;
- Engine;
- Loader;
- Backhoe.

3. ENGINE LUBRICATION

It is extremely important that a stable, high quality engine lubricating oil is selected for use in the Model "W3" Wheel Tractor's engine. It is also extremely important that the correct weight (SAE Viscosity Rating) of oil is selected, depending upon the prevailing air temperatures.

Using lubricating oils of the recommended SAE Viscosity Rating assures you that the oil will remain

fluid or free flowing within the specified air temperature ranges. The use of either heavier or lighter body oils than recommended may seriously affect engine lubrication and performance. Too light an oil used during warm temperatures may result in high oil consumption and is apt to cause increased engine wear. Using too heavy an oil during cold temperatures will affect starting, and may result in a poor rate of lubricant distribution causing increased wear.

OIL — GASOLINE ENGINE

	Average Daytime Air Temperatures
SAE 30	Above 90° F
SAE 20-W	From 90° F to 32° F
*SAE 10-W	From 32° F to -10° F
SAE-5W	†Below -10° F

*SAE 10W-30 may be used in this temperature range.

† NOTE: If the Tractor is to operate under a heavy constant load during extremely cold weather, it is advisable to use SAE 10-W. It may then be necessary to drain the oil while it is still hot and pre-heat it to approximately 100 degrees Fahrenheit before pouring it back into the crankcase just prior to starting.

GAS ENGINE LUBRICATING OIL SERVICE DESIGNATIONS

To simplify the selection of a suitable engine lubricating oil to meet any spark ignition service conditions, the American Petroleum Institute (composed of most major oil companies and refineries) have adopted three service designations for gasoline engine use:

1. Service "ML" — Not recommended for Tractor engine use.
2. Service "MM" — Moderate to severe engine service.
3. Service "MS" — Severe engine service.

The above designations will usually be marked on the oil container.

SERVICE "MM" — Moderate to severe engine use where there are no harmful low or high operating temperatures, or no prolonged idling.

SERVICE "MS" — For severe engine service such as:

1. Low temperature engine operating conditions as a result of frequent stop and start operations, prolonged idling, operating with a light load (especially during cold weather).
2. High temperature engine operating conditions as a result of heavy loads during very hot weather. Lubricating oils that do not have protective additives to withstand high temperatures may break down under this type of condition, resulting in excessive engine wear and deposits.

OIL — DIESEL ENGINE

	Average Daytime Air Temperatures
SAE 30 (SERVICE DS)	Above 90° F
SAE 20-W (SERVICE DS)	From 90° F to 32° F
SAE 10-W (SERVICE DS)	From 32° F to 0° F
SAE 5W-20 (SERVICE DS)	*Below 0° F

*NOTE: If the Tractor is to operate under a heavy, constant load during extremely cold weather, it is advisable to use SAE 10-W oil. It may then be necessary to drain the oil while it is still hot and pre-heat it to approximately 100° F, before pouring it back into the crankcase, just prior to starting.

DIESEL ENGINE LUBRICATING OIL SERVICE DESIGNATIONS

To simplify the selection of a suitable engine lubricating oil to meet Diesel engine service conditions, the American Petroleum Institute (composed of most major oil companies and refineries) have adopted three service designations for Diesel engine service use:

SERVICE "DG" (DIESEL — GENERAL) — Not recommended for Model W3 Tractor engine use.

SERVICE "DM" (DIESEL — MEDIUM) — Not recommended for Model W3 Tractor engine use.

SERVICE "DS" (DIESEL — SEVERE) — Recommended for all types of operation. Series 3 oil is also acceptable.

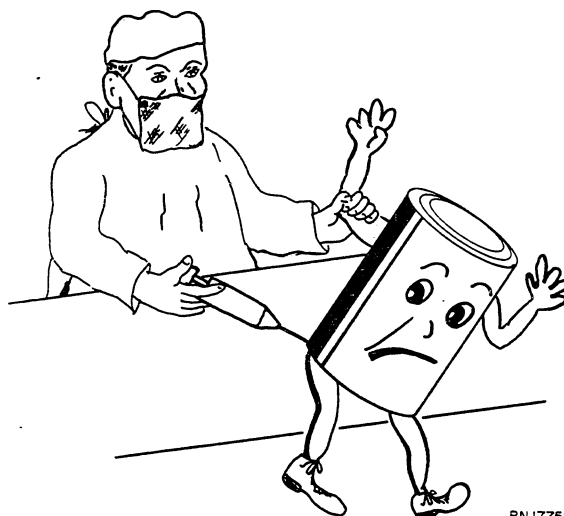

BN 17759

ADDITIVE TYPE OIL

The terms "Heavy Duty" and "Extra Heavy Duty" types of oils do not refer to the weight or body (SAE Viscosity) of an oil. Heavy Duty or Extra Heavy Duty oils are detergent or additive type oils to which chemicals have been added in order to:

1. Make the oil more resistant to oxidation and corrosive substances such as sulphur.
2. Improve some property of the oil, such as its pour point or ability to withstand heat and pressure.
3. Give the oil the ability to aid in preventing harmful deposits by holding carbon, sludge, etc., in suspension in the oil.

IMPORTANT: Change the crankcase oil frequently when severe operating conditions exist. The oil will eventually become saturated with contaminants and lose its protective properties.

AN IMPORTANT PRECAUTION FOR DIESEL ENGINES: Before using a new Diesel Tractor in the field, drain factory installed, special preservative oil from the crankcase. Refill crankcase with Service DS (or Series 3) oil of the correct viscosity for the prevailing air temperature.

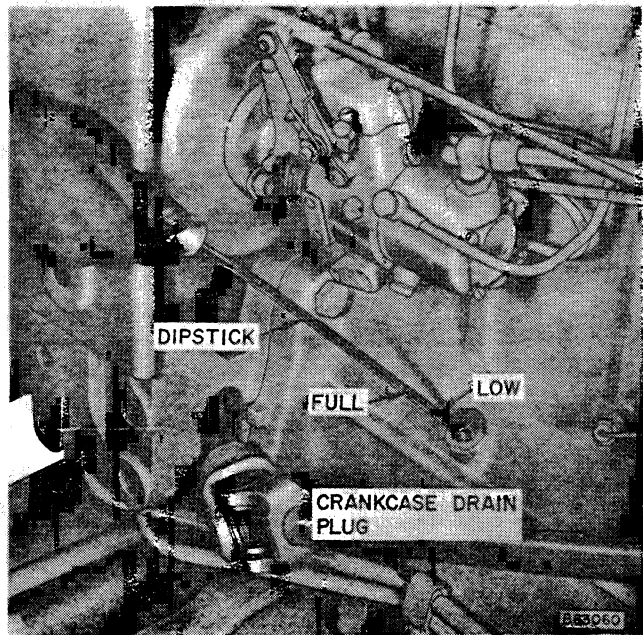

Figure 3 - Checking Oil Level (Diesel Engine)

CHECKING CRANKCASE OIL LEVEL

Check the engine oil level daily, before starting the day's work, by means of the bayonet gauge rod (dipstick), see Figures 2 and 3. The dipstick has "FULL" and "LOW" marks. Add sufficient oil through filler opening to have oil level just reach the "FULL" mark. **DO NOT OVERFILL.**

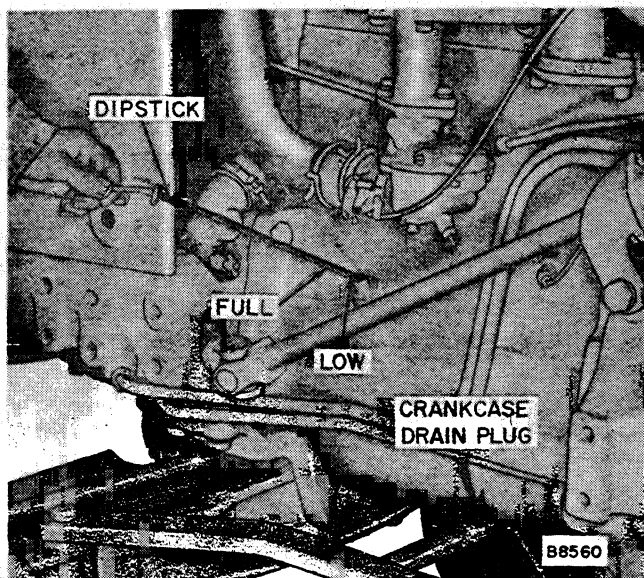

Figure 2 - Checking Oil Level (Gasoline Engine)

When adding oil, allow sufficient time for the oil to run down before checking oil level. Never attempt to check crankcase oil level while the engine is running.

CRANKCASE OIL CHANGE

Crankcase Capacity 4 U. S. Quarts
 (With Filter Change) 5 U. S. Quarts
 Change Frequency . . After first 20 hours operation,
 then every 100 hours there-
 after.

ON DIESEL ENGINES: Before using a new Diesel Tractor in the field, drain factory-installed, special preservative oil from the crankcase. Refill crankcase with Service DS (or Series 3) oil of the correct viscosity for the prevailing air temperature.

1. Drain oil, while hot, after the first 20 hours of operation; also change filter element. See Figures 2 and 3 for location of drain plug. After the initial oil change, change the oil after every 100 hours operation.

Allow oil to drain for several minutes, replace the plug (with gasket in place) and tighten securely.

If engine service is severe — frequent starting and stopping, high or low operating temperatures — the crankcase should be drained more often to prevent the formation of sludge and harmful deposits in the engine.

2. Fill crankcase with correct oil, see chart and Figure 6. Always use service MG or MS in gasoline engines; service DS (or Series 3) in Diesel engines. Fill to "FULL" mark on dipstick.

Always use a high-quality, stable engine oil having the correct A.P.I. service designation and the correct viscosity.

ENGINE OIL FILTER

Change Frequency . . . After first 20 hours operation.
Then every other oil change
or a maximum of 200 hours,
whichever occurs first.

Change the oil filter after the first 20 hours operation and then at least every 200 hours operation thereafter. NEVER ATTEMPT TO CHANGE AN OIL FILTER WHILE THE ENGINE IS RUNNING.

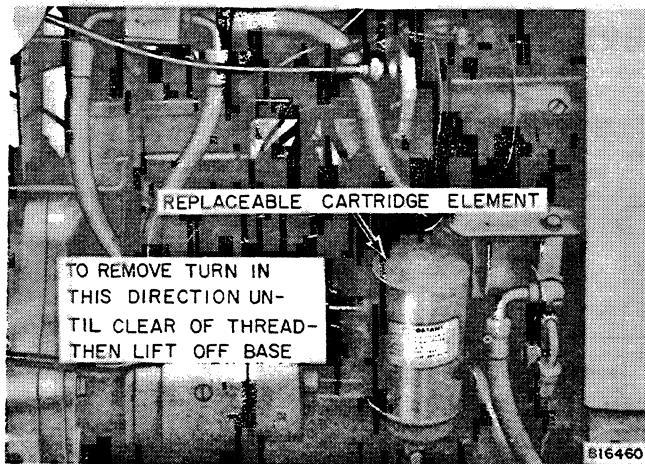

Figure 4 - Oil Filter (Gasoline Engine)

Before removing the filter cartridge, be sure to clean all traces of dirt from around the base joint. Unscrew the filter from the base as shown in Figures 4 or 5.

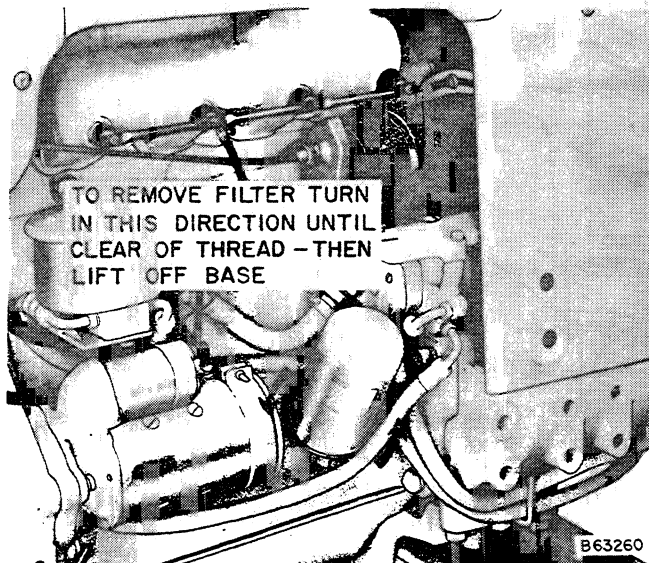

Figure 5 - Oil Filter (Diesel Engine)

To install a new cartridge, apply a film of oil to the gasket and then hand turn until the filter contacts the base — then tighten one-half turn (180°) more. DO NOT OVERTIGHTEN. Be sure to use a genuine CASE cartridge to ensure maximum filtration.

Always add one extra quart of oil to the crankcase each time the filter is changed.

CRANKCASE BREATHER

This filler cap serves as a breather for the crankcase. A fine wire mesh inside the cap prevents entry of dirt into the engine, see Figure 6. Wash the filler cap in solvent every week. Dip in oil, allow to drain, and replace on the filler spout.

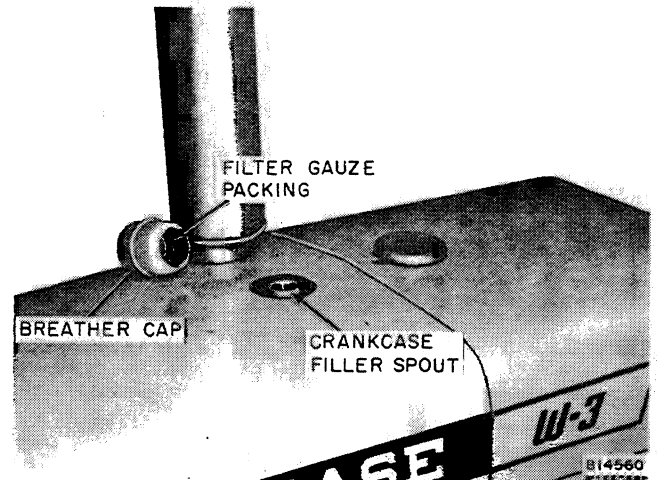

Figure 6 - Crankcase Breather

AIR CLEANER

Capacity (Gasoline Engine) 1 U. S. Quart
(Diesel Engine) 2-3/4 U. S. Pints

The air cleaner oil cup must be removed, cleaned, and refilled exactly to the "Oil Level" mark, every 4 to 10 hours, depending upon operating conditions.



Figure 7 - Air Cleaner

Referring to Figure 7, unscrew the clamp sufficiently to allow the oil cup to be removed straight down from the air cleaner body. Periodically, when cleaning the cup, extract the inner baffle and clean in solvent.

Refill cup to "Oil Level" mark with oil of the following viscosity (or use same viscosity as in engine crankcase):

- Freezing Weather SAE 10
- Warm Weather SAE 30
- Hot Weather SAE 40

Replace cup and secure with thumbscrew clamp. DO NOT OVERFILL THE OIL CUP. ON DIESEL ENGINES THE SURPLUS WILL BE DRAWN INTO THE ENGINE RESULTING IN EXCESSIVE, UNCONTROLLABLE SPEEDS.

4. TRACTOR LUBRICATION

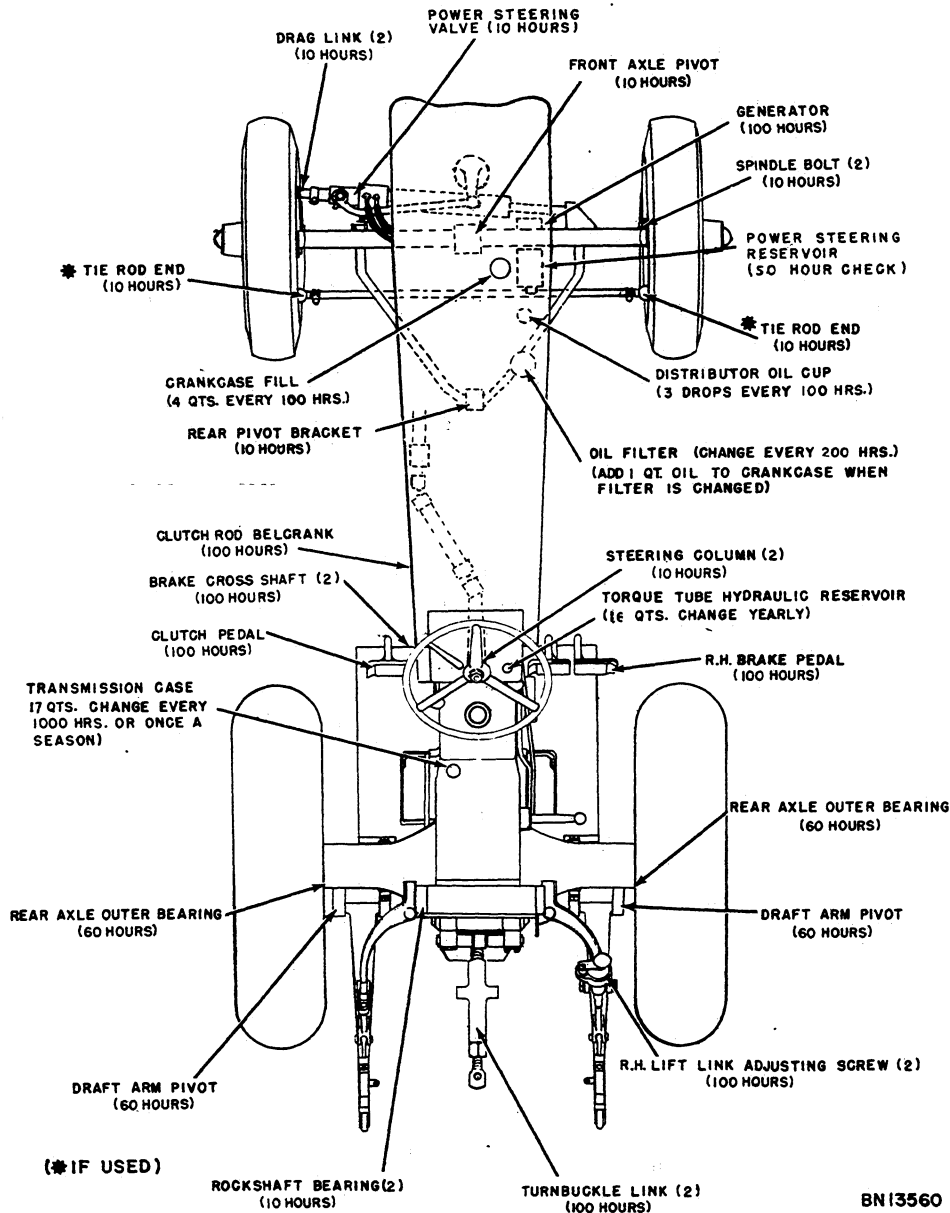

Figure 8 - Basic Tractor Pressure Fittings

PRESSURE FITTINGS

wipe all accumulated dirt from each fitting tip.

Before applying a grease gun to pressure fittings,

RECOMMENDED LUBRICANT

Pressure Fittings . . . Lithium "soap-base" grease

Grade Recommendations — Winter #1
 Summer #2
 Tropical Areas #3

FRONT WHEEL BEARINGS

Front wheel bearings are properly adjusted and packed with grease at the factory. Under normal conditions, front wheels will require no attention for the first 500 hours of operation. Use a good grade Wheel Bearing Grease when bearings are repacked.

GENERATOR

Every 100 hours add a few drops of SAE 10W engine oil to each of the oil cups. DO NOT OVER-LUBRICATE, especially at the rear bearing (commutator end).

DISTRIBUTOR

Every 100 hours remove the distributor cap, without taking the wires from cap terminals. Place 2 to 3 drops of SAE 10W motor oil on the wick under the rotor.

STEERING GEAR HOUSING

Check the fluid level in the steering gear housing every 250 hours. Remove radiator grille, clean all dirt from around the pipe plug, then extract the pipe plug. Test fluid level by inserting a short clean rod straight down, until it touches the worm gear. The lubricant level should be just high enough to cover the worm gear. DO NOT OVERFILL.

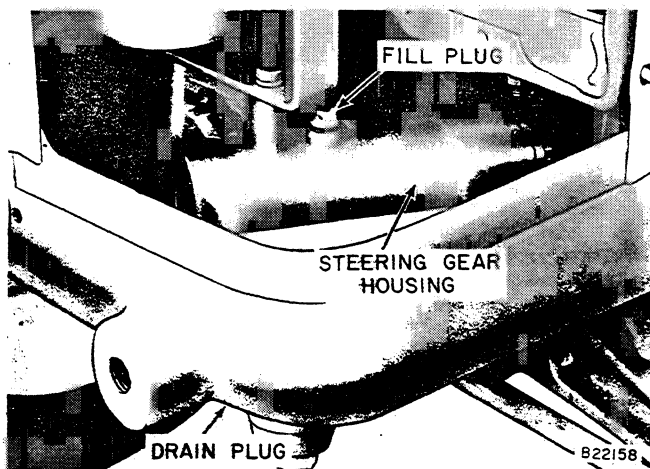

Figure 9 - Steering Gear Plug

Use only SAE 140 or No. 90 E.P. Multi-Purpose Type Lubricant in this housing, both summer and winter.

SPEEDOMETER AND TACHOMETER

Every 1000 hours or yearly, unscrew the oil wick tubes from both the tachometer and the speedometer housings and apply 2 drops of light oil to the wicks. Screw wick holders back in place in the two housings.

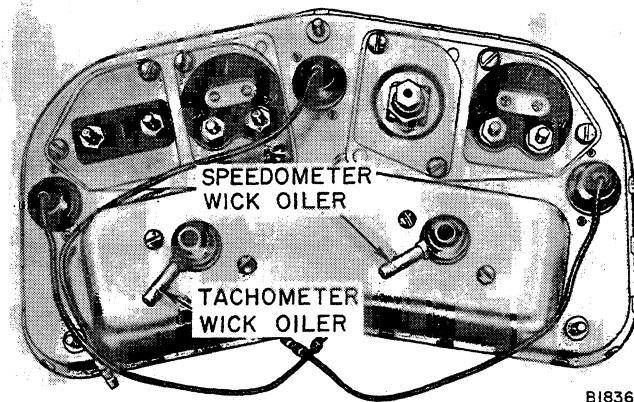

Figure 10 - Instrument Wick Oilers

TRANSMISSION AND FINAL DRIVE

Capacity 17 U. S. Quarts
 Oil Recommendation
 (Summer and Winter) . . . No. 90 E.P. Multi-Purpose Type Lubricant

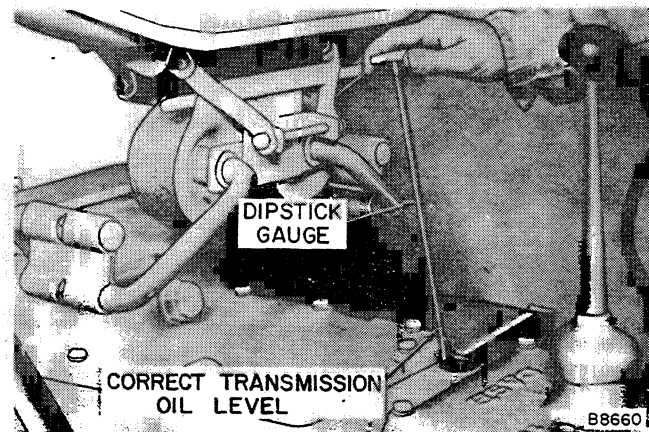

Figure 11 - Checking Transmission and Final Drive Oil Level

Every 50 hours remove the dipstick plug and check the oil level, see Figure 11. The oil level should be to the notch on the dipstick for satisfactory lubrication. When the P.T.O. is used with the Tractor stationary, the oil level MUST be up to the notch on the dipstick. Be sure the Tractor is standing level when making this check, and dipstick screwed completely down.

DRAINING TRANSMISSION AND FINAL DRIVE

Drain transmission case (while oil is warm), every 1000 hours of operation or once a season, whichever occurs first. See Figure 12 for location of transmission — final drive drain plug. Flush transmission case with solvent, allow to drain thoroughly, and refill with new oil.

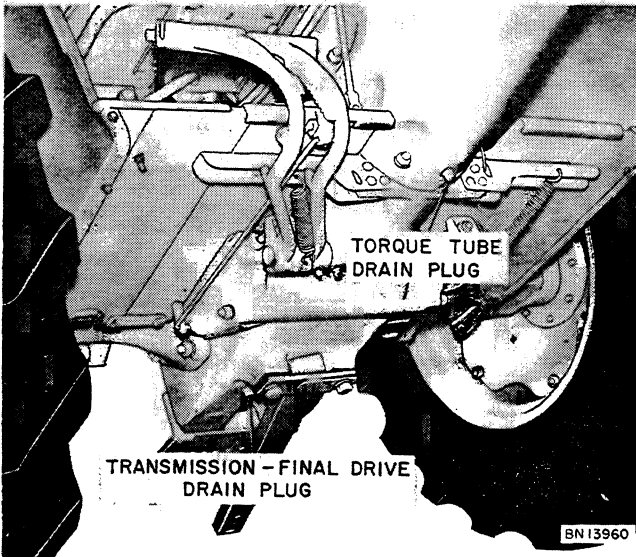

Figure 12 - Transmission and Torque Tube Drain Plugs

TRANSMISSION BREATHER

A transmission housing breather is located at the rear of the transmission case, within the rockshaft housing cover, see Figure 13. This breather allows filtered air to enter or be withdrawn from the case to compensate for temperature changes.

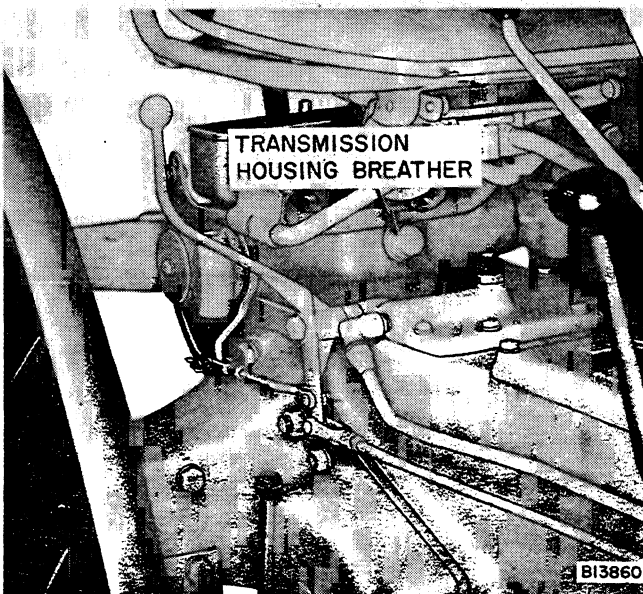

Figure 13 - Transmission Breather

INDEPENDENT P.T.O.

Recommended Lubricant Automatic Transmission Fluid, Type "A"
Oil Capacity 1 U. S. Quart

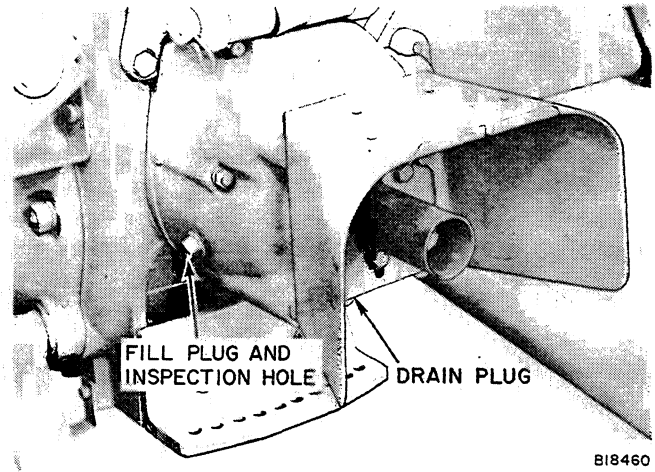

Figure 14 - P.T.O. Lubrication

CHECKING OIL LEVEL

Every 50 hours, clean all dirt from around fill plug, see Figure 14. Then remove plug. The oil level should be just even with the lower edge of the hole (with Tractor standing on a level surface).

DRAINING OIL

If a great deal of P.T.O. work has been done, it is advisable to drain, flush, and refill the P.T.O. housing yearly. The drain plug is located at the bottom of the housing, see Figure 14.

REAR MOUNTED BELT PULLEY

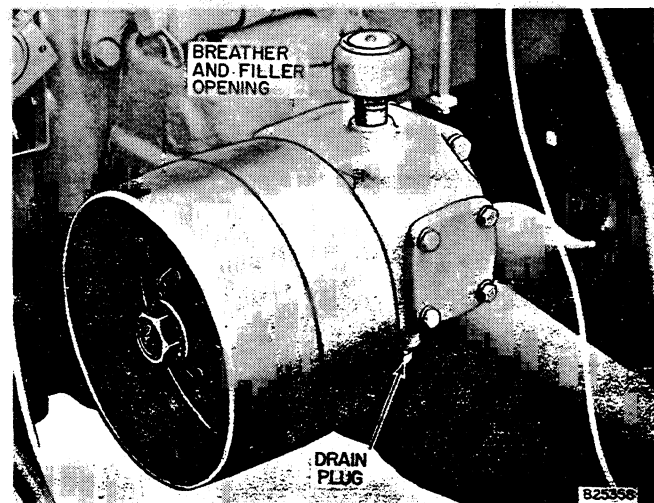

Figure 15 - Belt Pulley Lubrication

Oil Recommendations No. 90 EP Multi-Purpose Type Oil
 Oil Capacity 1 U. S. Pint

The belt pulley housing contains its own oil reservoir. It is advisable to change this oil yearly — or more often if much belt work is being done. Remove the drain plug at the bottom of the housing, see Figure 15.

While the oil is draining, remove and clean the breather element, see Figure 15.

POWER STEERING

Oil Recommendations Automatic Transmission Fluid, Type "A"
 Capacity Approximately 1 U. S. Quart

LUBRICATION — PRESSURE

Everytime Tractor chassis is lubricated (every 10 hours of operation) be sure to give cylinder valve two shots of lubricant, see Figure 16.

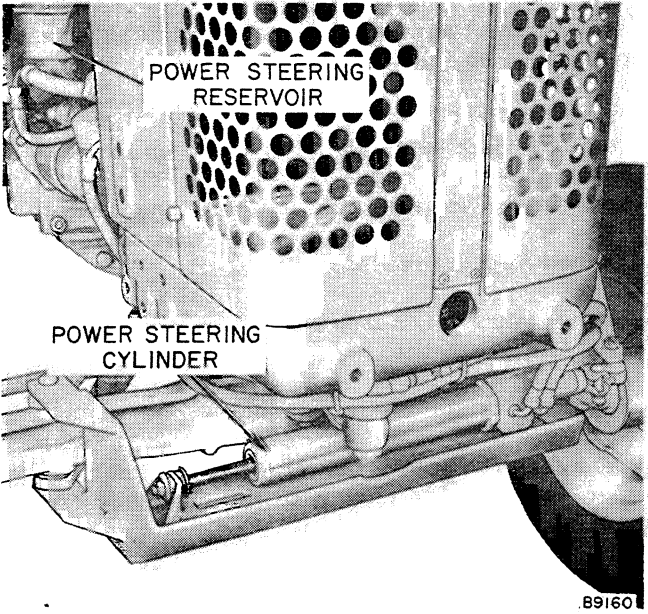

Figure 16 - Power Steering Cylinder

CHECKING OIL LEVEL

Check the oil level after every 50 hours of operation. Be sure to wipe the cover clean before removing. Keep the oil level one inch from top of bowl. A replaceable filter element is provided in the reservoir, see Figure 17. After 1000 hours of operation, or more often in extremely dusty conditions, replace this filter with a new one.

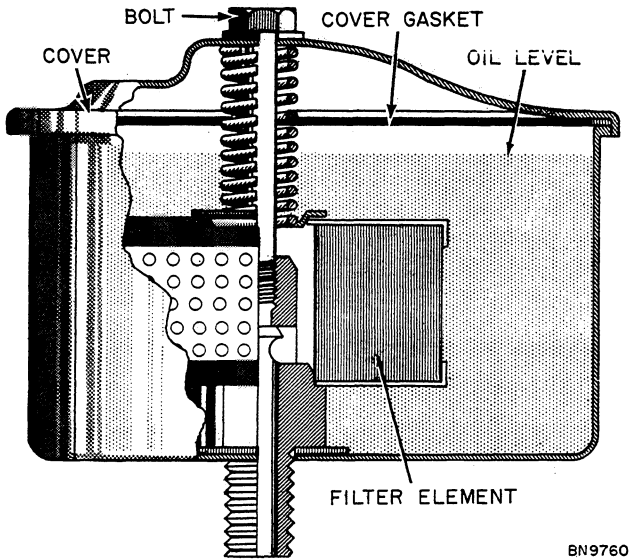

Figure 17 - Power Steering Reservoir

To replace filter, unscrew cap screw, remove cover, and extract the filter, see Figure 17. Be careful not to damage the cover gasket. Install new element, either end up, and be sure it is seated properly. When cover is replaced, be sure the bolt spring holds element firmly down on its seat. This is absolutely necessary to prevent entry of dirt under filter.

If this hydraulic system is kept clean, it should never be necessary to replace the hydraulic fluid.

Check all hose fittings for oil leaks and tighten just enough to prevent oil loss.

TORQUE CONVERTER

A common reservoir in the Tractor torque tube is used for both the Torque Converter Drive and the Eagle Hitch or Remote Hydraulics systems, if the Tractor is so equipped.

HYDRAULIC OIL RECOMMENDATIONS

With high precision and complex hydraulic pumps and systems, the choice of a superior hydraulic oil is the key to long life and low maintenance. In cooperation with one of the leading refineries, the Case Hi-Lo TCH Oil has been developed as a scientific answer to the protection of these finely machined components.

This non-foaming oil is for all season use — remains stable from -55° F to +230° F. Central Parts Division in Racine has this oil in stock. It is recommended as the best oil available for use in the Model "W3" Tractor's torque converter and hydraulic systems.

Torque Tube Reservoir

Refill Capacity 16 U. S. Quarts
Alternate Oil Recommendations . . . Heavy-Duty
Motor Oil meeting American Petroleum In-
stitute (A.P.I.) service designation, MS-
DG. Only a good grade oil, with non-
foaming characteristics should be used.

Viscosity Recommendations

(Above 0° F) SAE 10W
(Below 0° F) SAE 5W

CHEAP GRADES OF OIL ARE NOT SUITABLE FOR USE
IN HYDRAULIC SYSTEMS.

OIL VISCOSITY

If Case Hi-Lo TCH Oil for all season use is not
used, be sure to follow the viscosity recommenda-
tions for the alternate oil — MS-DG service designa-
tion motor oil.

CHECKING HYDRAULIC OIL LEVEL

It is extremely important that the proper oil level
be maintained. Too high an oil level will cause
"flooding" of the flywheel housing, loss of power,
and overheating of oil. Too low an oil level will
result in inefficient operation and damage to the
Torque Converter Drive and/or the hydraulic system.

To check the oil level, proceed as follows:

1. Drive Tractor onto a level surface.
2. Before checking the oil level, allow the Tractor
engine to run until the oil is up to operating tem-
perature. Also have the Eagle Hitch (if used)
draft arms raised and any other hydraulic cylinder
(if used) with piston rod extended.

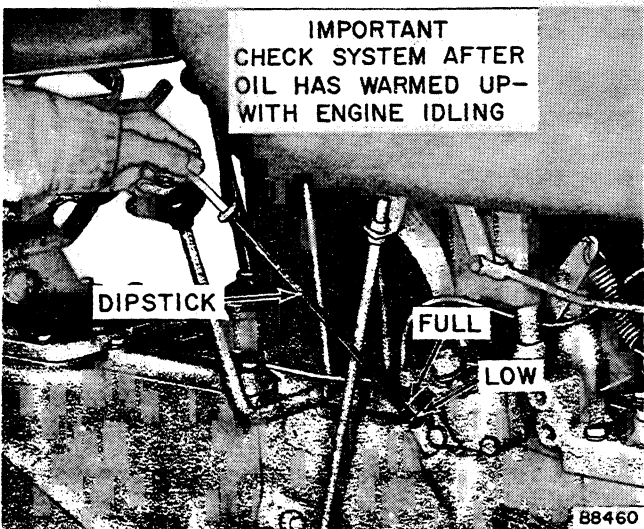

Figure 18 - Checking Torque Converter Oil Level

3. Place the Shuttle Shift lever in neutral position
and have the engine IDLING. Check the oil level
with the dipstick, see Figure 18. The most accu-
rate reading will be made if the dipstick is held
with the curved top toward the rear, then insert-
ed and withdrawn very rapidly. This will mini-
mize the chance of oil being thrown on the dip-
stick by gears.

If necessary, add sufficient Case Hi-Lo TCH
Oil to bring the level to the "FULL" mark on the
dipstick. DO NOT OVERFILL — this results in a
"sluggish" Tractor.

If the reservoir is low, the Torque Converter
Drive may act erratically. This condition is
usually worse with the Tractor going up or down
a hill due to the oil in the reservoir being beyond
the reach of the suction tube on the oil pump.

4. Replace fill plug and tighten securely.

DRAINING HYDRAULIC OIL

The hydraulic oil must be drained after every 1000
hours operation or once a season, whichever occurs
first.

To drain the torque tube reservoir and converter
unit, proceed as follows:

1. Drive the Tractor onto a level surface. Allow the
Tractor engine to run until the oil is up to oper-
ating temperature. Place the Eagle Hitch draft
arms in the lowered position (with the control
valve in the neutral position) so that all oil is
drained from the rockshaft cylinder.
2. Remove two (2) 1/2 inch pipe plugs, see Figure
19. Allow the oil to drain for several minutes.
3. Have an assistant turn the engine over slowly
while you observe the lining up of plug "A" with
the front drain hole in the torque tube. Then use
a 3/16 inch Allen wrench to remove plugs "A"
and "B".

CAUTION: BE EXTREMELY CAREFUL NOT TO LOSE
EITHER OF THESE PLUGS OFF THE END OF THE
ALLEN WRENCH WHEN EXTRACTING THEM FROM
HOLES IN THE BOTTOM OF THE TORQUE TUBE.

Allow all oil to drain out.

CAUTION: NEVER, UNDER ANY CONDITIONS, RUN
THE TRACTOR ENGINE WITH OIL REMOVED FROM
TORQUE TUBE RESERVOIR. THIS COULD DAMAGE
THE HYDRAULIC PUMP IN A FEW SECONDS TIME.

4. Replace both the Torque Converter Drive and
Eagle Hitch (if used) filter elements.

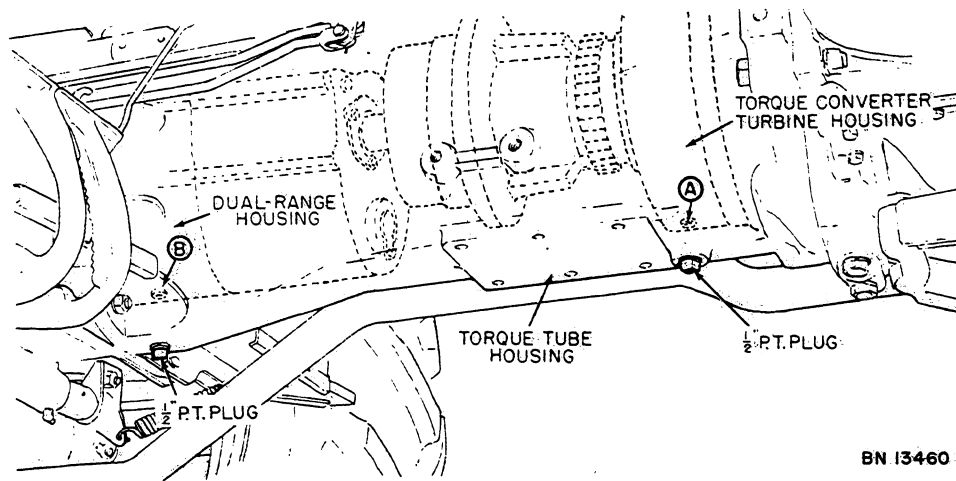

BN 13460

Figure 19 - Torque Tube Drain Plugs

5. Replace pipe plugs "A" and "B". If pipe plug "A" has been inadvertently left out of the converter drum, the Tractor will have a strong tendency to move, even with the foot pedal depressed. Also gear shifting will be very difficult due to gears clashing. This condition is the result of insufficient converter pressure to disengage the multiple disc clutch.
6. Replace two (2) 1/2 inch pipe plugs.
7. Add 16 U. S. quarts of Case Hi-Lo TCH Oil or approved substitute to the reservoir.
8. Start Tractor engine, allow to run for several minutes, and then check oil level with dipstick WITH ENGINE IDLING.
9. Check filter housing(s) for oil leaks.

tion OR MORE OFTEN WHEN OPERATING IN EXTREMELY DUSTY CONDITIONS. See Figure 20 for location of breather; see Figure 9 in Section IV for exploded view of breather. The filter element should be blown dry with compressed air — if damaged the element must be replaced.

Failure to keep the breather clean may result in a pressure build-up in the reservoir, thus, forcing oil past the oil seals and gaskets.

SERVICING OIL FILTER

The importance of changing the Torque Converter Drive oil filter element cannot be overemphasized. The life of the entire system depends a great deal on the cleanliness of the oil. Dirt and foreign matter are the No. 1 enemy of the Torque Converter Drive system. If cleanliness precautions are not followed, trouble will soon develop.

RESERVOIR BREATHER

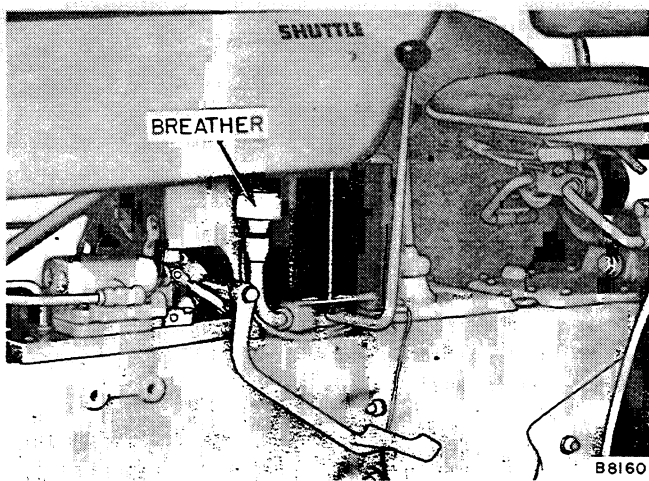

Figure 20 - Torque Tube Breather

This breather should be removed, disassembled and cleaned in solvent after every 200 hours opera-

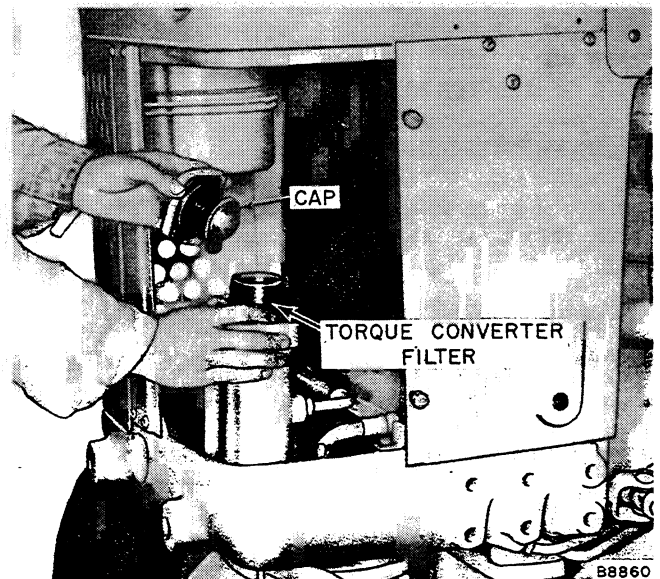

Figure 21 - Changing Torque Converter Oil Filter

IMPORTANT: IF THE TRACTOR IS EQUIPPED WITH AN EAGLE HITCH OR REMOTE HYDRAULICS ANOTHER FILTER ELEMENT IS LOCATED ABOVE THE TORQUE TUBE. Because the Torque Converter Drive and Eagle Hitch — Remote Hydraulics systems utilize a common reservoir in the torque tube, both filter elements must be replaced at the same time interval.

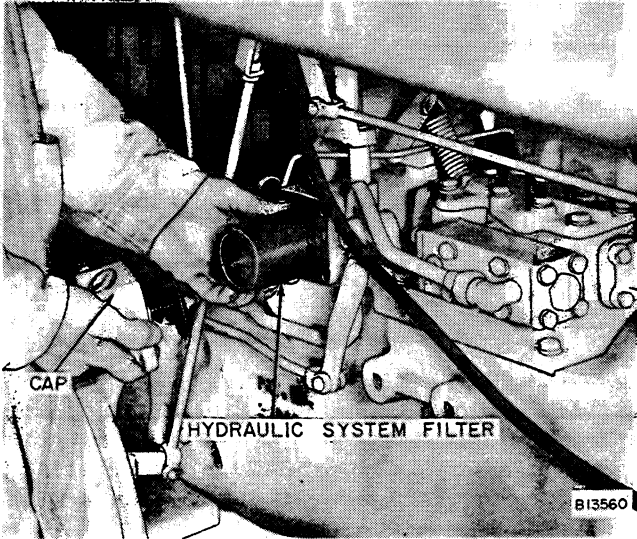

Figure 22 - Changing Hydraulic System Filter

PASS THIS INFORMATION ON TO THE OPERATOR: Replace the filter element(s) after the first 20 hours of operation and every 200 hours thereafter on new units. Follow these same precautions on Tractors which have had service work performed on the Torque Converter or any part of the torque tube, regardless of the number of hours on the unit.

All of the oil in the Torque Converter Drive system is circulated through the oil filter. If dirt collects in the filter, it will act as a restriction. The filter is spring loaded, see Figure 23. When the oil is cold and too heavy or the filter element is plugged, the oil will bypass the element. **THUS, THE OIL WILL CIRCULATE WITHOUT FILTRATION. THIS WILL CAUSE PREMATURE FAILURE OF THE TORQUE CONVERTER SYSTEM.**

IN AN EMERGENCY, the same filter element could be replaced, **PROVIDING** it was cleaned in mineral spirits or some solvent that would evaporate. However, this is for **TEMPORARY** usage and a **NEW FILTER ELEMENT** must be secured immediately.

NOTE: Whenever the Torque Converter Drive filter element is replaced, also be sure to clean the housing.

REMOVING FILTER ELEMENT

To remove the filter element, proceed as follows:

1. Remove four cap screws from the filter housing.

2. If necessary to loosen, tap the cap **LIGHTLY**. Remove cap and lift filter element out of the housing. The flow of oil through the element is from the inside to the outside. Thus, most of the dirt and foreign matter will have collected on the inside of the element.

SERVICING HOUSING

In some instances where the filter has not received the proper attention, it may be necessary to break the filter element to remove it from the housing.

Always examine the bottom of the housing for dirt or foreign matter. If this condition exists, remove inlet (bottom) line and outlet (top) line from the housing. Then remove mounting cap screws and lift the housing from the Tractor.

Thoroughly clean filter housing, making absolutely certain all dirt and foreign matter are removed from the inside and especially the bottom. **DO NOT USE LINTY CLOTHS TO CLEAN THE HOUSING.**

After the housing has been thoroughly cleaned, reinstall on the Tractor.

INSTALLING FILTER ELEMENT

To install replacement filter element, proceed as follows:

1. Install new filter element, making certain it is properly seated in the bottom of the housing.
2. Position the cap with retainer spring, over the filter element.
3. To prevent oil leakage, make sure the rubber "O" ring for the cap is in place and not damaged, see Figure 23.

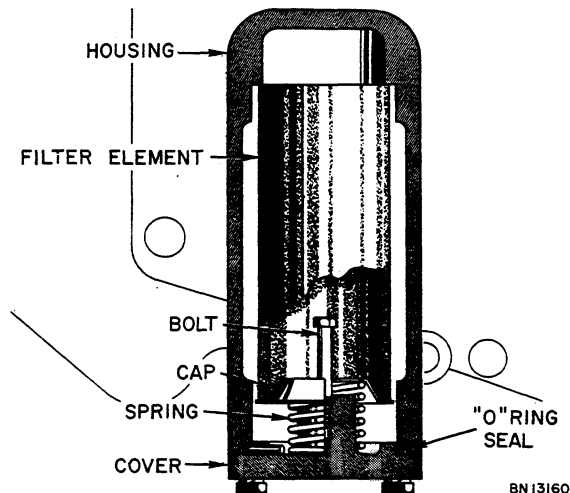

Figure 23 - Cross Sectional View of Filter

4. Install four cap screws in the housing cap and tighten them evenly in increments of 5 ft. lbs. torque until 20 ft. lbs. is reached.
5. Run the Tractor engine until the hydraulic oil is up to operating temperature. Then check around the filter for leakage.

IMPORTANT: IF THE TRACTOR IS EQUIPPED WITH AN EAGLE HITCH OR REMOTE HYDRAULICS ANOTHER FILTER ELEMENT IS LOCATED ABOVE THE TORQUE TUBE. Because the Torque Converter Drive and Eagle Hitch — Remote Hydraulics systems utilize a common reservoir in the torque tube, both filter elements must be replaced at the same time interval.

5. FUEL SPECIFICATIONS (GASOLINE)

Case Gasoline Engines are designed to operate on regular-grade gasoline. The anti-knock quality of regular-grade gasoline, as indicated by its octane numbers, will give full power and economy together with long engine life and low maintenance costs. Third-grade gasoline should not be used. Knock or detonation resulting from a lack of anti-knock quality may cause premature failures of engine parts, such as cylinder head gaskets, valves, pistons, and spark plugs. Also, third-rate gasoline will not give full power and economy.

The average octane number ratings for regular-grade gasoline (October 1957) are 83.5 motor method

and 90.7 research method. Case engines are designed to operate on gasoline having a minimum research method rating of 90.7 octane.

Two octane number ratings, motor method and research method, are used to define the anti-knock quality of a gasoline. In recent years it has become common practice in the petroleum industry to refer only to the research method rating rather than the motor method rating. Therefore, when only one octane number rating is given for a gasoline and the method is not specified, it can be assumed to be the research rating.

6. FUEL SPECIFICATIONS (DIESEL)

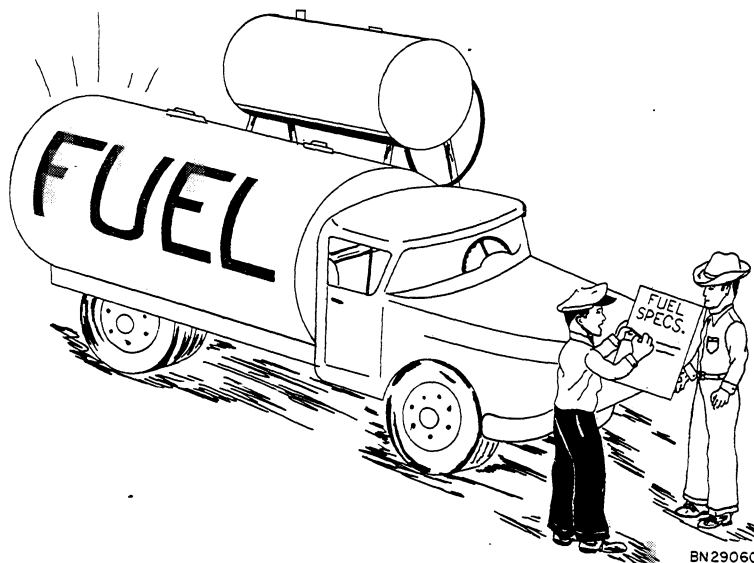

This Case Diesel Engine is designed to operate most efficiently when using a NUMBER 2 DIESEL FUEL. Most well-known refiners and distributors market a good grade Diesel fuel and there should be no difficulty in obtaining same.

ATTENTION: DO NOT CONFUSE NUMBER 2 DIESEL FUEL WITH NUMBER 2 FURNACE OIL, AS FURNACE OIL DOES NOT ALWAYS MEET THE FUEL SPECIFICATIONS FOR DIESEL ENGINES.

These are specifications for a suitable Diesel fuel:

A.P.I. Gravity	32-39
POUR POINT	A rating 10° Lower than the Lowest Anticipated Temperatures
Volatility	
Initial Boiling Point (Minimum)	320° F
50% Condensed	475°-550° F
Final Boiling Point (Maximum)	675° F
Distillation Recovery (Maximum)	97%
Flash Point	Legal Minimum Limit or Higher
S.U. Viscosity at 100%	34-39 Seconds
CETANE (Minimum)	45 (45-55 for winter use)
Diesel Index	43
Water and Sediment (Maximum)	0.05%
Ash (Maximum)	0.02%
TOTAL SULPHUR (Maximum)	0.4%
Conradson Carbon	0.2%
Copper Strip Corrosion	Pass
Alkali and Mineral Acid	Neutral

The use of Number 1 Diesel Fuel, which is a lighter fuel, may result in a loss of engine power and also increases fuel consumption, since it has less heat content and a lower viscosity than Number 2 Diesel Fuel. The life of the injection pump may also be affected due to the lack of lubricant in the lighter Number 1 Diesel Fuel.

**PROTECT YOUR FUEL SYSTEM!
BUY CLEAN FUEL
AND
KEEP IT CLEAN!**

FUEL SPECIFICATION DEFINITIONS

The definitions of the following terms used in describing the fuel specifications, will be useful for reference when selecting a suitable Diesel fuel.

POUR POINT

Pour point is especially important for cold weather operation because:

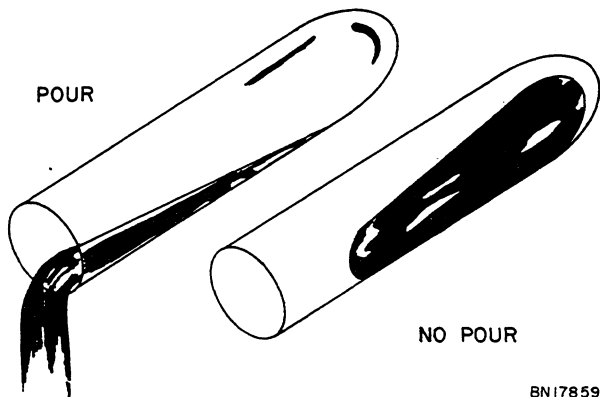

BNI7859

1. If the prevailing air temperatures are lower than the fuel pour point, the engine will not start simply because the fuel will not flow through the fuel system.
2. The highly precision injection pump and injector parts receive their lubrication from the Diesel fuel. If the fuel is not fluid, serious damage may occur due to lack of lubrication.
3. Use the Diesel fuel that has a pour point rating at least 10° F lower than the coldest anticipated temperature. At approximately 10° F above the pour point, waxes, etc., in the fuel start to congeal and will clog filters.

CETANE RATING

The Cetane Rating is the self-igniting quality of a Diesel fuel. Do not apply Cetane Rating to Diesel engine performance as it would apply to gasoline octane rating to spark ignition engine performance. High Cetane Ratings do not necessarily provide for improved Diesel engine performance.

A Cetane Rating number of 40 is considered low, while a Cetane Rating of 60 is considered high. Your Case Diesel Engine is designed to operate most efficiently with a Number 2 Diesel Fuel having a minimum Cetane Rating of 45 (45 to 55 in cold weather). Number 1 Diesel Fuel with higher Cetane Ratings are not recommended because:

1. Premium Diesel Fuels are higher in price, but will not materially increase engine performance and therefore result in high operating costs.
2. Number 2 Diesel Fuels with a Cetane Rating of 45 to 50 are widely distributed and are more readily available.

SULPHUR

Sulphur content is the percentage of corrosive sulphur in the Diesel Fuel.

A high sulphur content (above 0.4%) in Diesel Fuel is always undesirable, but it is especially harmful when the engine must be operated in cold weather, intermittently, or with varying loads where it is difficult to keep operating temperature up to the recommended level. These types of operations result in moisture condensation in the engine which unites with the sulphur to form destructive acids. High sulphur content in the fuel will cause:

1. Excessive engine wear;
2. Formation of harmful deposits on valves, rings, pistons, and cylinder sleeve walls;
3. Possible corrosive damage to the fuel system.



EXTRA HEAVY DUTY MOTOR OIL: To keep the engine free of harmful deposits and to counteract any destructive acids that may be formed, an "Extra Heavy Duty", additive-type, crankcase oil must be used. Use a good grade crankcase oil meeting A.P.I. service designation DS (Series 3) under all types of operating conditions.

ASH

Ash is the percentage of harmful non-combustible material in the Diesel fuel. A fuel containing a higher maximum ash content than 0.01% can damage the extremely close fitting parts in the fuel injection system.

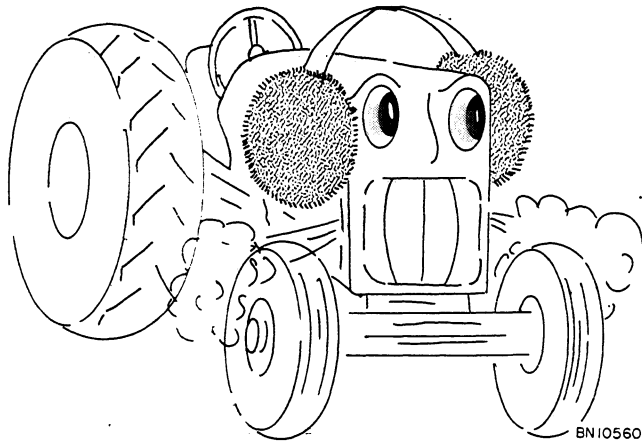

FUEL RECOMMENDATIONS FOR COLD WEATHER OPERATION

If the engine is to be operated during cold weather, special fuel system precautions should be observed as to the: (1) POUR POINT; (2) CETANE RATING; (3) SULPHUR CONTENT; and (4) WATER CONTENT of the Diesel Fuel.

POUR POINT: Use Diesel Fuel that has a pour point rating of at least 10° F lower than the coldest anticipated temperature. At approximately 10° F above the pour point, waxes, etc., in the fuel start to congeal and will clog filters.

CETANE RATING: The Cetane Rating must be at least 45 to 55 for most efficient cold weather starting.

SULPHUR CONTENT: A high sulphur content in the fuel is especially injurious to the engine when it is operated intermittently or with the coolant temperature below the recommended operating temperature. The moisture condensation that forms during cold weather operation, combines with the sulphur in the fuel to form corrosive acids which attack the finely machined surfaces. To eliminate possible acid damage: (1) Use Diesel Fuel with a sulphur content of 0.4% or less; (2) Keep engine operating temperature up to recommended level; (3) Always use Service DS (Series 3) Motor Oil.

WATER CONTENT: Special precautions must be taken to prevent the entry of water into the fuel system:

1. Always refill the fuel tank at the end of each day's operation to prevent water condensation inside the tank;
2. The drain on the filter should be opened daily before starting the engine to remove any accumulated water.
3. Fuel must be allowed to settle in storage for at least 24 hours before putting it into the Tractor's fuel tank.

FUEL HANDLING AND STORAGE

The handling of Diesel Fuel presents a special problem because the specific gravity of this fuel is relatively close to that of water, abrasive rust, and dust particles. This allows these contaminants to remain in suspension in the fuel for long periods of time. For this reason, Diesel fuel must be allowed to settle for at least 24 hours without being disturbed in any way, before it is put into the fuel tank.

Fuel should always be strained or filtered before being put into the storage tank — it is easier and much cheaper to remove dirt from the fuel BEFORE it finds its way into the engine fuel system.

The storage tank should be constructed of rust proof steel, with a provision for removal of accumulated sludge and water. This must be done at regular 10 day intervals.

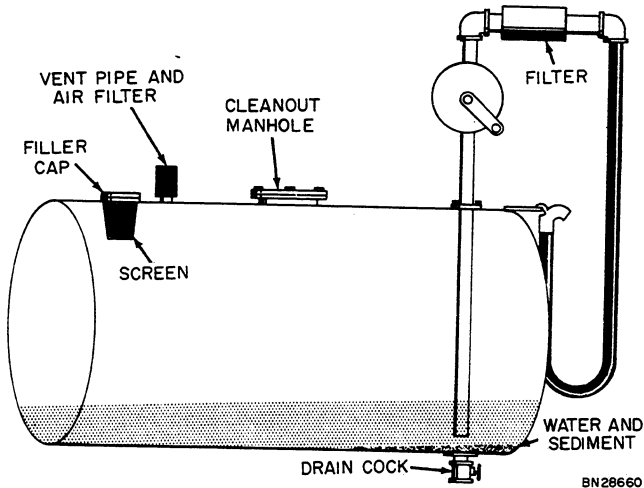

In addition, the fuel should be filtered between the storage tank and the dispensing hose. Double filtering is preferred. The filtering equipment must be maintained as recommended by the manufacturer.

Use a rust proof storage tank similar to the illustration above. This tank should be equipped with a pump, so the Diesel fuel can be transferred directly from the storage tank to the Tractor fuel tank.

The hose from the pump should be equipped with a nozzle, so the contamination of the fuel by the use of dirty buckets or funnels can be eliminated.

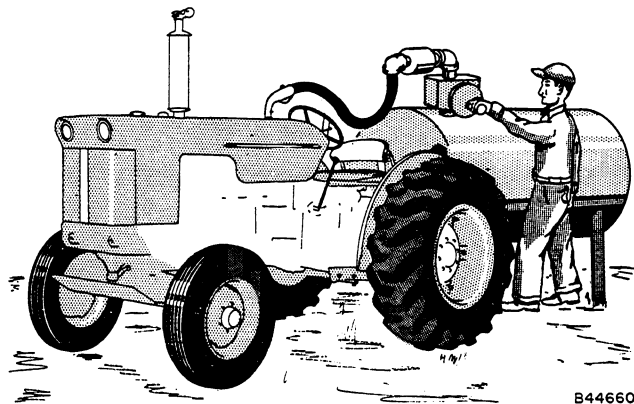

Allow the fuel to settle during the night, so that contaminants will be drained off each morning when the sediment bowl is drained, before starting the day's work. See Figure 24 for location of the filter.

FUEL SYSTEM PRECAUTIONS

1. Fill the Tractor fuel tank at the end of each work day to keep condensation at a minimum.

2. Drain water from sediment bowl EACH MORNING, see Figure 24. In cold weather, drain bowl at end of each day's operation to prevent moisture from freezing in the bowl.

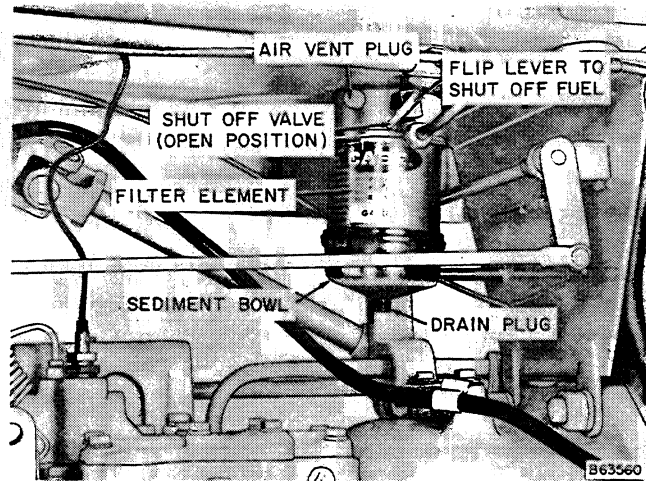
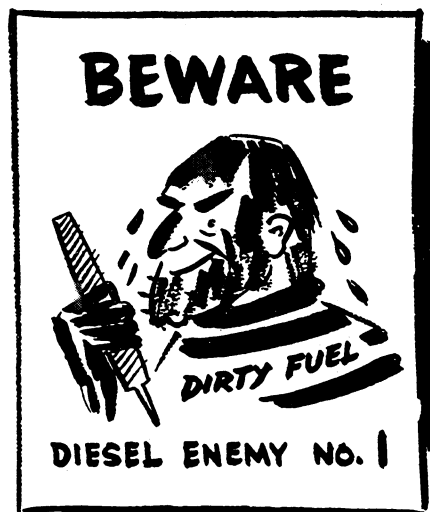

Figure 24 - Fuel Filter (Diesel Engine)

3. Do not use waste or linty rags around fuel containers or fuel injection equipment. CLEAN FUEL IS AN ABSOLUTE "MUST" FOR GOOD DIESEL ENGINE OPERATION.
4. When emptying a drum of fuel oil, agitate it as little as possible and leave about one inch of fuel in the bottom of the drum, which may contain sediment or water.



CLEANING FUEL STORAGE TANKS

Drain all remaining fuel from the tank. Use a mixture of one part alcohol and one part benzol, or use acetone to dissolve the deposits in the tank. Flush the tank with clean, fresh Diesel fuel.

The temperature of the fuel during storage affects the formation of gum and varnish. Fuel that is stored in a warm place or where the sun directly strikes the tank will form gum more rapidly than fuel stored in a cool place where the temperature remains constant.

GUM AND VARNISH FORMATION IN FUEL

Most Diesel fuel is refined by a "cracking" process and has a natural tendency to form gum or varnish when stored. Most major fuel refiners and distributors add a "gum inhibitor" which retards the formation of gum and allows it to be stored for longer periods.

Gum or varnish in Diesel fuel plugs the fuel filtering system and interferes with the operation of closely fitted parts in the Fuel Filtering System of a Diesel Engine.

Gum and varnish will result in power loss, misfiring, and other symptoms that can easily be mistaken for mechanical difficulty. This would result in unnecessary, expensive servicing of the Diesel Injection System, which would provide only temporary relief.

FUEL CONDITIONER

In areas where gum and varnish in the fuel presents a problem, it is recommended that "Case Diesel Fuel Conditioner" be used. This conditioner acts as a detergent or solvent and can be used to

clean out gum and varnish deposits already in an engine and, when used regularly, will prevent those deposits from forming.

The following "Case Diesel Fuel Conditioner" recommendations are made for areas troubled with gum or varnish in the fuel:

1. Add conditioner to the fuel in the main tank, or;
2. Add a small quantity of conditioner to the fuel tank daily, or;
3. Use conditioner periodically or at the first sign of symptoms developing in the engine that indicates gum and varnish deposits in the fuel injection system.

CASE DIESEL FUEL CONDITIONER is available in 32 ounce cans from Central Parts Division in Racine.

Refer to the instructions on the container as to the amount and frequency of use.

IMPORTANT

1. BUY DIESEL FUEL IN QUANTITIES THAT WILL BE USED UP IN 90 DAYS OR LESS.
2. PROTECT MAIN STORAGE TANK WITH A SHELTER SO THE FUEL CAN BE KEPT AS COOL AS POSSIBLE.
3. WHEN THE ENGINE IS TO REMAIN IDLE FOR A MONTH OR LONGER, FOLLOW THE ENGINE STORAGE SECTION INSTRUCTIONS AS GIVEN IN THE OPERATOR'S INSTRUCTION MANUAL.

GROUP B - SPLITTING TRACTOR

1. REMOVING BACKHOE

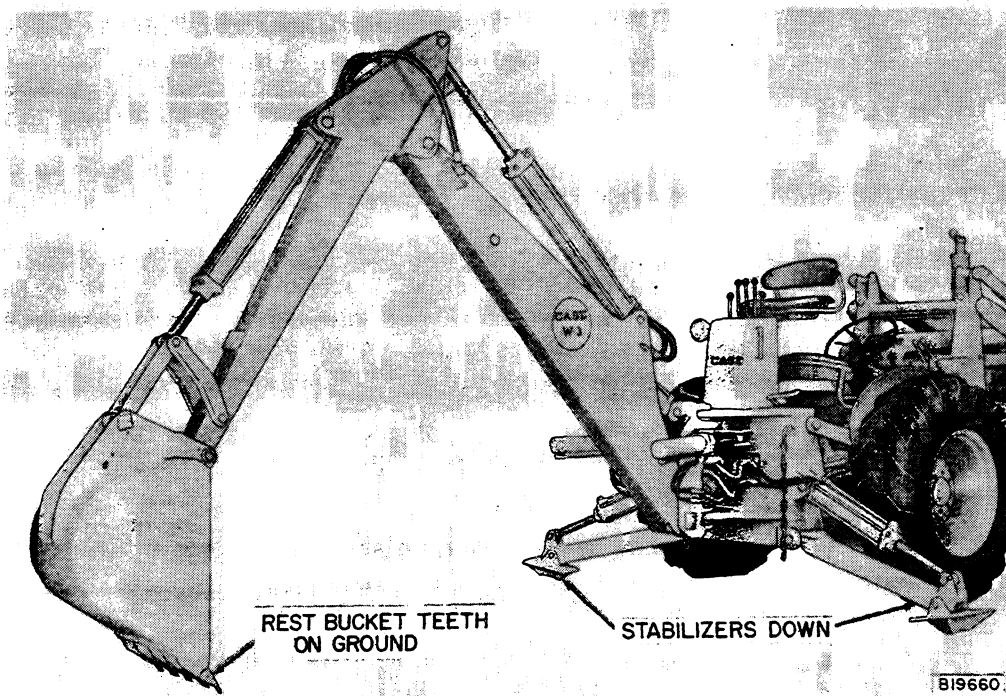

Figure 25 - Backhoe Forming a Tripod

To remove the Backhoe, proceed as follows:

1. Have the unit on a level spot, preferably on concrete or other hard surface.
2. Start the Tractor engine and use control levers to form a "tripod" with the Backhoe, as shown in Figure 25. Lower stabilizers, exerting enough "down-pressure" to take all the weight of the Backhoe from the Tractor.

3. REFERRING TO FIGURE 26: Remove bolts "A" and loosen bolts "B".

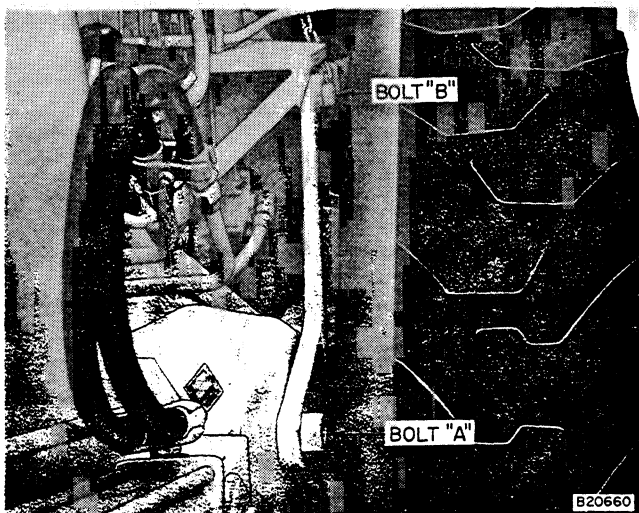

Figure 26 - Bolts to be Removed

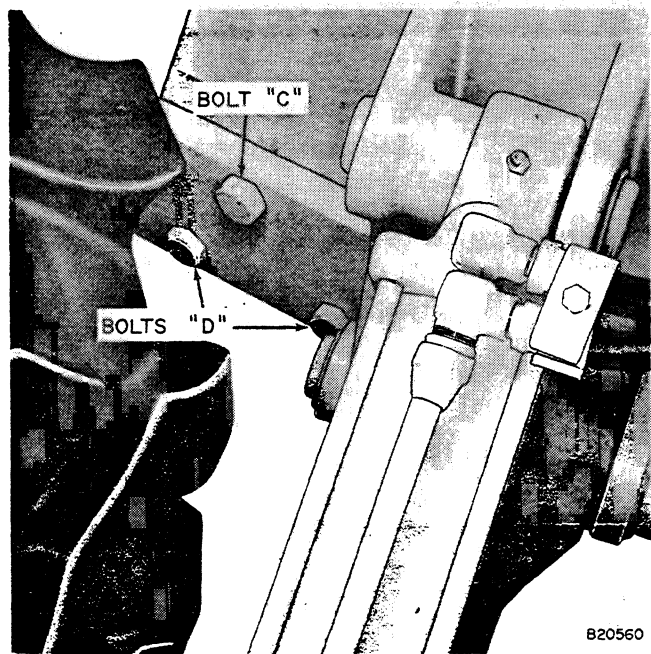

Figure 27 - Bolts to be Removed

4. REFERRING TO FIGURE 27: Remove mounting bolts "C" and "D".



Suggest:

If the above button click is invalid.

Please download this document

first, and then click the above link

to download the complete manual.

Thank you so much for reading

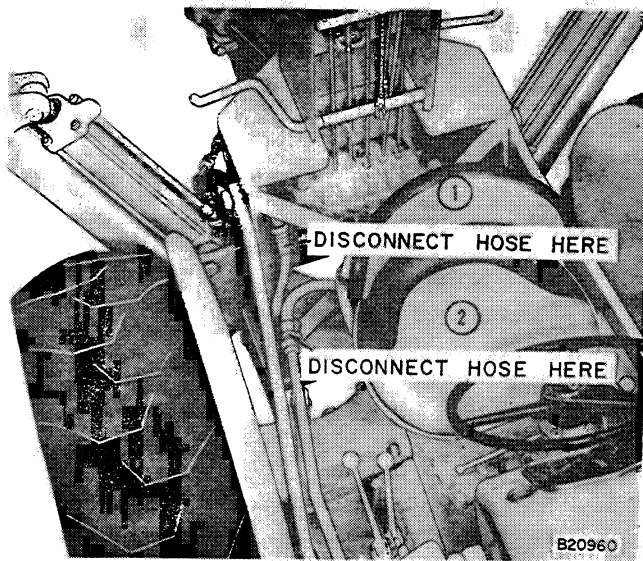

Figure 28 - Hose Connections

5. REFERRING TO FIGURE 28: Disconnect hose at valve and return hose at tube. Connect pressure hose to return tube to complete the circuit, see Figure 30.
6. Disconnect the tail light wire at the pull coupling. Remove the tail light from the valve shield and install on fender (if unit is to be operated). Connect tail light to Tractor wiring harness.

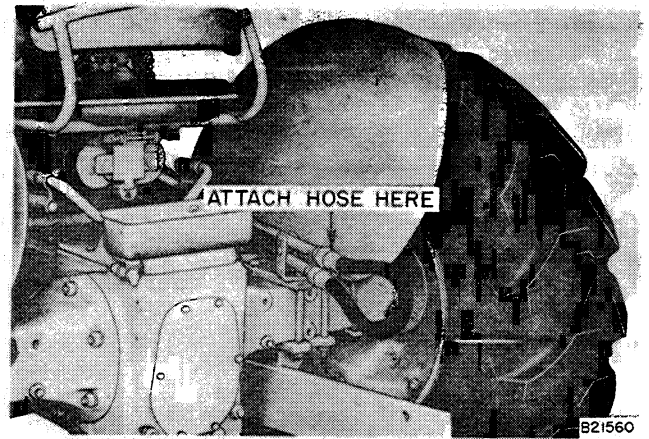

Figure 30 - Hose Connections at Tractor

7. The Tractor can be driven away from the Backhoe.
8. Connect loose end of hose on Backhoe to valve inlet port, see Figure 29. Place blocks under Backhoe near pivot end of stabilizers.

REINSTALLING BACKHOE

Refer to Figures 26, 27, 28, 29, and 30.

1. Clean all accumulated dirt from around hoses and fittings.

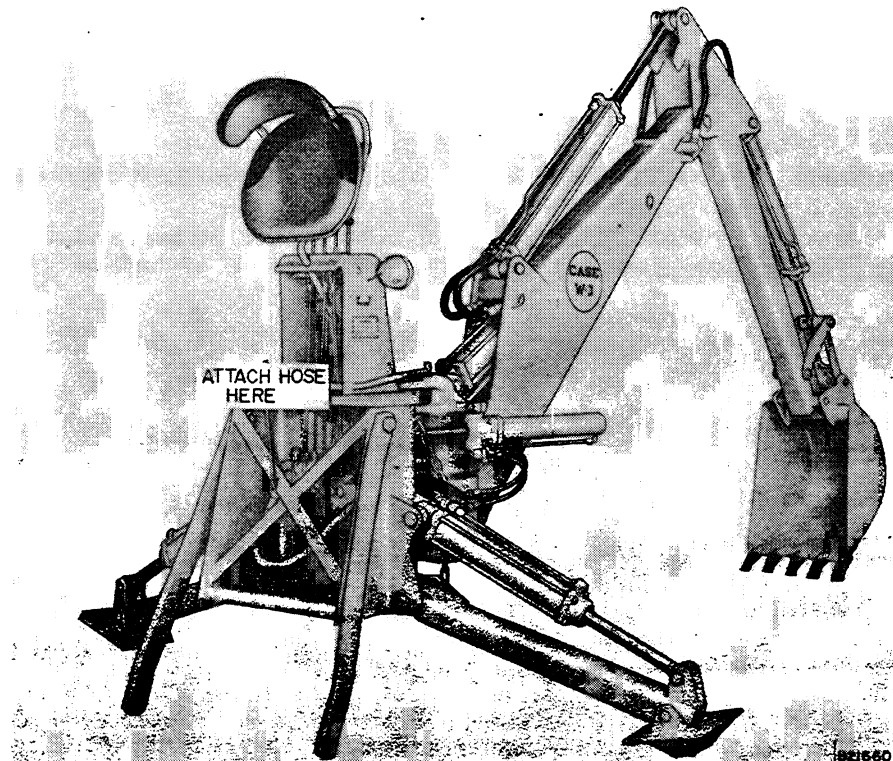

Figure 29 - Backhoe Off Tractor

<https://www.ebooklibonline.com>

Hello dear friend!

Thank you very much for reading.

Enter the link into your browser.

The full manual is available for immediate download.

<https://www.ebooklibonline.com>