

9020 Excavator Service Manual

Table of Contents

Description	Section No.	Form No.
General		
	Tab 1	
Section Index - General		7-45990
Standard Torque Specifications for 9000 Series Excavators	1001	7-44790
Fluids and Lubricants	1002	7-45590
Engines		
	Tab 2	
Section Index - Engines		7-46000
Engine Removal and Installation	2001	7-46700
Radiator Removal and Installation	2002	7-46710
Detailed Engine Specifications	2402	8-24163
Aftercooler	2411	7-43510
Cylinder Head and Valve Train	2415	8-24173
Cylinder Block	2425	8-24183
Lubrication	2445	8-24193
Cooling System	2455	8-24203
Turbocharger	2465	8-25550
Turbocharger Failure Analysis	2565	9-78235
Fuel System		
	Tab 3	
Section Index - Fuel System		7-46010
Fuel System and Filters	3410	8-24212
Fuel Injectors	3413	8-24233
Fuel Injection Pump (Bosch)	3415	7-37141
Electrical		
	Tab 4	
Section Index - Electrical		7-46020
Electrical Specifications and Troubleshooting	4001	7-45770
Electric Schematic Foldout	In Rear Pocket	7-45970
Batteries	4002	7-44950
Systems Display Panel	4005	7-44980
Starter and Starter Solenoid	4006	8-42191
Alternator	4009	8-16570
Tracks		
	Tab 5	
Section Index - Tracks		7-46030
Troubleshooting the Track System	5001	7-44830
Tracks, Rollers, and Idlers	5002	7-46040
Power Train		
	Tab 6	
Section Index - Power Train		7-46050
Troubleshooting - See Section 8001		
Drive Motor and Final Drive Transmission	6000	7-46060

Reprinted



9020 Excavator Service Manual

Table of Contents

Description	Section No.	Form No.
Hydraulics		Tab 8
Section Index - Hydraulics		7-46070
Cleaning the Hydraulic System	8000	7-45050
Hydraulic Specifications, Troubleshooting, and Pressure Checks	8001	7-45850
Hydraulic Schematic Foldout	In Rear Pocket	7-45970
Main Hydraulic Pump	8002	7-46080
Pilot Control Circuit Pump	8003	7-46090
Hydraulic Swivel	8004	7-46100
Main Control Valve	8005	7-46110
Remote Control Valves	8006	7-45780
Solenoid Valves	8007	7-46960
Swing Motor and Swing Reduction Gear Box	8008	7-46120
Cylinders	8009	7-46130
Cushion Control Valve	8010	7-46750
Boom Holding Valve	8011	7-46780
Auxiliary Control Valve	8012	7-46790
Mounted Equipment		Tab 9
Section Index - Mounted Equipment		7-46140
Pedals and Levers	9001	7-45670
Turntable Bearing	9003	7-46720
Boom and Arm	9004	7-46150
Seat and Seat Belts	9006	7-45170
Electric and Hydraulic Schematic Foldout	In Rear Pocket	7-45970

SECTION INDEX - GENERAL

Section Title

Section Number

Standard Torque Specifications for 9000 Series Excavators	1001
Fluids and Lubricants	1002



<https://www.ebooklibonline.com>

Hello dear friend!

Thank you very much for reading.

Enter the link into your browser.

The full manual is available for immediate download.

<https://www.ebooklibonline.com>

Section 1001

STANDARD TORQUE SPECIFICATIONS FOR 9000 SERIES EXCAVATORS



Bur 7-44790

Copyright © 1992 CASE CORPORATION
Printed in U.S.A.
Issued November 1992

TABLE OF CONTENTS

TORQUE SPECIFICATIONS - DECIMAL HARDWARE2

TORQUE SPECIFICATIONS - METRIC HARDWARE3

TORQUE SPECIFICATIONS - STEEL HYDRAULIC FITTINGS4

TORQUE SPECIFICATIONS - O-RING FACE SEAL FITTINGS5

TORQUE SPECIFICATIONS - DECIMAL HARDWARE

Use the torques in this chart when special torques are not given. These torques apply to fasteners with both UNC and UNF threads as received from suppliers, dry, or when lubricated with engine oil. Not applicable if special graphites, molydisulfide greases, or other extreme pressure lubricants are used.

Grade 5 Bolts, Nuts, and Studs		
		
Size	Pound-Feet	Newton metres
1/4 in	9-11	12-15
5/16 in	17-21	23-28
3/8 in	35-42	48-57
7/16 in	54-64	73-87
1/2 in	80-96	109-130
9/16 in	110-132	149-179
5/8 in	150-180	203-244
3/4 in	270-324	366-439
7/8 in	400-480	542-651
1.0 in	580-696	787-944
1-1/8 in	800-880	1085-1193
1-1/4 in	1120-1240	1519-1681
1-3/8 in	1460-1680	1980-2278
1-1/2 in	1940-2200	2631-2983

Grade 8 Bolts, Nuts, and Studs		
		
Size	Pound-Feet	Newton metres
1/4 in	12-15	16-20
5/16 in	24-29	33-39
3/8 in	45-54	61-73
7/16 in	70-84	95-114
1/2 in	110-132	149-179
9/16 in	160-192	217-260
5/8 in	220-264	298-358
3/4 in	380-456	515-618
7/8 in	600-720	814-976
1.0 in	900-1080	1220-1465
1-1/8 in	1280-1440	1736-1953
1-1/4 in	1820-2000	2468-2712
1-3/8 in	2380-2720	3227-3688
1-1/2 in	3160-3560	4285-4827

NOTE: Use thick nuts with Grade 8 bolts.

TORQUE SPECIFICATIONS - METRIC HARDWARE

Use the following torques when specifications are not given.

These values apply to fasteners with coarse threads as received from supplier, plated or unplated, or when lubricated with engine oil. These values do not apply if graphite or molydisulfide grease or oil is used.

Grade 8.8 Bolts, Nuts, and Studs		
		
Size	Pound-Feet	Newton metres
M6	6-7	8-9
M8	14-17	20-23
M10	29-34	39-46
M12	50-59	68-80
M16	128-149	173-202
M20	249-291	337-393
M22	342-399	464-541
M24	431-503	584-681
M27	637-743	864-1008
M30	863-1007	1170-1365
M33	1180-1377	1600-1867
M36	1977-2307	2680-3127
M42	2434-2840	3300-3850
M45	3054-3563	4140-4830
M48	3658-4268	4960-5787
M52	4757-5549	6450-7525
M56	5908-6893	8010-9345
M64	8925-10413	12100-14117

Grade 10.9 Bolts, Nuts, and Studs		
		
Size	Pound-Feet	Newton metres
M6	8-10	11-13
M8	20-24	28-32
M10	41-47	55-64
M12	71-83	96-112
M16	178-208	242-282
M20	350-408	475-554
M22	481-561	652-761
M24	606-707	821-958
M27	900-1050	1220-1423
M30	1217-1420	1650-1925
M33	1667-1945	2260-2637
M36	2124-2478	2880-3360
M39	2773-3235	3760-4387
M42	3422-3992	4640-5413
M45	4293-5009	5820-6790
M48	5141-5998	6970-8132
M52	6690-7805	9070-10582
M56	8334-9723	11300-13183
M64	12612-14714	17100-19950

Grade 12.9 Bolts, Nuts, and Studs



Usually the torque values specified for grade 10.9 fasteners can be used satisfactorily on grade 12.9 fasteners.

TORQUE SPECIFICATIONS - STEEL HYDRAULIC FITTINGS

Tube OD Hose ID	Thread Size	Pound- Feet	Newton metres
37 Degree Flare Fittings			
1/4 in 6.4 mm	7/16-20	6-12	8-16
5/16 in 7.9 mm	1/2-20	8-16	11-22
3/8 in 9.5 mm	9/16-18	10-25	14-34
1/2 in 12.7 mm	3/4-16	15-42	20-57
5/8 in 15.9 mm	7/8-14	25-58	34-79
3/4 in 19.0 mm	1-1/16-12	40-80	54-108
7/8 in 22.2 mm	1-3/16-12	60-100	81-135
1.0 in 25.4 mm	1-5/16-12	75-117	102-158
1-1/4 in 31.8 mm	1-5/8-12	125-165	169-223
1-1/2 in 38.1 mm	1-7/8-12	210-250	285-338

Tube OD Hose ID	Thread Size	Pound- Feet	Newton metres
Straight Threads with O-ring			
1/4 in 6.4 mm	7/16-20	12-19	16-26
5/16 in 7.9 mm	1/2-20	16-25	22-34
3/8 in 9.5 mm	9/16-18	25-40	34-54
1/2 in 12.7 mm	3/4-16	42-67	57-91
5/8 in 15.9 mm	7/8-14	58-92	79-124
3/4 in 19.0 mm	1-1/16-12	80-128	108-174
7/8 in 22.2 mm	1-3/16-12	100-160	136-216
1.0 in 25.4 mm	1-5/16-12	117-187	159-253
1-1/4 in 31.8 mm	1-5/8-12	165-264	224-357
1-1/2 in 38.1 mm	1-7/8-12	250-400	339-542

Split Flange Mounting Bolts*		
Size	Pound- Feet	Newton metres
5/16-18	15-20	20-27
3/8-16	20-25	27-34
7/16-14	35-45	47-61
1/2-13	55-65	74-88
5/8-11	140-150	190-203

**NOTE: Use standard metric hardware torque for metric split flange mounting bolts.*

TORQUE SPECIFICATIONS - O-RING FACE SEAL FITTINGS

Nom. SAE Dash Size	Tube OD	Thread Size	Pound- Feet	Newton metres	Thread Size	Pound- Feet	Newton metres
O-ring Face Seal End					O-ring Boss End Fitting or Lock Nut		
-4	1/4 in 6.4 mm	9/16-18	10-12	14-16	7/16-20	17-20	23-27
-6	3/8 in 9.5 mm	11/16-16	18-20	24-27	9/16-18	25-30	34-41
-8	1/2 in 12.7 mm	13/16-16	32-40	43-54	3/4-16	45-50	61-68
-10	5/8 in 15.9 mm	1-14	46-56	62-76	7/8-14	60-65	81-88
-12	3/4 in 19.0 mm	1-3/16-12	65-80	90-110	1-1/16-12	85-90	115-122
-14	7/8 in 22.2 mm	1-3/16-12	65-80	90-110	1-3/16-12	95-100	129-136
-16	1.0 in 25.4 mm	1-7/16-12	92-105	125-140	1-5/16-12	115-125	156-169
-20	1-1/4 in 31.8 mm	1-11/16-12	125-140	170-190	1-5/8-12	150-160	203-217
-24	1-1/2 in 38.1 mm	2-12	150-180	200-254	1-7/8-12	190-200	258-271

Section 2001

ENGINE REMOVAL AND INSTALLATION

ENGINE

Removal

1. Park the machine on a hard level surface. Lower the tool to the floor and stop the engine.

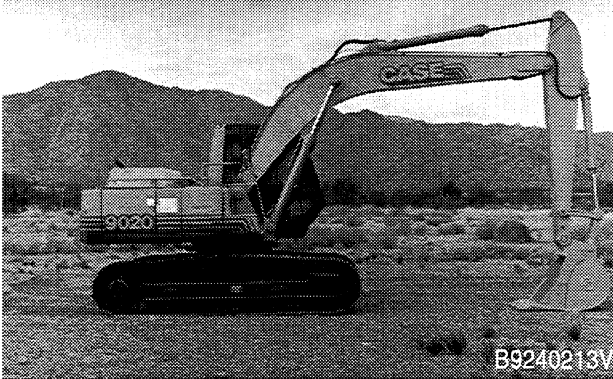

2. Open the access doors over the engine and on each side of the engine compartment. Remove the access covers from under the engine and the radiator.

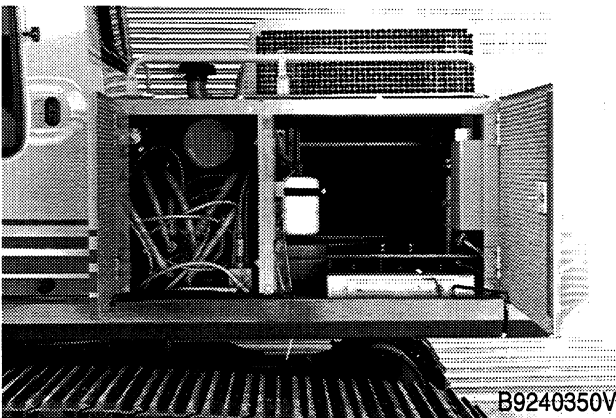

3. Make sure that the engine is cool and remove the radiator cap. Open the drain valve and drain the cooling system. The cooling system holds 18.7 U.S. quarts (17.7 litres) of coolant.



4. Remove the access cover for the batteries and disconnect the ground cable.

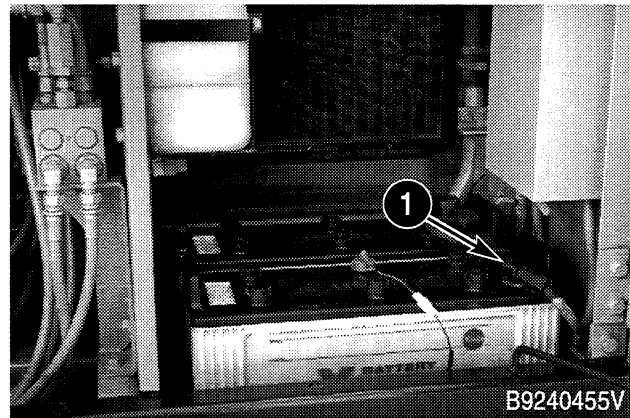

1. Ground Cable

5. Remove the muffler and the mounting bracket for the muffler.
6. Disconnect the hose for the air cleaner from the turbocharger (1).
7. Disconnect the top (3) and bottom (4) radiator hoses from the radiator.
8. Disconnect the hose (2) for the coolant reservoir from the radiator.
9. Remove the fan guard and the fan shroud from the radiator.
10. Remove the cap screws and hardware that hold the fan and the spacer to the engine.
11. Disconnect the fuel supply hose and the fuel return hose. Install a plug in each hose.

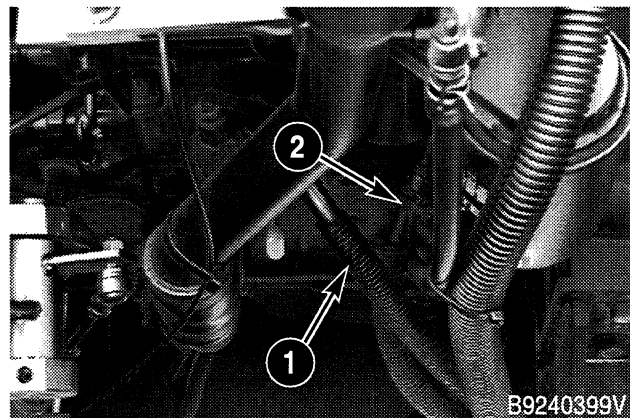

1. Supply Hose

2. Return Hose

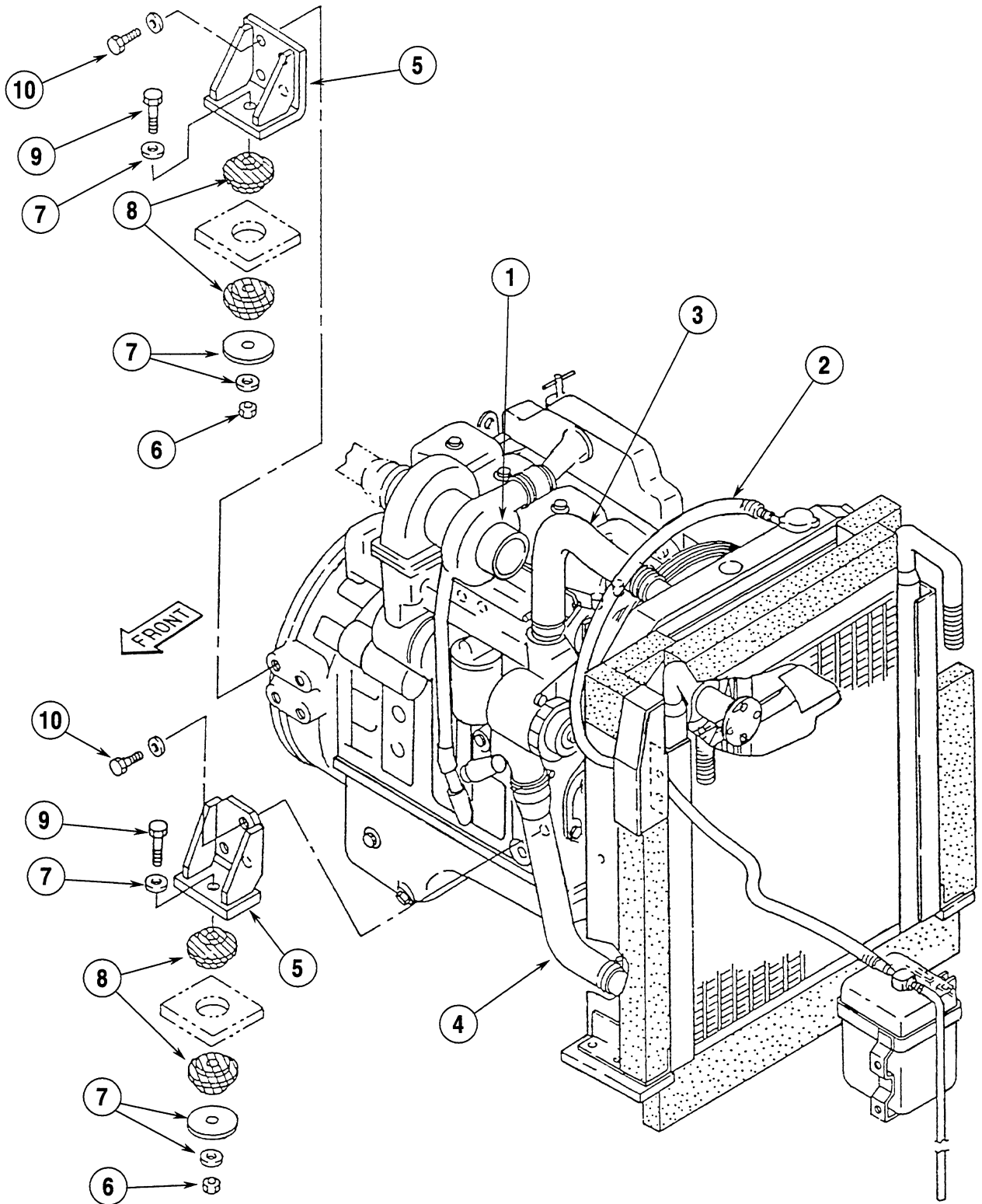

- 1. Disconnect Hose for Air Cleaner Here
- 2. Hose for the Coolant Reservoir
- 3. Top Radiator Hose
- 4. Bottom Radiator Hose
- 5. Engine Mounting Bracket

- 6. Self-Locking Nut
- 7. Washer
- 8. Insulator
- 9. Tighten to 195 to 231 pound-feet (264 to 313 Nm)
- 10. Tighten to 71 to 83 pound-feet (96 to 112 Nm)

B924511J

12. Disconnect the throttle cable from the bellcrank at the bracket on the engine. If the machine is equipped with ether start, disconnect the tube from the fitting in the intake manifold.

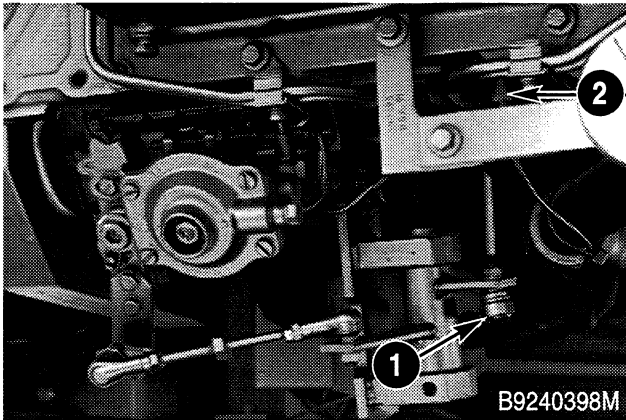

1. Disconnect Throttle Cable Here

2. Tube for Ether Start

13. Put identification tags on the wiring harness, wires and cables connected to the engine for correct assembly. Disconnect the wiring harness, wires and cables from the engine.

14. Disconnect the hoses for the heater from the engine. Install a plug in each hose.
15. Disconnect the ground strap from the engine.
16. Connect acceptable lifting equipment to the lifting eyes on the engine. The weight of the engine is 827 pounds (375 kg).
17. Connect a lifting sling to the hydraulic pump. The weight of the hydraulic pump is 201 pounds (91 kg). Remove the cap screws and hardened washers that hold the hydraulic pump to the flywheel housing.
18. Separate the hydraulic pump from the flywheel housing and disengage the splined shaft of the hydraulic pump from the splined hub in the coupling. The coupling and the drive plate will stay with the flywheel.
19. Remove the self-locking nuts (6), washers (7), insulators (8), and bolts (9) that hold the engine mounting brackets (5) to the frame.
20. Make sure that all hoses, tubes, cables, wires, and wiring harnesses are out of the way.
21. Lift the engine and remove the engine from the machine.

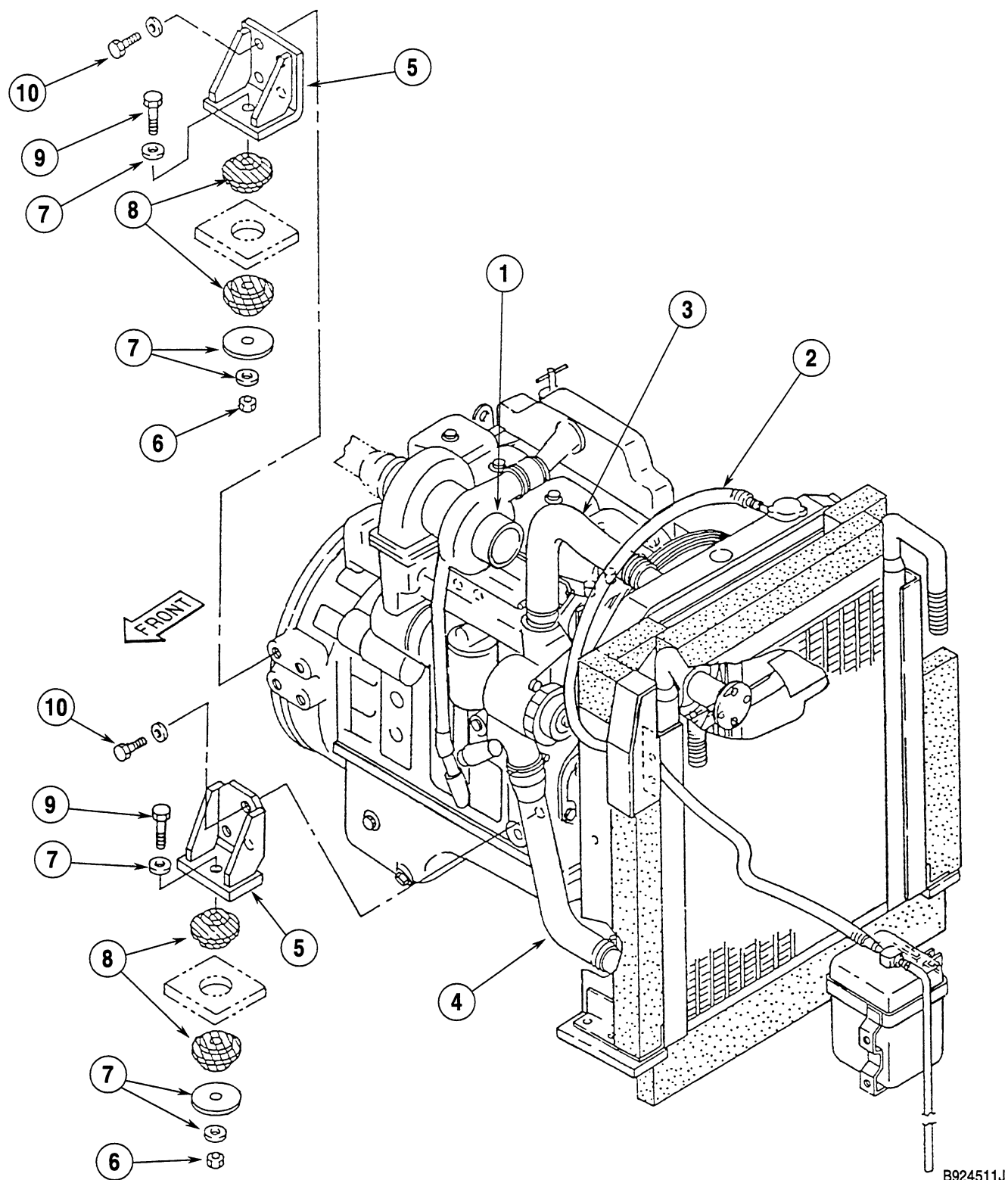

1. Disconnect Hose for Air Cleaner Here
2. Hose for the Coolant Reservoir
3. Top Radiator Hose
4. Bottom Radiator Hose
5. Engine Mounting Bracket

6. Self-Locking Nut
7. Washer
8. Insulator
9. Tighten to 195 to 231 pound-feet (264 to 313 Nm)
10. Tighten to 71 to 83 pound-feet (96 to 112 Nm)

B924511J

Installation

Installation is the reverse sequence of removal.

1. Check the condition of the insulators for the engine mounts. If the insulators are damaged, install new insulators.
2. Align the holes in the drive plate and coupling with the holes in the flywheel. Install the socket head screws that hold the coupling and drive plate to the flywheel. Tighten the socket head screws to the torque specifications shown on page 3.
3. Tighten the bolts that hold the engine mounting brackets to the frame to the torque specifications shown on page 3.
4. Tighten the cap screws that hold the hydraulic pump to the flywheel housing to the torque specifications shown on page 3.
5. Tighten the cap screws that hold the fan and the spacer to the engine to the torque specifications shown on page 3.
6. Do the following procedure to bleed the air from the cooling system.
 - A. Close the drain valve on the radiator. Fill the radiator with coolant and fill the coolant reservoir to the fill neck. If new coolant is being installed, the coolant must be 55% ethylene glycol and 45% water.
 - B. Open the air bleed valve on the aftercooler at the top rear of the engine.

C. Install and tighten the radiator cap.



D. Install and tighten the cap for the coolant reservoir.

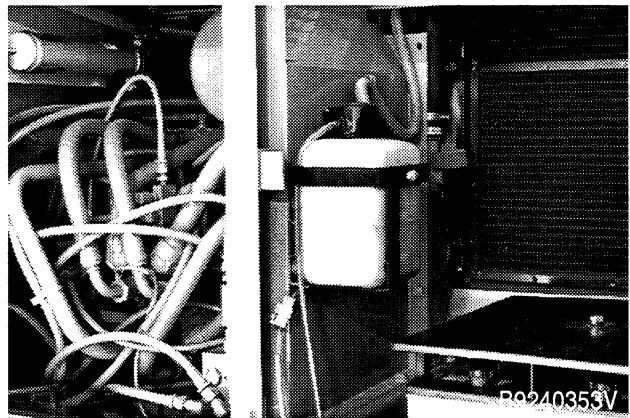

E. Close the shutoff valve for the heater at the top rear of the engine.

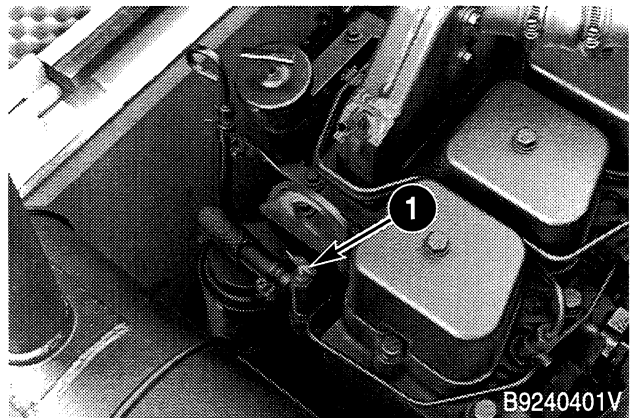

1. Shutoff Valve

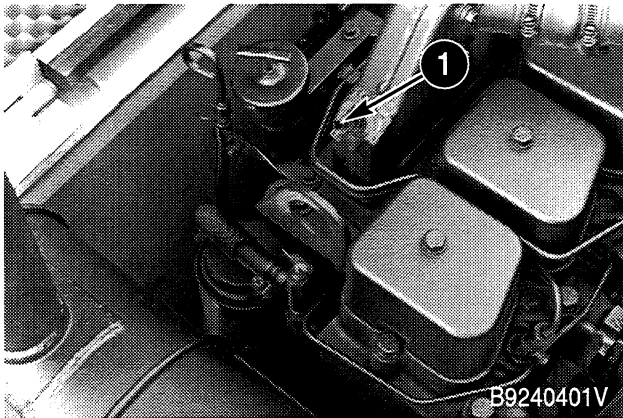

1. Air Bleed Valve

- F. Install a clear plastic hose on the air bleed valve of the aftercooler. Put the other end of the hose into a container.
- G. Have another person help you at this time.
- H. Start and run the engine at low idle. Close the air bleed valve on the aftercooler as soon as the coolant going through the clear plastic hose is free of air bubbles.
- I. Stop the engine. Fill the radiator with coolant again and fill the coolant reservoir again.
- J. Cover the outside of the radiator core (the side away from the fan) with cardboard.
- K. Start and run the engine at high idle. Look at the water temperature gauge. When the water temperature gauge indicates normal operating temperature (4th or 5th bar illuminated), open the shutoff valve for the heater.
- L. Continue to run the engine until the last amber bar illuminates, then remove the cardboard from the radiator.
- M. Reduce the engine speed to low idle. Continue to run the engine at low idle for 30 seconds.
- N. stop the engine and let the coolant cool.
- O. When the radiator feels COLD, remove the radiator cap and the cap for the coolant reservoir.
- P. Fill the radiator with coolant. Install and tighten the radiator cap.
- Q. Fill the coolant reservoir with coolant to the FULL mark. Install the cap for the coolant reservoir.

RADIATOR

Removal

1. Park the machine on a hard level surface. Lower the tool to the floor and stop the engine.

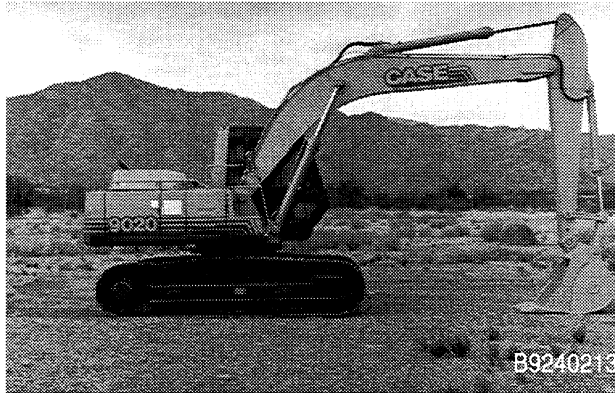

2. Open the access doors over the engine and on the left side of the engine compartment. Remove the access cover from under the radiator.

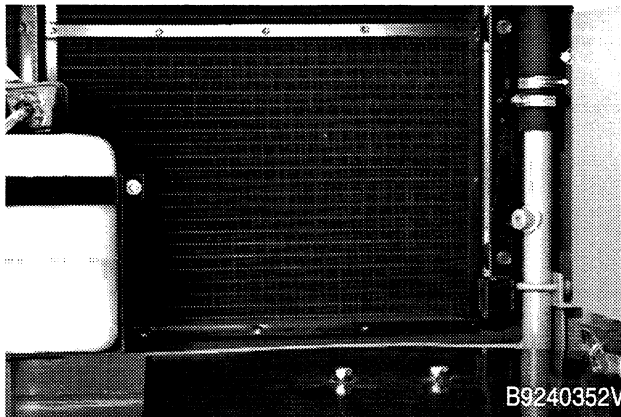

3. Make sure that the engine is cool and remove the radiator cap. Open the drain valve and drain the cooling system. The cooling system holds 18.7 U.S. quarts (17.7 litres) of coolant.

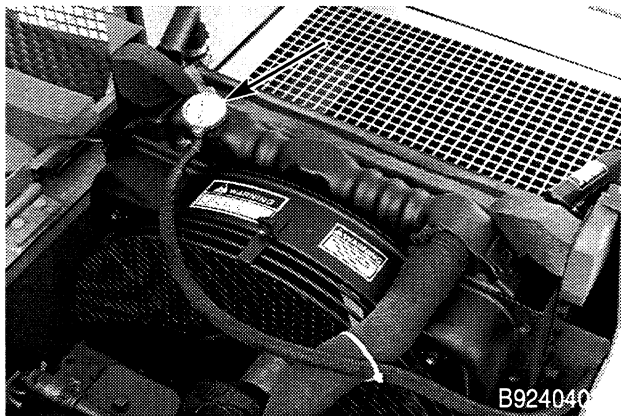

4. Disconnect the top and bottom radiator hoses from the radiator.

5. Disconnect the hose for the coolant reservoir from the radiator.
6. Remove the fan guard and the fan shroud from the radiator.
7. Remove the cap screws and hardware that hold the fan and the spacer to the engine. Remove the fan and the spacer.
8. Connect acceptable lifting equipment to the radiator. The weight of the radiator is 117 pounds (53 kg).
9. Remove the hardware that holds the radiator to the frame.
10. Remove the radiator from the machine.

Installation

Installation is the reverse sequence of removal.

1. If the foam baffles were removed from the radiator, install new foam baffles.
2. Tighten the cap screws that hold the fan and the spacer to the engine to the torque specifications shown on page 2.
3. Do the following procedure to bleed the air from the cooling system.
 - A. Close the drain valve on the radiator. Fill the radiator with coolant and fill the coolant reservoir to the fill neck. If new coolant is being installed, the coolant must be 55% ethylene glycol and 45% water.
 - B. Open the air bleed valve on the aftercooler at the top rear of the engine.

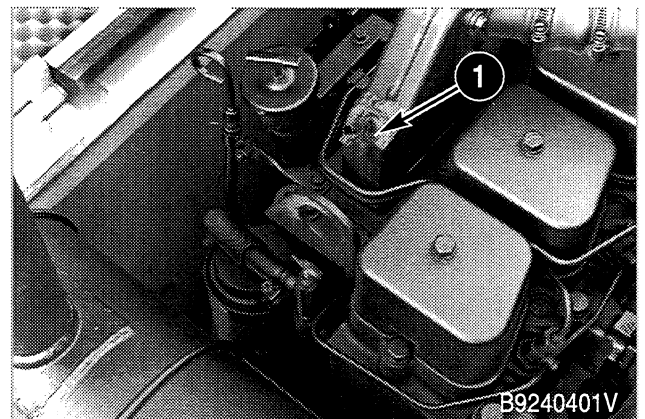

1. Air Bleed Valve

C. Install and tighten the radiator cap.



D. Install and tighten the cap for the coolant reservoir.

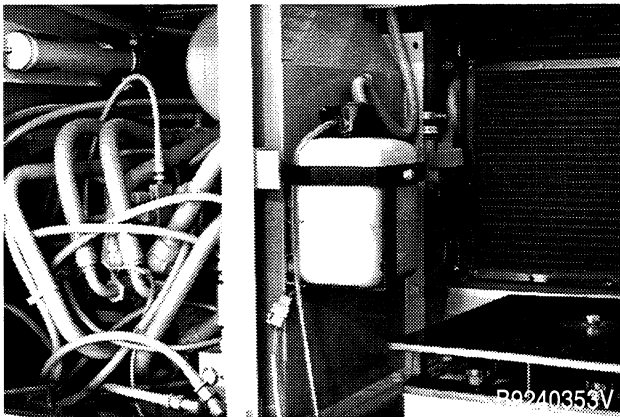

E. Close the shutoff valve for the heater at the top rear of the engine.

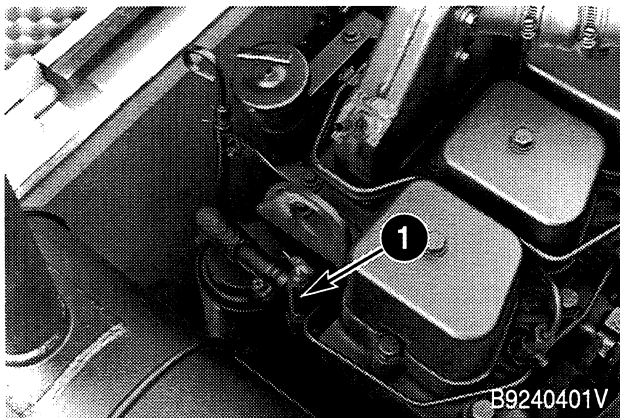

1. Shutoff Valve

F. Install a clear plastic hose on the air bleed valve of the aftercooler. Put the other end of the hose into a container.

G. Have another person help you at this time.

H. Start and run the engine at low idle. Close the air bleed valve on the aftercooler as soon as the coolant going through the clear plastic hose is free of air bubbles.

I. Stop the engine. Fill the radiator with coolant again and fill the coolant reservoir again.

J. Cover the outside of the radiator core (the side away from the fan) with cardboard.

K. Start and run the engine at high idle. Look at the water temperature gauge. When the water temperature gauge indicates normal operating temperature (4th or 5th bar illuminated), open the shutoff valve for the heater.

L. Continue to run the engine until the last amber bar illuminates, then remove the cardboard from the radiator.

M. Reduce the engine speed to low idle. Continue to run the engine at low idle for 30 seconds.

N. Stop the engine and let the coolant cool.

O. When the radiator feels COLD, remove the radiator cap and the cap for the coolant reservoir.

P. Fill the radiator with coolant. Install and tighten the radiator cap.

Q. Fill the coolant reservoir with coolant to the FULL mark. Install the cap for the coolant reservoir.

REMOVING THE AFTERCOOLER

The following photographs show the engine removed from the machine. The aftercooler can be serviced with the engine installed in the machine.

STEP 1

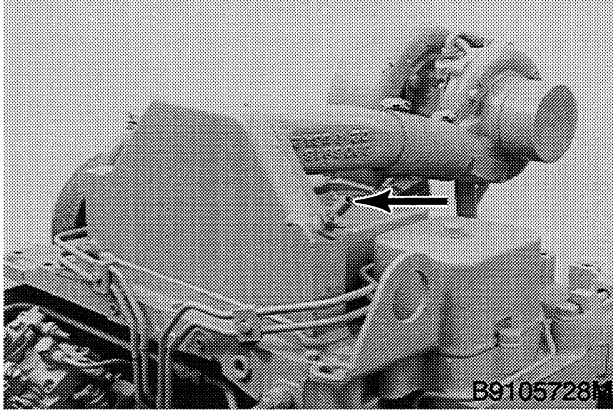

Open the air bleed valve or remove the plug and drain the coolant from the engine. Clean the aftercooler, turbocharger, fuel injector lines, and the area around the aftercooler.

NOTE: During installation, open the air bleed valve or remove the plug on the aftercooler as you fill the radiator with coolant. Close the air bleed valve or install the plug when coolant flows from the air bleed valve.

STEP 2

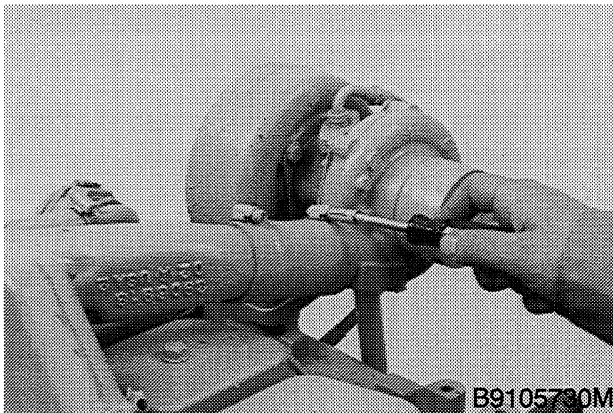

Loosen the clamp on the hose.

STEP 3

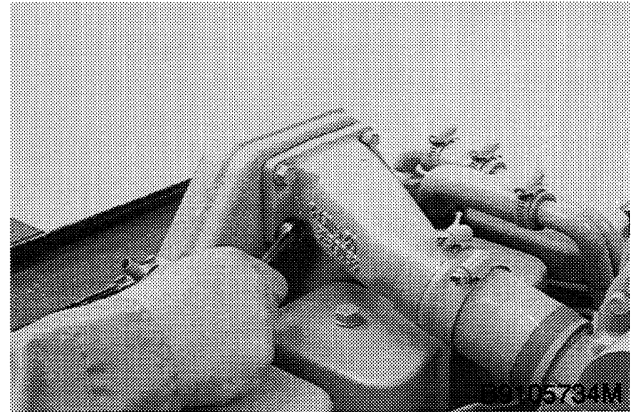

Remove the bolts from the air inlet.

NOTE: During installation, tighten the bolts to 21 to 27 Nm.

STEP 4

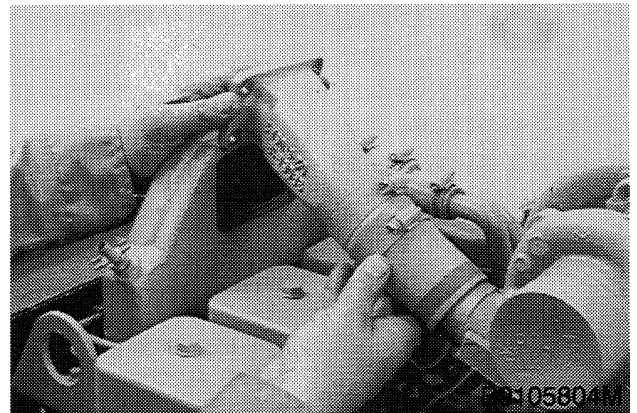

Remove the air inlet and hose.

STEP 5

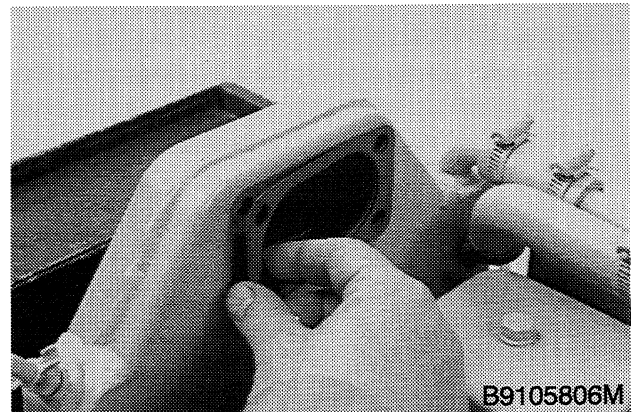

Remove the gasket.

NOTE: During installation, use a new gasket.

STEP 6

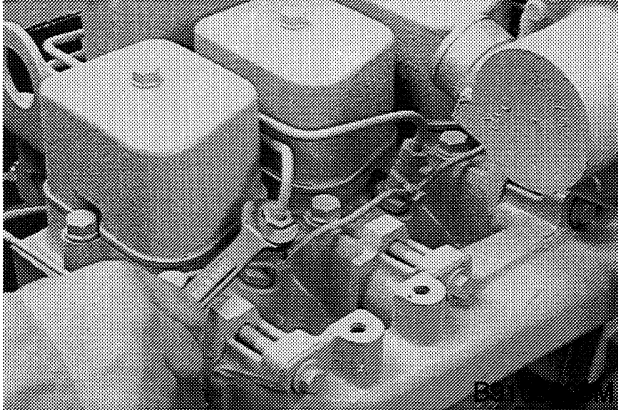

Disconnect the fuel injector lines from the fuel injectors.

NOTE: During installation, tighten the fittings to 22 to 28 Nm.

STEP 7

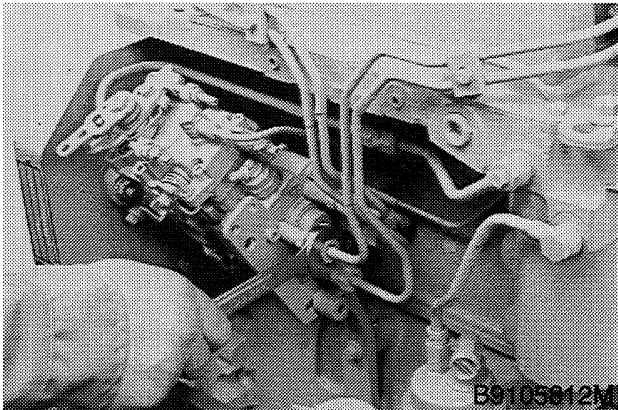

Put identification marks on the fuel injector lines. Disconnect the fuel injector lines from the fuel injection pump.

NOTE: During installation, tighten the fittings to 22 to 28 Nm.

STEP 8

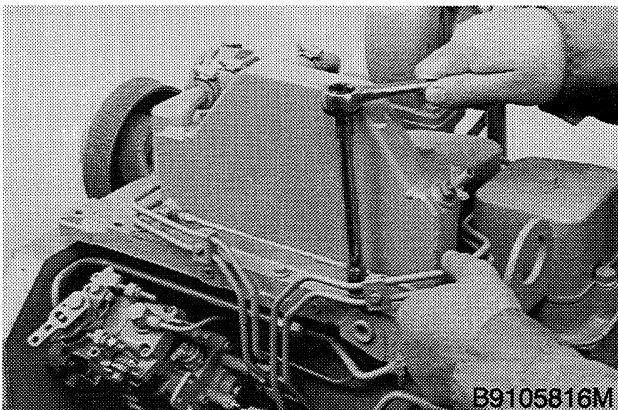

Remove the bolts from the clamps.

STEP 9

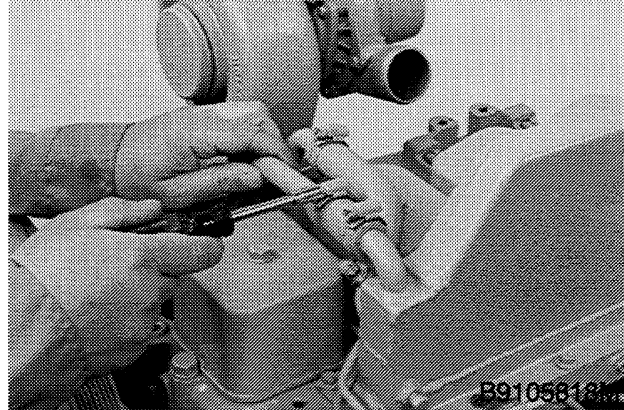

Disconnect the coolant hoses from the aftercooler. Remove the fuel injector lines from the engine.

STEP 10

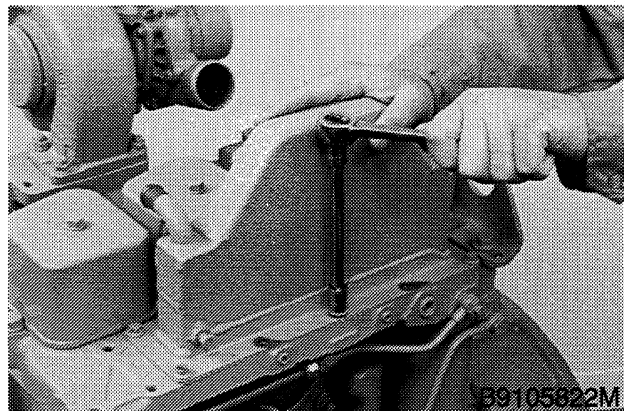

Remove the remainder of the bolts from the aftercooler.

NOTE: During installation, tighten the bolts to 21 to 27 Nm in the sequence shown below.

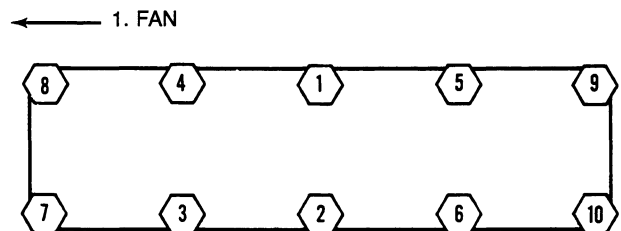

B910620J

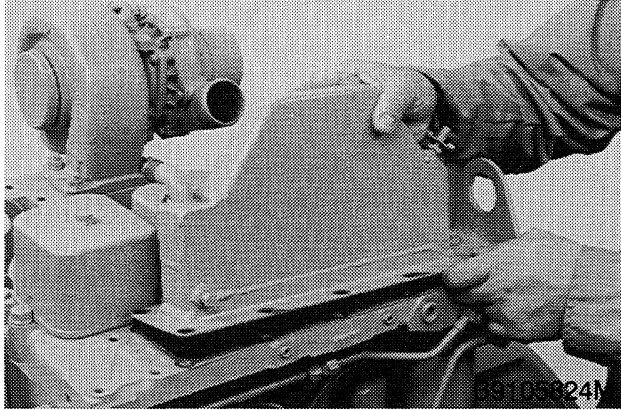
STEP 11

Remove the aftercooler.

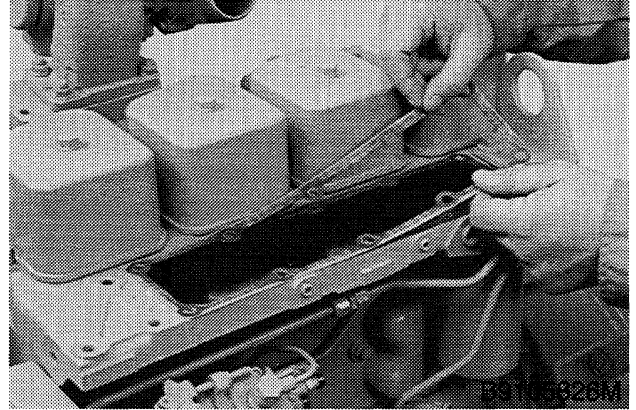
STEP 12

Remove the gasket.

NOTE: During installation, use a new gasket.

INSPECTING THE AFTERCOOLER

Inspect the aftercooler for damage. Inspect the fins inside the aftercooler for damage.

STEP 13

Connect an air hose to the air bleed valve of the aftercooler. Open the air bleed valve. Adjust the air pressure to 125 kPa (1 bar) and hold the aftercooler under water. If there is air leakage, use a new aftercooler.

INSTALLING THE AFTERCOOLER

Install the aftercooler by doing the reverse of Removing the Aftercooler.



Suggest:

If the above button click is invalid.

Please download this document

first, and then click the above link

to download the complete manual.

Thank you so much for reading

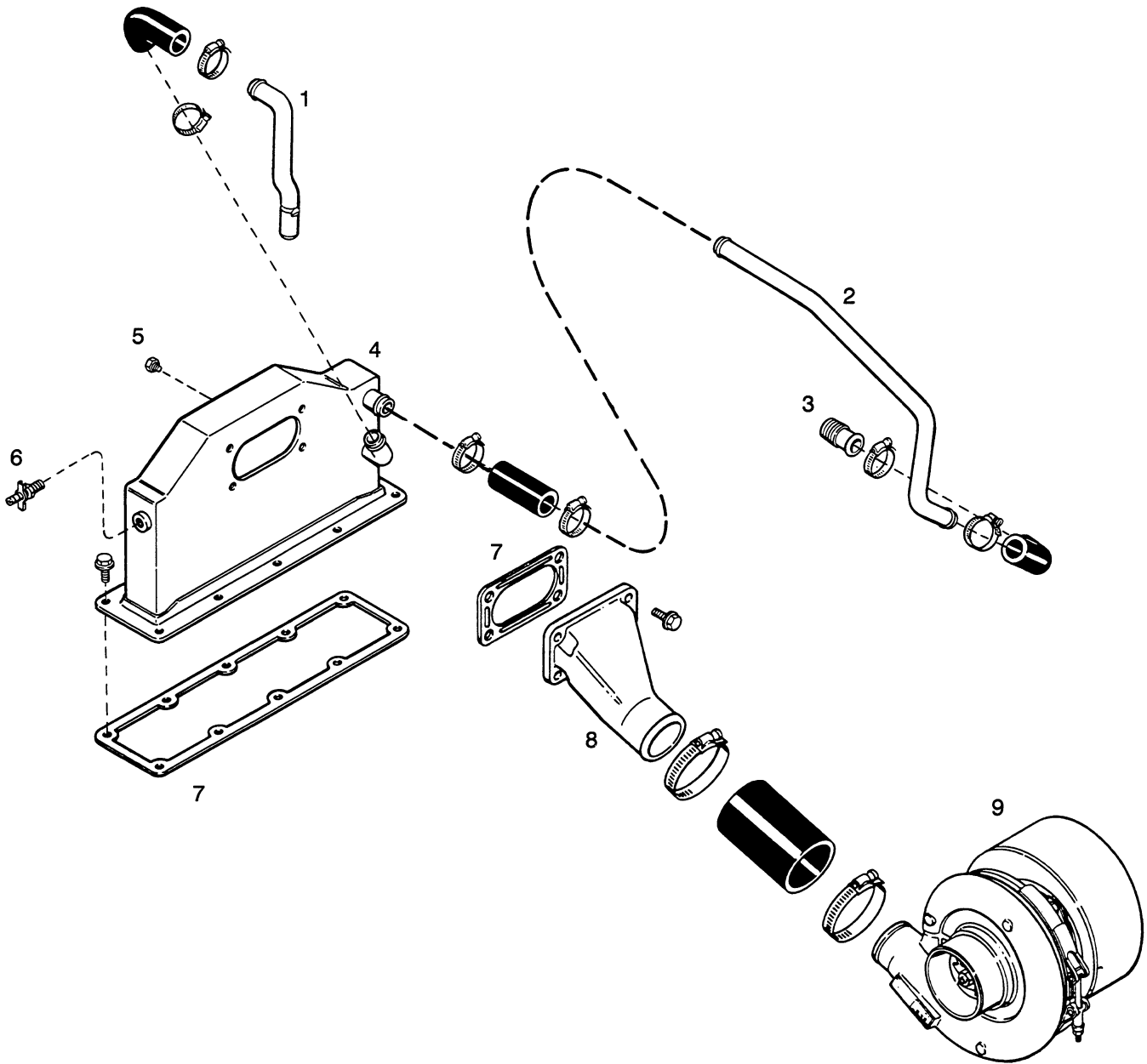

B910614J

- 1. Aftercooler Coolant Outlet
- 2. Aftercooler Coolant Inlet
- 3. To Water Pump

- 4. Aftercooler
- 5. Plug
- 6. Air Bleed Valve

- 7. Gasket
- 8. Air Inlet
- 9. Turbocharger

<https://www.ebooklibonline.com>

Hello dear friend!

Thank you very much for reading.

Enter the link into your browser.

The full manual is available for immediate download.

<https://www.ebooklibonline.com>