

**Service  
Manual  
780 B  
Loader  
Backhoe**

9-69310

**Service  
Manual  
780 B  
Loader  
Backhoe**

9-69310

All Binders  
4.75 in



Large Binder  
2.85 in

Small Binder  
1.63 in

# 780B Loader Backhoe Table of Contents

DIVISION/SECTION	SECTION NO.	FORM NO.
<b>1 GENERAL</b>		
Safety Rules, Service Manual Introduction, and Torque		
Specifications .....	1001	9-69310
Maintenance and Lubrication .....	1002	9-69310
General Engine Specifications .....	1010	8-23230
Detailed Engine Specifications .....	1023	9-78647
<b>2 ENGINES</b>		
Engine Diagnosis - See Section 2201		
Engine Tune-Up .....	2002	8-23140
Engine Stall Tests .....	2003	9-69310
Engine Removal and Installation, Front Engine Support, and Hydraulic Pump Coupling .....	2004	9-69310
Engine Accessories (Air Cleaner, Radiator, and Cold Start System) .....	2005	9-69310
Cylinder Head, Valve Train, and Camshaft .....	2015	8-23250
Cylinder Block, Sleeves, Pistons, and Rods .....	2025	8-23160
Crankshaft, Main Bearings, Flywheel, and Oil Seals .....	2035	8-23170
Lubrication System with Front Mounted Oil Pump .....	2046	8-23270
Lubrication System with Two Gear Balancer and Oil Pump ....	2047	8-23180
Cooling System .....	2055	8-23190
Turbocharger .....	2065	8-23260
Engine Diagnosis .....	2201	8-20110
Reconditioning Engine Cylinder Block .....	2290	8-21170
Turbocharger Failure Analysis .....	2565	8-78235
<b>3 FUEL SYSTEM</b>		
Fuel System and Filters .....	3010	9-75297
Robert Bosch Fuel Injection Pump .....	3012	9-74937
17 mm fuel Injectors .....	3213	8-20240
Fuel Lines, Fuel Tank, and Engine Controls .....	3052	9-69310
Electric Fuel Pump .....	3053	9-69300
<b>4 ELECTRICAL</b>		
Electrical System Troubleshooting .....	4002	9-69300
Wiring Diagrams .....	4003	9-69310
Battery .....	4005	9-69310
Starter .....	4006	9-69300
Alternator .....	4007	9-69300
Instrument Cluster and Instrument Panel .....	4009	9-69300
<b>5 STEERING</b>		
Steering System Troubleshooting .....	5002	9-69310
Steering Control Valve and Steering Column .....	5007	9-69310
Steering Cylinders .....	5010	9-69310
Relief Valve and Check Valve .....	5011	9-69310
Front Axle .....	5021	9-69310

DIVISION/SECTION	SECTION NO.	FORM NO.
6	POWER TRAIN	
	General Transmission Information and Troubleshooting .....	6202 9-69310
	Transmission and Torque Converter .....	6210 9-69310
	Transmission Controls .....	6211 9-69300
	Drive Shaft .....	6222 9-69300
	Differential and Planetaries .....	6226 9-69300
	Wheels and Tires .....	6229 9-69310
7	BRAKES	
	Troubleshooting and General Information for the Air System .	7102 9-69300
	Air Compressor and Governor .....	7103 9-69310
	Air Reservoir and Relief Valve .....	7104 9-69300
	Brake Valves (Treadles) .....	7105 9-69300
	Brake Actuators .....	7107 9-69310
	Alcohol Evaporator .....	7111 9-69300
	Pressure Reducer Valve, Pressure Protection Valve, Double Check Valve, and Clutch Cutout Valve .....	7113 9-69300
	Brakes and Brake Adjusters .....	7123 9-69300
	Parking Brake Control Valve and Quick Release Valve .....	7126 9-69300
8	HYDRAULICS	
	Hydraulic System Diagrams, Maintenance, Troubleshooting, and Pressure Checks .....	8002 9-69310
	Cleaning the Hydraulic System .....	8003 9-69300
	Hydraulic Pump .....	8005 9-69310
	Flow Control Valve .....	8006 9-69310
	Loader Control Valve .....	8007 9-69310
	Loader and Backhoe Cylinders .....	8090 9-69310
	Backhoe Relief Valve .....	8106 9-69310
	Backhoe Control Valve .....	8107 9-69310
	Stabilizer Control Valve .....	8109 9-69310
	Boom Lock .....	8121 9-69310
9	MOUNTED EQUIPMENT	
	Air Conditioning Troubleshooting .....	9002 9-69300
	Air Conditioning System .....	9003 9-69310
	Loader .....	9010 9-69310
	Cab and Canopy .....	9061 9-69310
	Operators Seat and Seat Belts .....	9064 9-69310
	Backhoe .....	9100 9-69310
	Decals and Painting .....	9201 9-69310
	Noise Control .....	9203 9-69300

**<https://www.ebooklibonline.com>**

Hello dear friend!

Thank you very much for reading.

Enter the link into your browser.

The full manual is available for immediate download.

**<https://www.ebooklibonline.com>**

# Section 1001

## SAFETY RULES SERVICE MANUAL INTRODUCTION AND TORQUE SPECIFICATIONS

Written In *Clear  
And  
Simple  
English*

## SERVICE MANUAL INTRODUCTION

This service manual has been prepared with the latest service information available. Troubleshooting, removal, disassembly, inspection and installation procedures, and complete specifications and tightening references can be found in most sections. Some sections have drawings but no written procedure because the job is so easily done. This service manual is one of the most important tools available to the service technician.

### Right, Left, Front, and Rear

The terms right-hand and left-hand and front and rear as used in this manual indicate the right and left sides, and front and rear of the machine as seen from the operator's seat for correct operation of the machine or attachment.

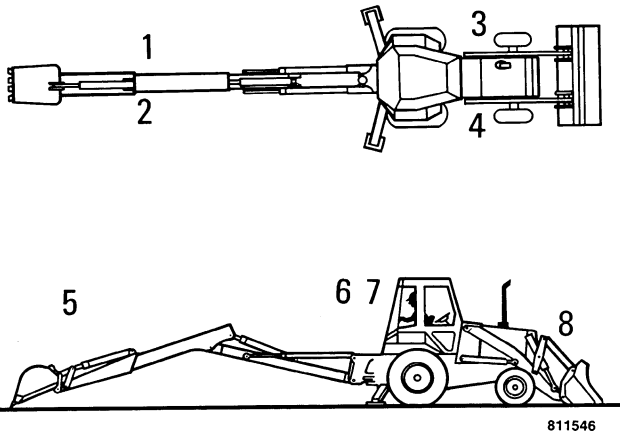

- |                       |                  |
|-----------------------|------------------|
| 1. Right Side-Backhoe | 5. Front-Backhoe |
| 2. Left Side-Backhoe  | 6. Rear-Backhoe  |
| 3. Left Side-Machine  | 7. Rear-Machine  |
| 4. Right Side-Machine | 8. Front-Machine |

Figure 5

### Text

If the service manual is for more than one machine or different models of components (planetary axles, gear boxes, control valves, etc.) the procedures have the steps necessary to service each model.

### Table of Contents

A Table of Contents is in the front of this manual. The Table of Contents shows the main divisions and the sections that are in each division. The individual sections, where necessary, have a Table of Contents on the second page of that section.

### Page Numbers

All page numbers are made of two numbers separated by a dash, such as 4002-9. The number before the dash is the section number. The number following the dash is the page number in that section. Page numbers will be found at the upper right or left of each page.

### Illustrations

Illustrations are put as near as possible to the text and are to be used as part of the text.

### Classification of Lubricants

The SAE number is the viscosity of engine oils; for example, SAE 30, a single viscosity oil. SAE 10W30 is a variable viscosity oil.

The API classification (SD, CD, etc.) is the oil performance in terms of engine usage. Only oil specified in Section 1002 can be used. These oils have the needed chemical additives to give maximum engine protection. Both the SAE grade and API classification must be found on the container.

### Gear Lubricant and Grease

Gear lubricant and grease for each application is specified in Section 1002.

### Special Tools

Special tools are needed to remove and install, disassemble and assemble, check and adjust some component parts of this machine. Some special tools can be easily made locally and the necessary information to make the tool is in this service manual. Other special tools are more difficult to make locally and are available from Service Tools in the U.S. and from Jobborn Manufacturing in Canada. Use these tools according to the instructions in this service manual for your personal safety and to do the job correctly.

Order special tools from either of the following companies:

Service Tools  
P.O. Box 314  
Owatonna, Minnesota 55060

Jobborn Manufacturing Co.  
97 Frid Street  
Hamilton, Ontario L8P 4M3  
Canada

# Product Identification Number (PIN) and Serial Numbers

**NOTE:** A serial number plate is also on many components such as the starter, alternator, pumps, etc.

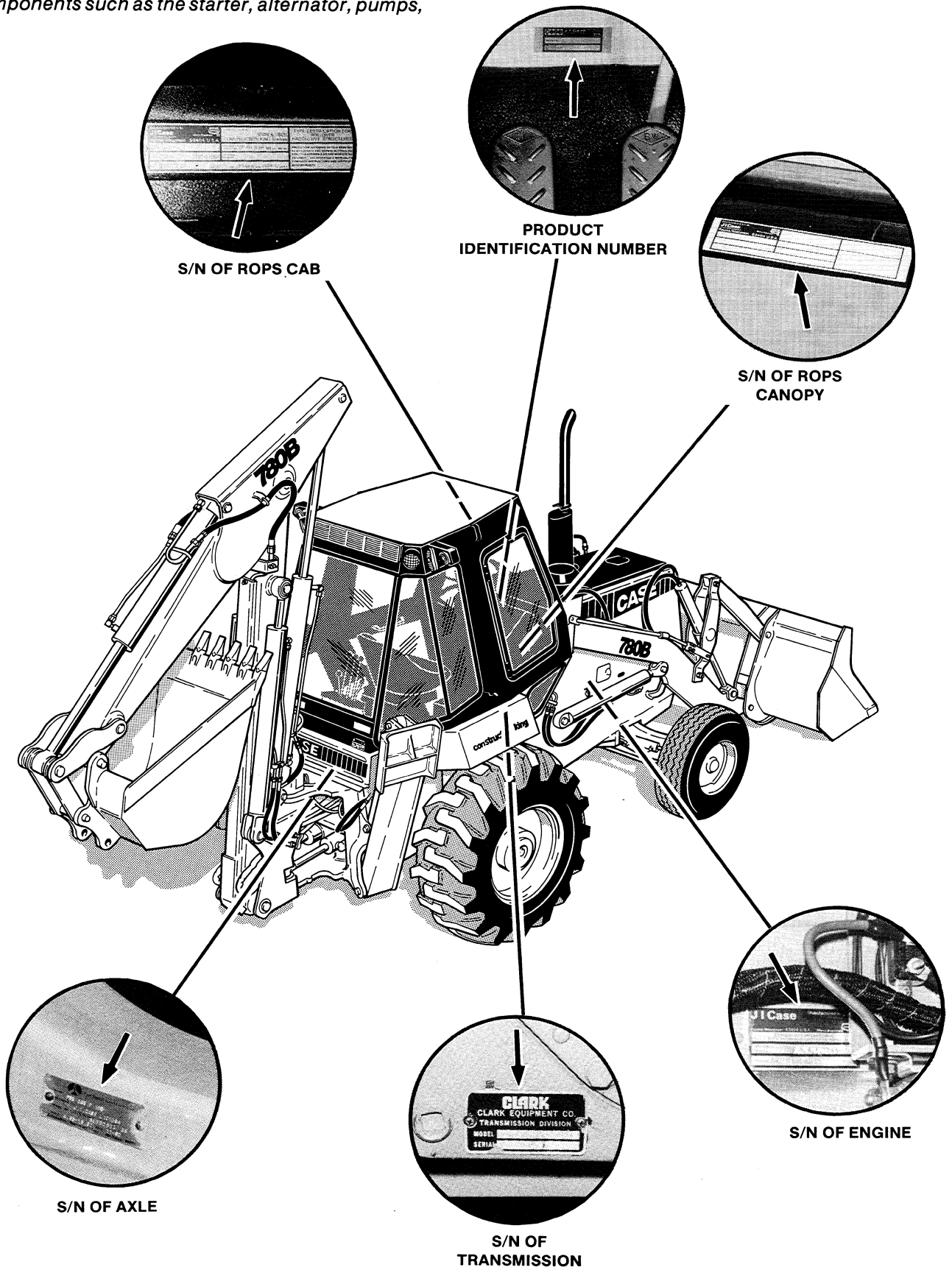



Figure 6

## TORQUE SPECIFICATIONS - U.S. HARDWARE

Use the torques in this chart when special torques are not given. These torques apply to fasteners with both UNC and UNF threads as received from suppliers, dry, or when lubricated with engine oil. Not applicable if special graphites, moly-disulfide greases, or other extreme pressure lubricants are used.

<b>Grade 5 Bolts, Nuts, and Studs</b>			
			
Size	Pound-Feet	Newton metres	Kilogram metres
<b>1/4 in</b> 6.4 mm	9-11	12-15	1.2-1.5
<b>5/16 in</b> 7.9 mm	17-21	23-28	2.4-2.9
<b>3/8 in</b> 9.5 mm	35-42	48-57	4.8-5.8
<b>7/16 in</b> 11.1 mm	54-64	73-87	7.5-8.8
<b>1/2 in</b> 12.7 mm	80-96	109-130	11.1-13.3
<b>9/16 in</b> 14.3 mm	110-132	149-179	15.2-18.2
<b>5/8 in</b> 15.9 mm	150-180	203-244	20.8-24.9
<b>3/4 in</b> 19.0 mm	270-324	366-439	37.3-44.8
<b>7/8 in</b> 22.2 mm	400-480	542-651	55.3-66.4
<b>1.0 in</b> 25.4 mm	580-696	787-944	80.2-96.2
<b>1-1/8 in</b> 28.6 mm	800-880	1085-1193	111-122
<b>1-1/4 in</b> 31.8 mm	1120-1240	1519-1681	155-171
<b>1-3/8 in</b> 34.9 mm	1460-1680	1980-2278	202-232
<b>1-1/2 in</b> 38.1 mm	1940-2200	2631-2983	268-304

<b>Grade 8 Bolts, Nuts, and Studs</b>			
			
Size	Pound-Feet	Newton metres	Kilogram metres
<b>1/4 in</b> 6.4 mm	12-15	16-20	1.7-2.1
<b>5/16 in</b> 7.9 mm	24-29	33-39	3.3-4.0
<b>3/8 in</b> 9.5 mm	45-54	61-73	6.2-7.5
<b>7/16 in</b> 11.1 mm	70-84	95-114	9.7-11.6
<b>1/2 in</b> 12.7 mm	110-132	149-179	15.2-18.2
<b>9/16 in</b> 14.3 mm	160-192	217-260	22.1-26.5
<b>5/8 in</b> 15.9 mm	220-264	298-358	30.4-36.5
<b>3/4 in</b> 19.0 mm	380-456	515-618	52.5-63.0
<b>7/8 in</b> 22.2 mm	600-720	814-976	83.0-99.5
<b>1.0 in</b> 25.4 mm	900-1080	1220-1465	124-149
<b>1-1/8 in</b> 28.6 mm	1280-1440	1736-1953	177-199
<b>1-1/4 in</b> 31.8 mm	1820-2000	2468-2712	252-277
<b>1-3/8 in</b> 34.9 mm	2380-2720	3227-3688	329-376
<b>1-1/2 in</b> 38.1 mm	3160-3560	4285-4827	437-492

**TORQUE SPECIFICATIONS - STEEL HYDRAULIC FITTINGS**

Tube OD Hose ID	Thread Size	Pound- Feet	Newton metres	Kilogram metres
<b>37 Degree Flare Fittings</b>				
<b>1/4 in</b> 6.4 mm	7/16-20	6-12	8-16	0.8-1.7
<b>5/16 in</b> 7.9 mm	1/2-20	8-16	11-21	1.1-2.2
<b>3/8 in</b> 9.5 mm	9/16-18	10-25	14-33	1.4-3.5
<b>1/2 in</b> 12.7 mm	3/4-16	15-42	20-56	2.1-5.8
<b>5/8 in</b> 15.9 mm	7/8-14	25-58	34-78	3.5-8.0
<b>3/4 in</b> 19.0 mm	1-1/16-12	40-80	54-108	5.5-11.1
<b>7/8 in</b> 22.2 mm	1-3/16-12	60-100	81-135	8.3-13.9
<b>1.0 in</b> 25.4 mm	1-5/16-12	75-117	102-158	10.4-16.2
<b>1-1/4 in</b> 31.8 mm	1-5/8-12	125-165	169-223	17.3-22.8
<b>1-1/2 in</b> 38.1 mm	1-7/8-12	210-250	285-338	29.0-34.6

Tube OD Hose ID	Thread Size	Pound- Feet	Newton metres	Kilogram metres
<b>Straight Threads with O-ring</b>				
<b>1/4 in</b> 6.4 mm	7/16-20	12-19	16-25	1.7-2.6
<b>5/16 in</b> 7.9 mm	1/2-20	16-25	22-33	2.2-3.5
<b>3/8 in</b> 9.5 mm	9/16-18	25-40	34-54	3.5-5.5
<b>1/2 in</b> 12.7 mm	3/4-16	42-67	57-90	5.8-9.3
<b>5/8 in</b> 15.9 mm	7/8-14	58-92	79-124	8.0-12.7
<b>3/4 in</b> 19.0 mm	1-1/16-12	80-128	108-174	11.1-17.8
<b>7/8 in</b> 22.2 mm	1-3/16-12	100-160	136-216	13.8-22.1
<b>1.0 in</b> 25.4 mm	1-5/16-12	117-187	159-253	16.2-25.9
<b>1-1/4 in</b> 31.8 mm	1-5/8-12	165-264	224-357	22.8-36.5
<b>1-1/2 in</b> 38.1 mm	1-7/8-12	250-400	339-542	34.6-55.3

<b>Split Flange Mounting Bolts</b>			
Size	Pound- Feet	Newton metres	Kilogram metres
5/16-18	15-20	20-27	2.1-2.8
3/8-16	20-25	26-33	2.8-3.5
7/16-14	35-45	47-61	4.7-6.2
1/2-13	55-65	74-88	7.6-9.0
5/8-11	140-150	190-203	19.4-20.7

# Section 2002

## ENGINE TUNE-UP

Written In *Clear  
And  
Simple  
English*

## ENGINE TUNE-UP

A COMPLETE ENGINE TUNE-UP MUST INCLUDE ALL OF THE FOLLOWING ITEMS:

Checking Top Center .....	4-10
Adjusting The Rocker Arm To Valve Clearance .....	11,12
Checking The Nozzle Spray Pattern And The Engine Compression .....	13-15
Cleaning The Fuel Filters .....	15
Cleaning The Air Intake Filters .....	16
Timing The Injection Pump .....	16-18
Adjusting The Governed Speed .....	18
Adjusting The Fan Belts And The Compressor Belt .....	19
Checking The Valve Timing .....	19,20

## SPECIAL TORQUES

	U.S. Value	Metric Value
Fuel Injector Retaining Nut .....	35 to 45 ft. lbs.	48 to 61 Nm (4.8 to 6.1 kgm)
Fuel Injector Inlet Fittings .....	18 to 22 ft. lbs.	24 to 30 Nm (2.4 to 3.0 kgm)
Fuel Injector Leak Off Line Nuts .....	35 to 45 in. lbs.	4 to 5 Nm (0.4 to 0.5 kgm)
Rocker Arm Studs And Nuts .....	40 to 45 ft. lbs.	54 to 61 Nm (5.4 to 6.1 kgm)
Cylinder Head Cover Nuts .....	8 to 10 ft. lbs.	11 to 14 Nm (1.1 to 1.4 kgm)
Rocker Arm Valve Adjusting Nut .....	20 to 25 ft. lbs.	27 to 34 Nm (2.7 to 3.4 kgm)

### SPECIAL TOOLS

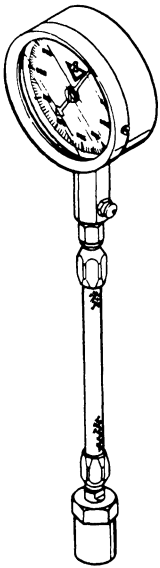

COMPRESSION GAUGE

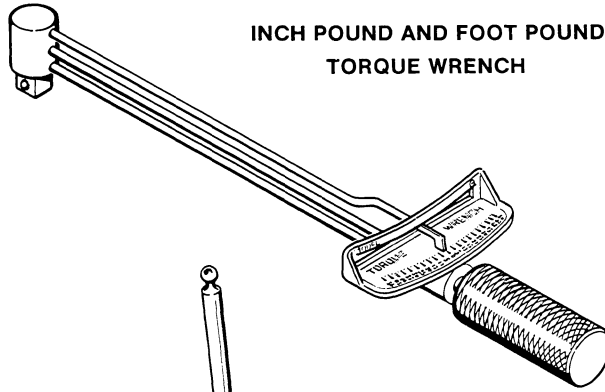

INCH POUND AND FOOT POUND TORQUE WRENCH



INJECTOR BORE CLEANER CAS-1411

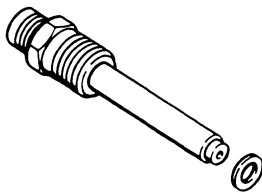

COMPRESSION GAUGE ADAPTER CAS-1410

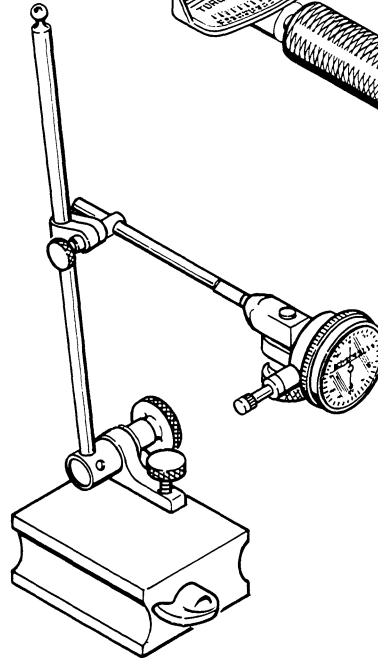

DIAL INDICATOR

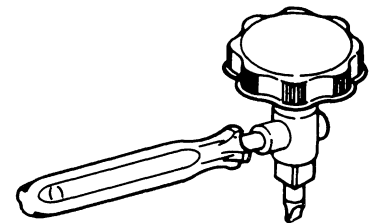

TAPPET ADJUSTMENT TOOL

### SPECIFICATIONS FOR TOOLS WHICH MUST BE MADE

#### Valve Spring Compressor Tool

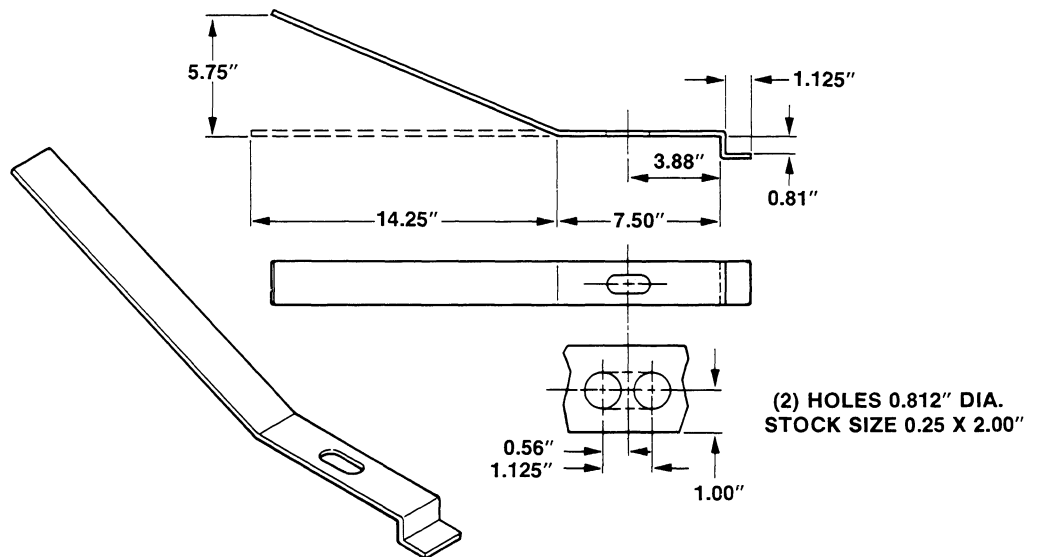

## ENGINE TUNE-UP PROCEDURE

### Checking Top Center

#### STEP 1

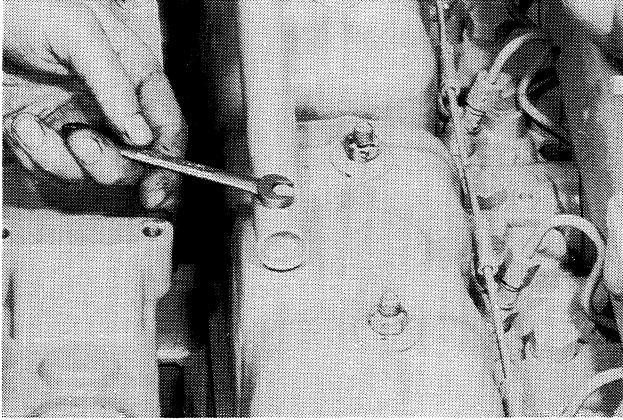

Remove the breather tube and gasket.

#### STEP 2

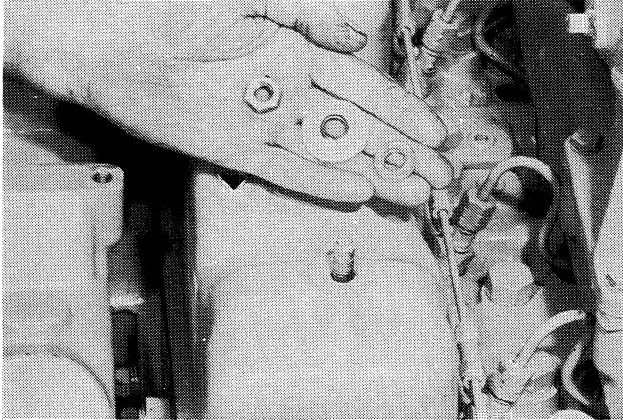

Remove the nuts, washers and rubber gaskets from the front valve cover.

#### STEP 3

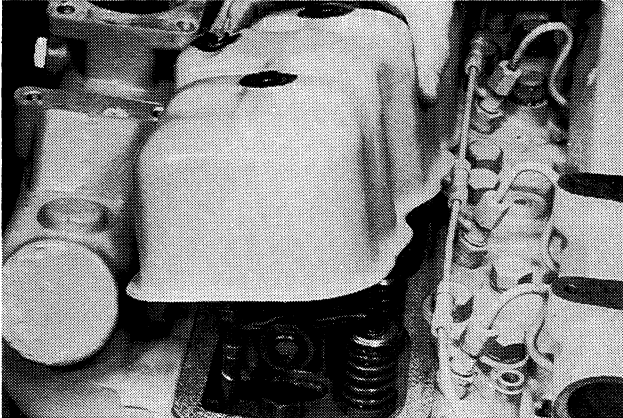

Remove the front valve cover.

#### STEP 4

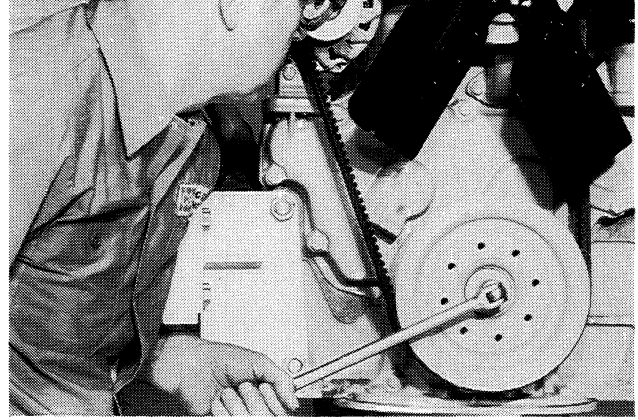

Turn the engine over until the Top Center mark on the crankshaft pulley is aligned with the timing pointer.

#### STEP 5

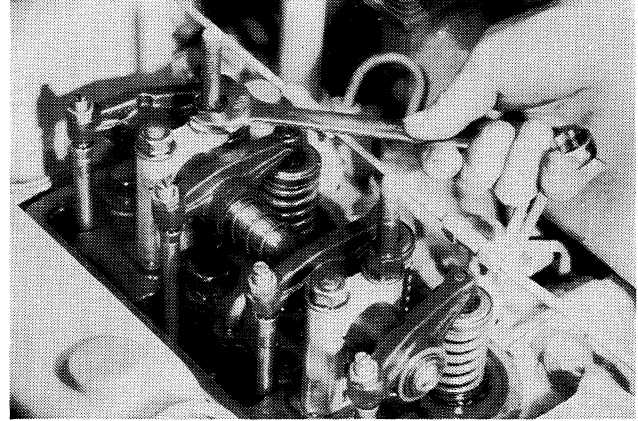

Remove the rocker arm retaining studs, nuts and washers.

#### STEP 6

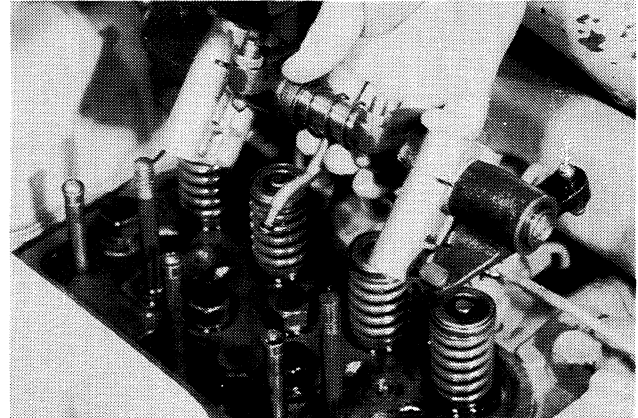

Remove the rocker arm assembly.

**STEP 7**

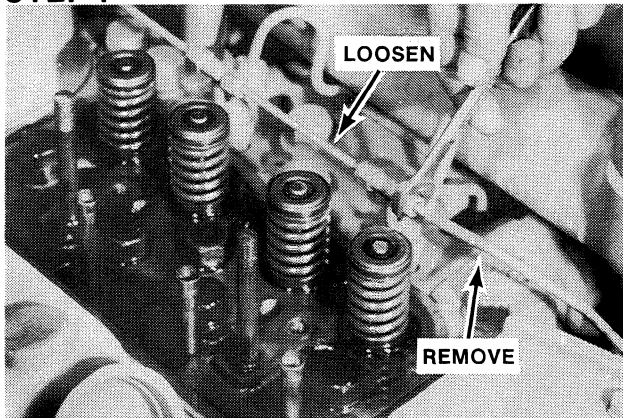

Remove the leak off line from the Number One fuel injection nozzle to the fuel pump. Loosen the leak off line between the Number One and the Number Two fuel injection nozzles.

**NOTE:** Removal of fuel lines will prevent damage to the lines when removing the exhaust valve spring.

**STEP 8**

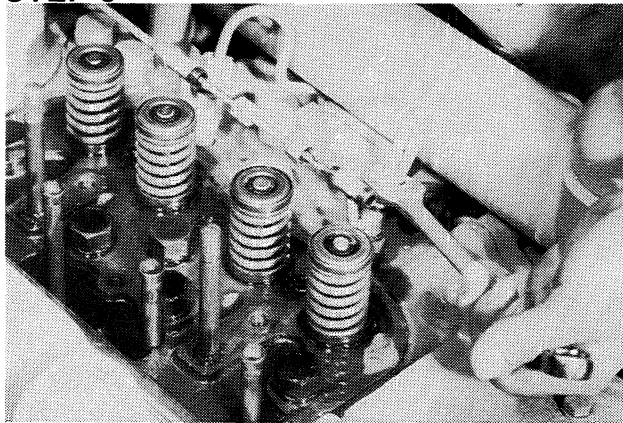

Loosen the Number One nozzle fuel line.

**STEP 9**

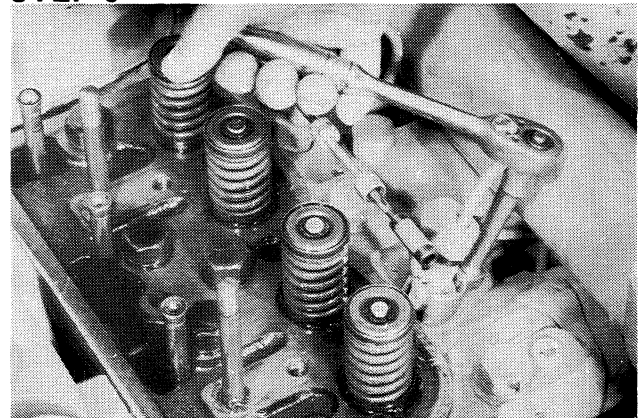

Loosen the retaining nut of the Number One nozzle using a 7/8" crow's foot wrench (Snap-On Tool Part Number AN-8508-14, flared nut type or AN-8506-8, open end type) with an extension and ratchet wrench.

**STEP 10**

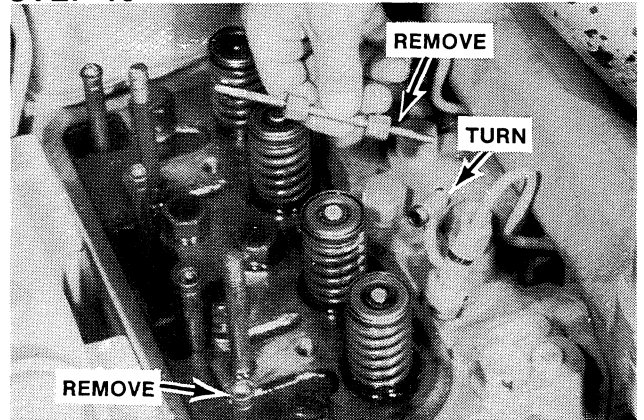

Remove the leak off line and turn the fuel injector nozzle toward the rear of the engine. Remove the Number One cylinder exhaust push rod.

**STEP 11**

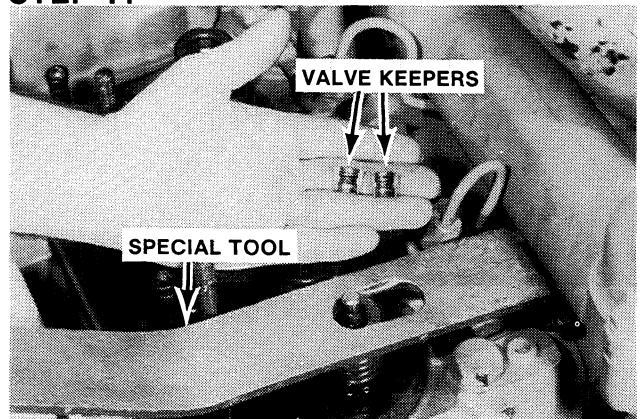

Push down the exhaust valve spring on the Number One cylinder, using a special tool and remove the valve keepers. See Special Tools Page for making this tool.

**STEP 12**



Remove the exhaust valve rotator.

**STEP 13**

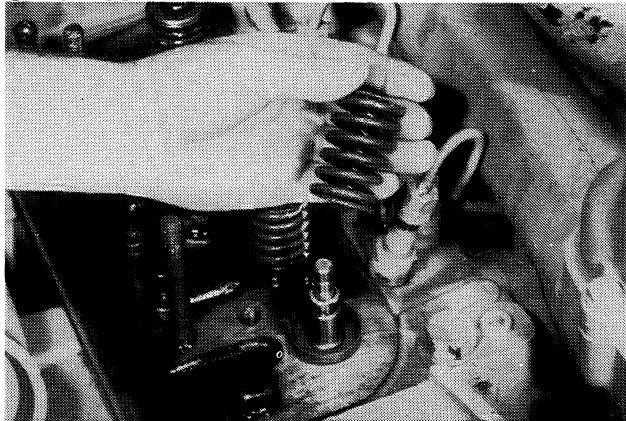

Remove the exhaust valve spring.

**STEP 14**

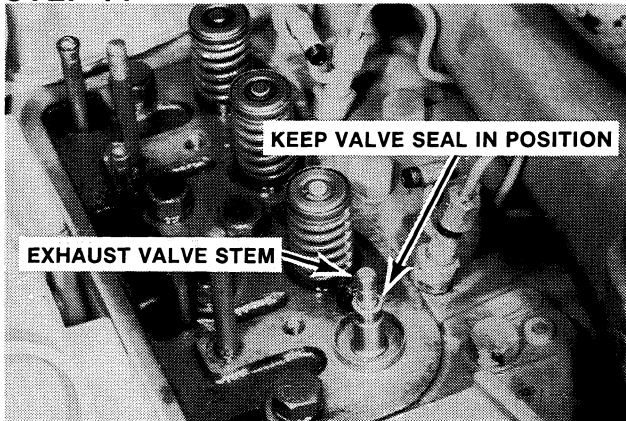

Keep the valve seal in position to prevent the valve from falling through the valve guide if the piston is moved too far.

**STEP 15**

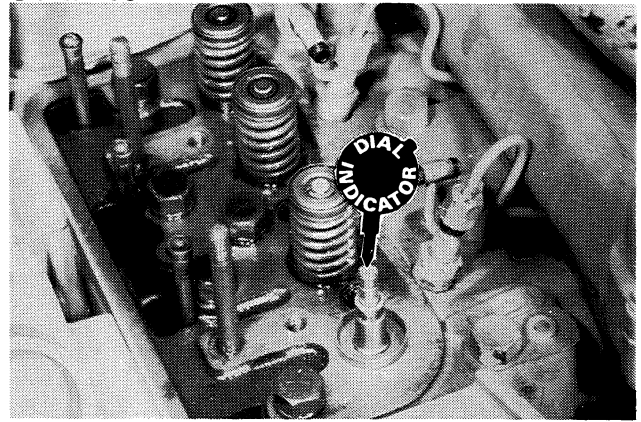

Install a dial indicator on the end of the valve stem with the valve face in contact with the top of the piston.

**STEP 16**

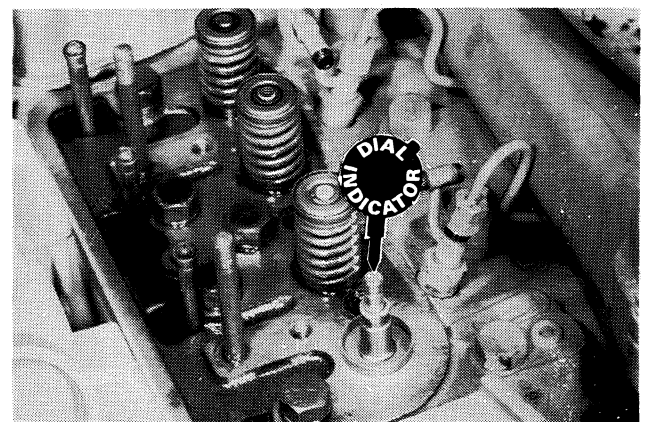
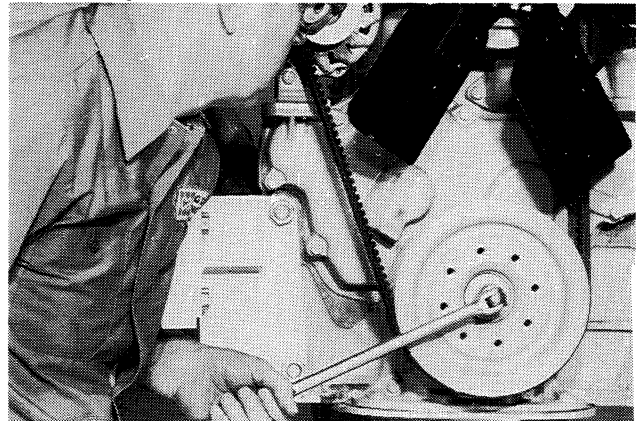

Turn the engine over clockwise until the dial indicator hand stops moving. Reset the indicator to zero.

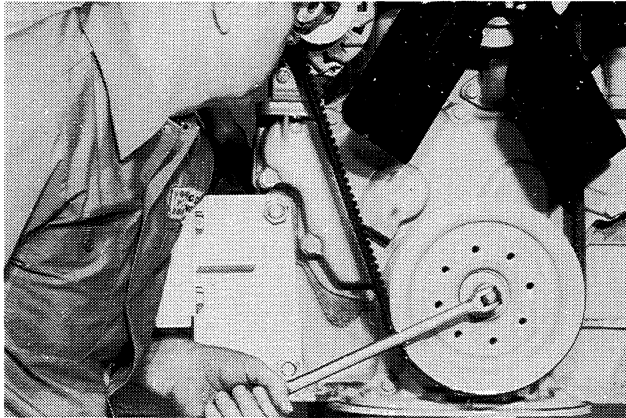
**STEP 17**

Turn the engine over clockwise, approximately 5 degrees until 0.010" (0.254 mm) shows on the dial. Put a mark on the crankshaft pulley in line with the timing pointer.

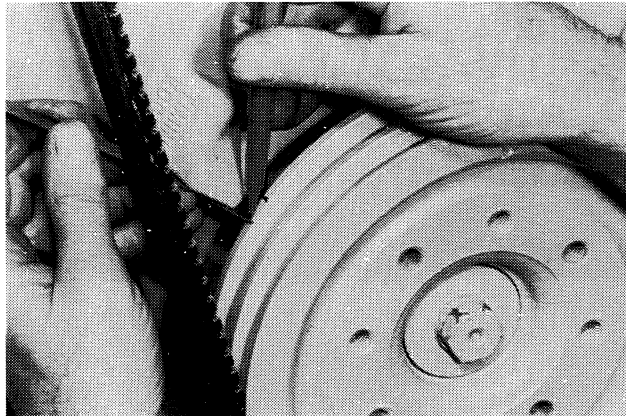

Turn the engine over counterclockwise past the zero mark on the indicator until 0.010" (0.254 mm) shows on the dial. Again, put a mark on the crankshaft pulley.

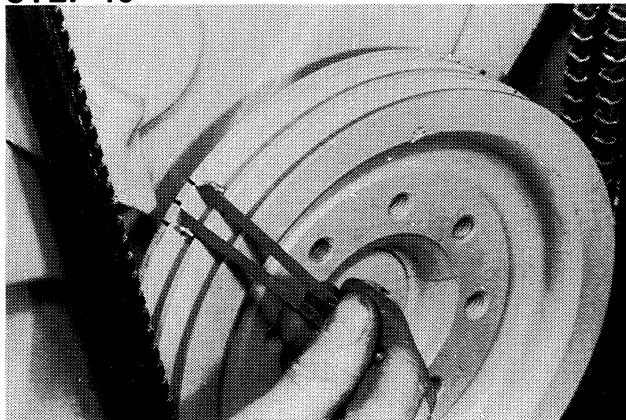
**STEP 18**

Half the distance between the two marks on the crankshaft pulley will be Top Center.

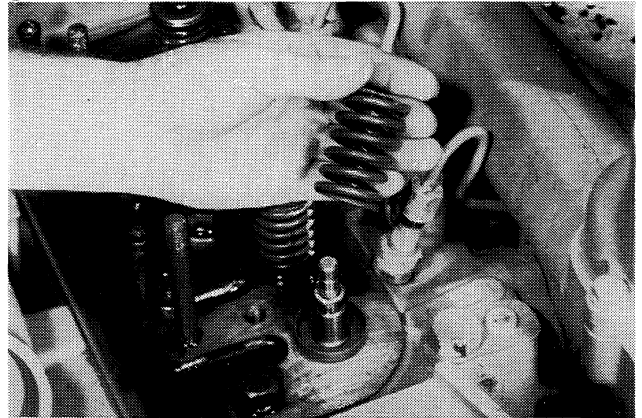
**STEP 19**

Turn the engine over to Top Center and install the valve spring in the spring seat.

**NOTE:** *Install either end of the spring against the spring seat because both ends of the spring are closed.*

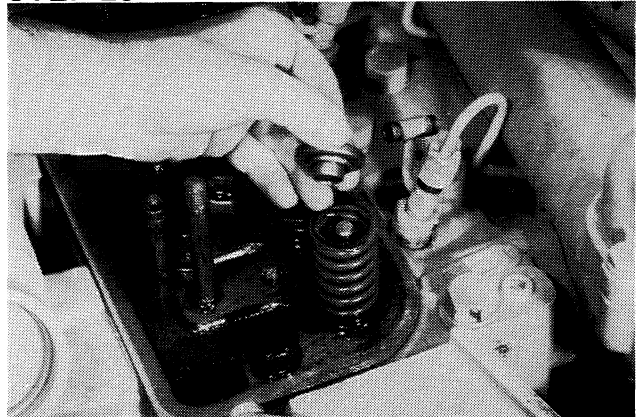
**STEP 20**

Install the valve rotator (flat side up).

**STEP 21**

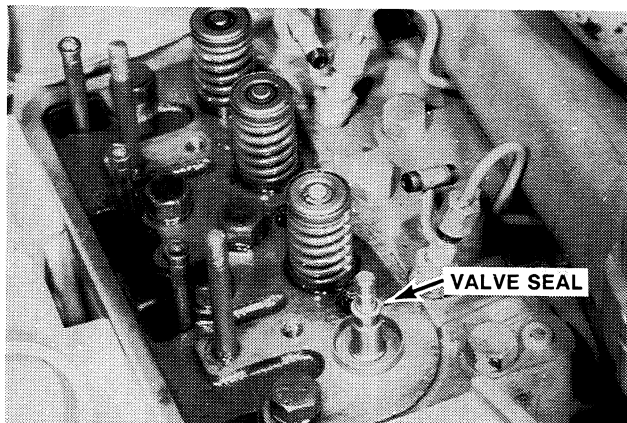
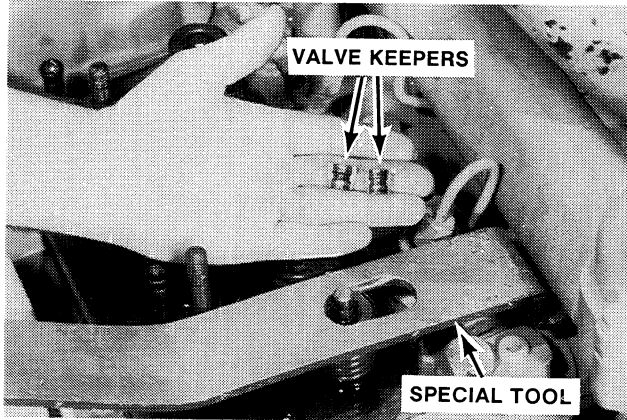

Push down the valve spring using a special tool. Install a new valve seal in the lower valve stem groove. Install the valve keepers (narrow end down) in the upper valve stem groove.

**STEP 22**

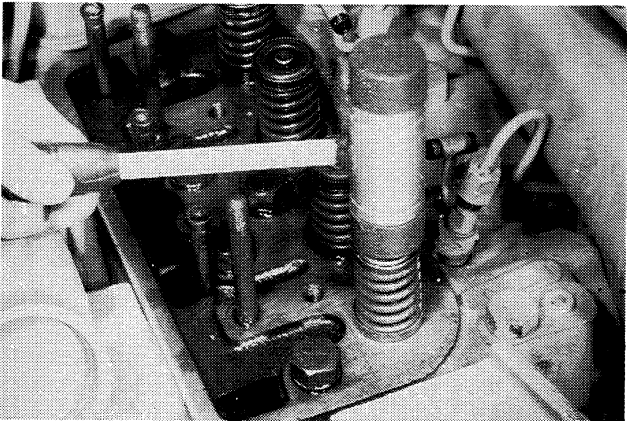

Remove the spring compressor tool. Lightly hit the end of the valve stem to seat the keepers.

**STEP 23**

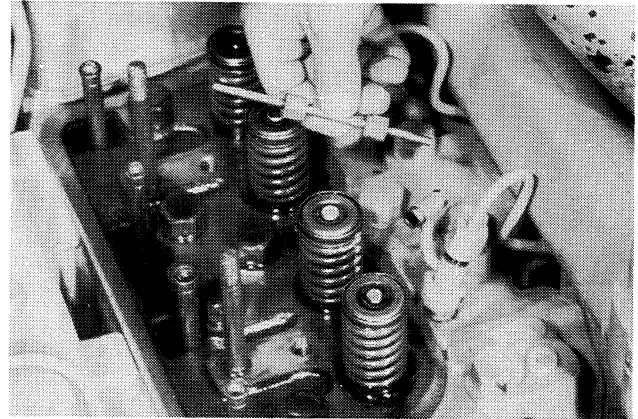

Install the Number One Cylinder exhaust push rod. Install the leak off line, loosely, between the Number One and the Number Two fuel injection nozzles, to put the injector in alignment with the other injectors.

**STEP 24**

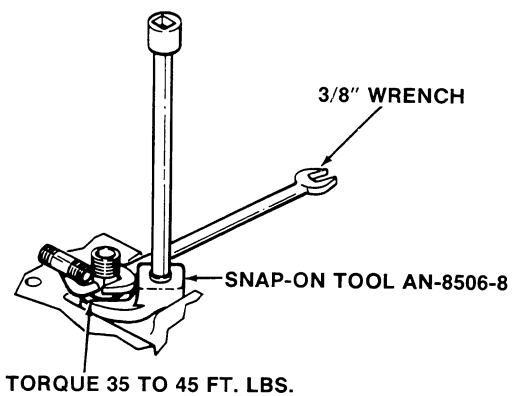
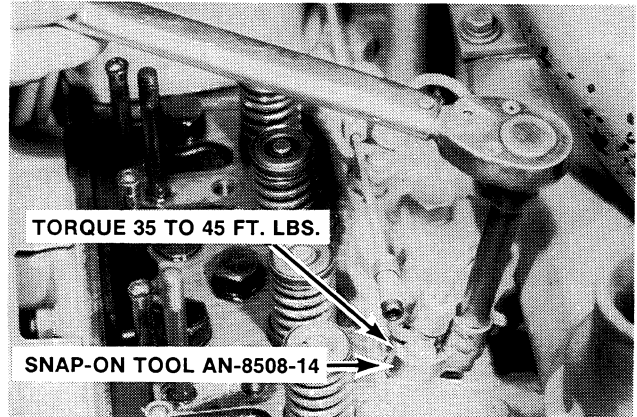

Use a 3/8" open end wrench on the flats of the injector body to hold the injector in alignment with the other injectors. Tighten the injector retaining nut to a torque of 35 to 45 ft. lbs. (48 to 61 Nm) (4.8 to 6.1 kgm), using a 7/8" crowsfoot wrench (Snap-On Tool Part Number AN-8508-14, Flared Nut Type) or (Snap-On Tool Part Number AN-8506-8, Open End Type).

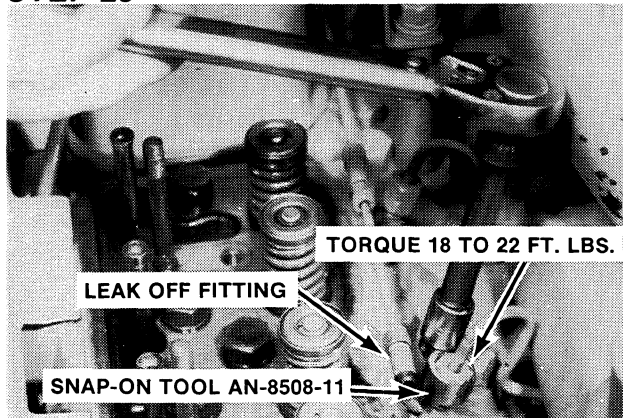
**STEP 25**

Connect the inlet fitting to the fuel injector. Tighten to a torque of 18 to 22 ft. lbs. (24 to 30 Nm) (2.4 to 3.0 kgm), using a 11/16" crowsfoot wrench (Snap-On Tool Part Number AN-8508-11).

**IMPORTANT:** Be careful not to hit the injector leak off fitting with the wrench. Leakage in the fittings can result.

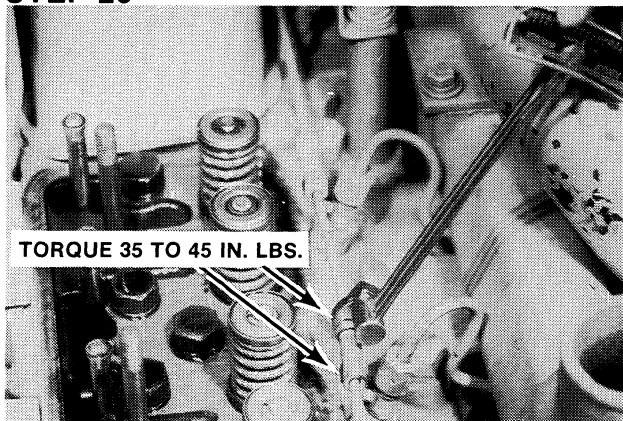
**STEP 26**

Install the leak off line from the Number One fuel injection nozzle to the fuel pump. Tighten the leak off line nuts to a torque of 35 to 45 in. lbs. (4 to 5 Nm) (0.4 to 0.5 kgm).

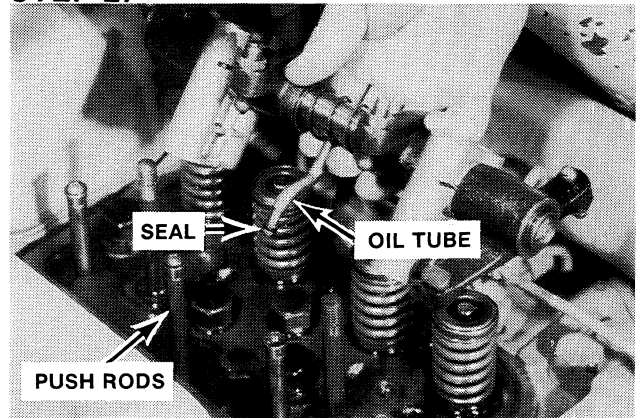
**STEP 27**

Install the rocker arm assembly. Check the seal to make sure seal is not damaged.

**IMPORTANT:** Make sure that the seal is on the oil tube and that the oil tube end is toward the push rods.

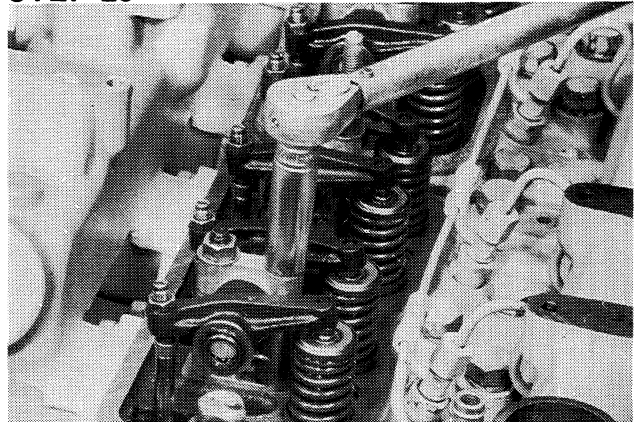
**STEP 28**

Install the rocker arm retaining studs, nuts and washers. Tighten the studs and nuts to a torque of 40 to 45 ft. lbs. (54 to 61 Nm) (5.4 to 6.1 kgm).

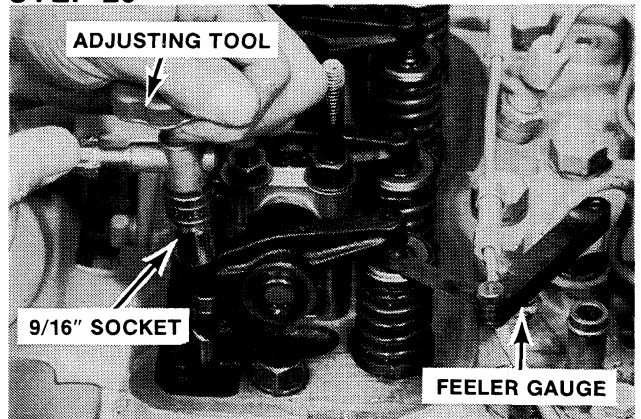
**STEP 29**

Turn the engine over two revolutions to seat the push rod. Then, adjust the valve clearance on No. 1 and No. 2 cylinders, see Steps 37 through 40.

**STEP 30**

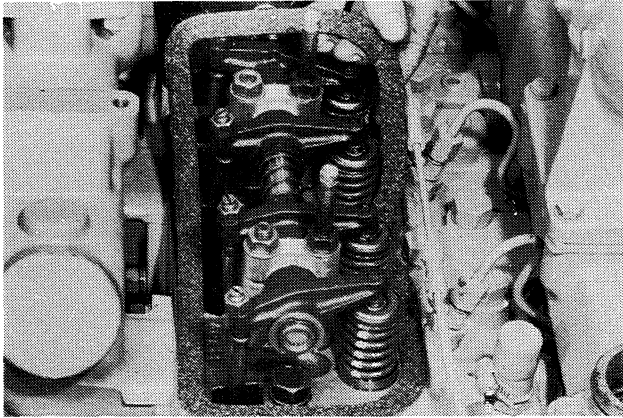

Install a new valve cover gasket.

**STEP 33**

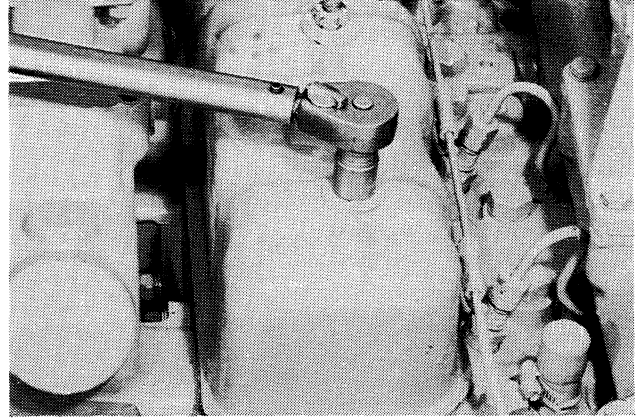

Tighten the nuts to a torque of 8 to 10 ft. lbs. (11 to 14 Nm)(1.1 to 1.4 kgm).

**STEP 31**

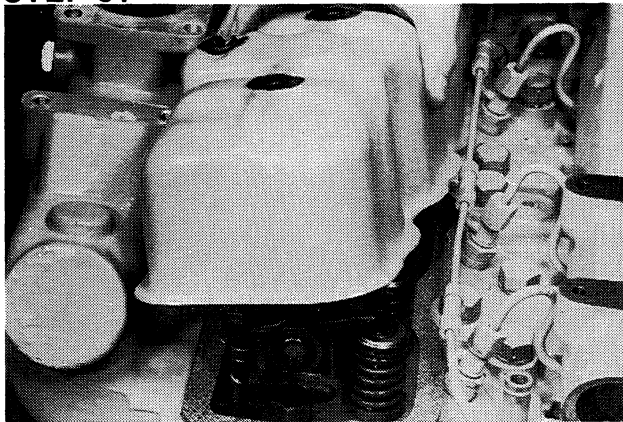

Install the valve cover.

**STEP 34**

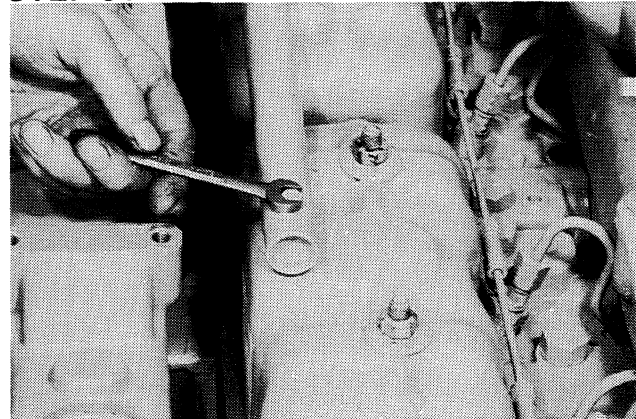

Install the breather tube and gaskets.

**STEP 32**

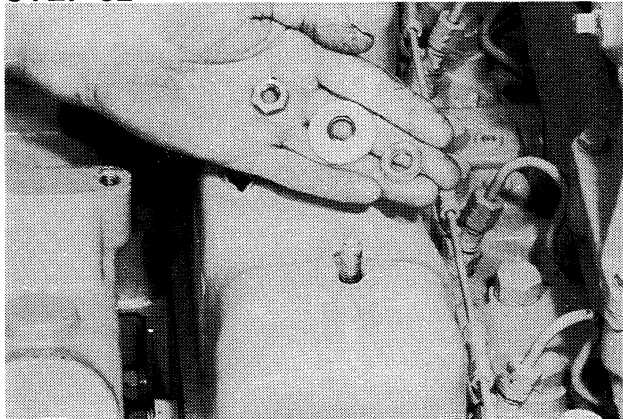

Install the valve cover seals, washers and nuts.

## Adjusting The Rocker Arm To Valve Clearance

**IMPORTANT:** Valve clearance adjustments must be made when the engine is not running.

### STEP 35

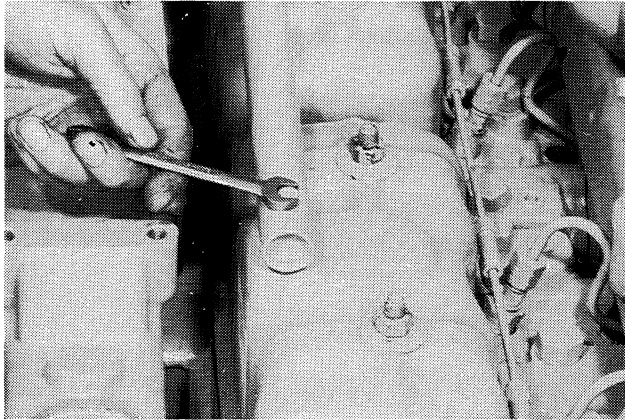

Remove the breather tube.

### STEP 36

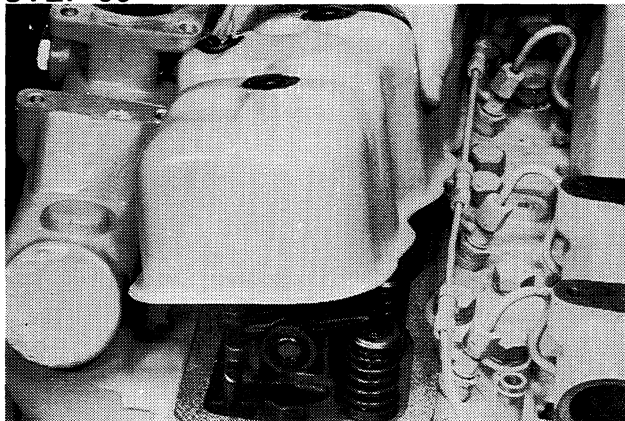

Remove the valve covers.

### STEP 37

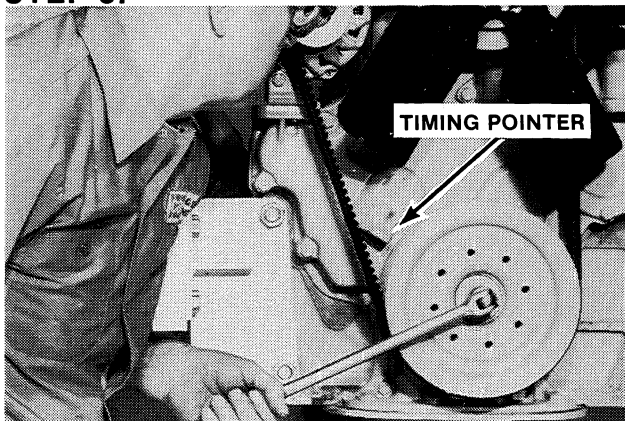

Turn the engine over until the timing pointer is aligned with the Top Center timing mark on the crankshaft pulley.

### STEP 38

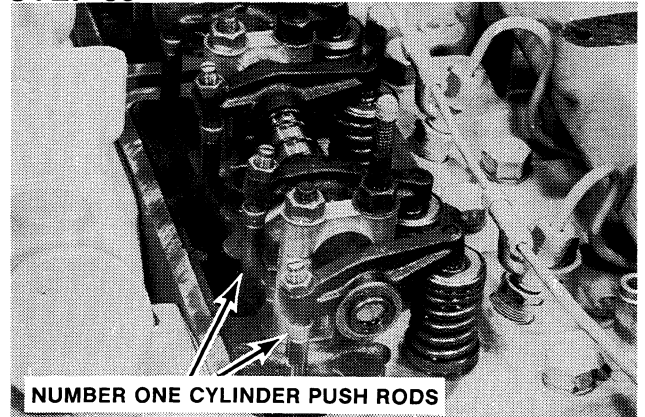

Check the push rods on the Number One cylinder for looseness. If the push rods are loose, the Number One cylinder will be at Top Center on the compression stroke. If the push rods are tight, turn the engine over one complete revolution and align the timing pointer with the Top Center mark on the crankshaft pulley.

### STEP 39

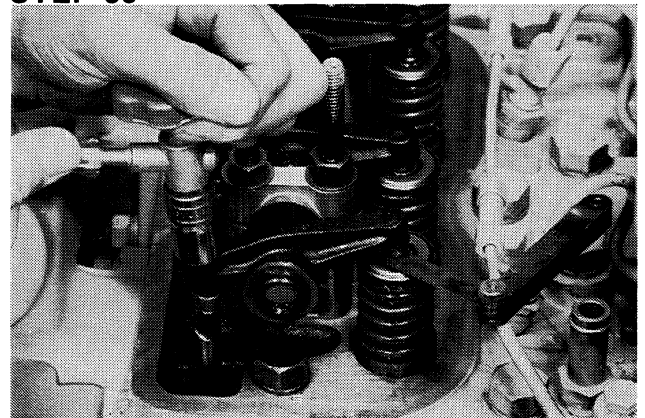

Check and adjust the intake and exhaust valves as the arrows show below. Then, tighten the locking nut to a torque of 20 to 25 ft. lbs. (27 to 34 Nm) (2.7 to 3.4 kgm).

Valve Clearance:

INTAKE VALVES - 0.015" (0.381 mm)

EXHAUST VALVES - 0.025" (0.635 mm)

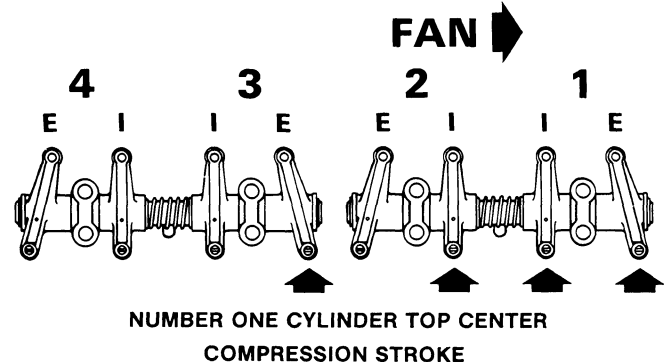

**STEP 40**

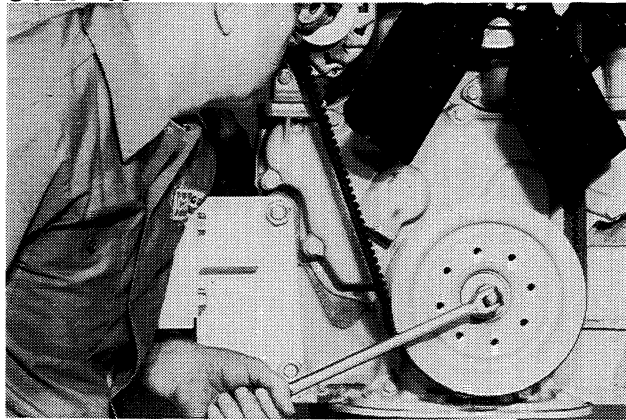

Turn the engine over one complete revolution and align the timing pointer with the Top Center mark on the crankshaft pulley.

Check and adjust the intake and exhaust valves as the arrows show below. Then, tighten the locking nuts to a torque of 20 to 25 ft. lbs. (27 to 34 Nm)(2.7 to 3.4 kgm).

Valve Clearance:

INTAKE VALVES - 0.015" (0.381 mm)

EXHAUST VALVES - 0.025" (0.635 mm)

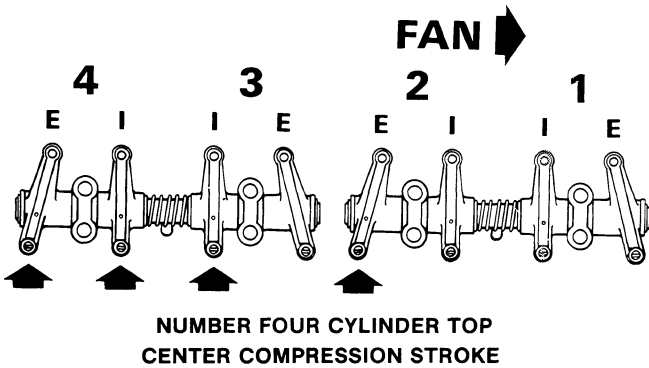

**STEP 41**

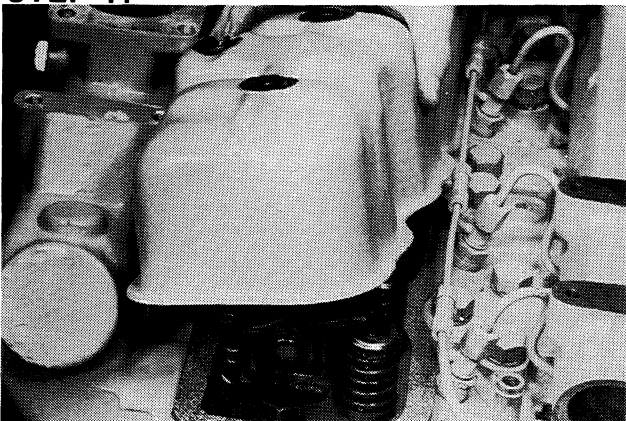

Install the cylinder head covers.

**NOTE:** Check the cover gasket and replace if necessary.

**STEP 42**

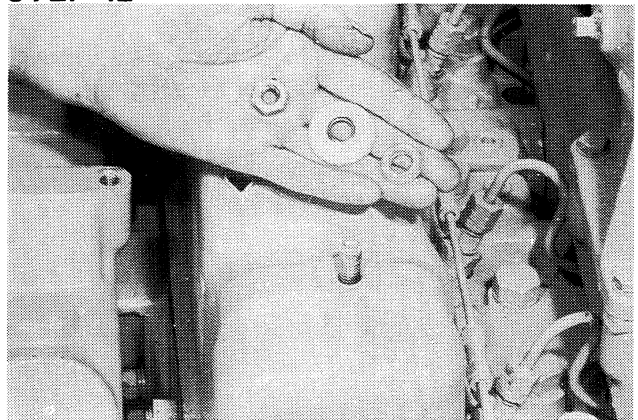

Install the seals, washers and nuts.

**STEP 43**

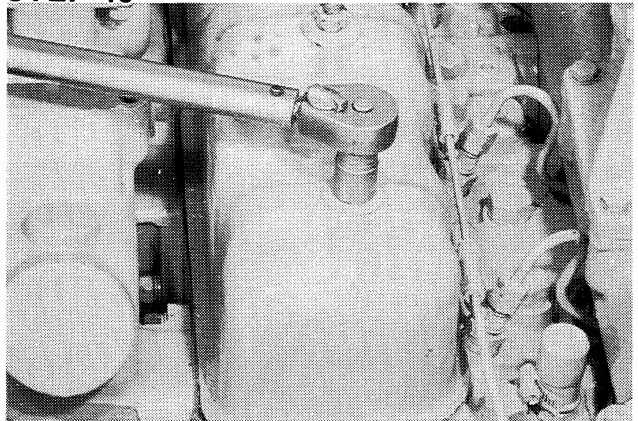

Tighten the valve cover nuts to a torque of 8 to 10 ft. lbs. (11 to 14 Nm)(1.1 to 1.4 kgm).

**STEP 44**

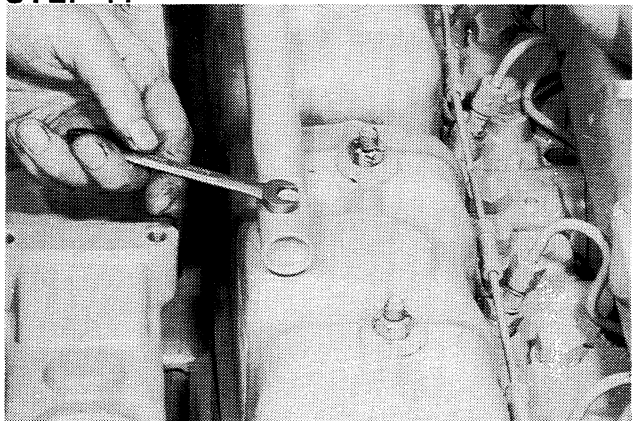

Install the breather tube and gaskets.

## Checking The Nozzle Spray Pattern And The Engine Compression

### 17MM NOZZLES

#### Nozzle Removal

##### STEP 45

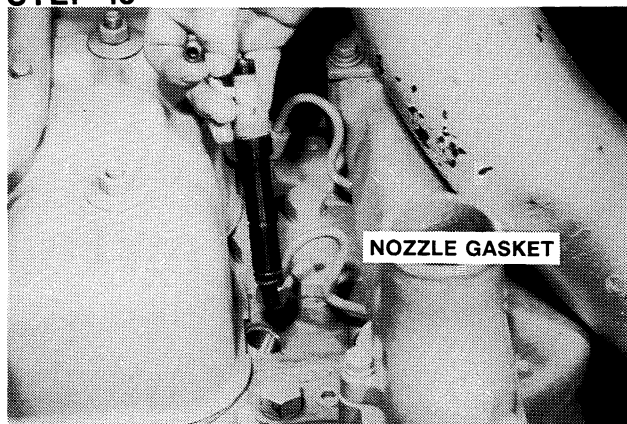

Remove and test each fuel injector. See Section 3213 of the Service Manual for removal and testing. Do a compression test on each cylinder before installing the fuel injector.

**IMPORTANT:** *Make sure that the nozzle gaskets are not left in the bore.*

#### Compression Check

##### STEP 46

There are two methods of checking the compression pressure. The two methods are the crank method and the engine running method. The engine must be at operating temperature for either method used.

1. CRANK METHOD: Remove all the injectors.
2. RUNNING METHOD: Disconnect the high pressure fuel line and the leak off line from the Number One injector. Send the fuel from the lines back to the fuel tank or a clean container. Repeat for each cylinder.



**CAUTION** *Before cranking engine, make sure all operating controls are in neutral, brakes are set and wheels are securely blocked.*

##### STEP 47

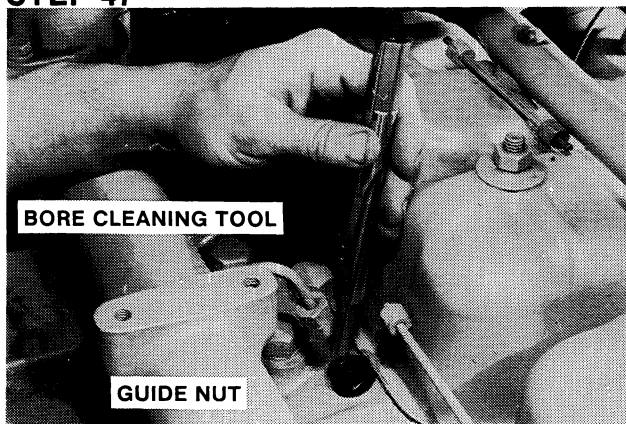

Clean the cylinder head injector bore using a bore cleaning tool with a guide nut (CAS-1411).

##### STEP 48

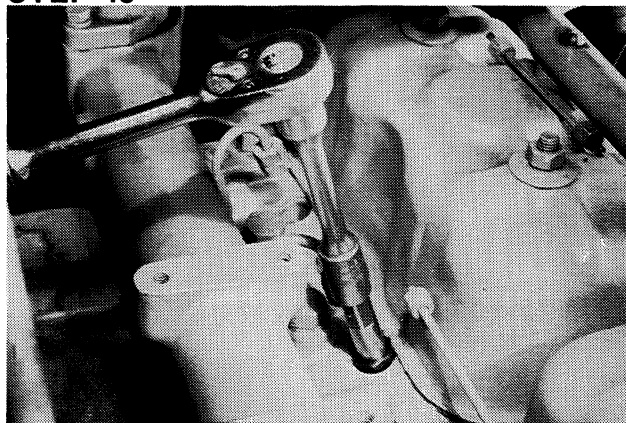

Turn the tool clockwise. The tool will not be kept sharp if counterclockwise rotation is used. Clean the bore with air under pressure, or with the fuel injector removed, turn the engine over to remove the particles.

**STEP 49**

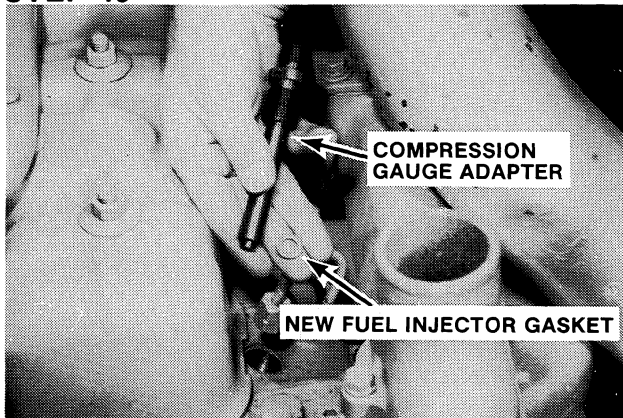

Install the compression gauge adapter (CAS-1410) and a new fuel injector gasket in the cylinder head.

**STEP 50**

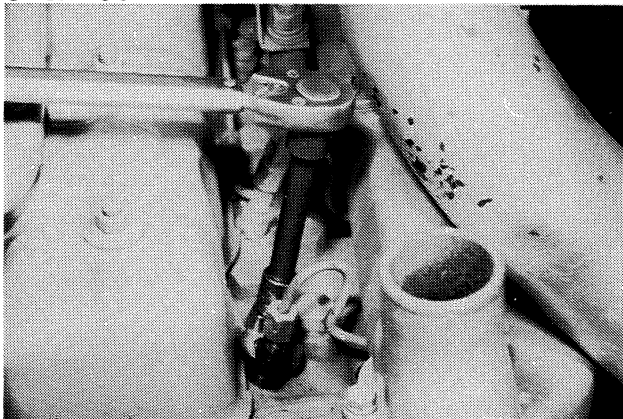

Tighten the adapter to a torque of 35 to 42 ft. lbs. (48 to 57 Nm)(4.8 to 5.7 kgm).

**STEP 51**

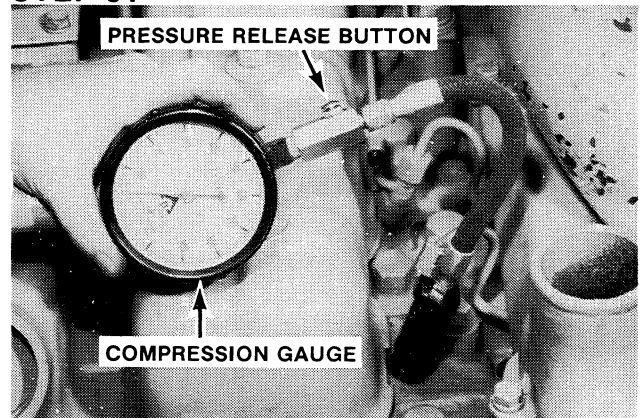

Connect the compression gauge (70-7003) to the adapter.

**NOTE:** Take several compression readings on each cylinder using the pressure release button to decrease the gauge pressure. See the chart on this page.

	<b>ENGINE SPEED</b>	<b>NORMAL COMPRESSION PRESSURE</b>	<b>PERMITTED CHANGES BETWEEN CYLINDERS</b>
<b>CRANK</b>	<b>APPROXIMATELY 200 RPM UNTIL COMPRESSION GAUGE BECOMES CONSTANT</b>	<b>400 PSI* (2 758 kPa) (27.58 bar)</b>	<b>25 PSI (172 kPa) (1.72 bar)</b>
<b>RUNNING</b>	<b>800 RPM</b>	<b>480 PSI* (3 310 kPa) (33.10 bar)</b>	<b>20 PSI (138 kPa) (1.38 bar)</b>
<p><b>*NOTE:</b> A 4% REDUCTION IN PSI MUST BE PERMITTED FOR EVERY 1000 FT. (304.8m) ABOVE SEA LEVEL.</p>			

**STEP 52**

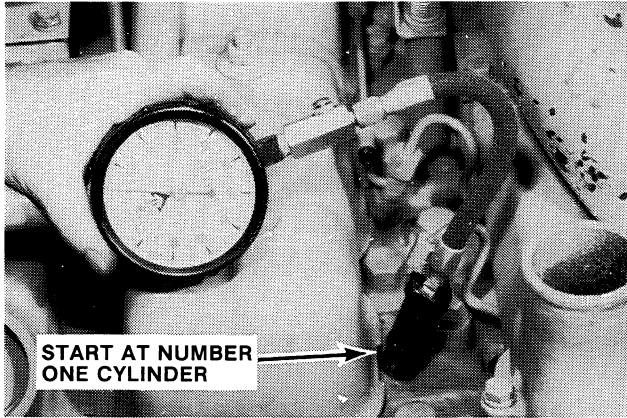

When checking the compression, using the crank method, start at the Number One cylinder and continue down the line (Number 2, 3, 4). Then, check again the Number One cylinder after finishing the last cylinder, because compression can change because of a weak battery.

**STEP 53**

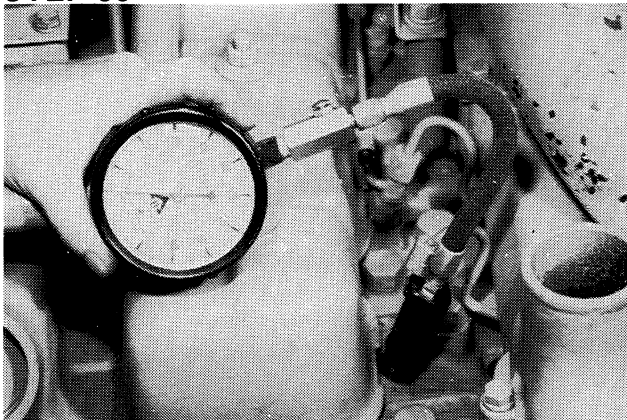

It is very important that all cylinder pressures be approximately the same. See the chart under Step 51 for permitted compression pressure changes.

More than normal compression is an indication of carbon deposits. Below normal compression is an indication of a valve that leaks or too much ring clearance.

**NOTE:** To make an easy test when a compression leak is shown, put oil in the cylinder and check the compression again. If the pressure goes up to near normal, then the compression loss is past the rings. Very little change in compression is an indication of leakage past the valves.

**STEP 54**

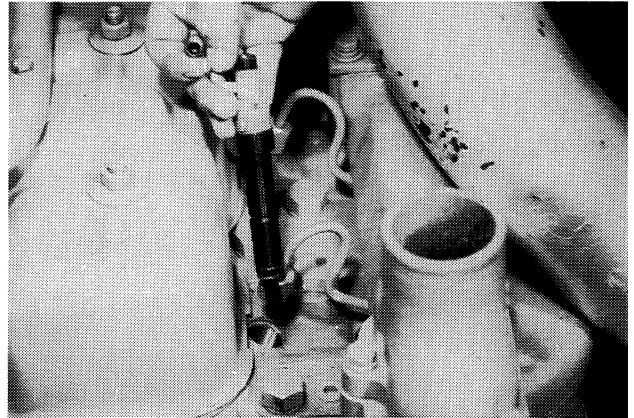

Install the fuel injectors and new gaskets. See Fuel Injection Section of the Service Manual for installation.

**IMPORTANT:** Make sure that the nozzle gasket that was used with the compression gauge adapter is not left in the nozzle bore.

**Cleaning The Fuel Filters**

**STEP 55**

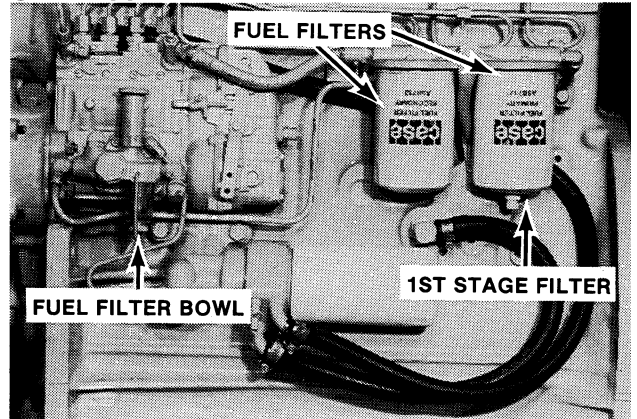

Clean and service the fuel system and filters. See Fuel System and Filters Section of the Service Manual for correct procedure.

## Cleaning The Air Cleaner

### STEP 56

See Air Cleaner Section in this Service Manual for cleaning the air cleaner system.

## Timing The Injection Pump

### STEP 57

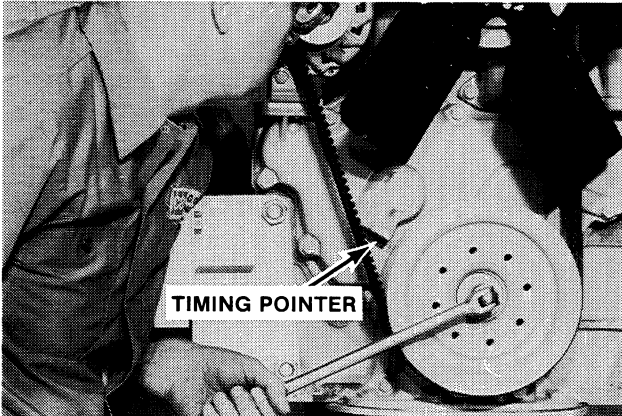

Turn the engine over until the timing pointer is aligned with the Top Center timing mark on the crankshaft pulley.

### STEP 58

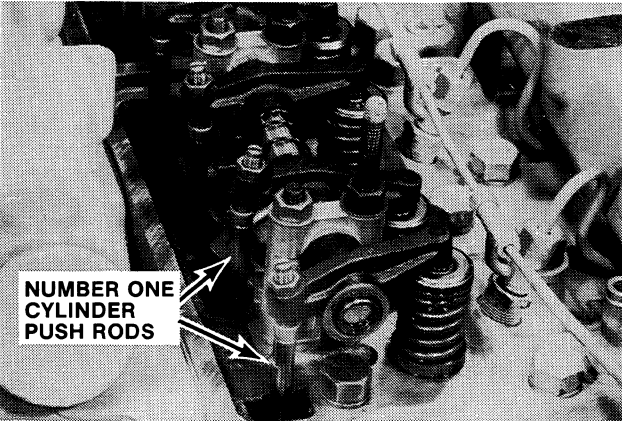

Check the push rods on the Number One Cylinder for looseness. If the push rods are loose, the Number One cylinder is at Top Center on the compression stroke. If the push rods are tight, turn the engine over one complete revolution and align the timing pointer with the Top Center mark on the crankshaft pulley.

### STEP 59

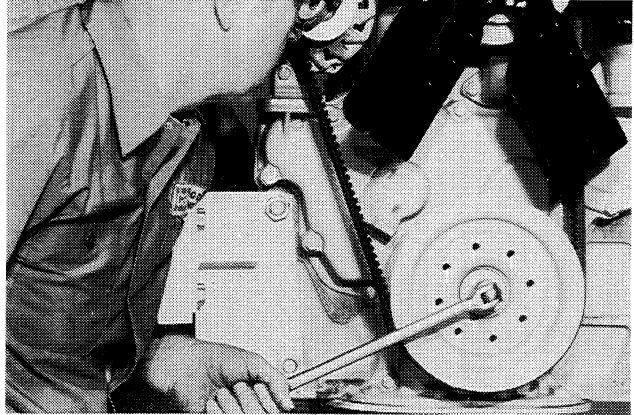

Turn the engine over counterclockwise to the 35 degree mark. Then turn the engine over clockwise to the given fuel pump timing.

**NOTE:** See the engine decal on the cylinder head cover or General Engine Specifications Section of the Service Manual for the fuel pump timing.

### STEP 60

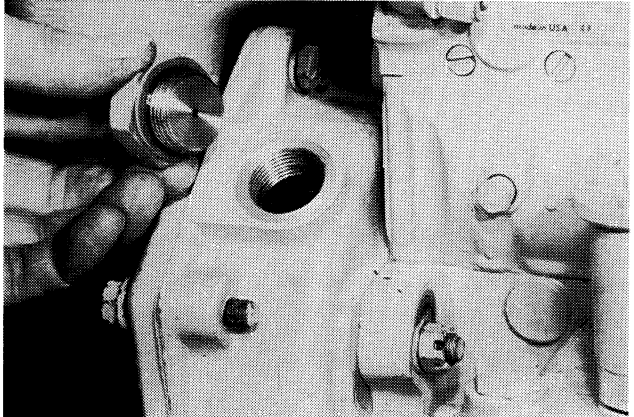

Remove the plug from the timing gear cover.

**STEP 61**

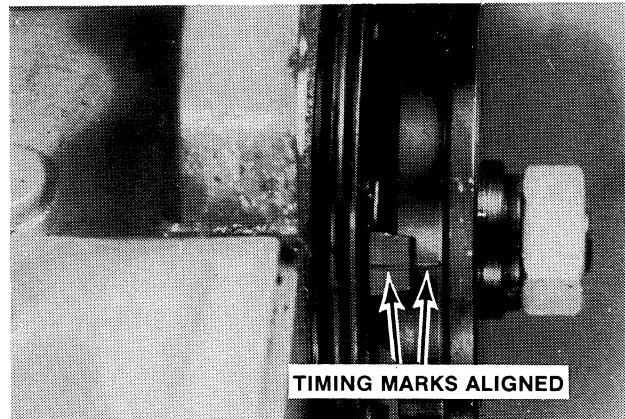
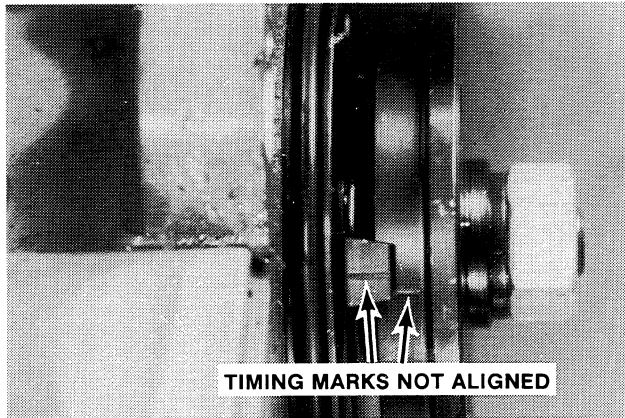
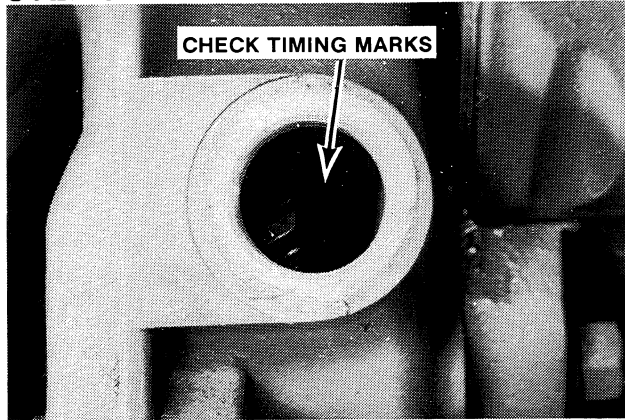

Check the timing marks. If the marks are not aligned, go to the next Step. If the marks are aligned, then the pump is in time.

**STEP 62**

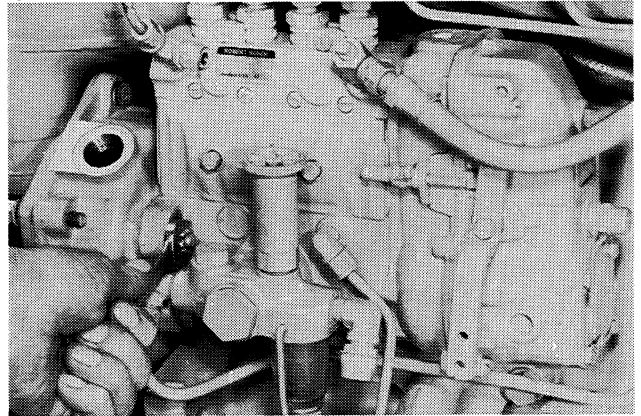

Loosen the four pump mounting nuts.

**STEP 63**

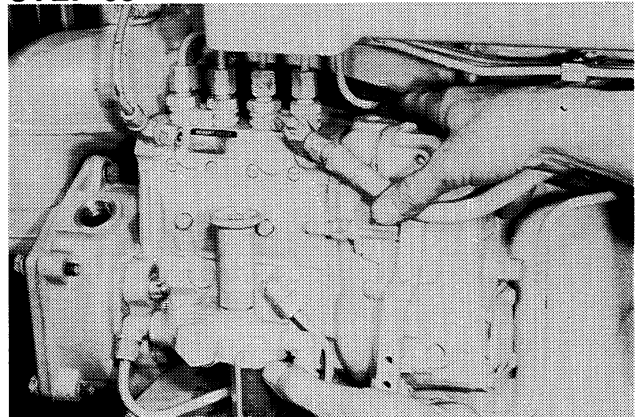

Move the pump toward or away from the engine until the timing marks are aligned.



**Suggest:**

**If the above button click is invalid.**

**Please download this document**

**first, and then click the above link**

**to download the complete manual.**

**Thank you so much for reading**

**STEP 64**

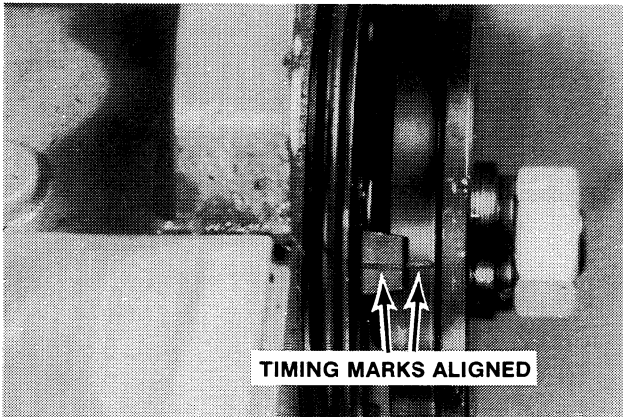
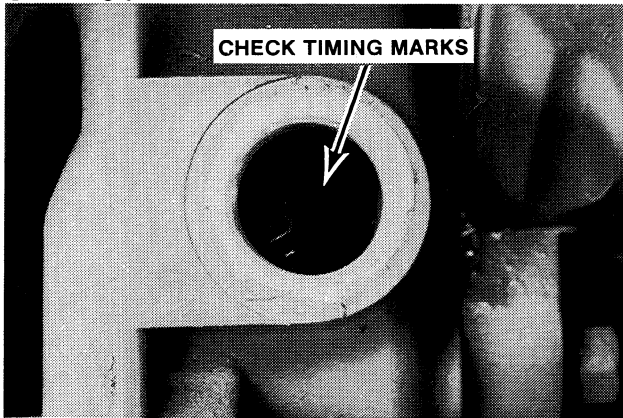

Timing marks aligned for correct timing.

**STEP 65**

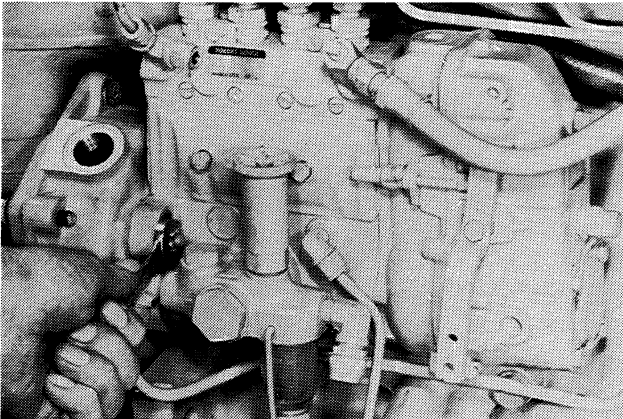

Tighten the pump mounting nuts to a torque of 35 to 42 ft. lbs. (48 to 57 Nm)(4.8 to 5.7 kgm).

**STEP 66**

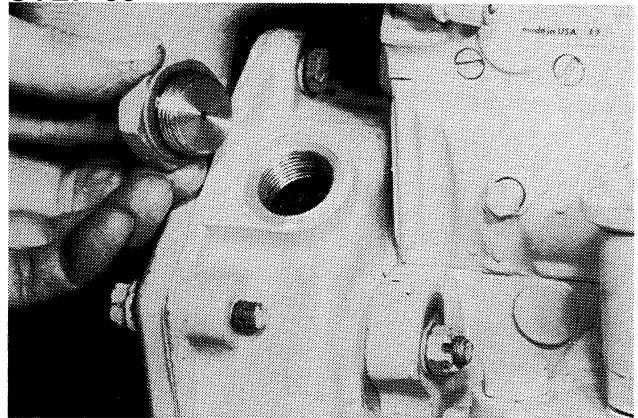

Install the plug and washer in the timing gear cover.

**Adjusting The Governed Speed**

**STEP 67**

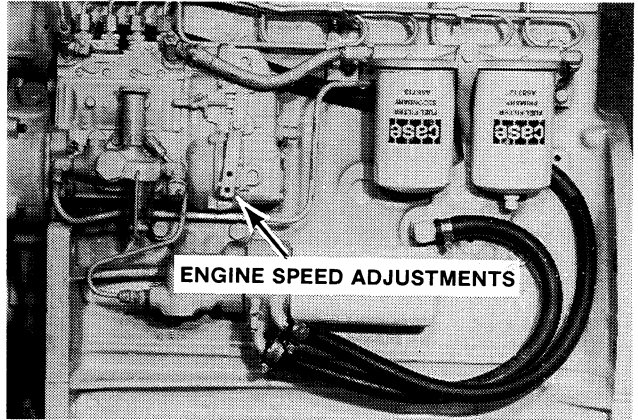

Check and adjust the engine governed speed as shown in Section 3012 of the Service Manual.

**<https://www.ebooklibonline.com>**

Hello dear friend!

Thank you very much for reading.

Enter the link into your browser.

The full manual is available for immediate download.

**<https://www.ebooklibonline.com>**