

**721F**  
**Tier 4**  
Wheel Loader

**SERVICE MANUAL**

**Print number 84488413**

1st edition English  
April 2011



**721F Wheel Loader  
Service Manual  
84488413**

**Table of Contents**

Description	Section No.
<b>General</b>	
General Torque Specifications	1001
Fluids and Lubricants	1002
Metric Conversion Chart	1003
<b>Engines</b>	
Engine and Radiator Removal and Installation	2000
Stall Tests	2002
After Cooler	2003
Engine Intake Air Filtration	2010
SCR System Sensors	2020
SCR Catalyst	2030
Engine Intake Temperature/Humidity Sensor	2040
DEF/ADBLUE Heater Control Valve	2050
DEF/ADBLUE DNOx Supply Module	2060
DEF/ADBLUE Dosing Injector	2070
DEF/ADBLUE Supply Tank	2080
DEF/ADBLUE Supply Tank Level and Temperature Sensor/Pick-up and Heater	2090
DEF/ADBLUE Supply Filters	2100
For Engine Repair, See the Engine Service Manual (sold separately)	84392428
<b>Fuel System</b>	
For Fuel System Repair, See the Engine Service Manual (sold separately)	84392428
<b>Electrical</b>	
Removal and Installation of Starter and Alternator	4001
Electrical Specifications and Troubleshooting	4002
Batteries	4003
Instrument Cluster	4005

**721F Wheel Loader  
Service Manual  
84488413**

**Table of Contents**

Description	Section No.
<b>Steering</b>	
Removal and Installation of Steering Components	5001
Steering Specifications, Pressure Checks, and Troubleshooting	5002
Steering Cylinders	5005
Center Pivot	5006
Auxiliary Steering Motor and Pump	5008
Joystick Steering System (JSS)	5009
<b>Power Train</b>	
Removal and Installation of Power Train Components	6001
Transmission Specifications, Pressure Checks, and Troubleshooting	6002
4 & 5 Speed Transmission	6003
Multitrac MT-L 3705 II / 3085 II / 3095 II Axles	6004
Drive Shafts, Center Bearing, and Universal Joints	6005
Wheels and Tires	6006
<b>Brakes</b>	
Removal and Installation of Brake Components	7001
Hydraulic Brake Troubleshooting	7002
Brake Pump	7003
Brake Accumulators	7004
Parking Brake	7008
<b>Hydraulics</b>	
Removal and Installation of Hydraulic Components	8001
Hydraulic Specifications, Troubleshooting, and Pressure Checks	8002
Cleaning the Hydraulic System	8003
Hydraulic Pump	8004

**<https://www.ebooklibonline.com>**

Hello dear friend!

Thank you very much for reading.

Enter the link into your browser.

The full manual is available for immediate download.

**<https://www.ebooklibonline.com>**

**721F Wheel Loader  
Service Manual  
84488413**

**Table of Contents**

Description	Section No.
<b>Hydraulics (continued)</b>	
Loader Control Valve	8005
Cylinders	8006
Coupler Solenoid Locking Valve	8007
Ride Control Accumulator	8013
Ride Control Valve	8014
<b>Mounted Equipment</b>	
Air Conditioning Troubleshooting and System Checks For Systems with HFC-134a Refrigerant	9002
Air Conditioner System Service	9003
Removal And Installation Of Air Conditioning And Heater Components	9004
Loader	9006
Roll Over Protective Structure (ROPS), Cab Structural Frame (CSF)	9007
Cab Glass Installation	9010
Rear View Camera Installation and Removal	9020
<b>Electrical Schematic Foldouts and Hydraulic Schematic Foldout</b>	<b>In Rear Pocket</b>

# Section 1001

**GENERAL TORQUE SPECIFICATIONS**

## TORQUE SPECIFICATIONS - DECIMAL HARDWARE

Use the torques in this chart when special torques are not given. These torques apply to fasteners with both UNC and UNF threads as received from suppliers dry, or when lubricated with engine oil. Not applicable if special graphities, Molydisulfide greases, or other extreme pressure lubricants are used.

Grade 5 Bolts, Nuts, and Studs		
		
Size	Pound-Inches	Newton metres
1/4 inch	108 to 132	12 to 15
5/16 inch	204 to 252	23 to 28
3/8 inch	420 to 504	48 to 57
Size	Pound-Feet	Newton metres
7/16 inch	54 to 64	73 to 87
1/2 inch	80 to 96	109 to 130
9/16 inch	110 to 132	149 to 179
5/8 inch	150 to 180	203 to 244
3/4 inch	270 to 324	366 to 439
7/8 inch	400 to 480	542 to 651
1.0 inch	580 to 696	787 to 944
1-1/8 inch	800 to 880	1085 to 1193
1-1/4 inch	1120 to 1240	1519 to 1681
1-3/8 inch	1460 to 1680	1980 to 2278
1-1/2 inch	1940 to 2200	2631 to 2983

Grade 8 Bolts, Nuts, and Studs		
		
Size	Pound-Inches	Newton metres
1/4 inch	144 to 180	16 to 20
5/16 inch	288 to 348	33 to 39
3/8 inch	540 to 648	61 to 73
Size	Pound-Feet	Newton metres
7/16 inch	70 to 84	95 to 114
1/2 inch	110 to 132	149 to 179
9/16 inch	160 to 192	217 to 260
5/8 inch	220 to 264	298 to 358
3/4 inch	380 to 456	515 to 618
7/8 inch	600 to 720	814 to 976
1.0 inch	900 to 1080	1220 to 1465
1-1/8 inch	1280 to 1440	1736 to 1953
1-1/4 inch	1820 to 2000	2468 to 2712
1-3/8 inch	2380 to 2720	3227 to 3688
1-1/2 inch	3160 to 3560	4285 to 4827

**NOTE:** Use thick nuts with Grade 8 bolts.

## TORQUE SPECIFICATIONS - METRIC HARDWARE

Use the following torques when specifications are not given.

These values apply to fasteners with coarse threads as received from supplier, plated or unplated, or when lubricated with engine oil. These values do not apply if graphite or Molydisulfide grease or oil is used.

<b>Grade 8.8 Bolts, Nuts, and Studs</b>		
		
Size	Pound-Inches	Newton metres
M4	24 to 36	3 to 4
M5	60 to 72	7 to 8
M6	96 to 108	11 to 12
M8	228 to 276	26 to 31
M10	456 to 540	52 to 61
Size	Pound-Feet	Newton metres
M12	66 to 79	90 to 107
M14	106 to 127	144 to 172
M16	160 to 200	217 to 271
M20	320 to 380	434 to 515
M24	500 to 600	675 to 815
M30	920 to 1100	1250 to 1500
M36	1600 to 1950	2175 to 2600

<b>Grade 10.9 Bolts, Nuts, and Studs</b>		
		
Size	Pound-Inches	Newton metres
M4	36 to 48	4 to 5
M5	84 to 96	9 to 11
M6	132 to 156	15 to 18
M8	324 to 384	37 to 43
Size	Pound-Feet	Newton metres
M10	54 to 64	73 to 87
M12	93 to 112	125 to 150
M14	149 to 179	200 to 245
M16	230 to 280	310 to 380
M20	450 to 540	610 to 730
M24	780 to 940	1050 to 1275
M30	1470 to 1770	2000 to 2400
M36	2580 to 3090	3500 to 4200

### Grade 12.9 Bolts, Nuts, and Studs

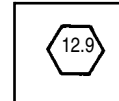

Usually the torque values specified for grade 10.9 fasteners can be used satisfactorily on grade 12.9 fasteners.

## TORQUE SPECIFICATIONS - STEEL HYDRAULIC FITTINGS

<b>37 Degree Flare Fitting</b>			
Tube OD Hose ID	Thread Size	Pound- Inches	Newton metres
1/4 inch 6.4 mm	7/16-20	72 to 144	8 to 16
5/16 inch 7.9 mm	1/2-20	96 to 192	11 to 22
3/8 inch 9.5 mm	9/16-18	120 to 300	14 to 34
1/2 inch 12.7 mm	3/4-16	180 to 504	20 to 57
5/8 inch 15.9 mm	7/8-14	300 to 696	34 to 79
Tube OD Hose ID	Thread Size	Pound- Feet	Newton metres
3/4 inch 19.0 mm	1-1/16-12	40 to 80	54 to 108
7/8 inch 22.2 mm	1-3/16-12	60 to 100	81 to 135
1.0 inch 25.4 mm	1-5/16-12	75 to 117	102 to 158
1-1/4 inch 31.8 mm	1-5/8-12	125 to 165	169 to 223
1-1/2 inch 38.1 mm	1-7/8-12	210 to 250	285 to 338

<b>Straight Threads with O-ring</b>			
Tube OD Hose ID	Thread Size	Pound- Inches	Newton metres
1/4 inch 6.4 mm	7/16-20	144 to 228	16 to 26
5/16 inch 7.9 mm	1/2-20	192 to 300	22 to 34
3/8 inch 9.5 mm	9/16-18	300 to 480	34 to 54
1/2 inch 12.7 mm	3/4-16	540 to 804	57 to 91
Tube OD Hose ID	Thread Size	Pound- Feet	Newton metres
5/8 inch 15.9 mm	7/8-14	58 to 92	79 to 124
3/4 inch 19.0 mm	1-1/16-12	80 to 128	108 to 174
7/8 inch 22.2 mm	1-3/16-12	100 to 160	136 to 216
1.0 inch 25.4 mm	1-5/16-12	117 to 187	159 to 253
1-1/4 inch 31.8 mm	1-5/8-12	165 to 264	224 to 357
1-1/2 inch 38.1 mm	1-7/8-12	250 to 400	339 to 542

<b>Split Flange Mounting Bolts</b>		
Size	Pound- Inches	Newton metres
5/16-18	180 to 240	20 to 27
3/8-16	240 to 300	27 to 34
7/16-14	420 to 540	47 to 61
Size	Pound- Feet	Newton metres
1/2-13	55 to 65	74 to 88
5/8-11	140 to 150	190 to 203

# **Section 2000**

**ENGINE AND RADIATOR REMOVAL AND INSTALLATION**

**2000**

## ENGINE

### Removal

#### STEP 1

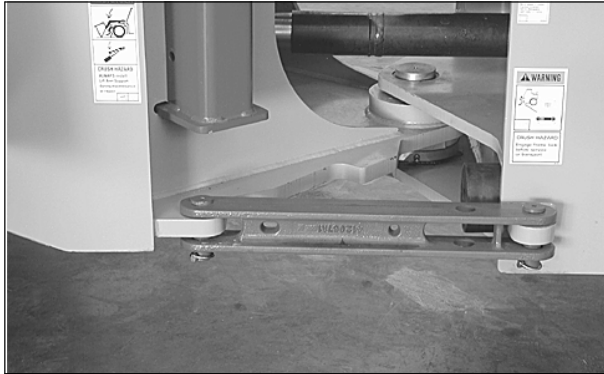

BD03A040

Park machine on a level surface and lower bucket to ground. Put articulation lock in LOCKED position.

#### STEP 2

Stop engine. Actuate brake pedal several times to discharge brake accumulators. Put key switch in ON position and move loader control lever back and forth at least 30 times to release any pressure from hydraulic circuit. Put key switch in OFF position.

#### STEP 3

Slowly loosen the filler cap for hydraulic reservoir to release air pressure in hydraulic reservoir.

#### STEP 4

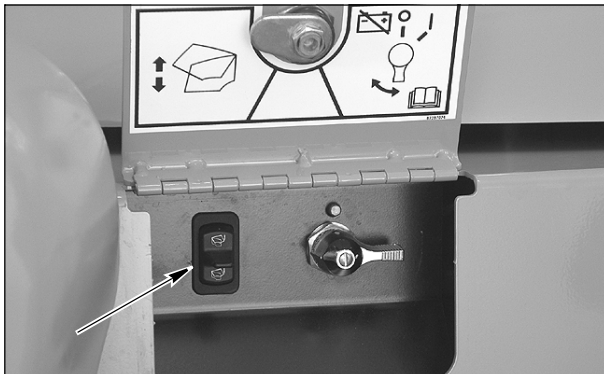

BD06F108

The master and hood raise switch are located by the battery box. Raise the hood with the hood lift motor. Put master disconnect switch in OFF position. Remove both battery covers and disconnect batteries from the machine.

#### STEP 5



BD02N160

Put a 28.4 liter (30 U.S. quart) container below radiator drain. Remove radiator cap. Remove cap and drain coolant into container. Install cap after coolant has drained. Install radiator cap.

#### STEP 6

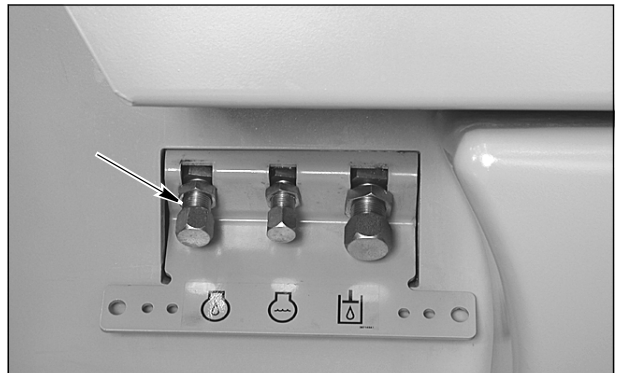

BD02N160

Put a 15.1 liter (16 U.S. quart) container below engine oil drain. Remove cap and drain oil into container. Install cap after oil has drained.

**NOTE:** After draining oil disconnect drain hose from frame for removal with engine.

2000-4

### STEP 7

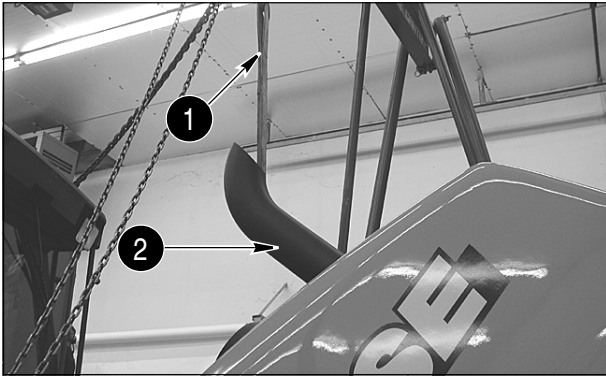

BD03A231

Double up a nylon lifting strap (1) and slide through the exhaust stack (2) on the hood.

### STEP 8

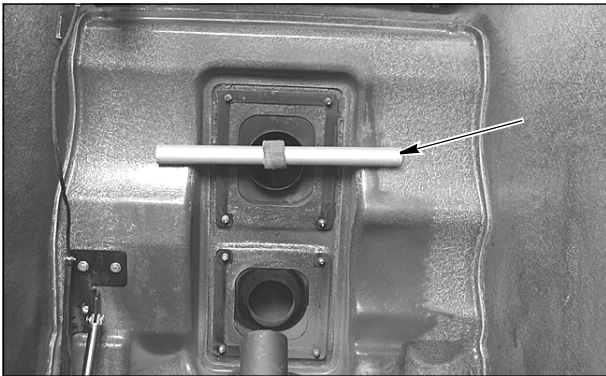

BD03A230

Place a solid steel bar through the strap, raise the hood and release tension on the lifting motor.

### STEP 9

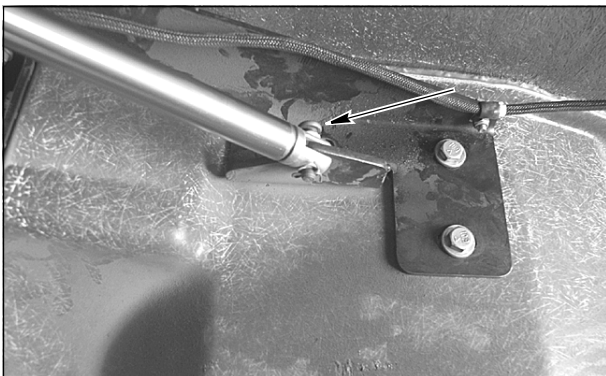

BD03A228

Remove the pin from the top of the lifting motor.

### STEP 10



BD06F109

Tag and disconnect hood wiring harness connector from rear chassis wiring harness connector.

### STEP 11

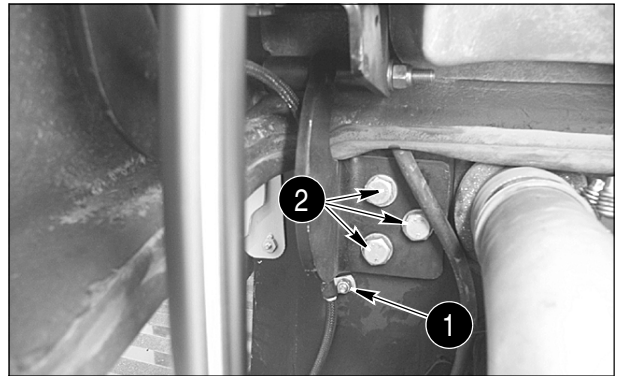

BD03A227

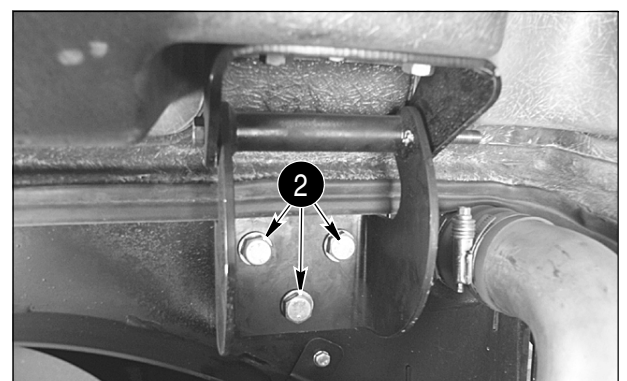

BD03A226

Remove mount bolt (1) and backup alarm wiring harness clamp from cooler housing. Have another person balance the hood and remove the hood hinge mounting bolts (2) from the cooler frame.

**STEP 12**



BD03A232

Carefully raise and remove hood from loader. Lower hood onto suitable platform and disconnect lifting equipment.

**STEP 13**

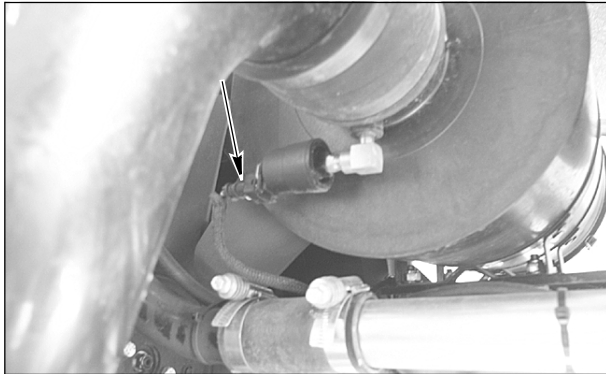

BD03A224

Tag and disconnect engine wiring harness connector from air filter restriction switch.

**STEP 14**

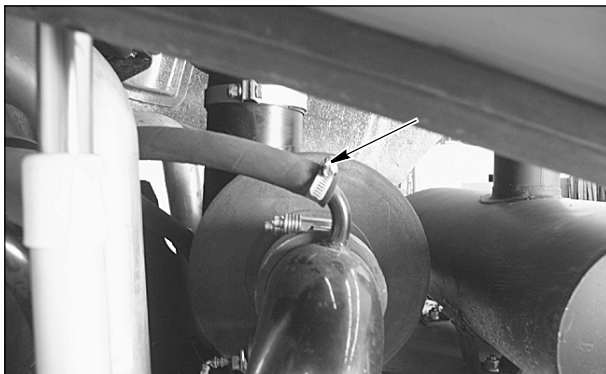

BD03A225

Loosen clamp on air cleaner intake hose and remove the crankcase ventilation hose.

**STEP 15**

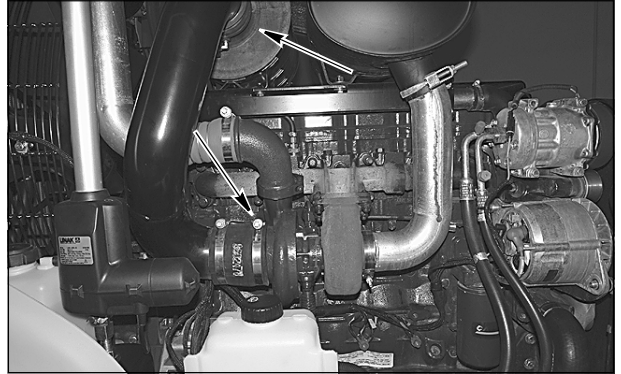

BD06F110

Loosen clamps on turbocharger and air cleaner, remove the intake hose.

**STEP 16**

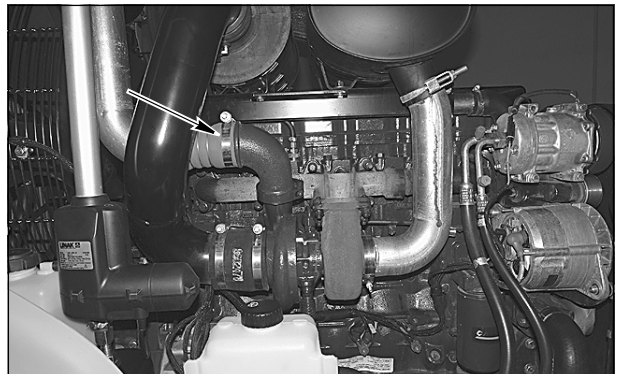

BD06F110

Loosen the clamp on the turbocharger for the after cooler inlet hose.

**STEP 17**



BD03A115

Loosen the clamp on the after cooler and remove the after cooler inlet hose from the machine.

2000-6

### STEP 18

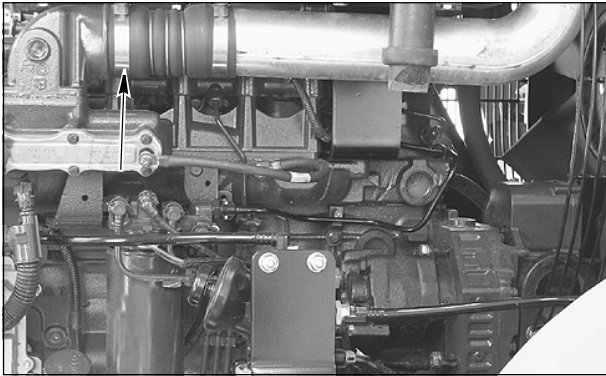

BD06F111

Loosen the clamp on the intake manifold for the after cooler output hose.

### STEP 19



BD03A118

Loosen the clamp on the after cooler and remove the after cooler outlet hose from the machine.

### STEP 20



BD06F110

Loosen the exhaust clamp from the turbocharger.

### STEP 21

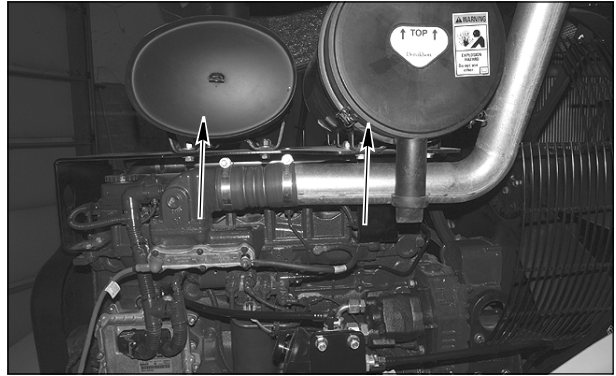

BD06F112

Remove the air cleaner and muffler from the bracket.

### STEP 22

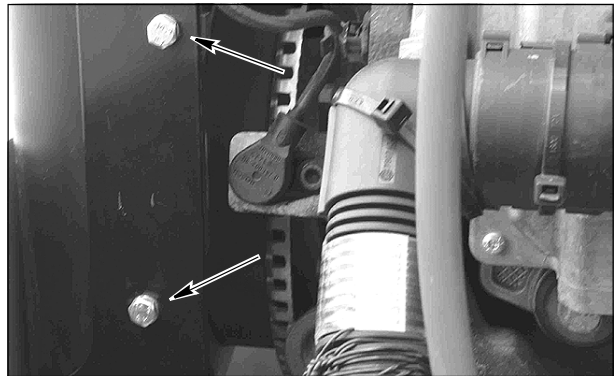

BD06F113

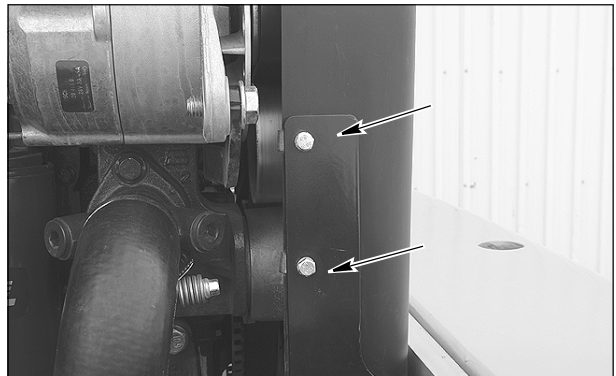

BD06F114

Remove the four mounting bolts from the belt cover, remove the cover.

**NOTE:** After removing the belt cover remove the cover mounting brackets from the machine frame.

**STEP 23**

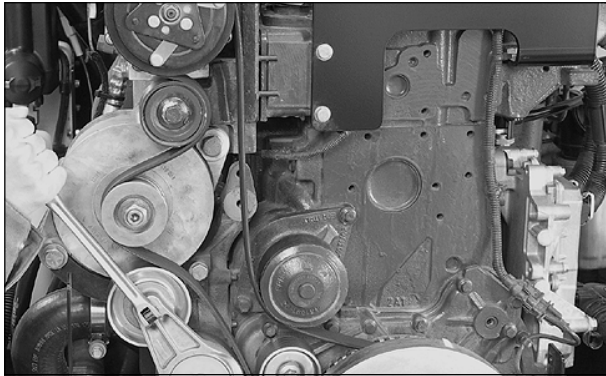

BD06F115

Remove the drive belt from the engine.

**STEP 24**

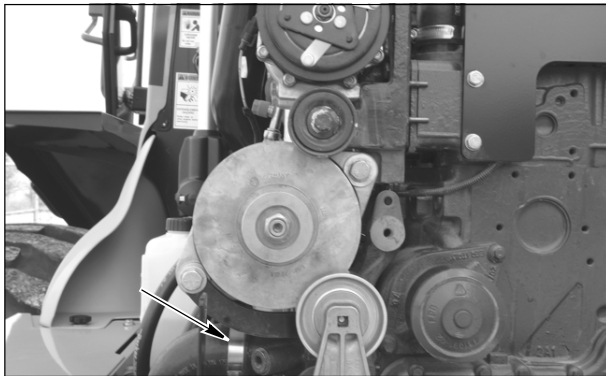

BD06F116

Loosen clamps and remove lower cooler hose from the engine.

**STEP 25**

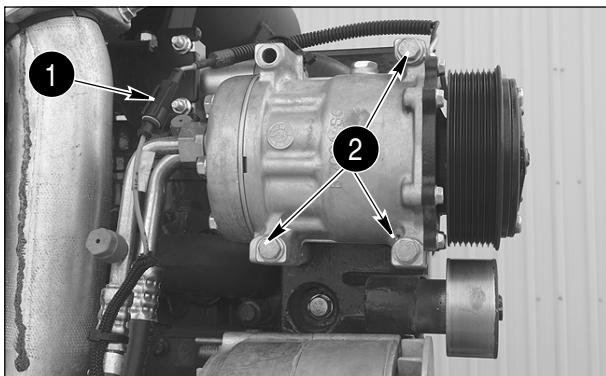

BD06F117

If loader is equipped with air conditioning, identify, tag, and disconnect the engine wiring harness connectors from air compressor clutch connector (1). Remove the three mounting bolts (2) for the compressor and set the compressor on the left battery cover.

**STEP 26**

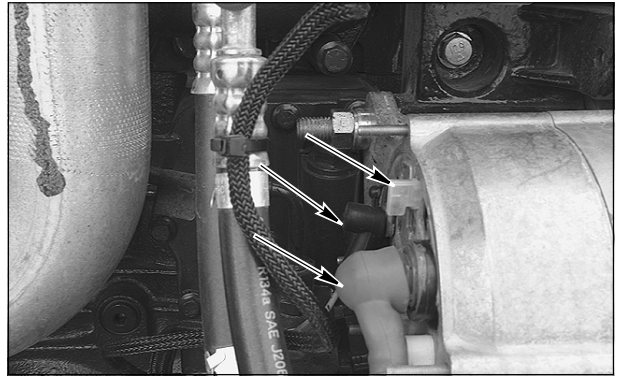

BD06F118

Tag and disconnect the wiring from the alternator.

**STEP 27**

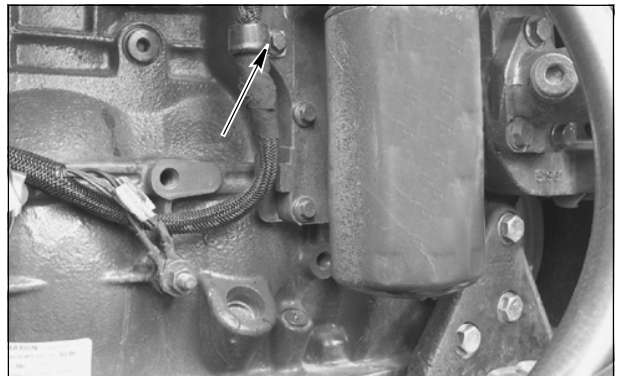

BD06F119

Remove bolt securing wiring harness clamp to engine.

**STEP 28**

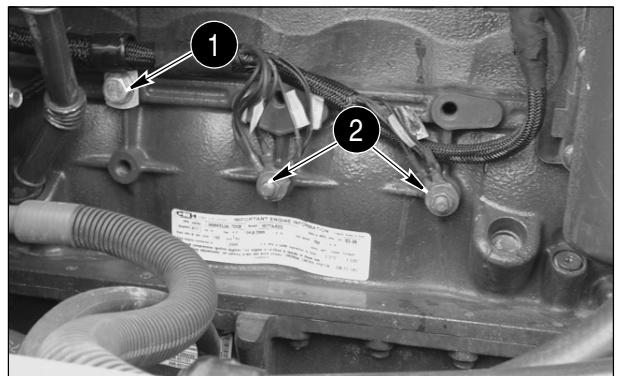

BD06F120

Remove bolt securing wiring harness clamp (1) to the engine. Remove ground wires (2) from the engine.

2000-8

### STEP 29

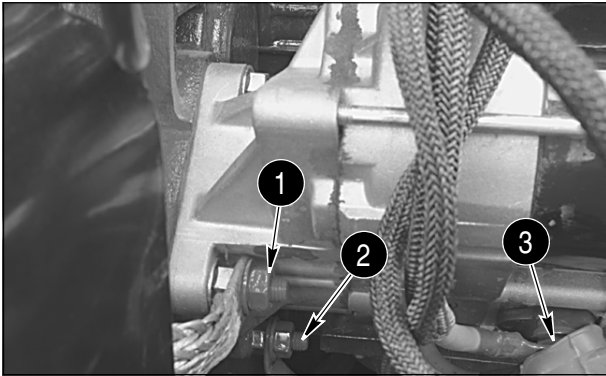

BD06F121

Tag and remove the wires from the starter solenoid (3), remove the ground cable (2), and ground strap (1) from the starter.

**NOTE:** Move the starter cables away from the engine, move the wiring harness away from the engine.

### STEP 30

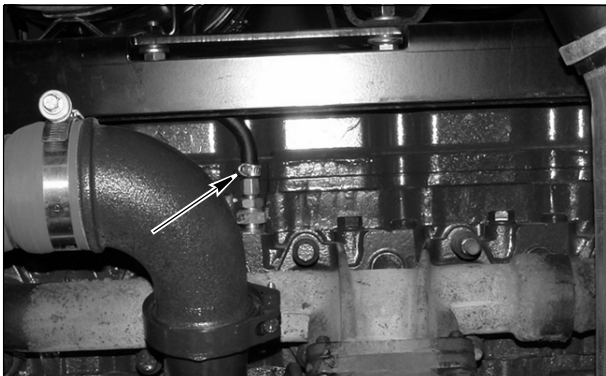

BD06F146

Disconnect the engine coolant vent hose and route to the rear of the engine.

### STEP 31

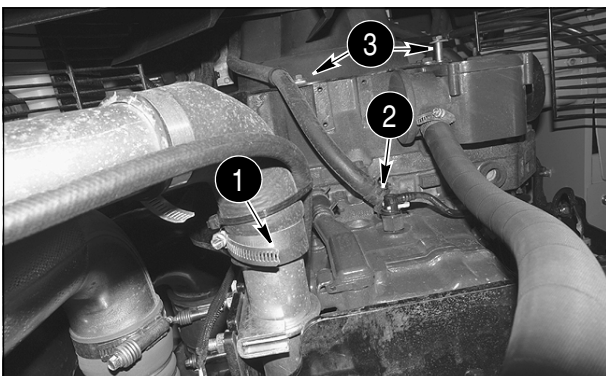

BD06F122

Remove the radiator hose (1) from the rear of the engine, remove the heater hose from the rear of the engine (2), remove the clamp bolts and clamps (3) from the bell housing.

### STEP 32

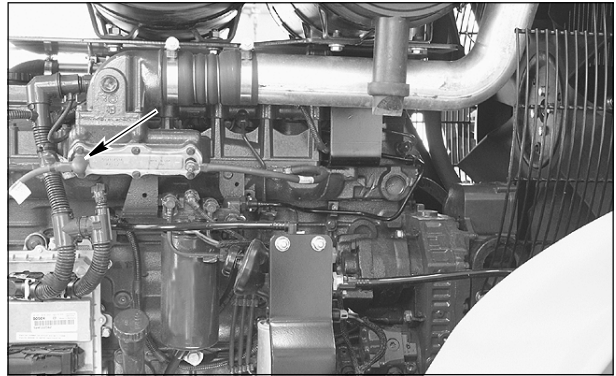

BD06F111

Tag and remove the grid heater cable.

### STEP 33

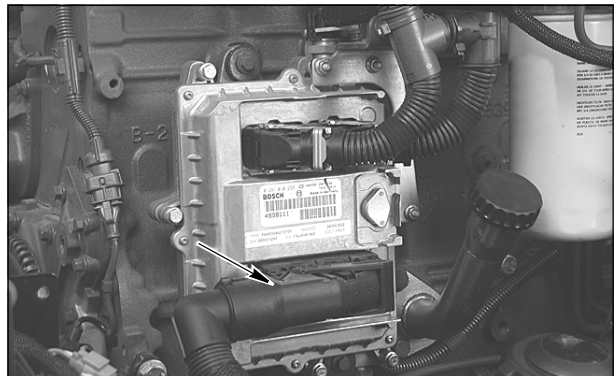

BD03A142

Disconnect the wiring harness from the EDC 7 controller.

**NOTE:** Lifting up on the lever will release the connector from the controller.

### STEP 34

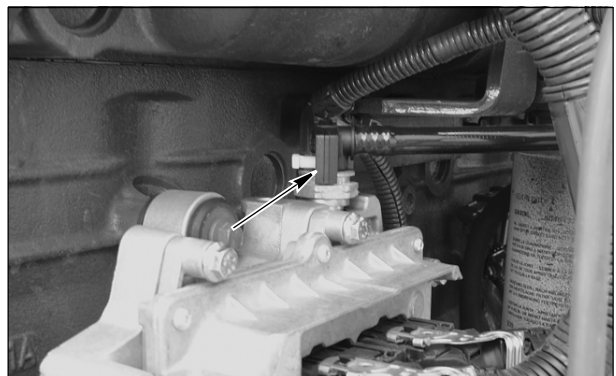

BD06F123

Remove the fuel line from the top of the EDC 7 controller, plug the line and cap the fitting.

**STEP 35**

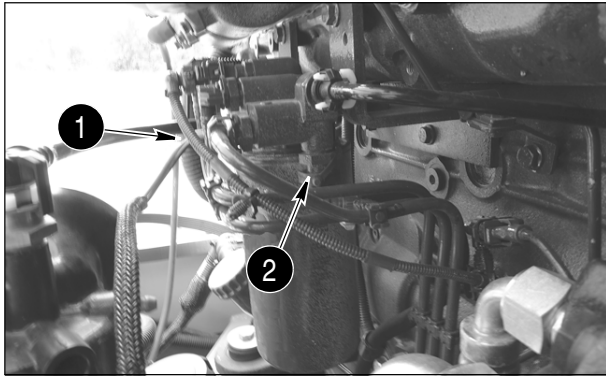

BD06F124

Tag and disconnect the fuel filter heater wires (1), disconnect the fuel line (2) from the fuel filter head, plug the line and cap the fitting.

**STEP 36**

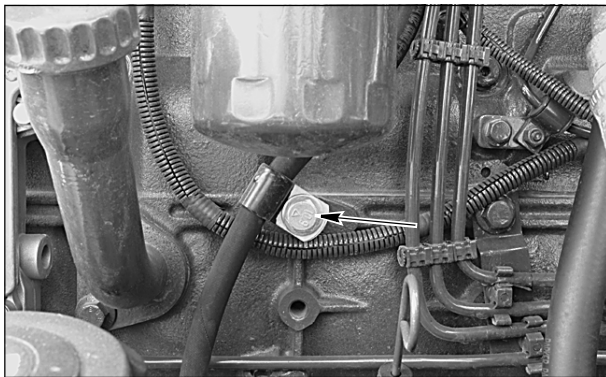

BD06F125

Remove bolt and clamp.

**STEP 37**

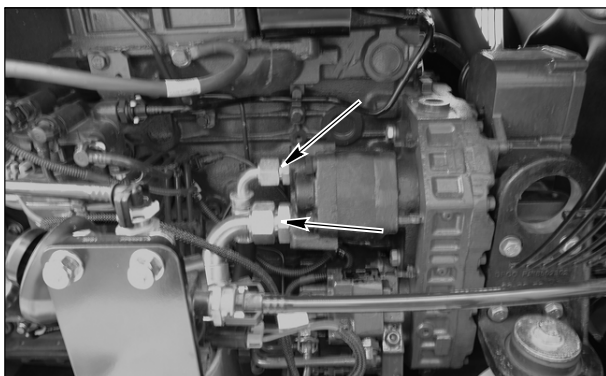

BD06F126

Connect and turn on vacuum pump to hydraulic reservoir. Tag and remove the hydraulic lines from the brake system pump, plug the lines and cap the fittings.

**STEP 38**



BD06F127

Remove the lower cover for the drive shaft.

**STEP 39**

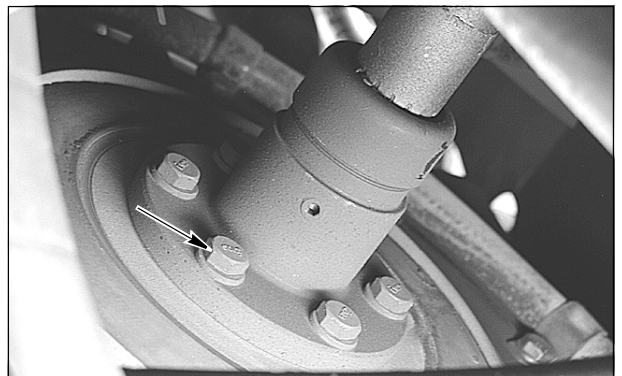

BD03A172

Remove the drive shaft bolts from the flywheel. Move the drive shaft clear of the flywheel.

**STEP 40**

Connect suitable lifting equipment to engine lifting brackets. Take up all slack in lifting equipment. Remove the engine mounting bolts and lift the engine enough to gain access to the drain hose, pull the drain hose with the engine.

**STEP 41**

Slowly raise engine from rear chassis. Be sure all harness connections and hoses have been disconnected and are clear of the engine. Remove engine from machine.

## Installation

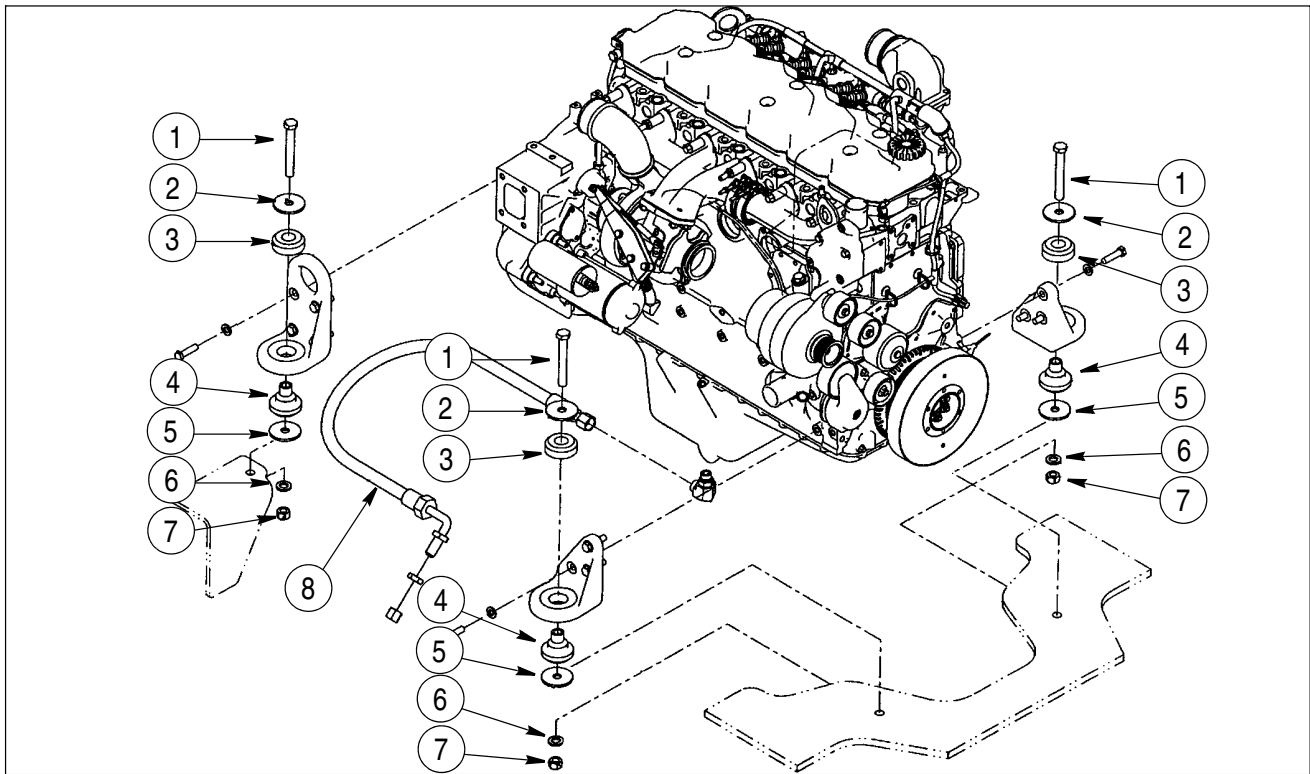

BS03B035

- |                      |                    |           |                          |
|----------------------|--------------------|-----------|--------------------------|
| 1. ENGINE MOUNT BOLT | 3. INSOLATOR UPPER | 5. WASHER | 7. NUT                   |
| 2. WASHER            | 4. INSOLATOR LOWER | 6. WASHER | 8. REMOTE OIL DRAIN HOSE |

### STEP 42

If engine rubber isolators require replacement, remove and discard isolators (3 and 4). Install new rubber isolator (4), then rubber isolator (3).

### STEP 43

Slowly raise engine and move into position over rear chassis. Be sure all harness connections and hoses are out of the way then lower engine. Put washer (5) between front rubber isolator (4) and chassis. Install washer (2), bolt (1), washer (6), and nut (7) in engine isolators. Lower engine into position.

### STEP 44

Tighten engine mounting bolts to a torque of 244 to 298 Nm (180 to 220 lb-ft).

### STEP 45

Disconnect lifting equipment from engine lifting brackets.

### STEP 46

Connect engine oil drain hose to frame bracket.

### STEP 47

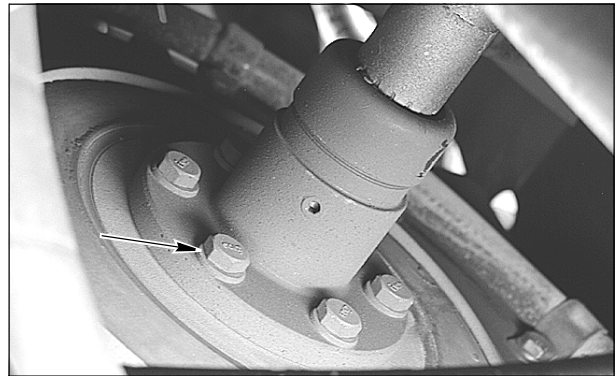

BD03A172

At front of engine, position drive shaft on engine coupling. Install six bolts to secure drive shaft to engine coupling. Tighten the six bolts to a torque of 53 to 62 Nm (39 to 46 lb-ft).

**STEP 48**



BD06F127

Install the lower cover for the drive shaft.

**STEP 49**

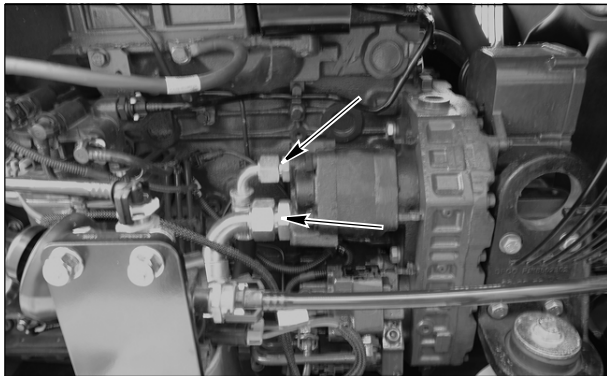

BD06F126

Connect and turn on vacuum pump to the hydraulic reservoir. Remove caps from fittings and plugs from hoses. Connect hoses to brake pump following tags installed during removal. Remove and discard tags. Turn off and disconnect vacuum pump from hydraulic reservoir.

**STEP 50**

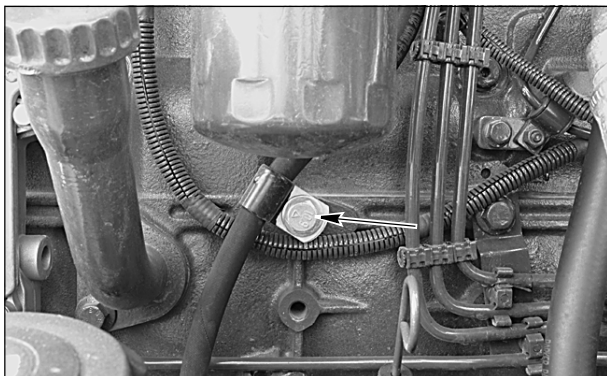

BD06F125

Install bolt and clamp for fuel return hose.

**STEP 51**

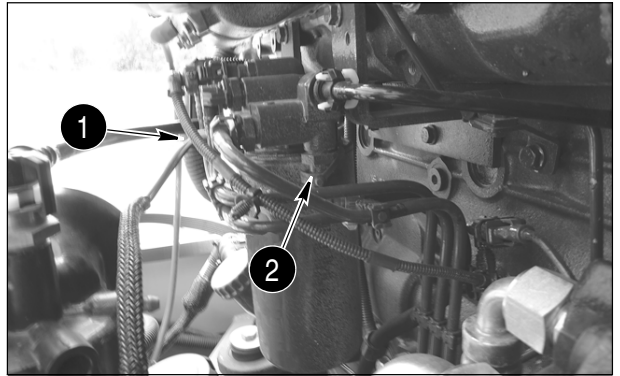

BD06F124

Remove cap from fitting and plug from the hose, connect fuel line (2). Connect fuel filter heater wires (1). Remove and discard tag.

**STEP 52**

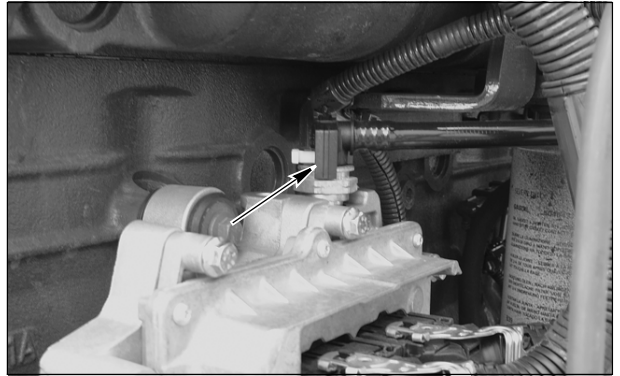

BD06F123

Remove cap from fitting and plug from the hose, connect fuel line to EDC 7.

**STEP 53**

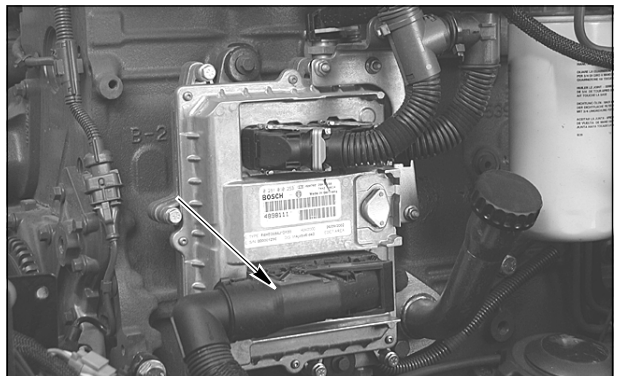

BD03A142

Connect wiring harness to EDC 7 controller.

**NOTE:** Start the connector on the EDC 7 with lever straight out from EDC 7. Use lever to pull connector into position.

2000-12

### STEP 54

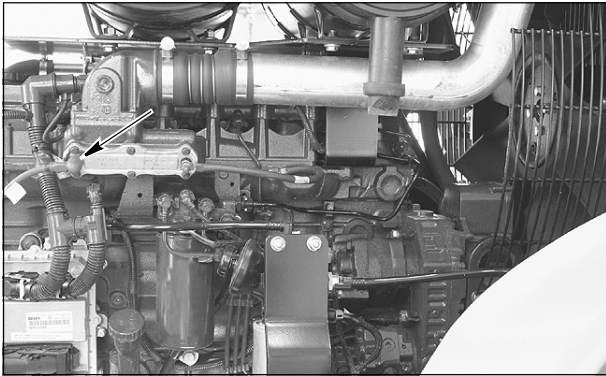

BD06F111

Connect grid heater cable to grid heater. Remove and discard tag.

### STEP 55

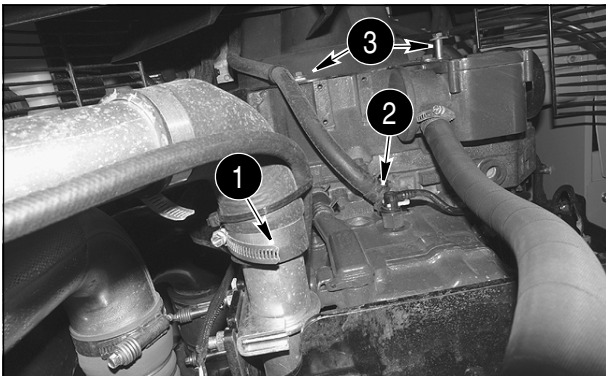

BD06F122

Install the heater hose (2) to the rear of the engine, mount the clamps (3), install the radiator hose (1).

### STEP 56

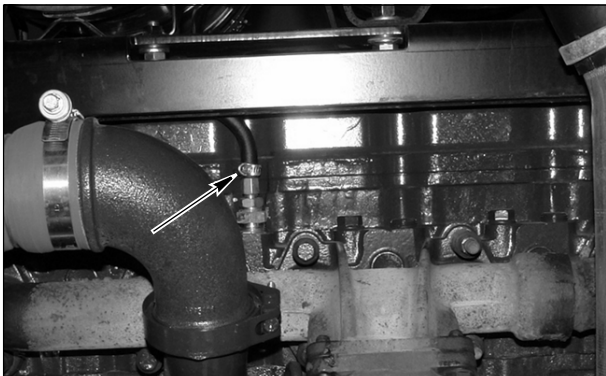

BD06F146

Connect the engine coolant vent hose.

### STEP 57

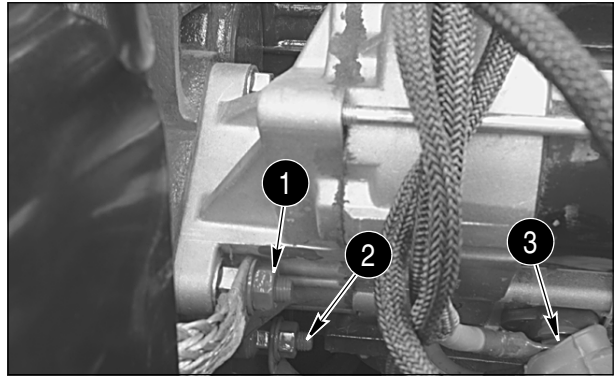

BD06F121

Install the wires to the starter solenoid (3), install the ground cable (2), and ground strap (1) to the starter. Remove and discard tags.

### STEP 58

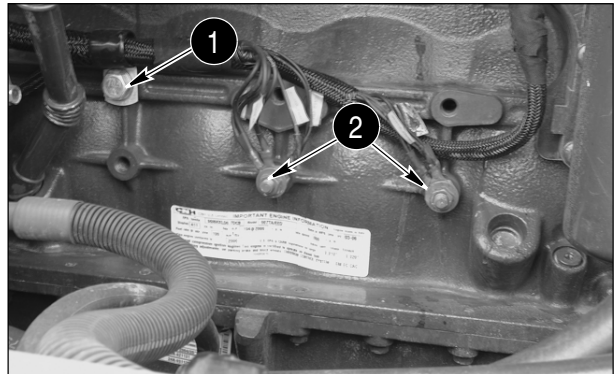

BD06F120

Install bolt securing wiring harness (1) clamp to the engine. Install ground wires (2) to the engine.

### STEP 59



BD06F119

Install bolt securing wiring harness clamp to engine.

**STEP 60**

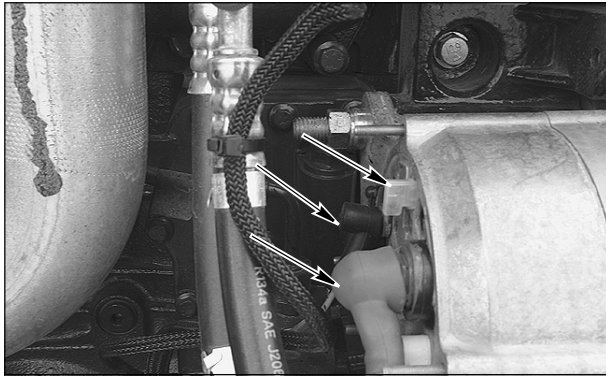

BD06F118

Connect the wiring to the alternator. Remove and discard tags.

**STEP 61**

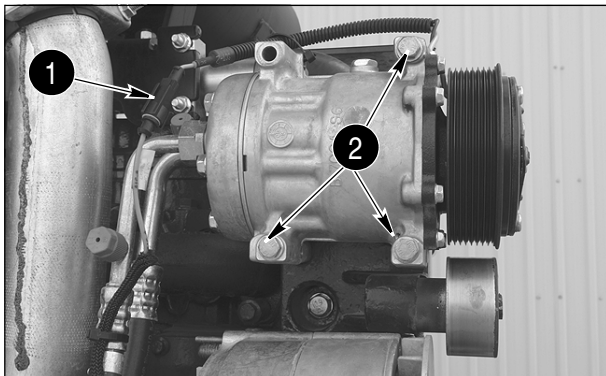

BD06F117

If loader is equipped with air conditioning, mount the compressor using the three mounting bolts (2), connect the engine wiring harness connectors to air compressor clutch connector (1). Remove and discard tags.

**STEP 62**

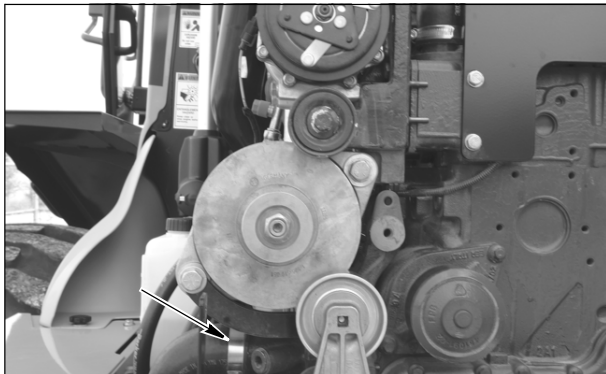

BD06F116

Install lower cooler hose to the engine and tighten the clamps to a torque of 10.1 to 11.3 Nm (90 to 100 lb-inch).

**STEP 63**

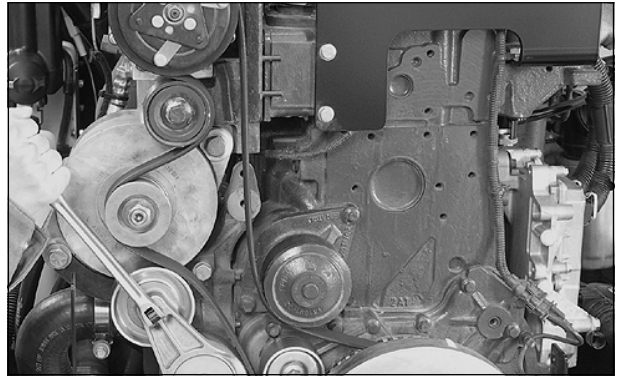

BD06F115

Install the drive belt.

**STEP 64**

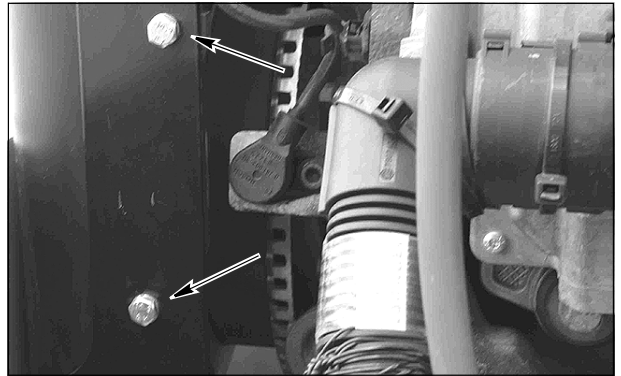

BD06F113

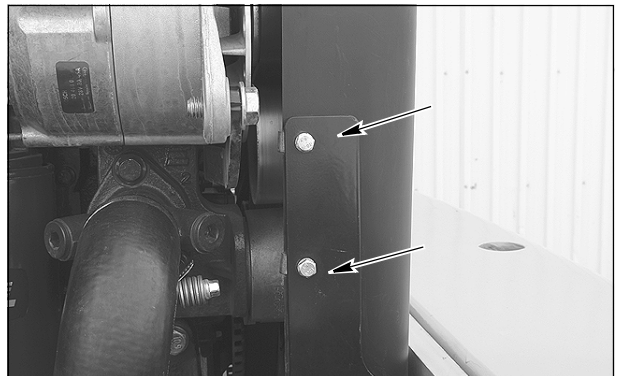

BD06F114

Install the cover mounting brackets to the machine frame. Install the belt cover, install the four mounting bolts for the belt cover.

2000-14

### STEP 65



BD06F112

Place the muffer and air cleaner on the bracket. Install mounting bolts in air cleaner and tighten, install the mounting bolts in the muffer and leave loose at this time.

### STEP 66

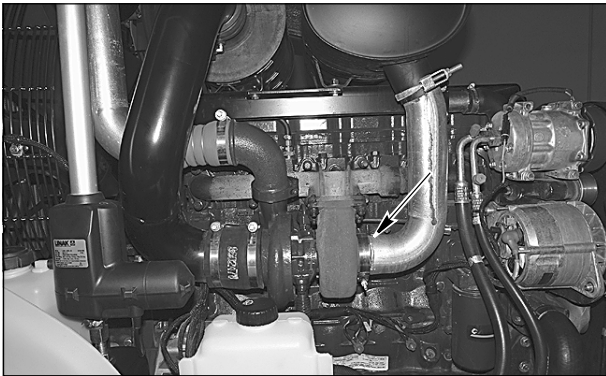

BD06F110

Install and tighten the exhaust clamp on the turbocharger, tighten the muffer mounting bolts.

### STEP 67

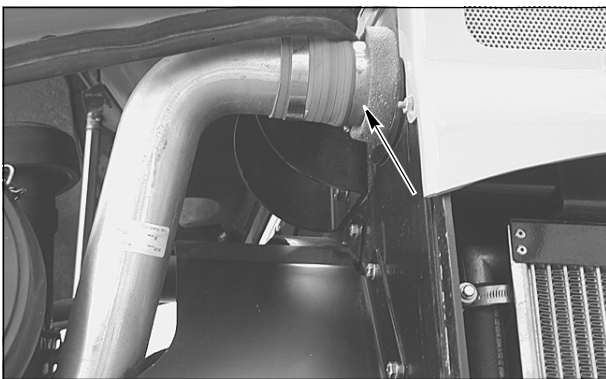

BD03A118

Place the after cooler outlet hose on the machine. Tighten the clamp on the after cooler.

### STEP 68

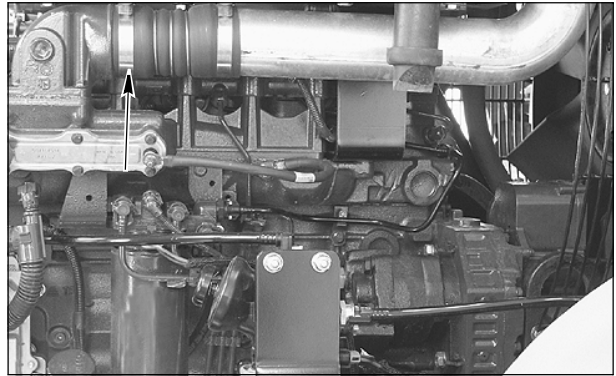

BD06F111

Tighten the clamp on the intake manifold for the after cooler output hose.

### STEP 69



BD03A115

Place the after cooler inlet hose on the machine. Tighten the clamp on the after cooler.

### STEP 70



BD06F110

Tighten the clamp on the turbocharger for the after cooler inlet hose.

**STEP 71**

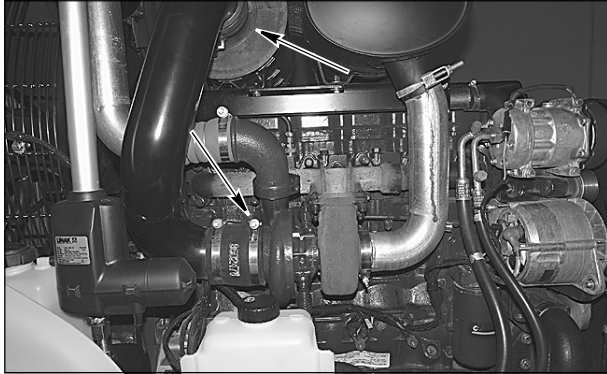

BD06F110

Install the intake hose and tighten the clamps on turbocharger and air cleaner.

**STEP 72**

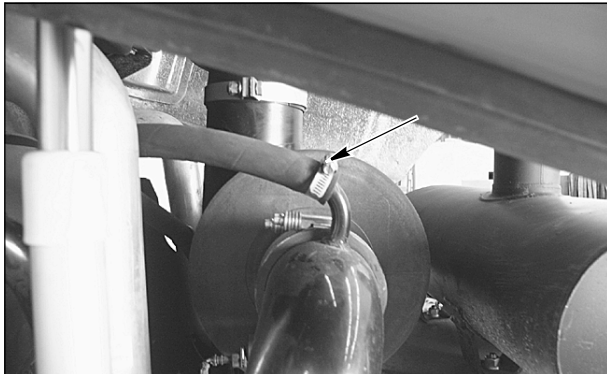

BD03A225

Install the crankcase ventilation hose and tighten the clamp on air cleaner intake hose.

**STEP 73**

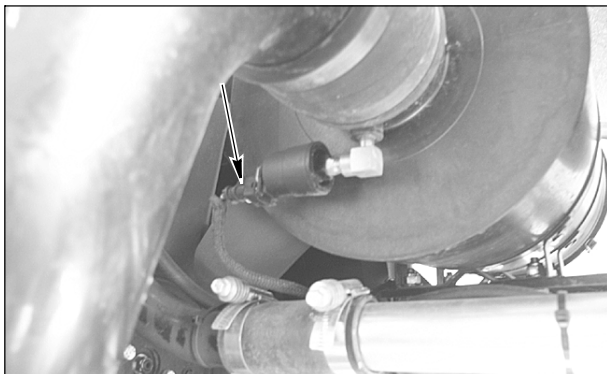

BD03A224

Connect engine wiring harness connector to air filter restriction switch. Remove and discard tag.

**STEP 74**



BD03A232

Carefully raise and place hood over loader.

**NOTE:** Refer to step 7 and 8 of removal for lifting procedure.

**STEP 75**

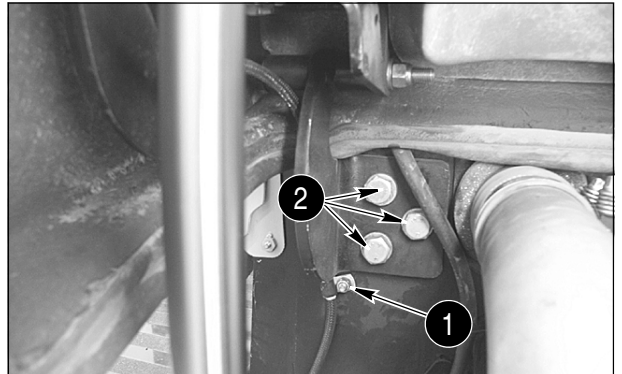

BD03A227

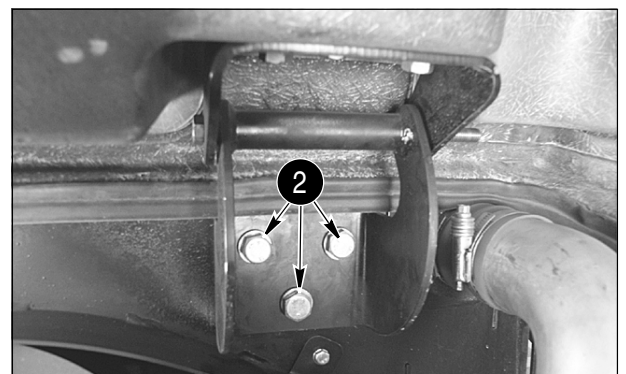

BD03A226

Have another person balance the hood, install the hood hinge mounting bolts (2) to the cooler frame. Install mount bolt (1) and backup alarm wiring harness clamp to cooler housing.

**STEP 76**

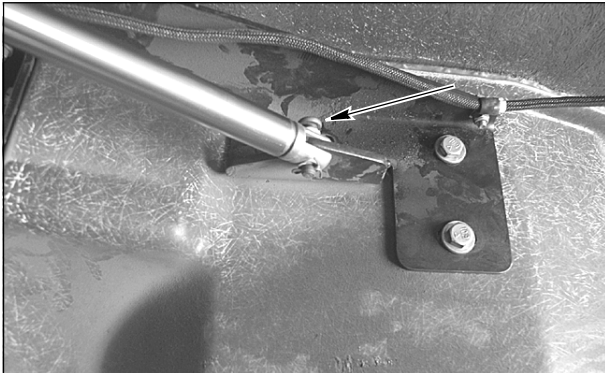

BD03A228

Install the pin from the top of the lifting motor, lower and remove lifting equipment.

**STEP 77**

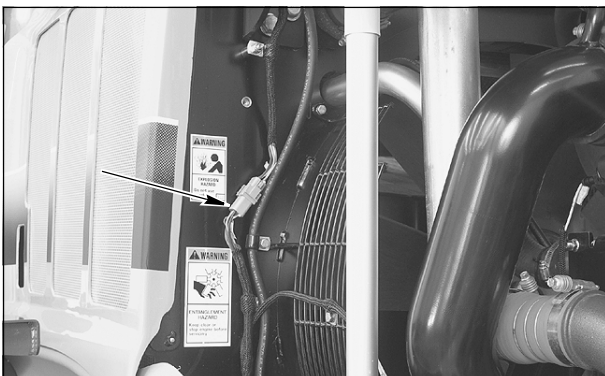

BD06F109

Connect hood wiring harness connector to rear chassis wiring harness connector. Remove and discard tag.

**STEP 78**

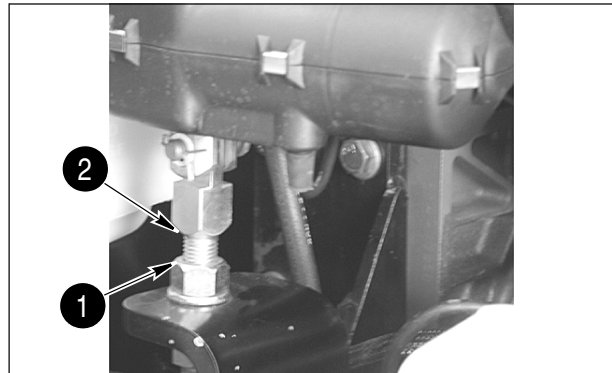

BD03A221

**NOTE:** If hood strut is not adjusted properly the hood will be damaged.

When a hood is removed and replaced an initial adjustment on the strut is necessary. Adjust between the top of the lift motor adjusting jam nut (1) to the top of the threads (2) to 20 mm (X). With the motor down to its lowest point take a measurement between the left hand side hood bumper and the counter weight, record this measurement (Y). Use the following table to adjust the strut (X).

Hood Adjustment Table							
Y (MM)	X (MM)	Y (MM)	X (MM)	Y (MM)	X (MM)	Y (MM)	X (MM)
1	19	21	14	41	9	61	5
2	19	22	14	42	9	62	5
3	18	23	14	43	9	63	4
4	18	24	13	44	9	64	4
5	18	25	13	45	9	65	4
6	18	26	13	46	8	66	4
7	17	27	13	47	8	67	3
8	17	28	12	48	8	68	3
9	17	29	12	49	8	69	3
10	17	30	12	50	7	70	3
11	16	31	12	51	7	71	2
12	16	32	12	52	7	72	2
13	16	33	11	53	7	73	2
14	16	34	11	54	6	74	2
15	16	35	11	55	6	75	2
16	15	36	11	56	6	76	1
17	15	37	10	57	6	77	1
18	15	38	10	58	6	78	1
19	15	39	10	59	5	79	1
20	14	40	10	60	5	80	0

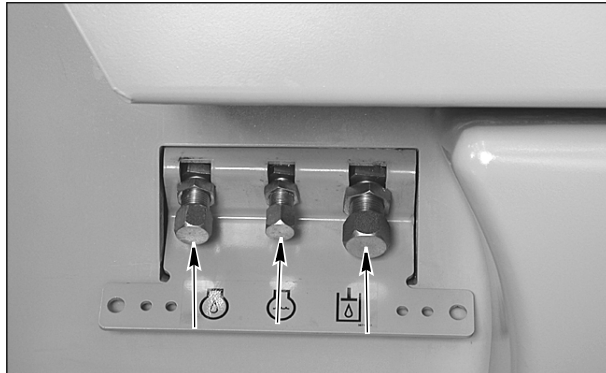
**STEP 79**

BD02N160

Check and make sure that drain caps are tight.

**STEP 80**

Install a new oil filter on engine. Fill engine with 13.25 liters (14 U.S. quarts) of Case AKCELA Engine Oil (SAE 15W-40).

**STEP 81**

If hydraulic reservoir was drained, fill reservoir with 90.8 liters (24.0 U.S. gallons) of Case AKCELA Hy-Tran Ultra® fluid.

**STEP 82**

Fill engine coolant system with a solution of 50% Ethylene Glycol and 50% water. Cooling system capacity is 28.4 liters (30.0 U.S. quarts). Install the radiator cap. Fill the coolant reservoir up to the FULL mark on the reservoir.

**STEP 83**

Connect the batteries, install battery covers, put master disconnect switch in ON position.

**STEP 84**

Start engine and run the engine at low idle. Run the engine at operating temperature for approximately five minutes to completely mix the Ethylene Glycol and water. When the coolant is at operating temperature, stop the engine. When engine has cooled, check the coolant level at the reservoir.

**WARNING:** *Hot coolant can spray out if radiator cap is removed. To remove radiator cap: Let system cool, turn to first notch, then wait until all pressure is released. Scalding can result from fast removal of radiator cap.*

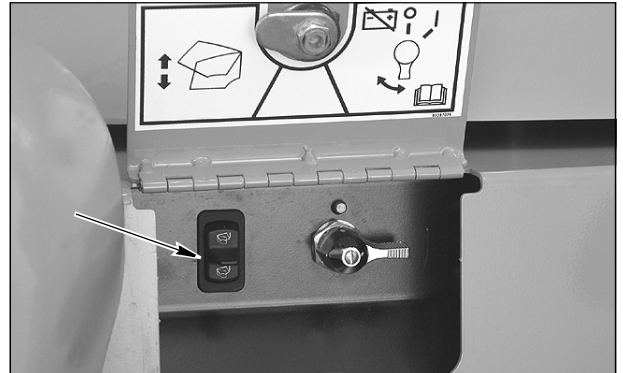
**STEP 85**

BD06F108

Lower the hood with the hood lift motor.

**STEP 86**

Put articulation lock in OPERATING position.

## RADIATOR

### Removal

#### STEP 1

Park loader on level surface and lower bucket to ground. Apply parking brake and shut down engine.

#### STEP 2

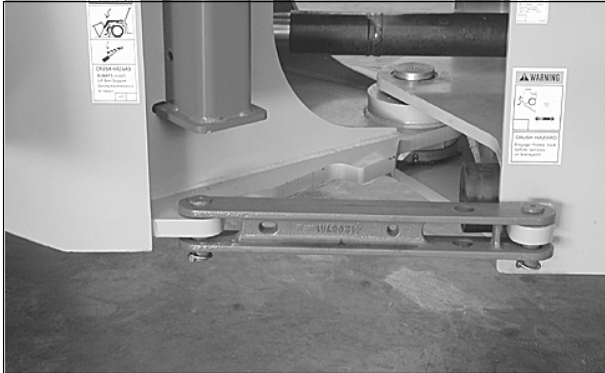

BD03A040

Put articulation lock in LOCKED position.

#### STEP 3

Put master disconnect switch in OFF position.

#### STEP 4

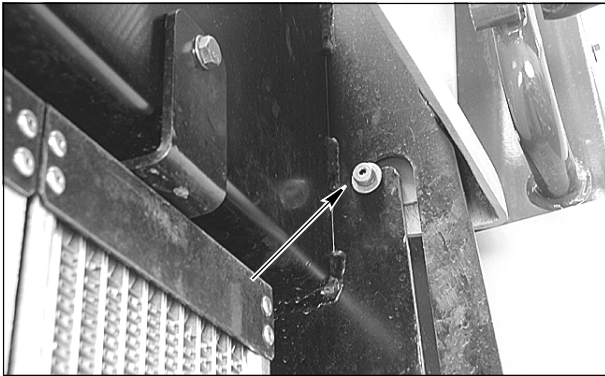

BD03A120

Have another person raise and hold the side panel up into the raised position. Remove the two mounting screws for the side panel, remove the panel.

**NOTE:** Photo is of the oil cooler side of the machine, the procedure is the same.

#### STEP 5



BD06F128

Remove bolt and washer securing LH fender. Remove LH fender.

#### STEP 6

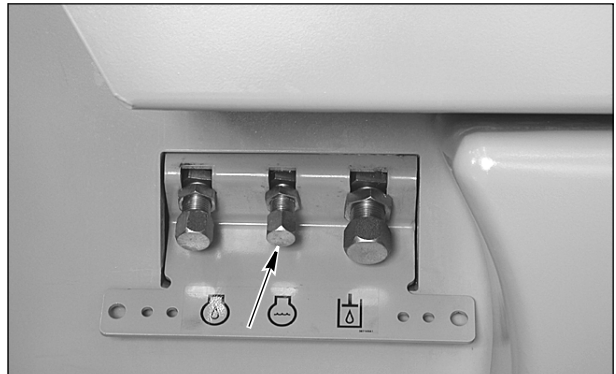

BD02N160

Put a 28.4 liter (30.0 U.S. quart) container below radiator drain. Remove radiator cap then remove cap and drain coolant into container. Install cap after coolant has drained. Install radiator cap.

#### STEP 7

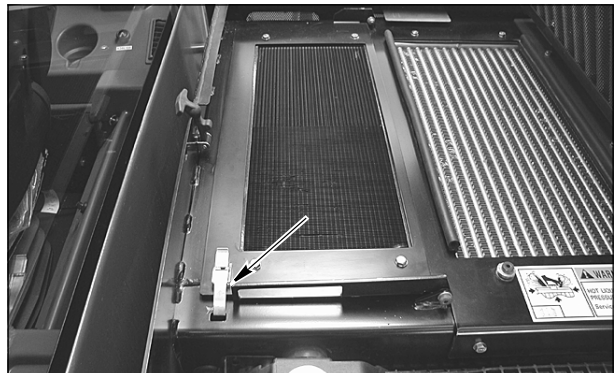

BD03A109

Release catch and tilt air conditioning condenser core up to gain access to upper radiator hose.

**STEP 8**

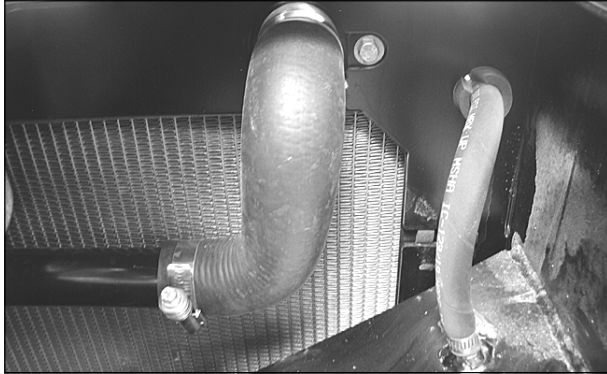

BD03A108

Loosen the upper radiator hose clamps, remove the hose.

**STEP 9**



BD06F129

Loose and remove the lower radiator hose from the radiator.

**STEP 10**



BD03A113

Disconnect overflow hose from radiator. Disconnect connector from coolant level sender.

**STEP 11**

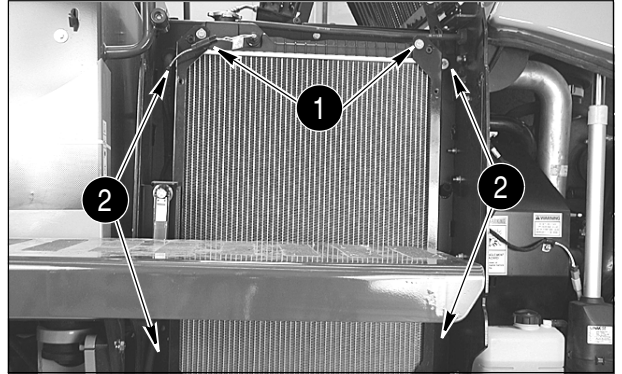

BD03A106

Remove screws and install lifting eyes (1). Attach suitable lifting equipment to lifting eyes. Remove four mounting bolts (2), remove radiator from machine.

2000-20

## Installation

### STEP 12

Move radiator into position above cooling frame. Carefully lower radiator while guiding it into position in cooling frame.

### STEP 13

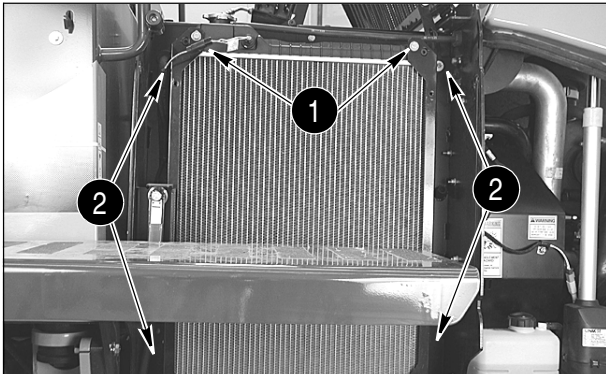

BD03A106

Install four lock washers and bolts (2) to secure radiator to cooling frame. Disconnect lifting equipment from lifting eyes. Remove lifting eyes and install screws (1).

### STEP 14



BD03A113

Connect connector to coolant level sender, connect overflow hose to radiator.

### STEP 15



BD06F129

At bottom of radiator, install bottom radiator hose. Position and tighten two hose clamps to a torque of 10.1 to 11.3 Nm (90 to 100 lb-inch).

### STEP 16

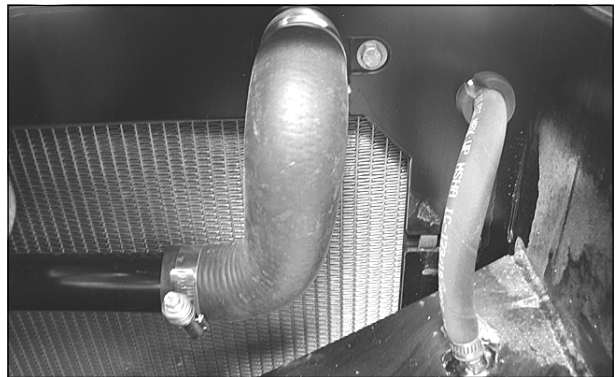

BD03A108

At top of cooling system frame, install hose. Position hose clamps and tighten to a torque of 10.1 to 11.3 Nm (90 to 100 lb-inch).

### STEP 17

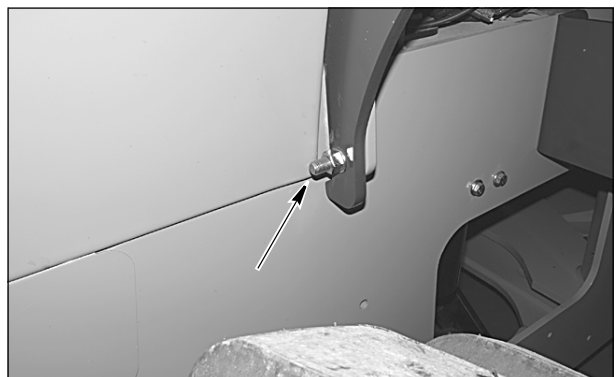

BD06F130

When installing fender make sure it is behind the fender mounting bolt.



**Suggest:**

**If the above button click is invalid.**

**Please download this document**

**first, and then click the above link**

**to download the complete manual.**

**Thank you so much for reading**

**STEP 18**

BD06F131

Align the whole in the fender on the bolt.

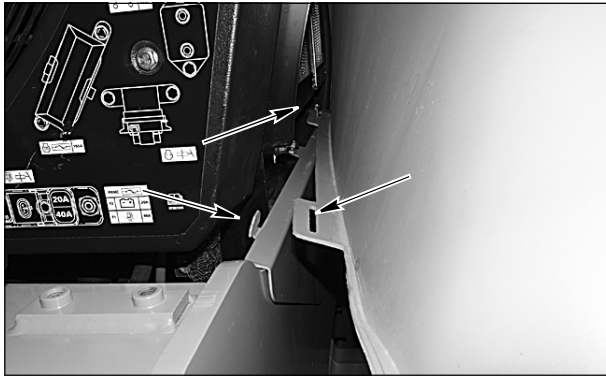
**STEP 19**

BD06F132

Align the slots in the fender with the tabs on the body of the machine.

**STEP 20**

DSC00105.TIF

Push the fender towards the front of the machine and secure it using washer and bolt.

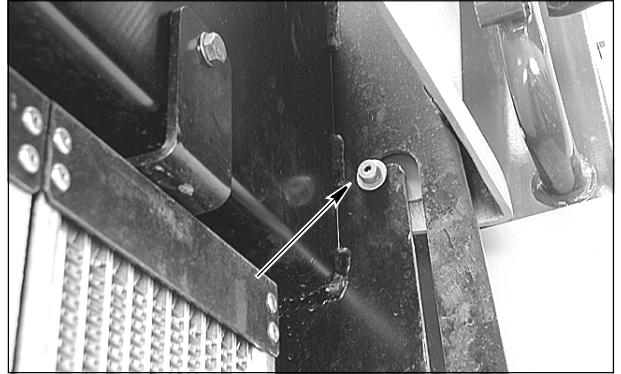
**STEP 21**

BD03A120

Have another person raise and hold the side panel up into position. Apply Loctite 242 to the threads, install the two mounting screws for the side panel and torque to  $6.5 \pm 3.0$  Nm ( $57.5 \pm 26.5$  pound-inches).

**NOTE:** Photo is of the oil cooler side of the machine, the procedure is the same.

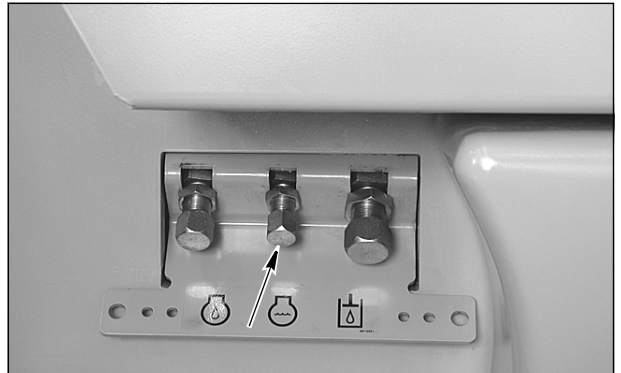
**STEP 22**

BD02N160

Check that coolant drain cap is tight.

**STEP 23**

Fill engine coolant system with a solution of 50% Ethylene Glycol and 50% water. Cooling system capacity is 28.4 liters (30.0 U.S. quarts). Install the radiator cap. Fill the coolant reservoir up to the FULL mark on the reservoir.

**<https://www.ebooklibonline.com>**

Hello dear friend!

Thank you very much for reading.

Enter the link into your browser.

The full manual is available for immediate download.

**<https://www.ebooklibonline.com>**