

621E Wheel Loader Repair Manual 87723028 A - EU

Table of Contents

Description	Section No.
General Tab 1	
Section Index - General	
Standard Torque Specifications	1001
Fluids and Lubricants	1002
Metric Conversion Chart	1003
Engines Tab 2	
Section Index - Engines	
Engine and Radiator Removal and Installation	2000
Stall Tests	2002
After Cooler	2003
For Engine Repair, See the Engine Service Manual 87519803	
Fuel System Tab 3	
Section Index - Fuel System	
For Fuel System Repair, See the Engine Service Manual 87519803	
Electrical Tab 4	
Section Index - Electrical	
Removal and Installation of Starter and Alternator	4001
Electrical Specifications and Troubleshooting	4002
Batteries	4003
Instrument Cluster	4005
Steering Tab 5	
Section Index - Steering	
Removal and Installation of Steering Components	5001
Steering Specifications, Pressure Checks, and Troubleshooting	5002
Steering Cylinders	5005
Center Pivot	5006
Auxiliary Steering Motor and Pump	5008

621E Wheel Loader Repair Manual 87723028 A - EU

Table of Contents

Description	Section No.
Power Train	
	Tab 6
Section Index - Power Train	
Removal and Installation of Power Train Components	6001
Transmission Specifications, Pressure Checks, and Troubleshooting	6002
Transmission	6003
Front Axle	6004
Rear Axle	6004
Drive Shafts, Center Bearing, and Universal Joints	6005
Wheels and Tires	6006
Transmission Control Valve	6007
Brakes	
	Tab 7
Section Index - Brakes	
Removal and Installation of Brake Components	7001
Hydraulic Brake Troubleshooting	7002
Brake Pump	7003
Brake Accumulators	7004
Parking Brake	7008
Hydraulics	
	Tab 8
Section Index - Hydraulics	
How to Read Hydraulic Schematics	8000
Removal and Installation of Hydraulic Components	8001
Hydraulic Specifications, Troubleshooting, and Pressure Checks	8002
Cleaning the Hydraulic System	8003
Hydraulic Pump	8004
Loader Control Valve	8005
Cylinders	8006
Coupler Solenoid Locking Valve	8007
Ride Control Accumulator	8013
Ride Control Valve	8014

621E Wheel Loader Repair Manual 87723028 A - EU

Table of Contents

Description	Section No.
Mounted Equipment	Tab 9
Section Index - Mounted Equipment	
Air Conditioning Troubleshooting and System Checks For Systems with HFC-134a Refrigerant	9002
Air Conditioner System Service	9003
Removal And Installation Of Air Conditioning And Heater Components	9004
Loader	9006
Roll Over Protective Structure (ROPS), Cab Structural Frame (CSF)	9007
Cab Glass Installation	9010
Electrical Schematic Foldouts and Hydraulic Schematic Foldout	In Rear Pocket

<https://www.ebooklibonline.com>

Hello dear friend!

Thank you very much for reading.

Enter the link into your browser.

The full manual is available for immediate download.

<https://www.ebooklibonline.com>

SECTION INDEX

GENERAL

Section Title	Section Number
Standard Torque Specifications	1001
Fluids and Lubricants	1002
Metric Conversion Chart	1003

TORQUE SPECIFICATIONS - DECIMAL HARDWARE

Use the torques in this chart when special torques are not given. These torques apply to fasteners with both UNC and UNF threads as received from suppliers dry, or when lubricated with engine oil. Not applicable if special graphities, Molydisulfide greases, or other extreme pressure lubricants are used.

Grade 5 Bolts, Nuts, and Studs		
		
Size	Pound-Inches	Newton metres
1/4 inch	108 to 132	12 to 15
5/16 inch	204 to 252	23 to 28
3/8 inch	420 to 504	48 to 57
Size	Pound-Feet	Newton metres
7/16 inch	54 to 64	73 to 87
1/2 inch	80 to 96	109 to 130
9/16 inch	110 to 132	149 to 179
5/8 inch	150 to 180	203 to 244
3/4 inch	270 to 324	366 to 439
7/8 inch	400 to 480	542 to 651
1.0 inch	580 to 696	787 to 944
1-1/8 inch	800 to 880	1085 to 1193
1-1/4 inch	1120 to 1240	1519 to 1681
1-3/8 inch	1460 to 1680	1980 to 2278
1-1/2 inch	1940 to 2200	2631 to 2983

Grade 8 Bolts, Nuts, and Studs		
		
Size	Pound-Inches	Newton metres
1/4 inch	144 to 180	16 to 20
5/16 inch	288 to 348	33 to 39
3/8 inch	540 to 648	61 to 73
Size	Pound-Feet	Newton metres
7/16 inch	70 to 84	95 to 114
1/2 inch	110 to 132	149 to 179
9/16 inch	160 to 192	217 to 260
5/8 inch	220 to 264	298 to 358
3/4 inch	380 to 456	515 to 618
7/8 inch	600 to 720	814 to 976
1.0 inch	900 to 1080	1220 to 1465
1-1/8 inch	1280 to 1440	1736 to 1953
1-1/4 inch	1820 to 2000	2468 to 2712
1-3/8 inch	2380 to 2720	3227 to 3688
1-1/2 inch	3160 to 3560	4285 to 4827

NOTE: Use thick nuts with Grade 8 bolts.

TORQUE SPECIFICATIONS - METRIC HARDWARE

Use the following torques when specifications are not given.

These values apply to fasteners with coarse threads as received from supplier, plated or unplated, or when lubricated with engine oil. These values do not apply if graphite or Molydisulfide grease or oil is used.

Grade 8.8 Bolts, Nuts, and Studs		
		
Size	Pound-Inches	Newton metres
M4	24 to 36	3 to 4
M5	60 to 72	7 to 8
M6	96 to 108	11 to 12
M8	228 to 276	26 to 31
M10	456 to 540	52 to 61
Size	Pound-Feet	Newton metres
M12	66 to 79	90 to 107
M14	106 to 127	144 to 172
M16	160 to 200	217 to 271
M20	320 to 380	434 to 515
M24	500 to 600	675 to 815
M30	920 to 1100	1250 to 1500
M36	1600 to 1950	2175 to 2600

Grade 10.9 Bolts, Nuts, and Studs		
		
Size	Pound-Inches	Newton metres
M4	36 to 48	4 to 5
M5	84 to 96	9 to 11
M6	132 to 156	15 to 18
M8	324 to 384	37 to 43
Size	Pound-Feet	Newton metres
M10	54 to 64	73 to 87
M12	93 to 112	125 to 150
M14	149 to 179	200 to 245
M16	230 to 280	310 to 380
M20	450 to 540	610 to 730
M24	780 to 940	1050 to 1275
M30	1470 to 1770	2000 to 2400
M36	2580 to 3090	3500 to 4200

Grade 12.9 Bolts, Nuts, and Studs

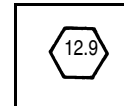

Usually the torque values specified for grade 10.9 fasteners can be used satisfactorily on grade 12.9 fasteners.

MAINTENANCE SCHEDULE

Model 621E

SERVICE INTERVAL	ITEM NUMBER	SERVICE POINTS	Initial Service	FREQUENCY IN HOURS							
				CHECK	CLEAN	CHANGE	DRAIN	LUBRICATE	REPLACE	ADJUST	
Variable Periodic (*)	29	Air cleaner		*	*						
	18	Bleed Fuel Filter of Condensation					*				
	19	Hydraulic Filter		*							
	22	Alternator, AC, Drive Belt		*							
	13	Radiator Coolant Level		*							
	XX	Fire extinguisher		*							
	14	Tires		*							
Every 10 Hours	1	Check Engine Oil Level		10							
Every 50 Hours	2	Check Engine Coolant Level		50							
	3	Check Transmission Oil Level		50							
	4	Check Hydraulic Oil Level		50							
	5 & 6	Grease Bucket Mounting Fittings						50			
Every 100 Hours	7	Grease Front Drive Shaft Support Bearing						100			
	8 & 9	Lubricate The Steering Cylinder Pivots - Rod And Closed End (4 Fittings)						100			
	10	Lubricate Loader Lift & Cylinder Pivots (10) Z-bar						100			
	11	Lubricate Loader Lift & Cylinder Pivots (18) XT						100			
Every 250 Hours	12	Check Cab Air Filter		250							
	13	Check Tire Pressure & Wheel Torque	100	250							
	14	Check Drive Belt		250							
Every 500 Hours	15	Check Battery Electrolyte Level		500							
	16	Check Axle Oil Level		500							
	17	Drain Fuel Tank Condensation & Water Separator					500				
	18	Change Engine Oil and Filter	100			500					
	18	Change Crankcase Filter				500					
	19 & 27	Replace Fuel Filter	100						500		
	XX	ROPS/CSF and seat belt torques		500							
Every 1000 Hours	20	Change Front & Rear Axle Oil	100			1000					
	21	Replace Hydraulic Oil filter	100						1000		
	22	Replace Cab Air Filter							1000		
	23	Replace Drive Belt							1000		
	24	Change Transmission Oil and Filter	100			1000					
	25	Grease Articulation Fittings						1000			
	26	Check Injector Calibration		1000							
	27	Fuel Pre-Filter				1000					
	XX	Drive Shaft Slip Joint						1000			
	XX	Check Valve Adjustment (Engine Manual)		1000							
Every 2000 Hours	XX	Trans Clutch Calibration (See Section 6002)	250	1000							
	28	Change Hydraulic Oil				2000					
	29	Change Coolant				2000					
Every 4000 Hours	30	Replace Engine Air Cleaner							2000		
	XX	Valve Clearance (Engine Manual)									4000

MAINTENANCE POINTS Model 621E

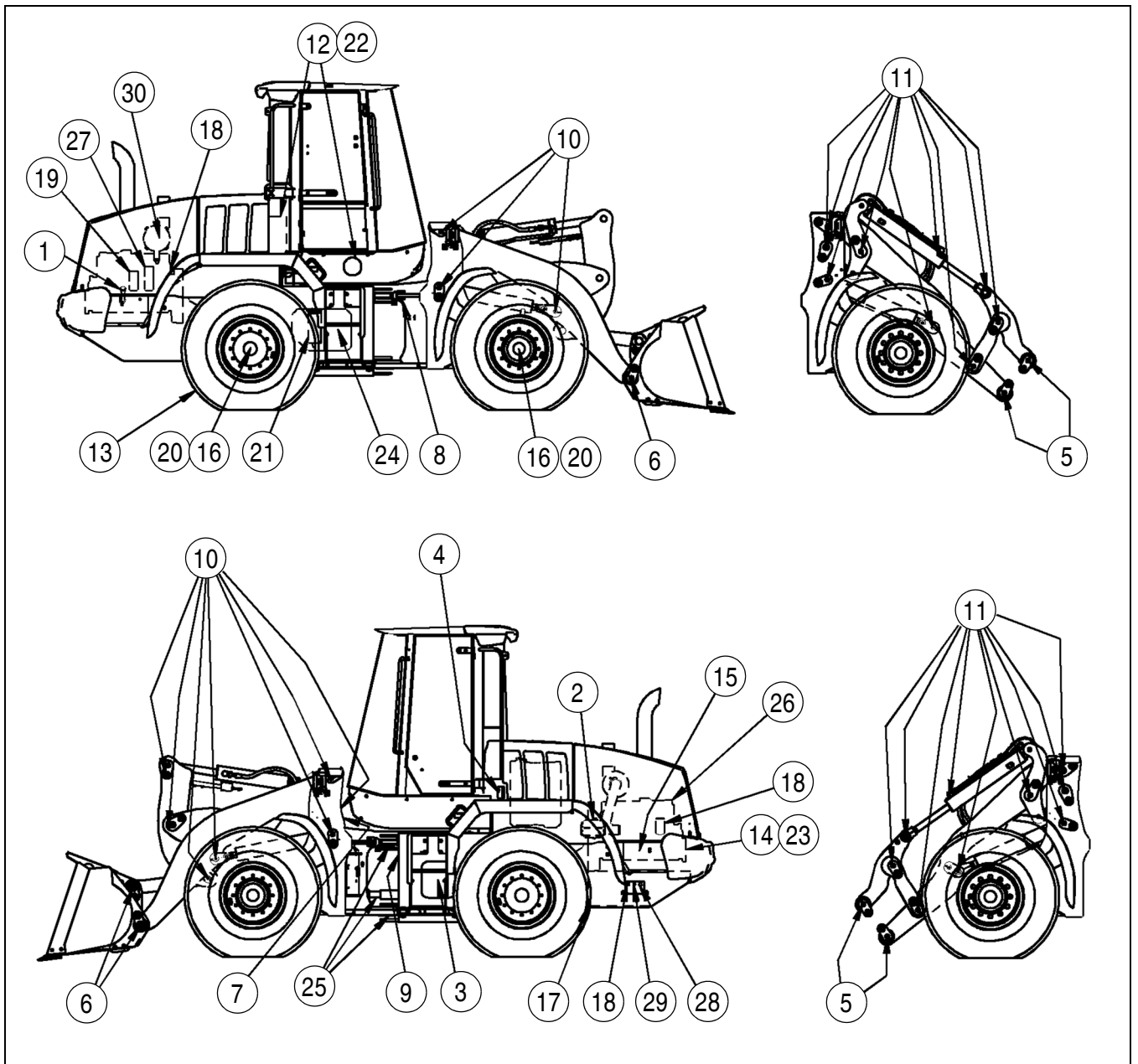

BS07D423

See your Operators manual for maintenance of safety related items and for detailed information of the service items on this chart. Operators and service manuals are available for this machine from your dealer.

If you operate the machine in severe conditions, lubricate and service the machine more frequently.

Section 2000

ENGINE AND RADIATOR REMOVAL AND INSTALLATION

ENGINE

Removal

STEP 1

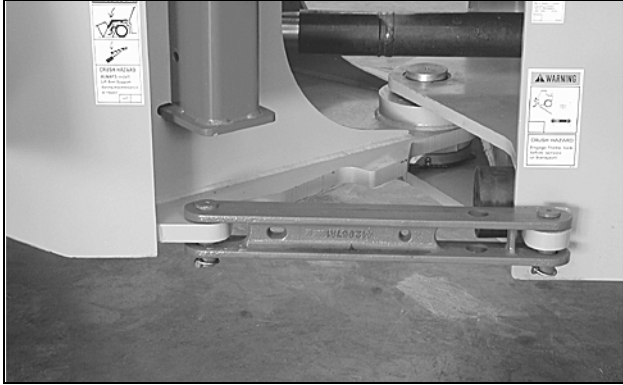

BD03A040

Park machine on a level surface and lower bucket to ground. Put articulation lock in LOCKED position.

STEP 2

Stop engine. Actuate brake pedal several times to discharge brake accumulators. Put key switch in ON position and move loader control lever back and forth at least 30 times to release any pressure from hydraulic circuit. Put key switch in OFF position.

STEP 3

Slowly loosen the filler cap for hydraulic reservoir to release air pressure in hydraulic reservoir.

STEP 4

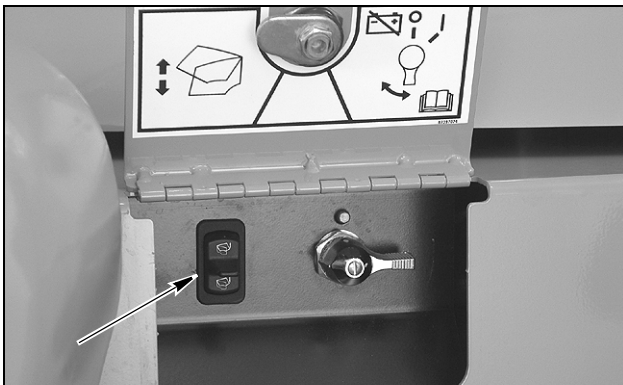

BD06F108

The master and hood raise switch are located in the right batter box. Raise the hood with the hood lift motor. Put master disconnect switch in OFF position. Remove both battery covers and disconnect batteries from the machine.

STEP 5



BD02N160

Put a 37 liter (10 gallon) container below radiator drain. Remove radiator cap. Remove cap and drain coolant into container. Install cap after coolant has drained. Install radiator cap.

STEP 6

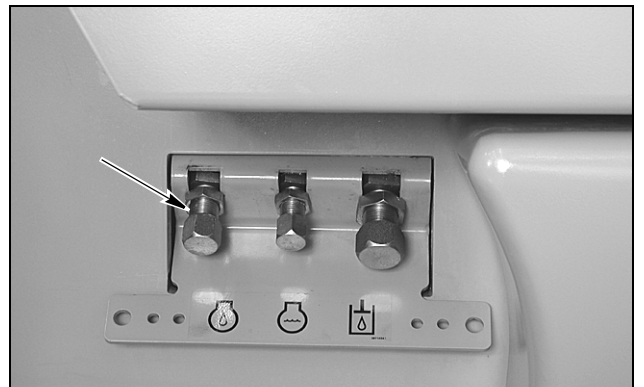

BD02N160

Put a 14.2 liter (15 U.S. quarts) container below engine oil drain. Remove cap and drain oil into container. Install cap after oil has drained.

NOTE: After draining oil disconnect drain hose from frame for removal with engine.

STEP 7

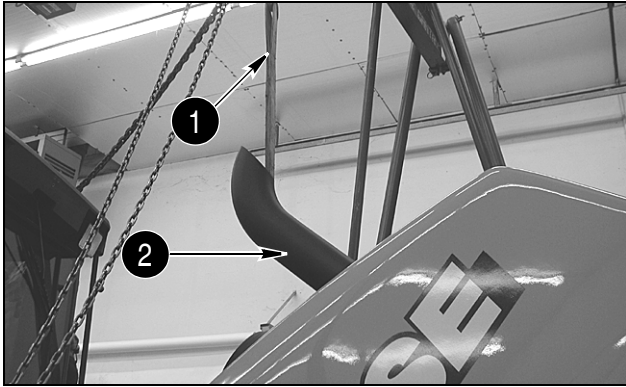

BD03A231

Double up a nylon lifting strap (1) and slide through the exhaust stack (2) on the hood.

STEP 8

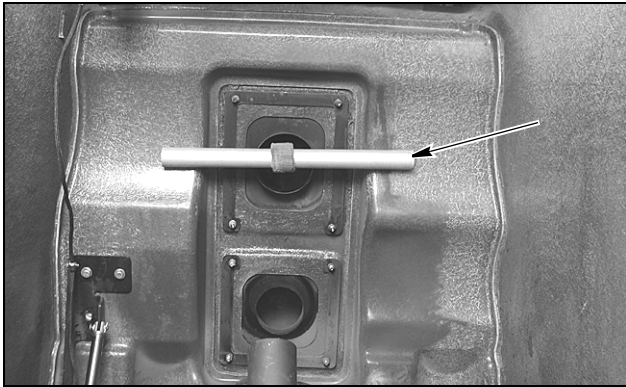

BD03A230

Place a solid steel bar through the strap, raise the hood and release tension on the lifting motor.

STEP 9

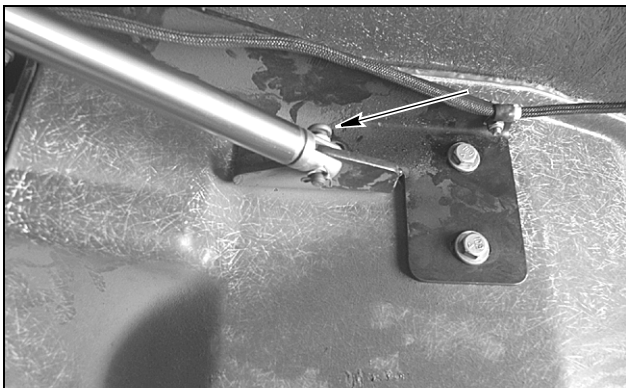

BD03A228

Remove the pin from the top of the lifting motor.

STEP 10



BD06F109

Tag and disconnect hood wiring harness connector from rear chassis wiring harness connector.

STEP 11

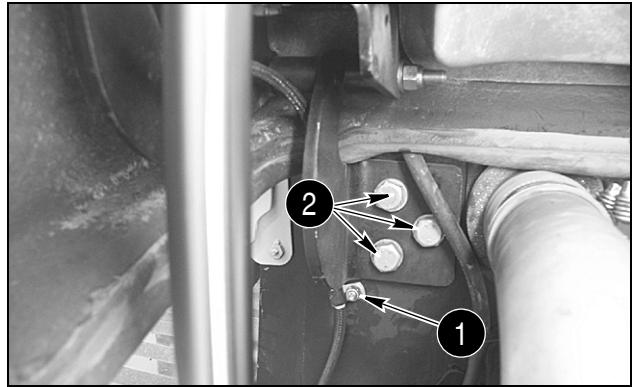

BD03A227

Remove mount bolt (1) and backup alarm wiring harness clamp from cooler housing. Have another person balance the hood and remove the hood hinge mounting bolts (2) from the cooler frame.

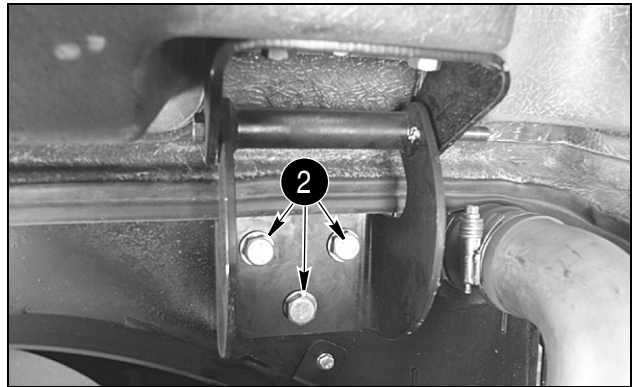

BD03A226

Remove mount bolt (1) and backup alarm wiring harness clamp from cooler housing. Have another person balance the hood and remove the hood hinge mounting bolts (2) from the cooler frame.

STEP 12



BD03A232

Carefully raise and remove hood from loader. Lower hood onto suitable platform and disconnect lifting equipment.

STEP 13

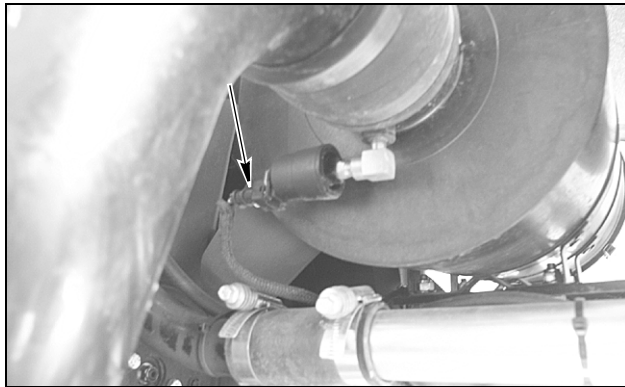

BD03A224

Tag and disconnect engine wiring harness connector from air filter restriction switch.

STEP 14



BD03A225

Loosen clamp on air cleaner intake hose and remove the crankcase ventilation hose.

STEP 15

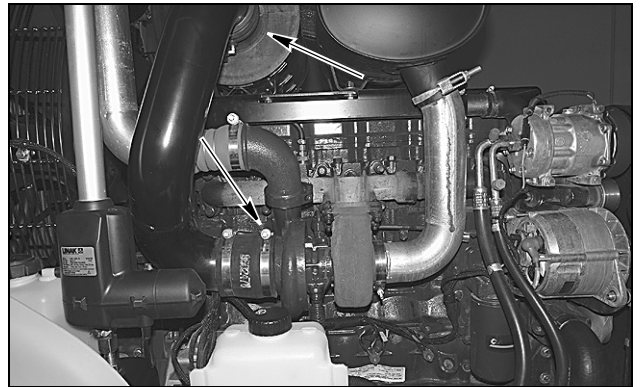

BD06F110

Loosen clamps on turbocharger and air cleaner, remove the intake hose.

STEP 16

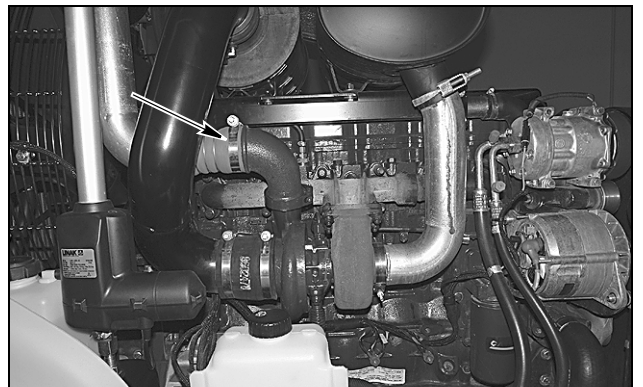

BD06F110

Loosen the clamp on the turbocharger for the after cooler inlet hose.

STEP 17



BD03A115

Loosen the clamp on the after cooler and remove the after cooler inlet hose from the machine.

STEP 18

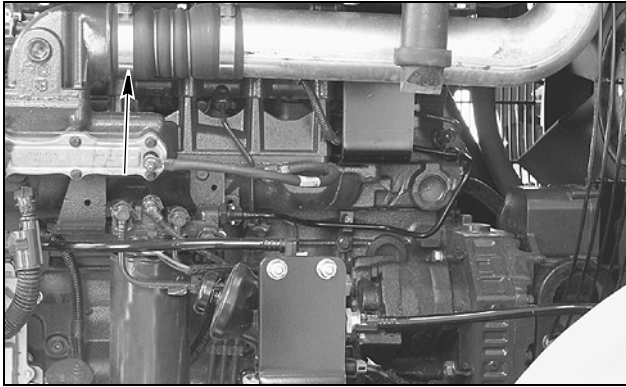

BD06F111

Loosen the clamp on the intake manifold for the after cooler output hose.

STEP 19



BD03A118

Loosen the clamp on the after cooler and remove the after cooler outlet hose from the machine.

STEP 20



BD06F110

Loosen the exhaust clamp from the turbocharger.

STEP 21

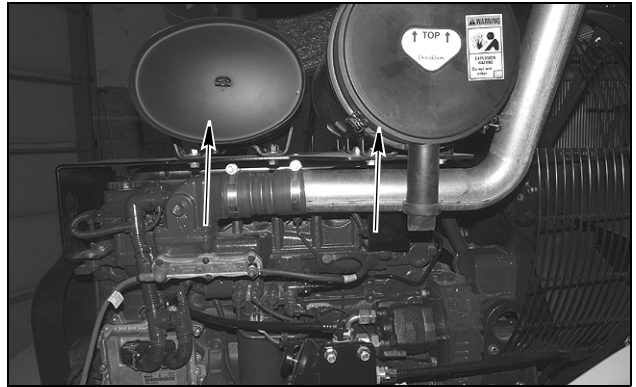

BD06F112

Remove the air cleaner and muffler from the bracket.

STEP 22

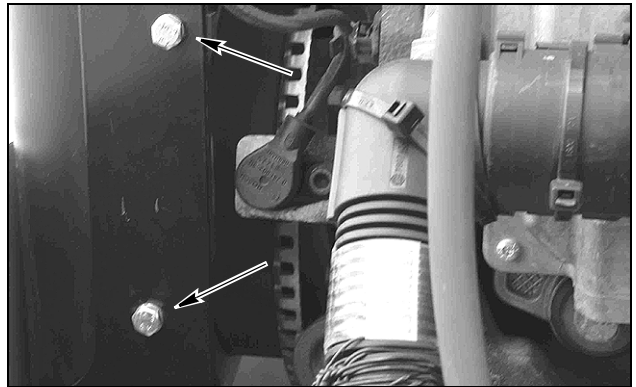

BD06F113

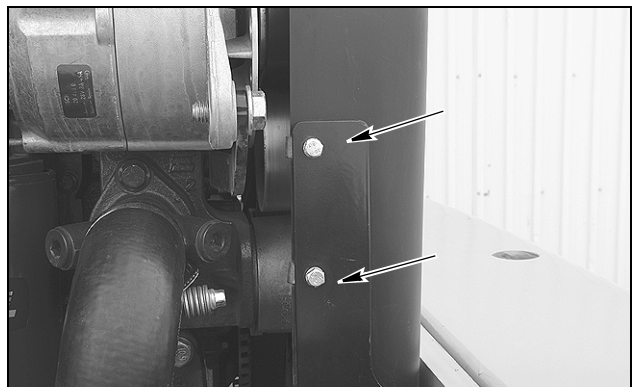

BD06F114

Remove the four mounting bolts from the belt cover, remove the cover.

NOTE: After removing the belt cover remove the cover mounting brackets from the machine frame.

STEP 23

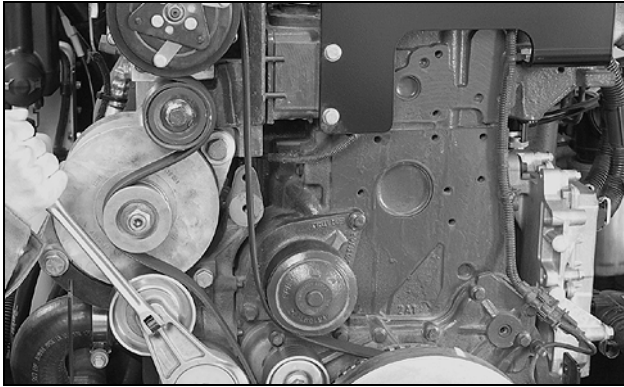

BD06F115

Remove the drive belt from the engine.

STEP 24

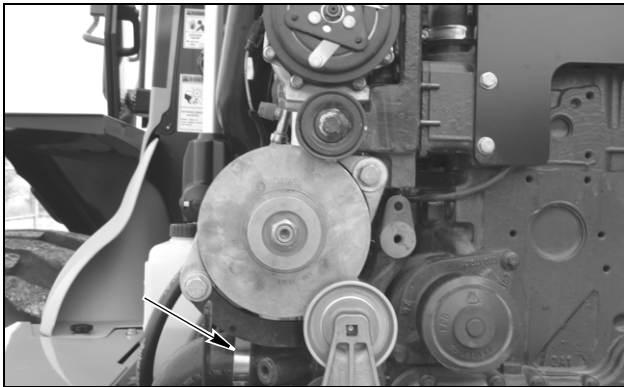

BD06F116

Loosen clamps and remove lower cooler hose from the engine.

STEP 25

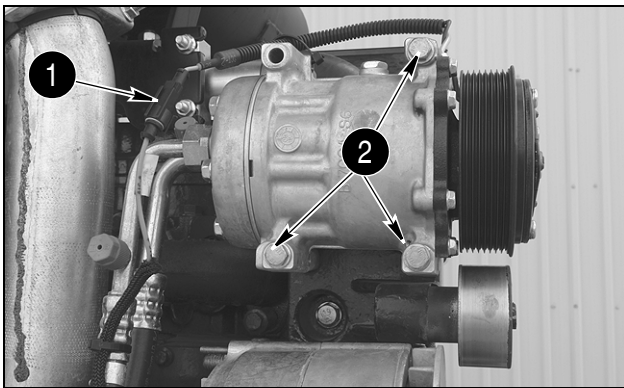

BD06F117

If loader is equipped with air conditioning, identify, tag, and disconnect the engine wiring harness connectors from air compressor clutch connector (1). Remove the three mounting bolts (2) for the compressor and set the compressor on the left battery cover.

STEP 26

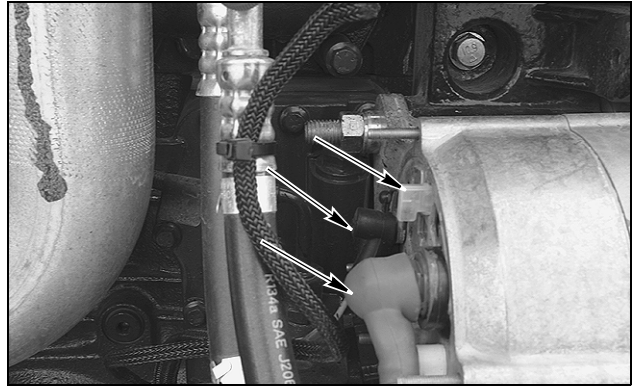

BD06F118

Tag and disconnect the wiring from the alternator.

STEP 27

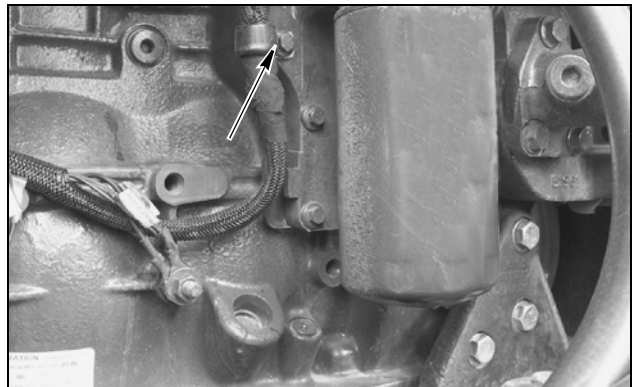

BD06F119

Remove bolt securing wiring harness clamp to engine.

STEP 28

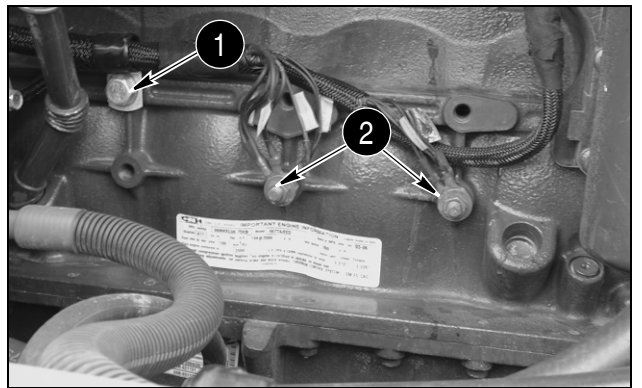

BD06F120

Remove bolt securing wiring harness clamp (1) to the engine. Remove ground wires (2) from the engine.

STEP 29

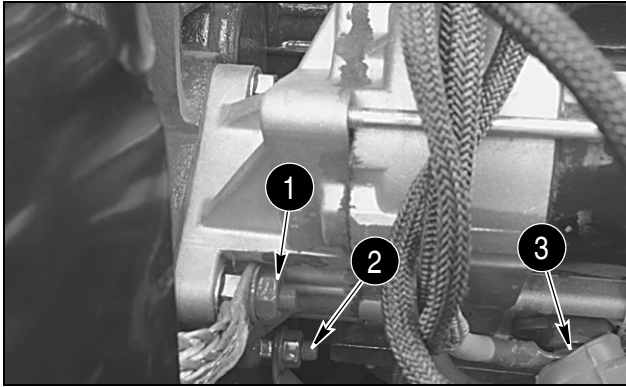

BD06F121

Tag and remove the wires from the starter solenoid (3), remove the ground cable (2), and ground strap (1) from the starter.

NOTE: Move the starter cables away from the engine, move the wiring harness away from the engine.

STEP 30

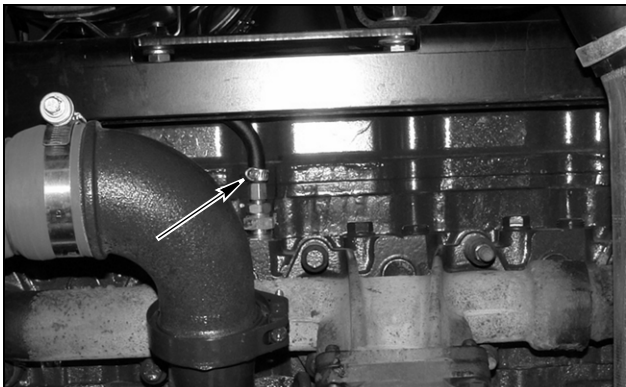

BD06F146

Disconnect the engine coolant vent hose and root to the rear of the engine.

STEP 31

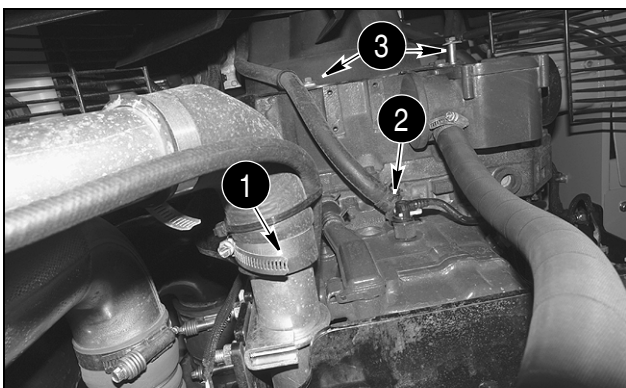

BD06F122

Remove the radiator hose (1) from the rear of the engine, remove the heater hose from the rear of the engine (2), remove the clamp bolts and clamps (3) from the bell housing.

STEP 32

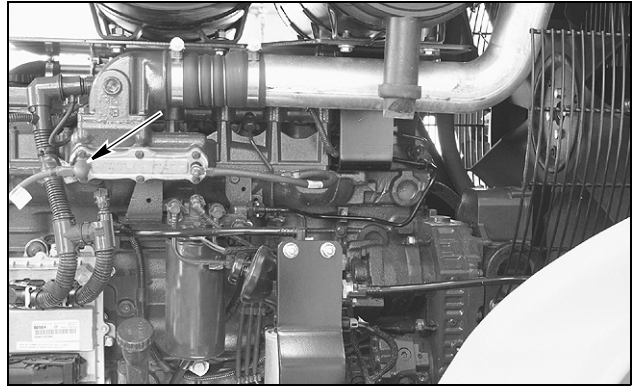

BD06F111

Tag and remove the grid heater cable.

STEP 33

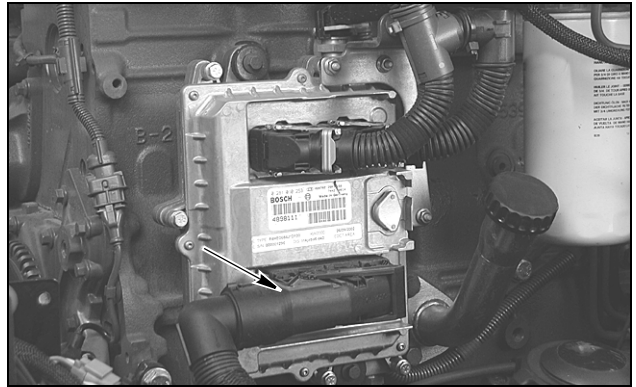

BD03A142

Disconnect the wiring harness from the EDC 7 controller.

NOTE: Lifting up on the lever will release the connector from the controller.

STEP 34

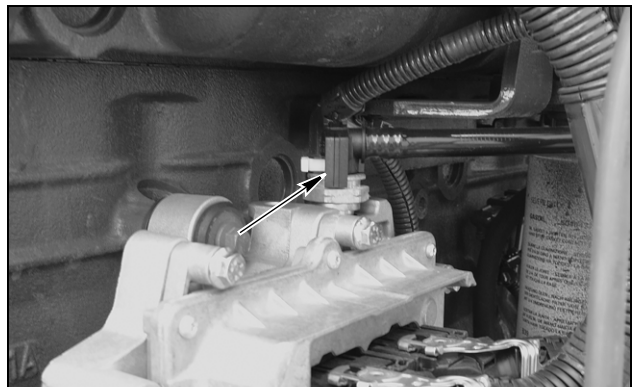

BD06F123

Remove the fuel line from the top of the EDC 7 controller, plug the line and cap the fitting.

STEP 35

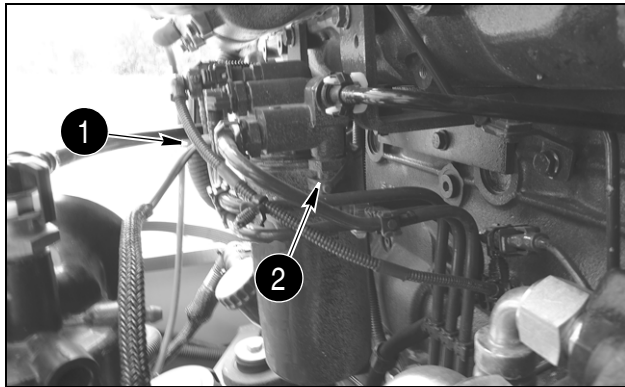

BD06F124

Tag and disconnect the fuel filter heater wires (1), disconnect the fuel line (2) from the fuel filter head, plug the line and cap the fitting.

STEP 36

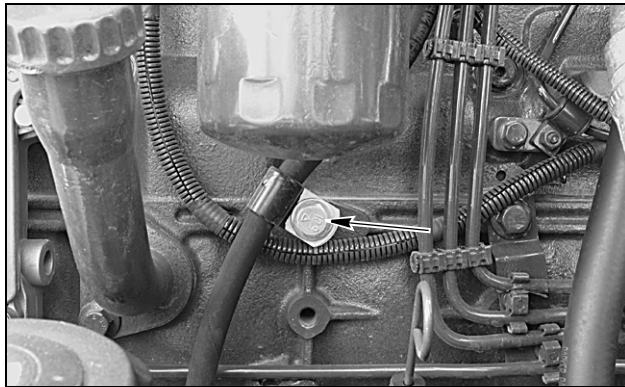

BD06F125

Remove bolt and clamp.

STEP 37

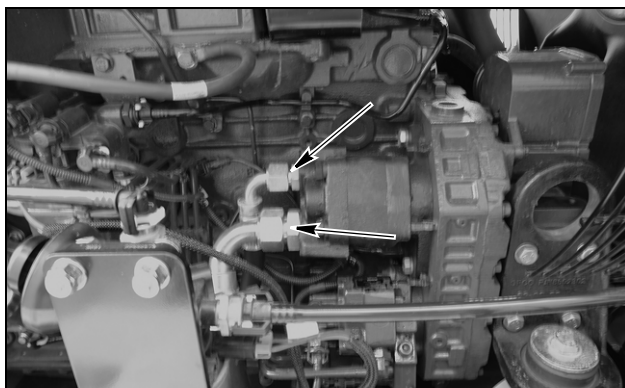

BD06F126

Connect and turn on vacuum pump to hydraulic reservoir. Tag and remove the hydraulic lines from the brake system pump, plug the lines and cap the fittings.

STEP 38



BD06F127

Remove the lower cover for the drive shaft.

STEP 39

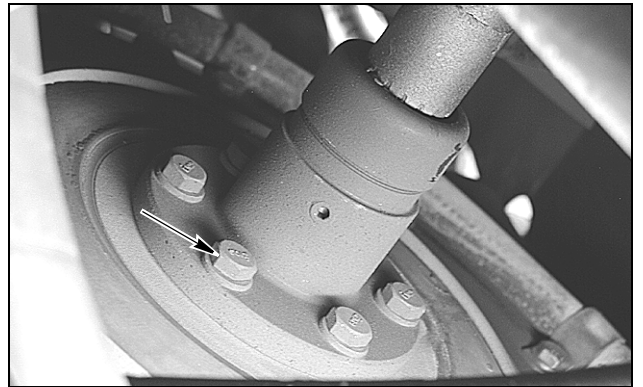

BD03A172

Remove the drive shaft bolts from the flywheel. Move the drive shaft clear of the flywheel.

STEP 40

Connect suitable lifting equipment to engine lifting brackets. Take up all slack in lifting equipment. Remove the engine mounting bolts and lift the engine enough to gain access to the drain hose, pull the drain hose with the engine.

STEP 41

Slowly raise engine from rear chassis. Be sure all harness connections and hoses have been disconnected and are clear of the engine. Remove engine from machine.

Installation

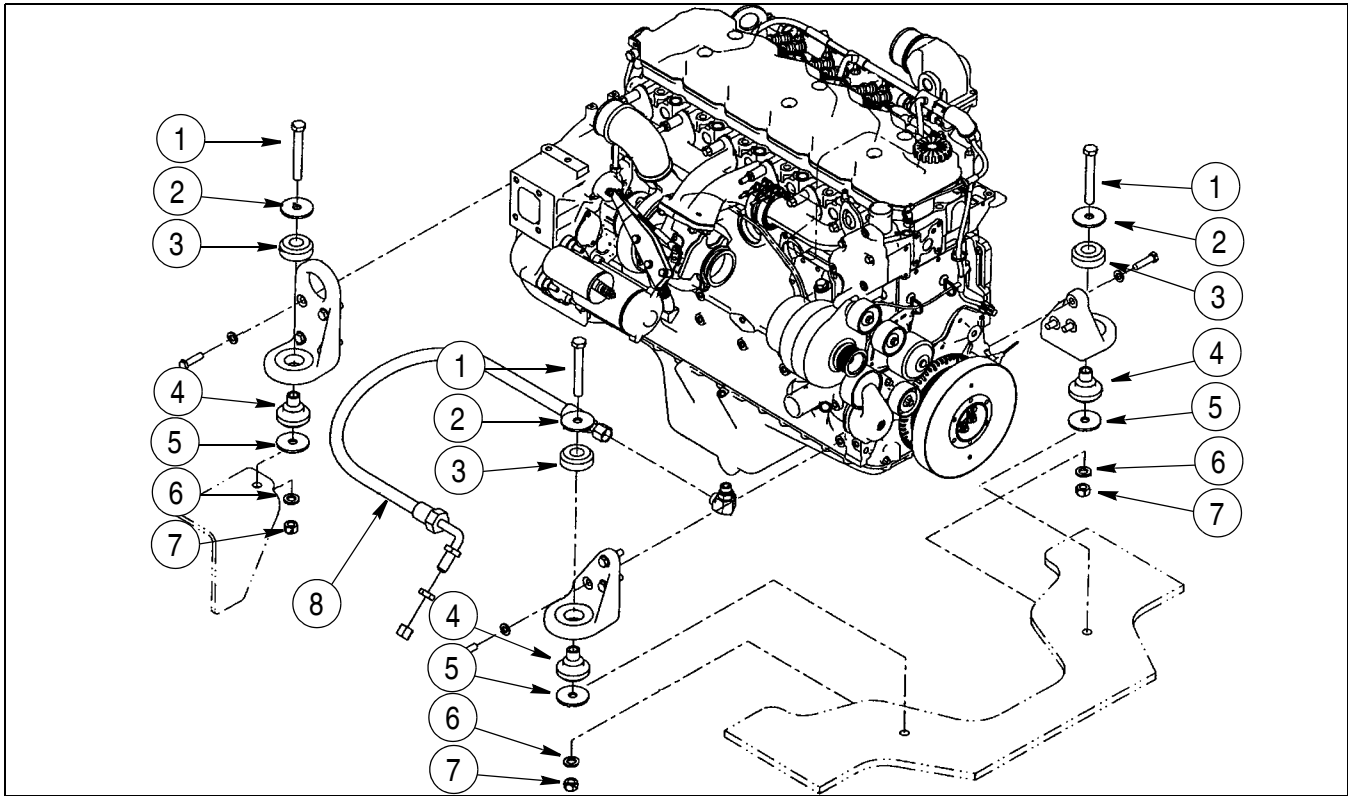

BS03B035

- | | | | |
|----------------------|--------------------|-----------|--------------------------|
| 1. ENGINE MOUNT BOLT | 3. INSOLATOR UPPER | 5. WASHER | 7. NUT |
| 2. WASHER | 4. INSOLATOR LOWER | 6. WASHER | 8. REMOTE OIL DRAIN HOSE |

STEP 42

If engine rubber isolators require replacement, remove and discard isolators (3 and 4). Install new rubber isolator (4), then rubber isolator (3).

STEP 43

Slowly raise engine and move into position over rear chassis. Be sure all harness connections and hoses are out of the way then lower engine. Put washer (5) between front rubber isolator (4) and chassis. Install washer (2), bolt (1), washer (6), and nut (7) in engine isolators. Lower engine into position.

STEP 44

Tighten engine mounting bolts to a torque of 244 to 298 Nm (180 to 220 lb-ft).

STEP 45

Disconnect lifting equipment from engine lifting brackets.

STEP 46

Connect engine oil drain hose to frame bracket.

STEP 47

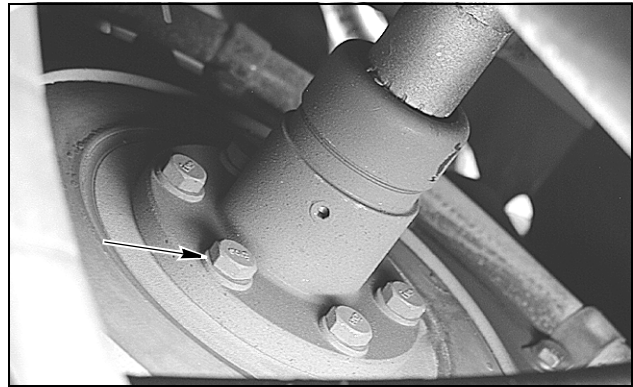

BD03A172

At front of engine, position drive shaft on engine coupling. Install six bolts to secure drive shaft to engine coupling. Tighten the six bolts to a torque of 53 to 62 Nm (39 to 46 lb-ft).

STEP 48



BD06F127

Install the lower cover for the drive shaft.

STEP 49

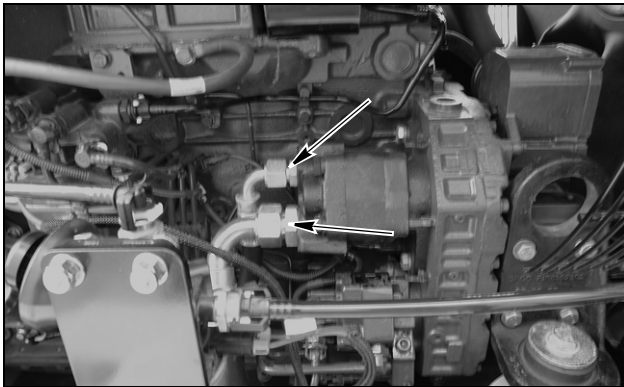

BD06F126

Connect and turn on vacuum pump to the hydraulic reservoir. Remove caps from fittings and plugs from hoses. Connect hoses to brake pump following tags installed during removal. Remove and discard tags. Turn off and disconnect vacuum pump from hydraulic reservoir.

STEP 50

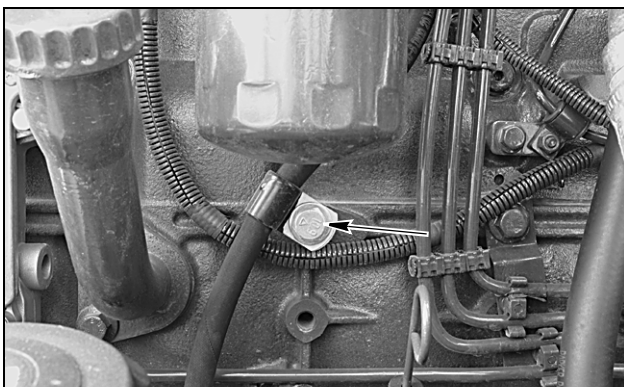

BD06F125

Install bolt and clamp for fuel return hose.

STEP 51

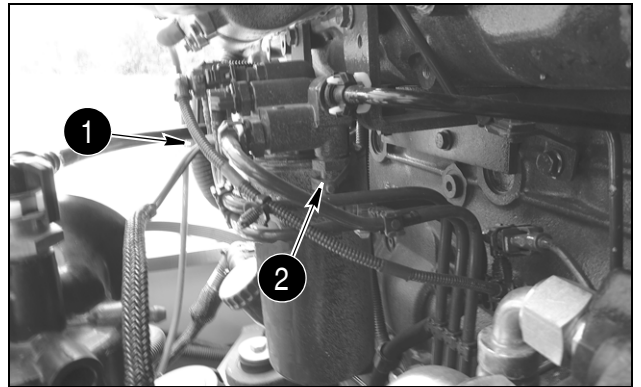

BD06F124

Remove cap from fitting and plug from the hose, connect fuel line (2). Connect fuel filter heater wires (1). Remove and discard tag.

STEP 52

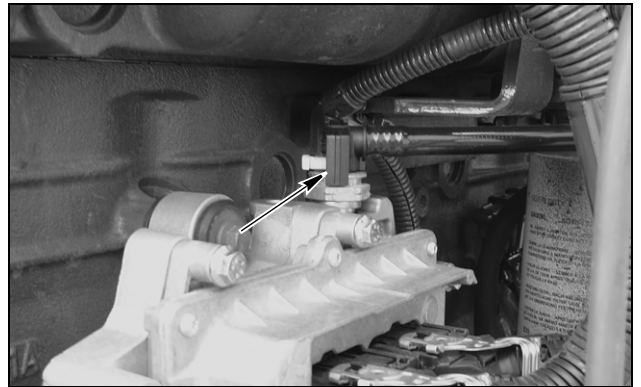

BD06F123

Remove cap from fitting and plug from the hose, connect fuel line to EDC 7.

STEP 53

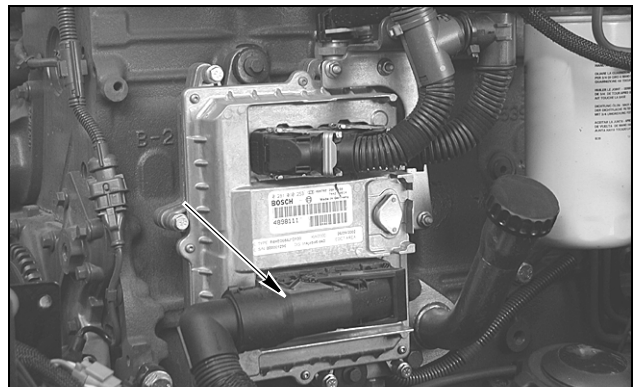

BD03A142

Connect wiring harness to EDC 7 controller.

NOTE: Start the connector on the EDC 7 with lever straight out from EDC 7. Use lever to pull connector into position.

STEP 54

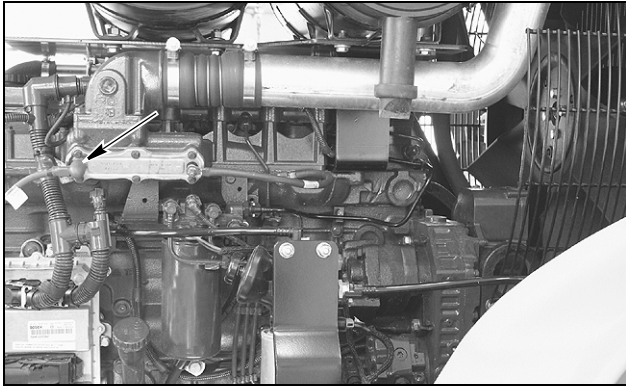

BD06F111

Connect grid heater cable to grid heater. Remove and discard tag.

STEP 55

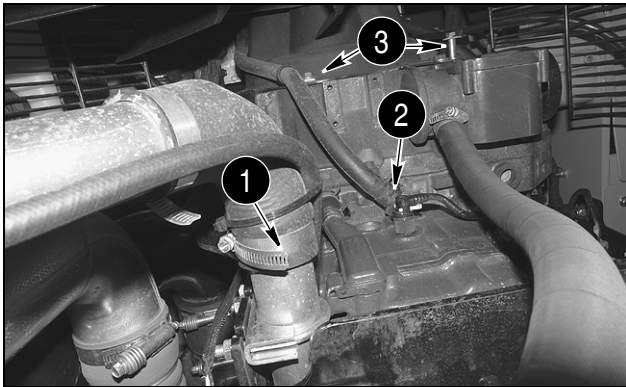

BD06F122

Install the heater hose (2) to the rear of the engine, mount the clamps (3), install the radiator hose (1).

STEP 56



BD06F146

Connect the engine coolant vent hose.

STEP 57

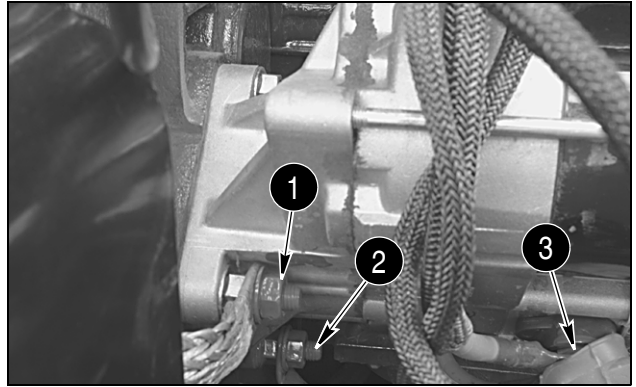

BD06F121

Install the wires to the starter solenoid (3), install the ground cable (2), and ground strap (1) to the starter. Remove and discard tags.

STEP 58

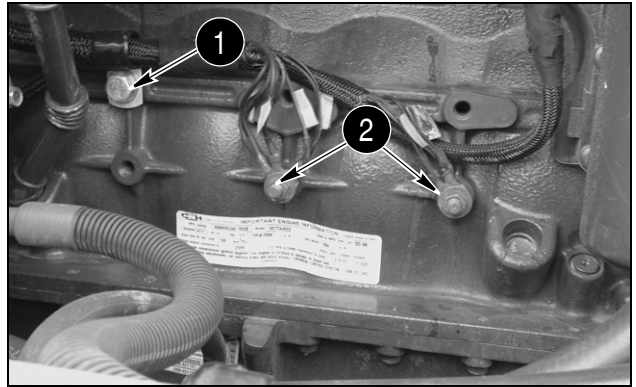

BD06F120

Install bolt securing wiring harness (1) clamp to the engine. Install ground wires (2) to the engine.

STEP 59

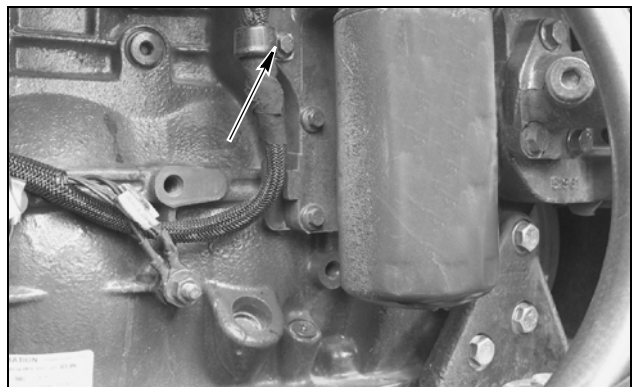

BD06F119

Install bolt securing wiring harness clamp to engine.

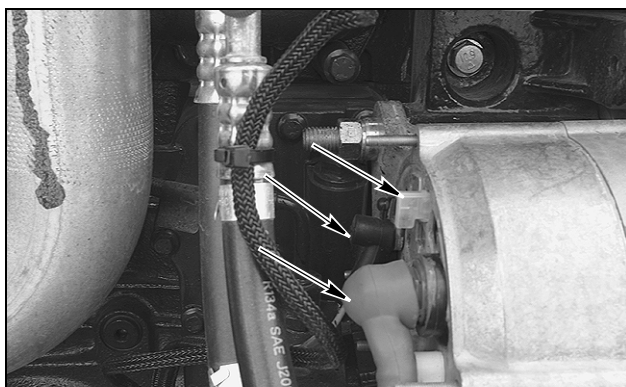
STEP 60

BD06F118

Connect the wiring to the alternator. Remove and discard tags.

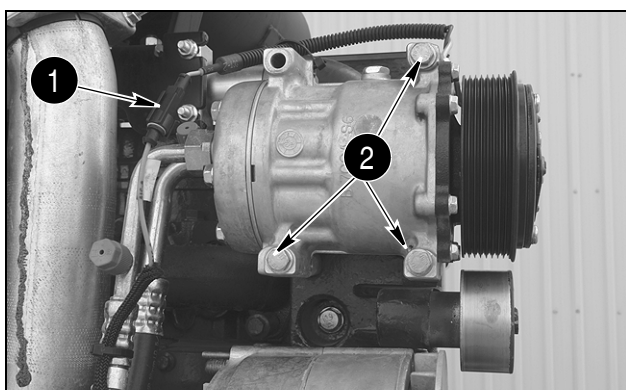
STEP 61

BD06F117

If loader is equipped with air conditioning, mount the compressor using the three mounting bolts (2), connect the engine wiring harness connectors to air compressor clutch connector (1). Remove and discard tags.

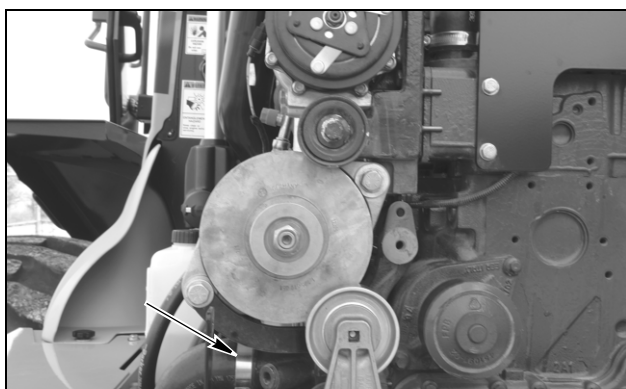
STEP 62

BD06F116

Install lower cooler hose to the engine and tighten the clamps to a torque of 10.1 to 11.3 Nm (90 to 100 lb-inch).

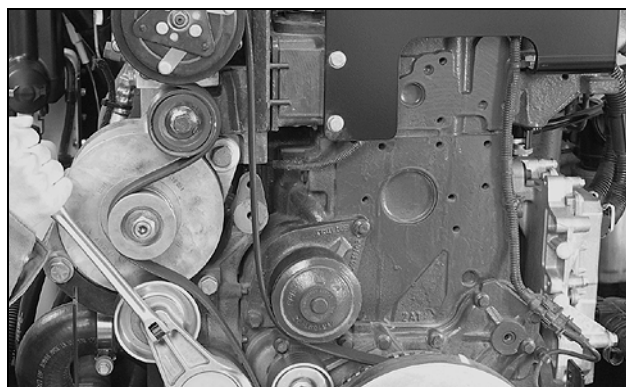
STEP 63

BD06F115

Install the drive belt.

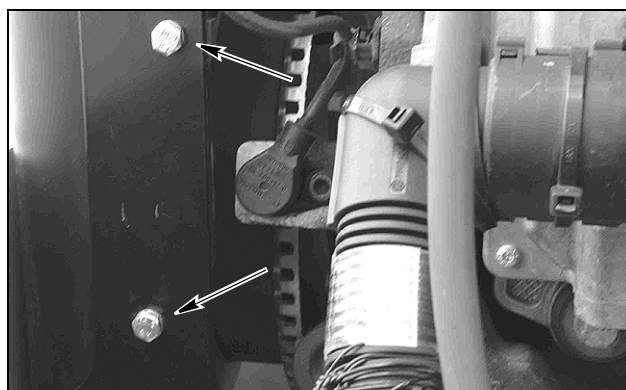
STEP 64

BD06F113

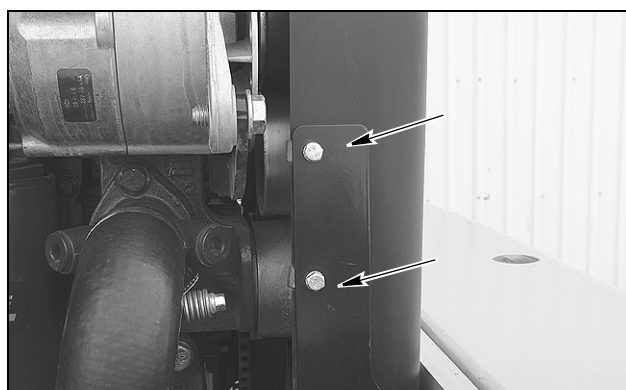

BD06F114

Install the cover mounting brackets to the machine frame. Install the belt cover, install the four mounting bolts for the belt cover.

STEP 65

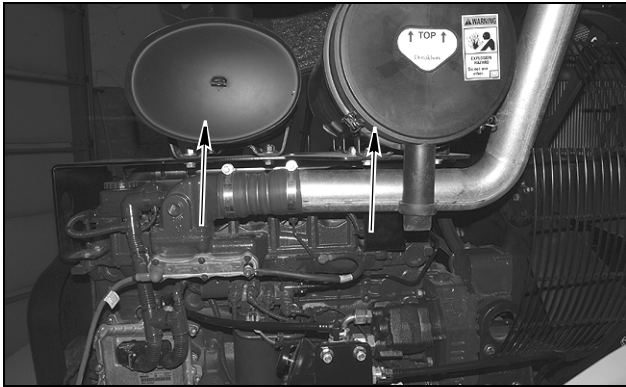

BD06F112

Place the muffler and air cleaner on the bracket. Install mounting bolts in air cleaner and tighten, install the mounting bolts in the muffler and leave loose at this time.

STEP 66

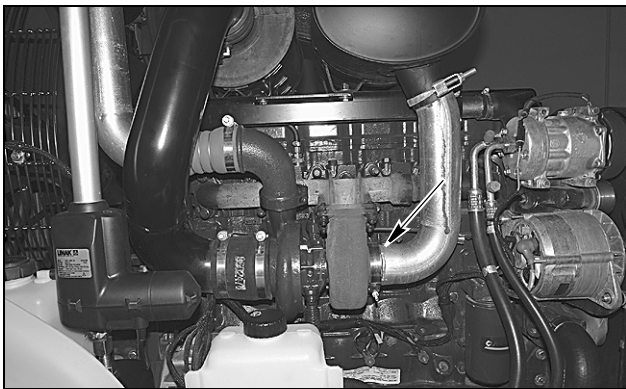

BD06F110

Install and tighten the exhaust clamp on the turbocharger, tighten the muffler mounting bolts.

STEP 67



BD03A118

Place the after cooler outlet hose on the machine. Tighten the clamp on the after cooler.

STEP 68

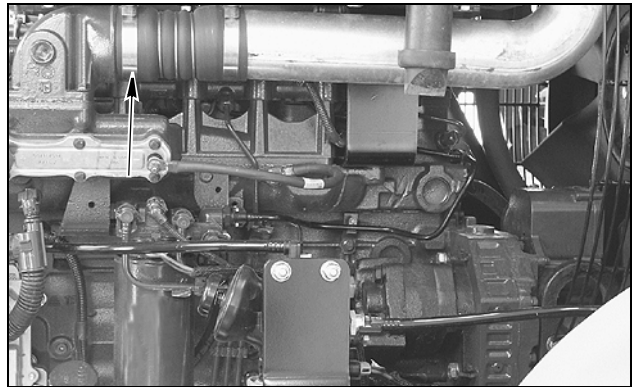

BD06F111

Tighten the clamp on the intake manifold for the after cooler output hose.

STEP 69



BD03A115

Place the after cooler inlet hose on the machine. Tighten the clamp on the after cooler.

STEP 70



BD06F110

Tighten the clamp on the turbocharger for the after cooler inlet hose.

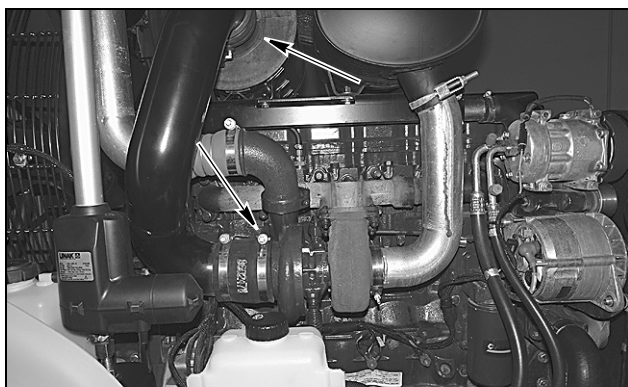
STEP 71

BD06F110

Install the intake hose and tighten the clamps on turbocharger and air cleaner.

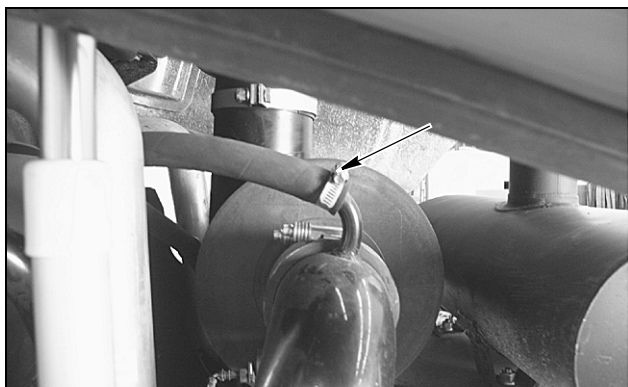
STEP 72

BD03A225

Install the crankcase ventilation hose and tighten the clamp on air cleaner intake hose.

STEP 73

BD03A224

Connect engine wiring harness connector to air filter restriction switch. Remove and discard tag.

STEP 74

BD03A232

Carefully raise and place hood over loader.

NOTE: Refer to step 7 and 8 of removal for lifting procedure.

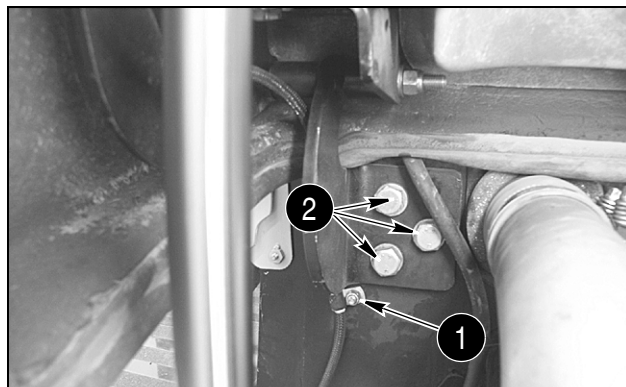
STEP 75

BD03A237

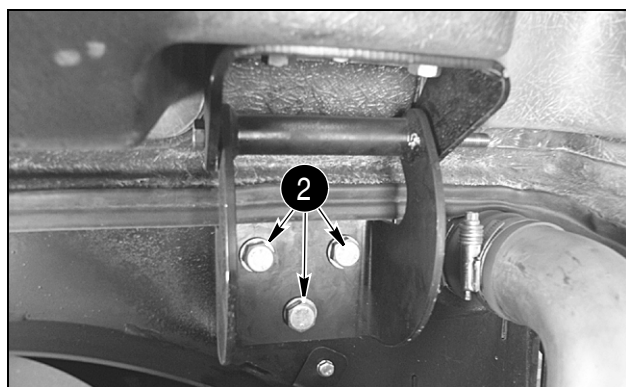

BD03A226

Have another person balance the hood, install the hood hinge mounting bolts (2) to the cooler frame. Install mount bolt (1) and backup alarm wiring harness clamp to cooler housing.

STEP 76

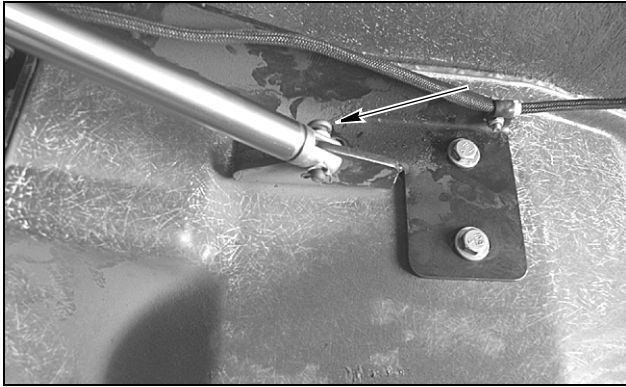

BD03A228

Install the pin from the top of the lifting motor, lower and remove lifting equipment.

STEP 77



BD06F109

Connect hood wiring harness connector to rear chassis wiring harness connector. Remove and discard tag.

STEP 78

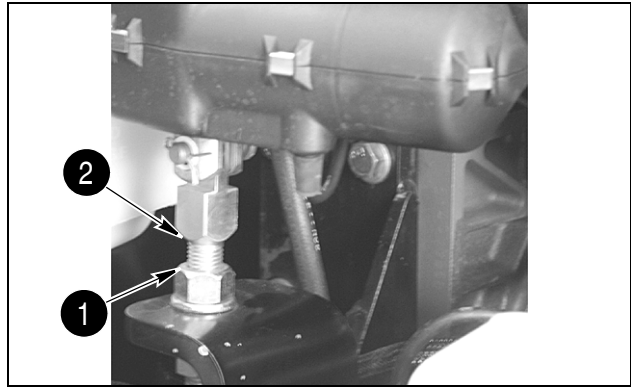

BD03A221

NOTE: If hood strut is not adjusted properly the hood will be damaged.

When a hood is removed and replaced an initial adjustment on the strut is necessary. Adjust between the top of the lift motor adjusting jam nut (1) to the top of the threads (2) to 20 mm (X). With the motor down to its lowest point take a measurement between the left hand side hood bumper and the counter weight, record this measurement (Y). Use the following table to adjust the strut (X).

Hood Adjustment Table							
Y (MM)	X (MM)	Y (MM)	X (MM)	Y (MM)	X (MM)	Y (MM)	X (MM)
1	19	21	14	41	9	61	5
2	19	22	14	42	9	62	5
3	18	23	14	43	9	63	4
4	18	24	13	44	9	64	4
5	18	25	13	45	9	65	4
6	18	26	13	46	8	66	4
7	17	27	13	47	8	67	3
8	17	28	12	48	8	68	3
9	17	29	12	49	8	69	3
10	17	30	12	50	7	70	3
11	16	31	12	51	7	71	2
12	16	32	12	52	7	72	2
13	16	33	11	53	7	73	2
14	16	34	11	54	6	74	2
15	16	35	11	55	6	75	2
16	15	36	11	56	6	76	1
17	15	37	10	57	6	77	1
18	15	38	10	58	6	78	1
19	15	39	10	59	5	79	1
20	14	40	10	60	5	80	0

STEP 79

BD02N160

Check and make sure that drain caps are tight.

STEP 80

Install a new oil filter on engine. Fill engine with 14.2 liters (15 quarts) of Case AKCELA No. 1 Engine Oil (SAE 15W-40).

STEP 81

If hydraulic reservoir was drained, fill reservoir with 105.7 liters (27.9 gallons) of Case AKCELA Hy-Tran Ultra® fluid.

STEP 82

Fill engine coolant system with a solution of 50% Ethylene Glycol and 50% water. Cooling system capacity is 36.9 liters (9.75 gallons). Install the radiator cap. Fill the coolant reservoir up to the FULL mark on the reservoir.

STEP 83

Connect the batteries, install battery covers, put master disconnect switch in ON position.

STEP 84

Start engine and run the engine at low idle. Run the engine at operating temperature for approximately five minutes to completely mix the Ethylene Glycol and water. When the coolant is at operating temperature, stop the engine. When engine has cooled, check the coolant level at the reservoir.

WARNING: Hot coolant can spray out if radiator cap is removed. To remove radiator cap: Let system cool, turn to first notch, then wait until all pressure is released. Scalding can result from fast removal of radiator cap.

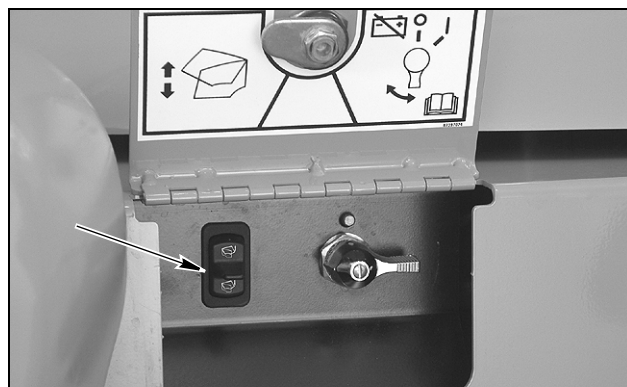
STEP 85

BD06F108

Lower the hood with the hood lift motor.

STEP 86

Put articulation lock in OPERATING position.

RADIATOR

Removal

STEP 1

Park loader on level surface and lower bucket to ground. Apply parking brake and shut down engine.

STEP 2

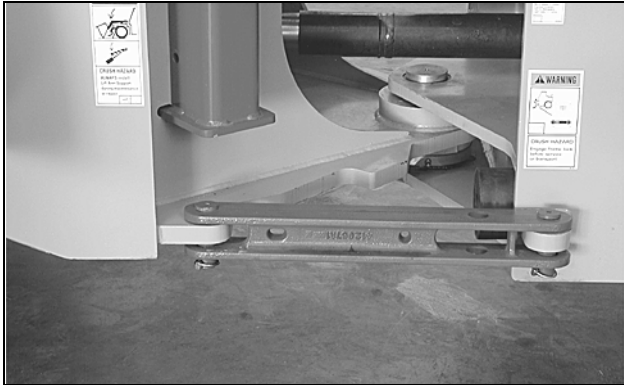

BD03A040

Put articulation lock in LOCKED position.

STEP 3

Put master disconnect switch in OFF position.

STEP 4

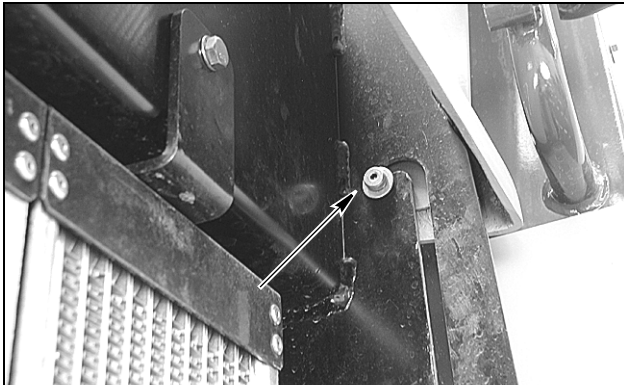

BD03A120

Have another person raise and hold the side panel up into the raised position. Remove the two mounting screws for the side panel, remove the panel.

NOTE: Photo is of the oil cooler side of the machine, the procedure is the same.

STEP 5



BD06F128

Remove bolt and washer securing LH fender. Remove LH fender.

STEP 6

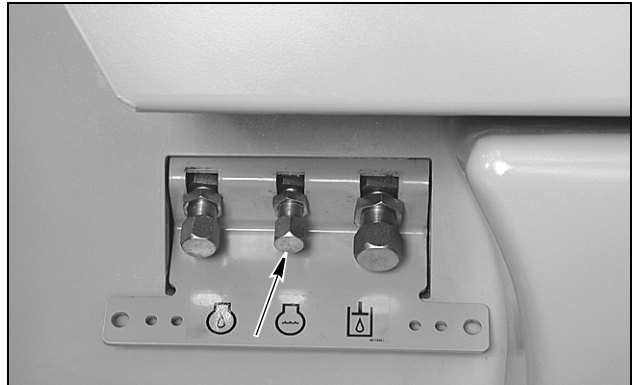

BD02N160

Put a 37 liter (10 gallon) container below radiator drain. Remove radiator cap then remove cap and drain coolant into container. Install cap after coolant has drained. Install radiator cap.

STEP 7

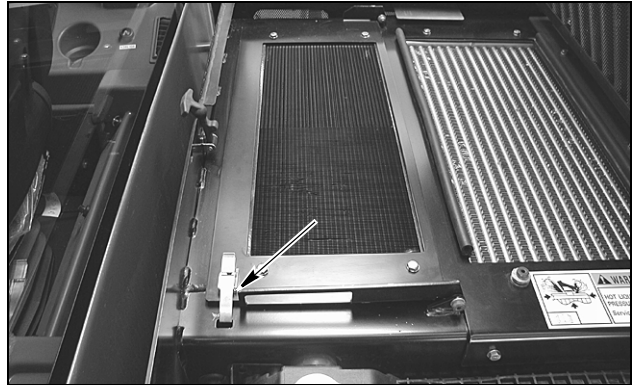

BD03A109

Release catch and tilt air conditioning condenser core up to gain access to upper radiator hose.

STEP 8

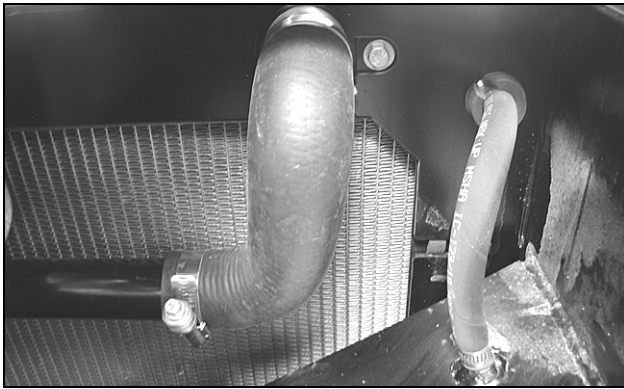

BD03A108

Loosen the upper radiator hose clamps, remove the hose.

STEP 9

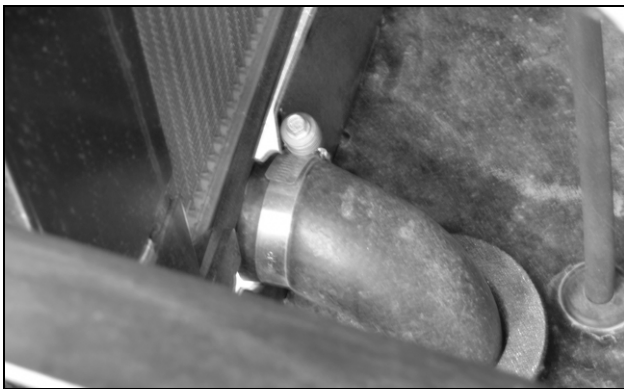

BD06F129

Loose and remove the lower radiator hose from the radiator.

STEP 10



BD03A113

Disconnect overflow hose from radiator. Disconnect connector from coolant level sender.

STEP 11

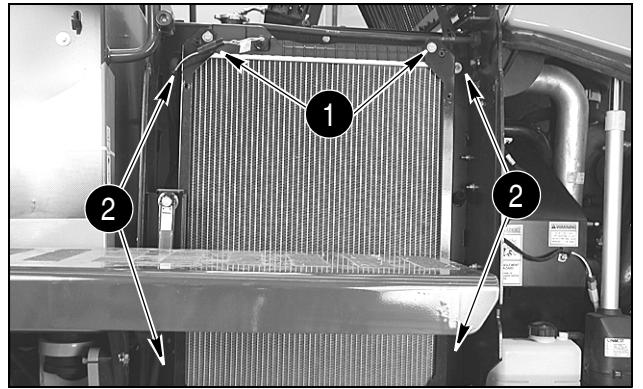

BD03A106

Remove screws and install lifting eyes (1). Attach suitable lifting equipment to lifting eyes. Remove four mounting bolts (2), remove radiator from machine.

Installation

STEP 12

Move radiator into position above cooling frame. Carefully lower radiator while guiding it into position in cooling frame.

STEP 13

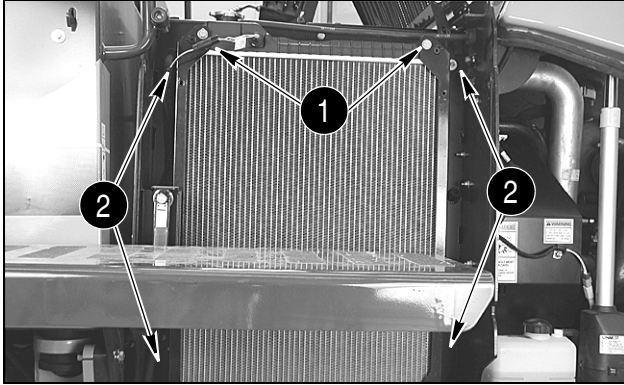

BD03A106

Install four lock washers and bolts (2) to secure radiator to cooling frame. Disconnect lifting equipment from lifting eyes. Remove lifting eyes and install screws (1).

STEP 14

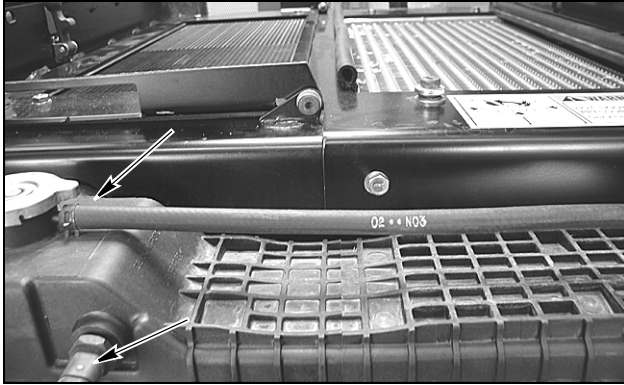

BD03A113

Connect connector to coolant level sender, connect overflow hose to radiator.

STEP 15

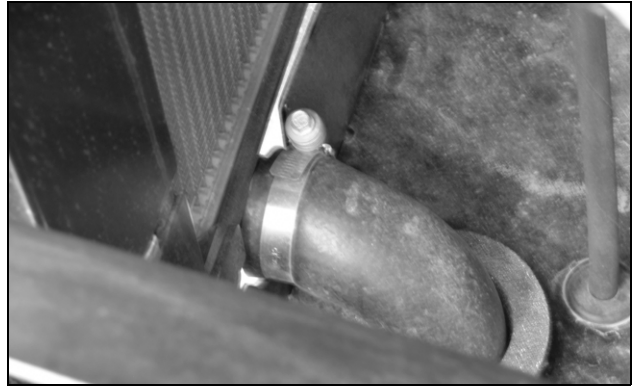

BD06F129

At bottom of radiator, install bottom radiator hose. Position and tighten two hose clamps to a torque of 10.1 to 11.3 Nm (90 to 100 lb-inch).

STEP 16

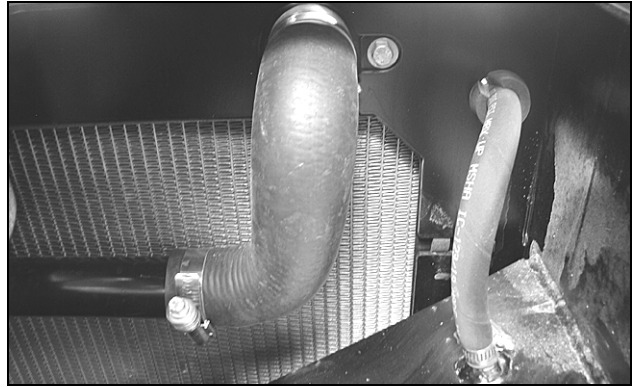

BD03A108

At top of cooling system frame, install hose. Position hose clamps and tighten to a torque of 10.1 to 11.3 Nm (90 to 100 lb-inch).

STEP 17

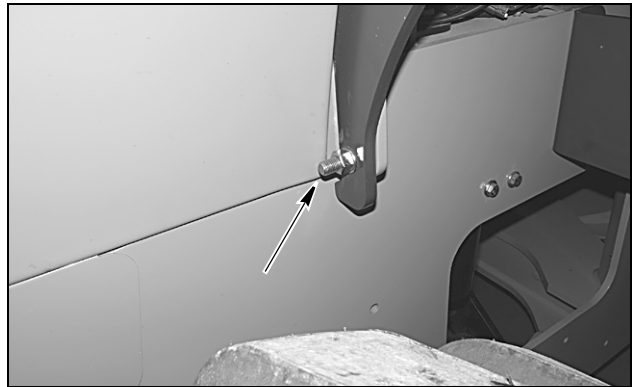

BD06F130

When installing fender make sure it is behind the fender mounting bolt.



Suggest:

If the above button click is invalid.

Please download this document

first, and then click the above link

to download the complete manual.

Thank you so much for reading

STEP 18

BD06F131

Align the hole in the fender on the bolt.

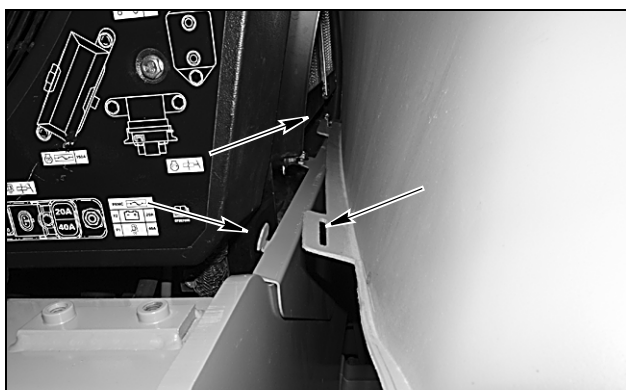
STEP 19

BD06F132

Align the slots in the fender with the tabs on the body of the machine.

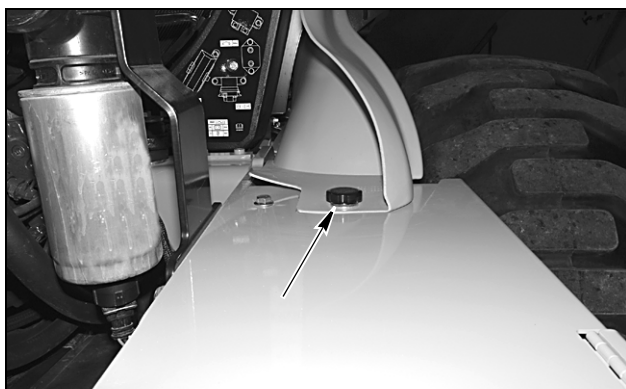
STEP 20

DSC00105.TIF

Push the fender towards the front of the machine and secure it using washer and bolt.

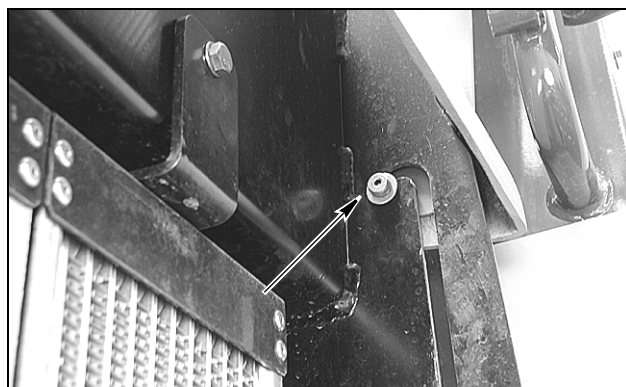
STEP 21

BD03A120

Have another person raise and hold the side panel up into position. Apply Loctite 242 to the threads, install the two mounting screws for the side panel and torque to 6.5 ± 3.0 Nm (57.5 ± 26.5 pound-inches).

NOTE: Photo is of the oil cooler side of the machine, the procedure is the same.

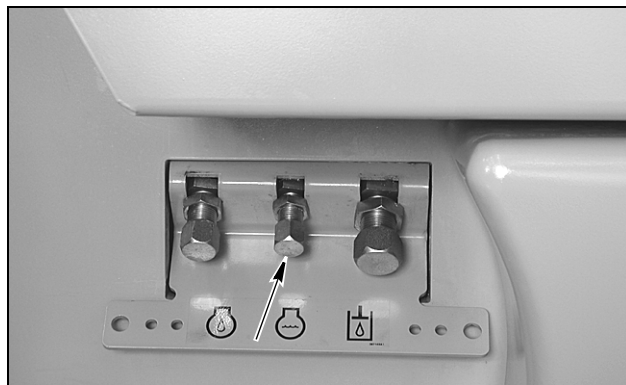
STEP 22

BD02N160

Check that coolant drain cap is tight.

STEP 23

Fill engine coolant system with a solution of 50% Ethylene Glycol and 50% water. Cooling system capacity is 36.9 liter (9.75 gallon). Install the radiator cap. Fill the coolant reservoir up to the FULL mark on the reservoir.

<https://www.ebooklibonline.com>

Hello dear friend!

Thank you very much for reading.

Enter the link into your browser.

The full manual is available for immediate download.

<https://www.ebooklibonline.com>