

521F
Wheel Loader
Tier II
Service Manual

Print No. 47476327



**521F Wheel Loader
Repair Manual
47476327**

Table of Contents

Description	Section No.
General	Tab 1
Section Index - General	
Standard Torque Specifications	1001
Fluids and Lubricants	1002
Metric Conversion Chart	1003
Engines	Tab 2
Section Index - Engines	
Engine and Radiator Removal and Installation	2000
Stall Tests	2002
After Cooler	2003
For Engine Repair, See the Engine Service Manual 84392428	
Fuel System	Tab 3
Section Index - Fuel System	
For Fuel System Repair, See the Engine Service Manual 84392428	
Electrical	Tab 4
Section Index - Electrical	
Removal and Installation of Starter and Alternator	4001
Electrical Specifications and Troubleshooting - Electrical Schematic	4002
Batteries	4003
Instrument Cluster	4005
Steering	Tab 5
Section Index - Steering	
Removal and Installation of Steering Components	5001
Steering Specifications, Pressure Checks, and Troubleshooting	5002
Steering Cylinders	5005
Center Pivot	5006
Auxiliary Steering Motor and Pump	5008
Joystick Steering System (JSS)	5009

521F Wheel Loader Repair Manual 47476327

Table of Contents

Description	Section No.
Power Train	Tab 6
Section Index - Power Train	
Removal and Installation of Power Train Components	6001
Transmission Specifications, Pressure Checks, and Troubleshooting	6002
Transmission	6003
Front Axle	6004
Rear Axle	6004
Drive Shafts, Center Bearing, and Universal Joints	6005
Wheels and Tires	6006
Transmission Control Valve	6007
Brakes	Tab 7
Section Index - Brakes	
Removal and Installation of Brake Components	7001
Hydraulic Brake Troubleshooting	7002
Brake Pump	7003
Brake Accumulators	7004
Parking Brake	7008
Hydraulics	Tab 8
Section Index - Hydraulics	
How to Read Hydraulic Schematics	8000
Removal and Installation of Hydraulic Components	8001
Hydraulic Specifications, Troubleshooting, and Pressure Checks	8002
Cleaning the Hydraulic System	8003
Loader Control Valve	8005
Cylinders	8006
Coupler Solenoid Locking Valve	8007
Ride Control Accumulator	8013
Ride Control Valve	8014
Mounted Equipment	Tab 9

<https://www.ebooklibonline.com>

Hello dear friend!

Thank you very much for reading.

Enter the link into your browser.

The full manual is available for immediate download.

<https://www.ebooklibonline.com>

**521F Wheel Loader
Repair Manual
47476327**

Table of Contents

Description	Section No.
Section Index - Mounted Equipment	
Air Conditioning Troubleshooting and System Checks	9002
Air Conditioner System Service	9003
Removal And Installation Of Air Conditioning And Heater Components	9004
Loader	9006
Roll Over Protective Structure (ROPS), Cab Structural Frame (CSF)	9007
Cab Glass Installation	9010
Hydraulic Schematic Foldout	In Rear Pocket

SECTION INDEX

GENERAL

Section Title	Section Number
Standard Torque Specifications	1001
Fluids and Lubricants	1002
Metric Conversion Chart	1003

TORQUE SPECIFICATIONS - DECIMAL HARDWARE

Use the torques in this chart when special torques are not given. These torques apply to fasteners with both UNC and UNF threads as received from suppliers dry, or when lubricated with engine oil. Not applicable if special graphities, Molydisulfide greases, or other extreme pressure lubricants are used.

Grade 5 Bolts, Nuts, and Studs		
		
Size	Pound-Inches	Newton metres
1/4 inch	108 to 132	12 to 15
5/16 inch	204 to 252	23 to 28
3/8 inch	420 to 504	48 to 57
Size	Pound-Feet	Newton metres
7/16 inch	54 to 64	73 to 87
1/2 inch	80 to 96	109 to 130
9/16 inch	110 to 132	149 to 179
5/8 inch	150 to 180	203 to 244
3/4 inch	270 to 324	366 to 439
7/8 inch	400 to 480	542 to 651
1.0 inch	580 to 696	787 to 944
1-1/8 inch	800 to 880	1085 to 1193
1-1/4 inch	1120 to 1240	1519 to 1681
1-3/8 inch	1460 to 1680	1980 to 2278
1-1/2 inch	1940 to 2200	2631 to 2983

Grade 8 Bolts, Nuts, and Studs		
		
Size	Pound-Inches	Newton metres
1/4 inch	144 to 180	16 to 20
5/16 inch	288 to 348	33 to 39
3/8 inch	540 to 648	61 to 73
Size	Pound-Feet	Newton metres
7/16 inch	70 to 84	95 to 114
1/2 inch	110 to 132	149 to 179
9/16 inch	160 to 192	217 to 260
5/8 inch	220 to 264	298 to 358
3/4 inch	380 to 456	515 to 618
7/8 inch	600 to 720	814 to 976
1.0 inch	900 to 1080	1220 to 1465
1-1/8 inch	1280 to 1440	1736 to 1953
1-1/4 inch	1820 to 2000	2468 to 2712
1-3/8 inch	2380 to 2720	3227 to 3688
1-1/2 inch	3160 to 3560	4285 to 4827

NOTE: Use thick nuts with Grade 8 bolts.

TORQUE SPECIFICATIONS - METRIC HARDWARE

Use the following torques when specifications are not given.

These values apply to fasteners with coarse threads as received from supplier, plated or unplated, or when lubricated with engine oil. These values do not apply if graphite or Molydisulfide grease or oil is used.

Grade 8.8 Bolts, Nuts, and Studs		
		
Size	Pound-Inches	Newton metres
M4	24 to 36	3 to 4
M5	60 to 72	7 to 8
M6	96 to 108	11 to 12
M8	228 to 276	26 to 31
M10	456 to 540	52 to 61
Size	Pound-Feet	Newton metres
M12	66 to 79	90 to 107
M14	106 to 127	144 to 172
M16	160 to 200	217 to 271
M20	320 to 380	434 to 515
M24	500 to 600	675 to 815
M30	920 to 1100	1250 to 1500
M36	1600 to 1950	2175 to 2600

Grade 10.9 Bolts, Nuts, and Studs		
		
Size	Pound-Inches	Newton metres
M4	36 to 48	4 to 5
M5	84 to 96	9 to 11
M6	132 to 156	15 to 18
M8	324 to 384	37 to 43
Size	Pound-Feet	Newton metres
M10	54 to 64	73 to 87
M12	93 to 112	125 to 150
M14	149 to 179	200 to 245
M16	230 to 280	310 to 380
M20	450 to 540	610 to 730
M24	780 to 940	1050 to 1275
M30	1470 to 1770	2000 to 2400
M36	2580 to 3090	3500 to 4200

Grade 12.9 Bolts, Nuts, and Studs

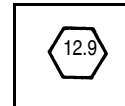

Usually the torque values specified for grade 10.9 fasteners can be used satisfactorily on grade 12.9 fasteners.

Section 2000

**ENGINE AND RADIATOR REMOVAL AND
INSTALLATION**

ENGINE

Removal

STEP 1

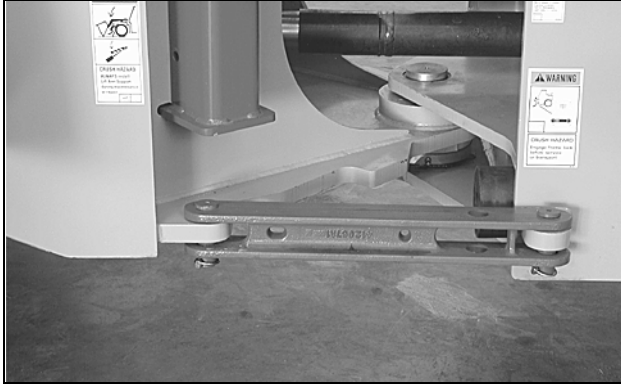

BD03A040

Park machine on a level surface and lower bucket to ground. Put articulation lock in LOCKED position.

STEP 2

Stop engine. Actuate brake pedal several times to discharge brake accumulators. Put key switch in ON position and move loader control lever back and forth at least 30 times to release any pressure from hydraulic circuit. Put key switch in OFF position.

STEP 3

Slowly loosen the filler cap for hydraulic reservoir to release air pressure in hydraulic reservoir.

STEP 4

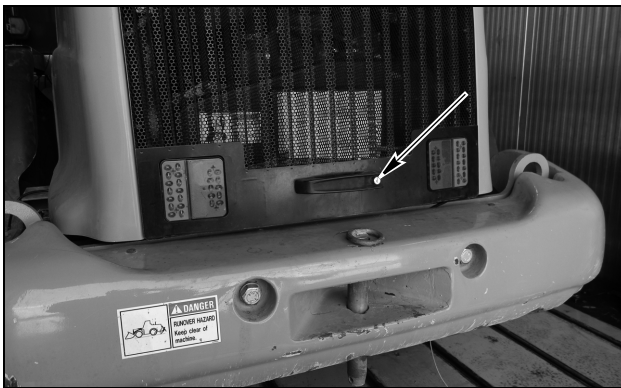

W110R381

The master switch disconnect is located under the hood on the left read side of the machine. Raise the hood put master disconnect switch in OFF position.

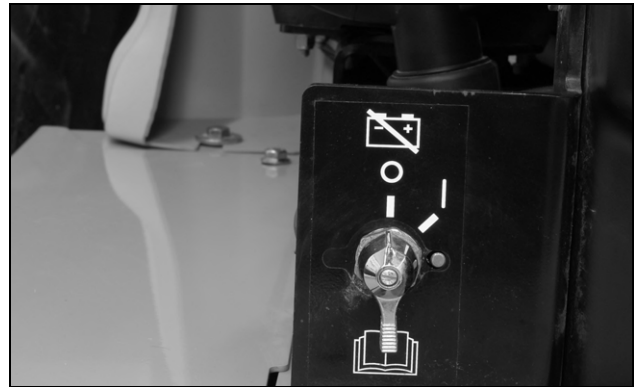

W110R381

STEP 5

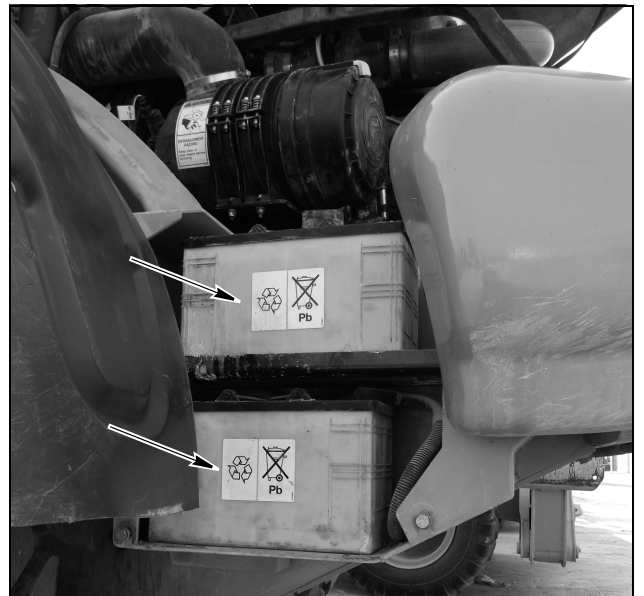

W110R383

Remove both battery covers and disconnect batteries from the machine.

STEP 6

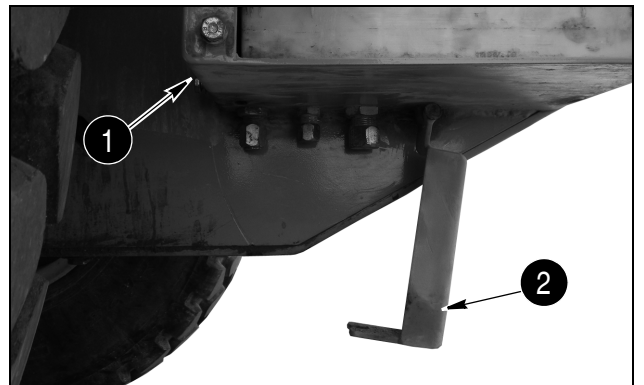

W110R382

Loosen the screw (1) and open the access cover (2).

2000-4

STEP 7

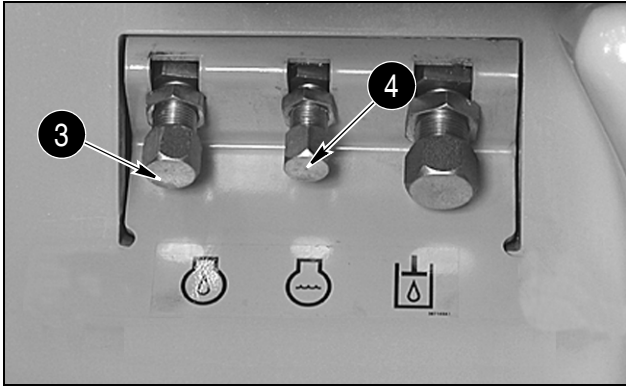

BD02N160

Put a container capable of holding at least 22.7 liter (6.0 gallon) below radiator drain. Remove radiator cap (4). Remove cap and drain coolant into container. Install cap after coolant has drained. Install radiator cap.

Put a container capable of holding at least 12.3 liter (13 U.S. quarts) below engine oil drain. Remove cap (3) and drain oil into container. Install cap after oil has drained.

NOTE: After draining oil disconnect drain hose from frame for removal with engine.

STEP 8

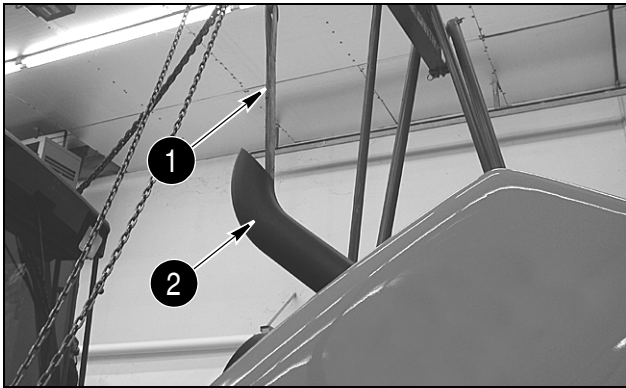

BD03A231

Double up a nylon lifting strap (1) and slide through the exhaust stack (2) on the hood.

STEP 9

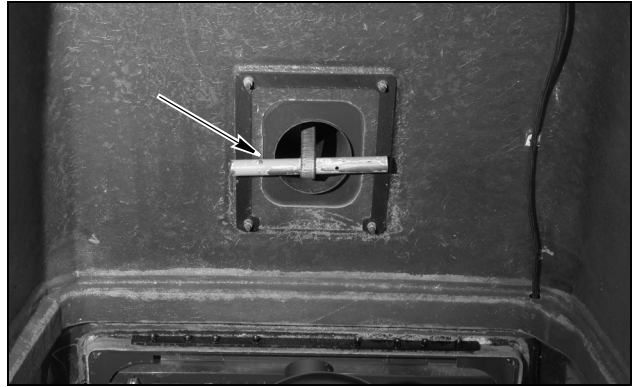

BD07N564-01

Place a solid steel bar through the strap, raise the hood and release tension on the lifting motor.

STEP 10

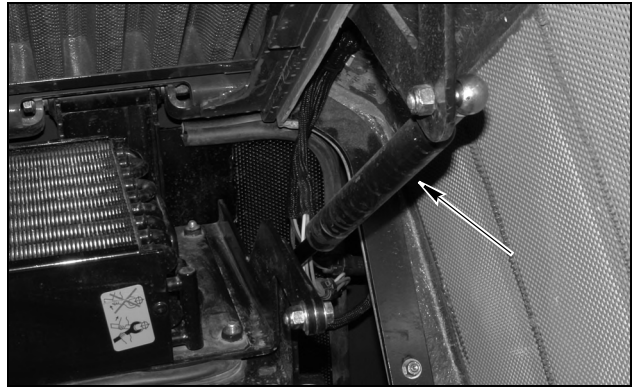

BD07N597-01

Remove the right front lift cylinder from the hood. Repeat the procedure for the left hand side.

STEP 11



W110R384

Remove the rear lift cylinder from the machine.

STEP 12

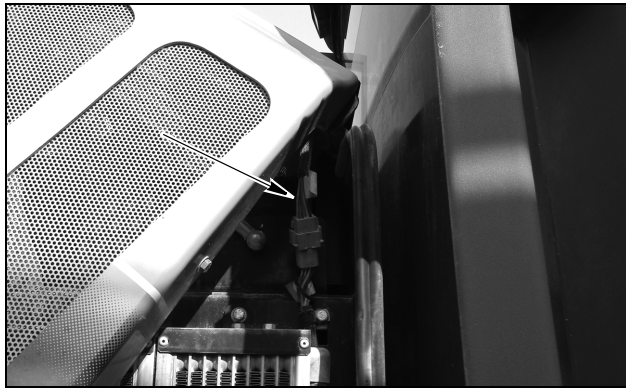

W110R385

Tag and disconnect hood wiring harness connector and backup alarm connector from rear chassis wiring harness connector.

STEP 13

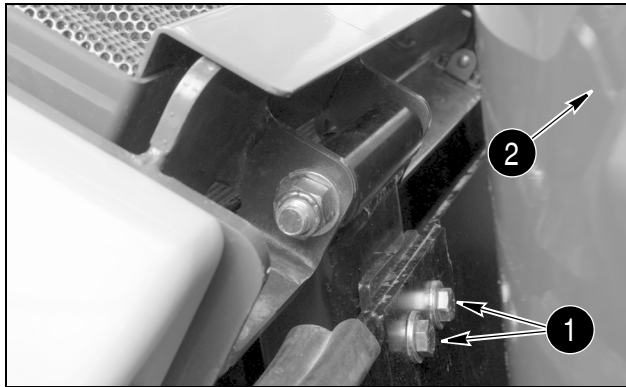

BD07N567-01

Have another person balance the hood, and remove the hood hinge mounting bolts (1) located outside the hood by the cab (2) from the cooler frame. Repeat procedure for the other side.

STEP 14



BD03A232

Carefully raise and remove hood from loader. Lower hood onto suitable platform and disconnect lifting equipment.

STEP 15



W110R386

Tag and disconnect engine wiring harness connector from air filter restriction switch.

STEP 16



BD07N569-01

Loosen clamp on air cleaner intake hose and remove the crankcase ventilation hose.

STEP 17



W110R387

Loosen clamps on turbocharger and air cleaner, remove the intake hose.

2000-6

STEP 18

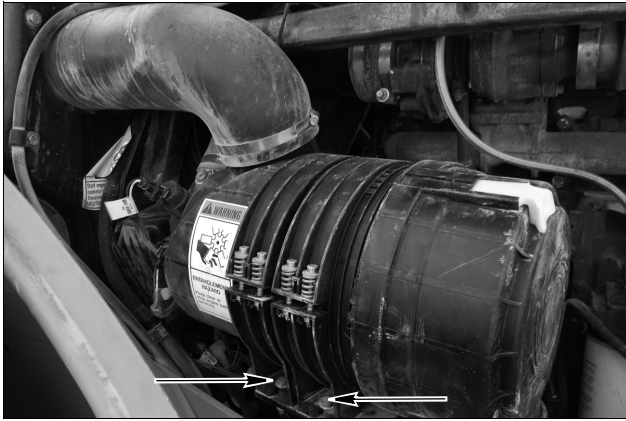

W110R388

Remove the air cleaner by removing the four bolts.

STEP 19



W110R389

Loosen the clamp on the turbocharger for the after cooler inlet hose.

STEP 20



W110R390

Loosen the clamp on the after cooler and remove the after cooler inlet hose from the machine.

STEP 21

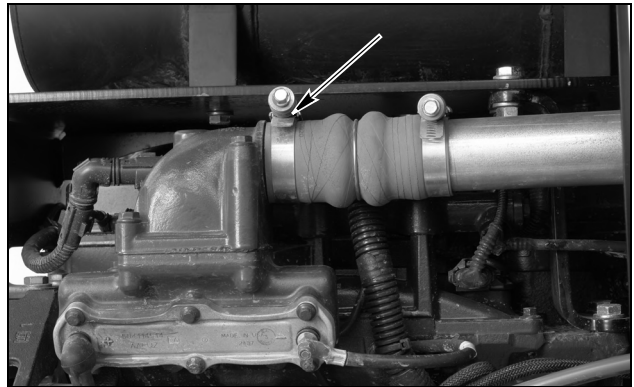

BD07N570-01

Loosen the clamp on the intake manifold for the after cooler output hose.

STEP 22

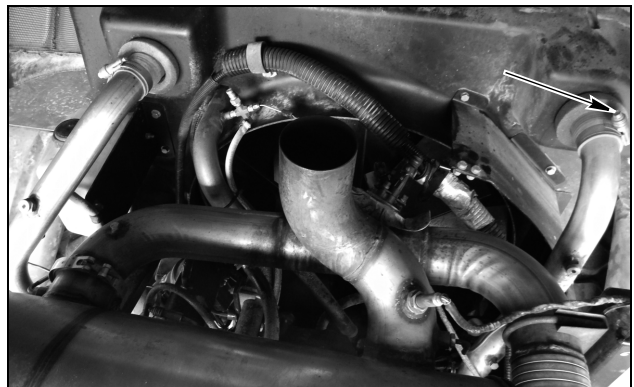

W110R391

Loosen the clamp on the after cooler and remove the after cooler outlet hose from the machine.

STEP 23



W110R392

Loosen the exhaust clamp from the turbocharger.

STEP 24

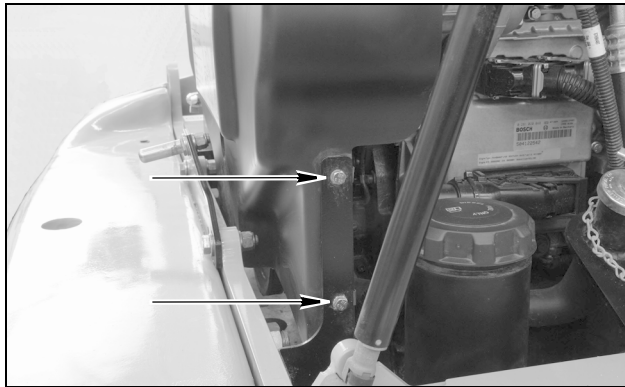

BD07N600-01

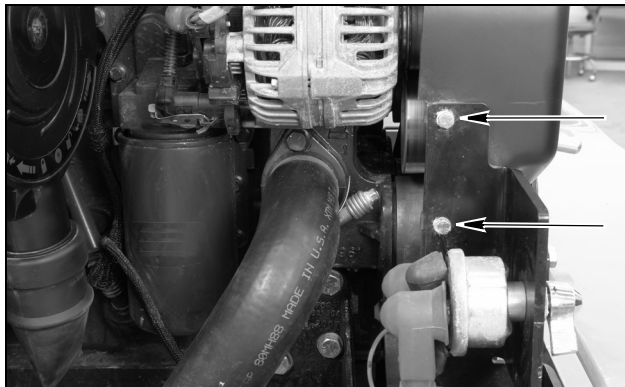

BD07N573-01

Remove the four mounting bolts from the belt cover, remove the cover. Disconnect the master switch wiring.

NOTE: After removing the belt cover remove the cover mounting brackets from the machine frame.

STEP 25



BD07N576-01

Remove the drive belt from the engine.

STEP 26

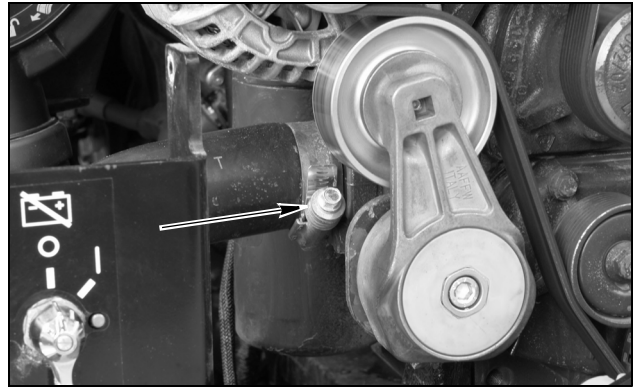

BD07N577-01

Loosen clamps and remove lower cooler hose from the engine.

STEP 27

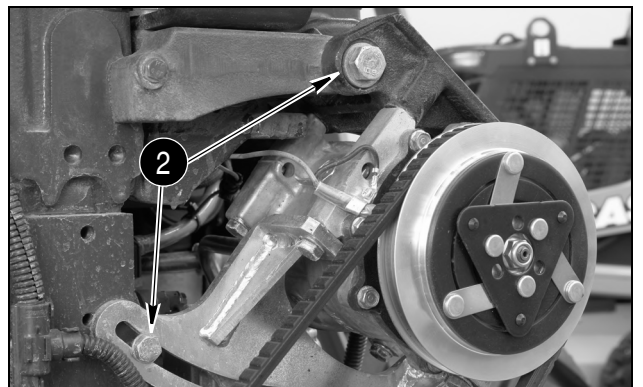

BD07N579-01



W110R395

If loader is equipped with air conditioning, identify, tag, and disconnect the engine wiring harness connectors from air compressor clutch connector (1). Remove the two mounting bolts (2) for the compressor and set the compressor on the left battery cover.

2000-8

STEP 28

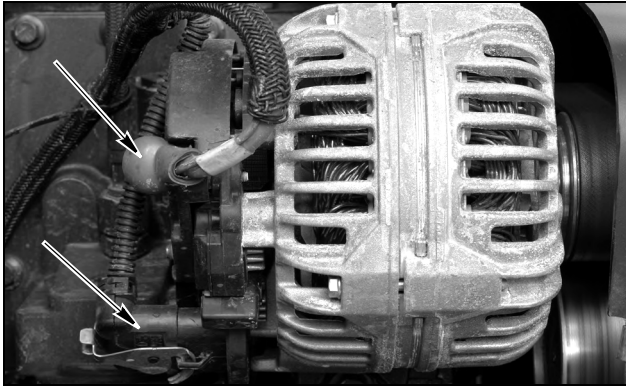

BD07N575-01

Tag and disconnect the wiring from the alternator.

STEP 29

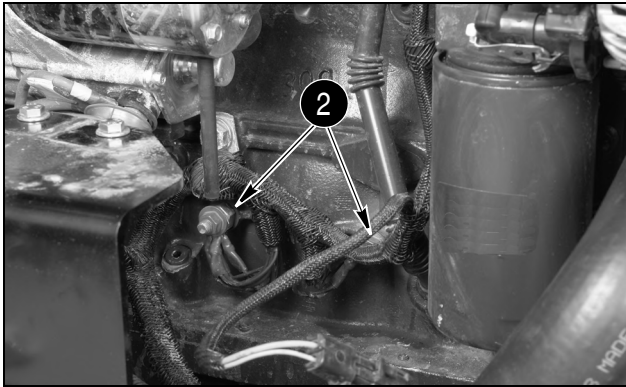

BD07N580-01

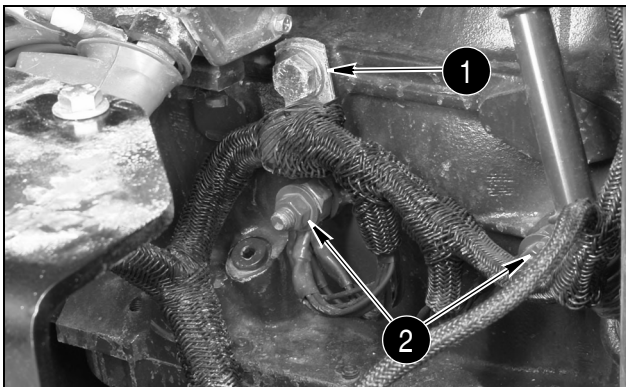

BD07N582-01

Remove bolt securing wiring harness clamp (1) to the engine. Remove ground wires (2) from the engine.

STEP 30

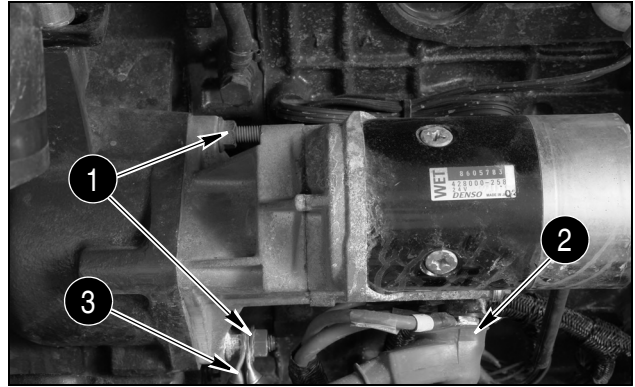

BD07N581-01

Tag and remove the wires from the starter solenoid (2), remove the ground cable and ground strap (3) from the starter. Then remove the two mounting bolts (1).

NOTE: Move the starter cables away from the engine, move the wiring harness away from the engine.

STEP 31

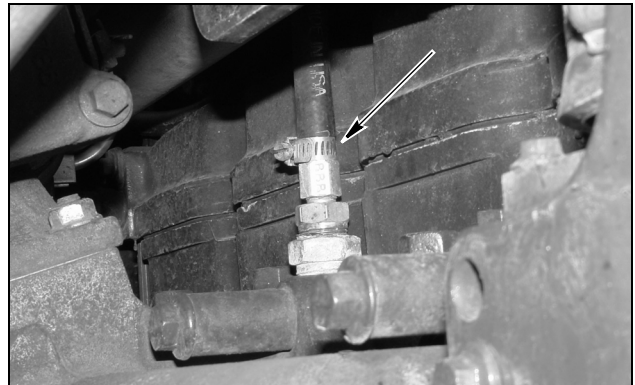

BD07N599-01

Disconnect the engine coolant vent hose and route to the rear of the engine.

STEP 32

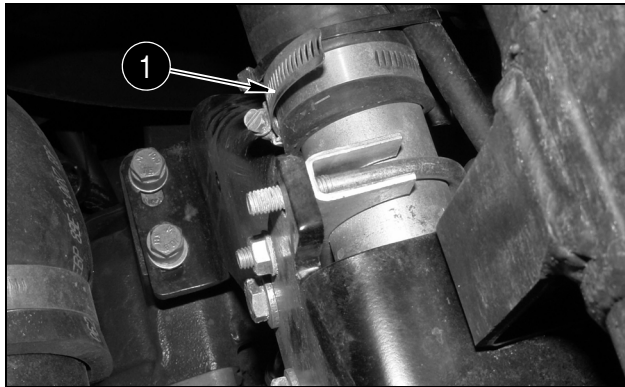

BD07N596-01

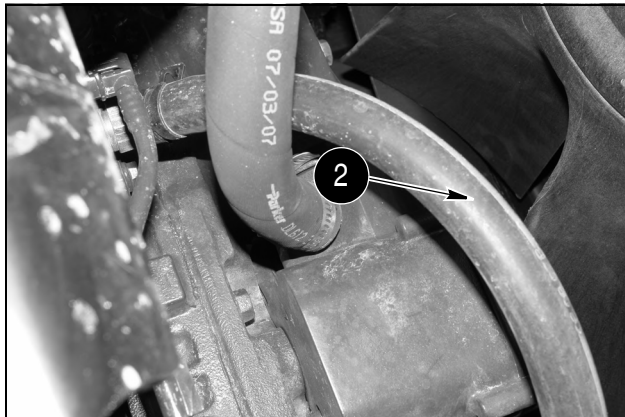

BD07N583-01

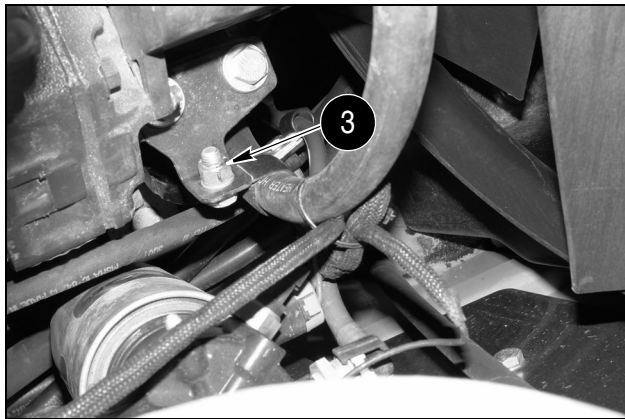

BD07N584-01

Remove the radiator hose (1) from the rear of the engine, remove the heater hose from the rear of the engine (2), remove the clamp bolts and clamps (3) from the bell housing.

STEP 33

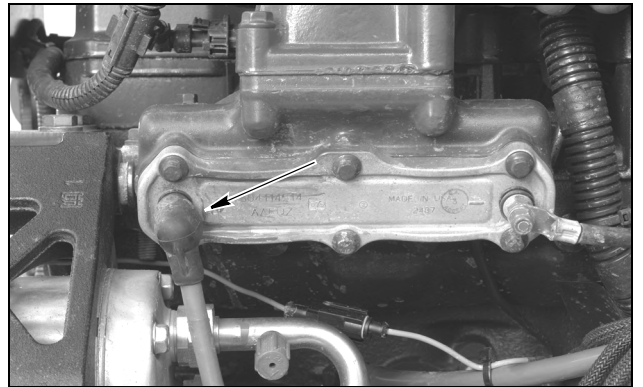

BD07N585-01

Tag and remove the grid heater cable.

STEP 34



BD07N586-01

Disconnect the wiring harness from the EDC 7 controller.

NOTE: *Lifting up on the lever will release the connector from the controller.*

STEP 35



BD07N591-01

Remove the fuel line from the top of the EDC 7 controller, plug the line and cap the fitting.

2000-10

STEP 36

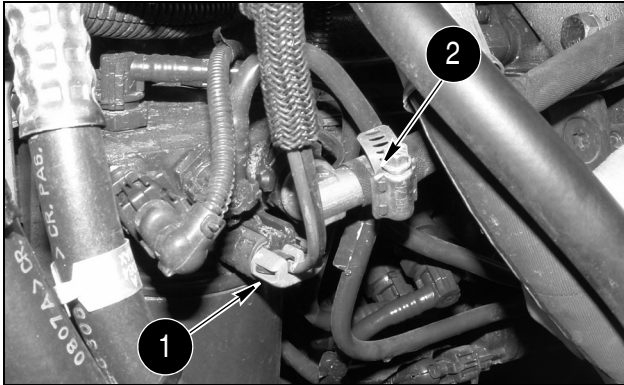

Tag and disconnect the fuel filter heater wires (1), disconnect the fuel line (2) from the fuel filter head, plug the line and cap the fitting.

STEP 37

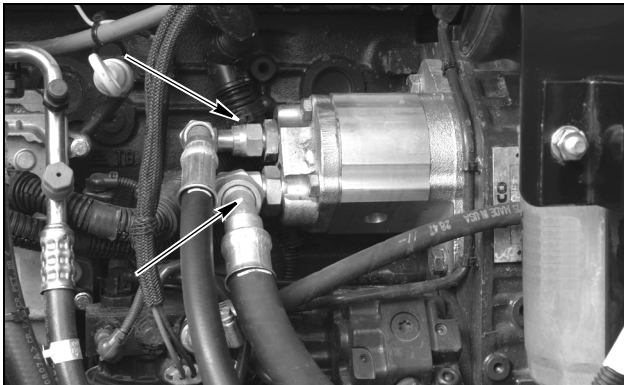

Connect and turn on vacuum pump to hydraulic reservoir. Tag and remove the hydraulic lines from the brake system pump, plug the lines and cap the fittings.

STEP 38

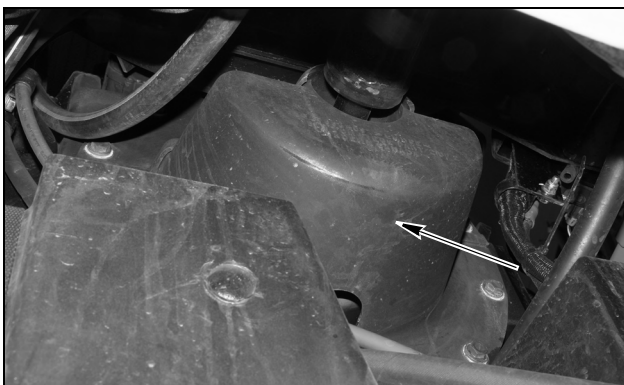

Remove the lower cover for the drive shaft.

STEP 39

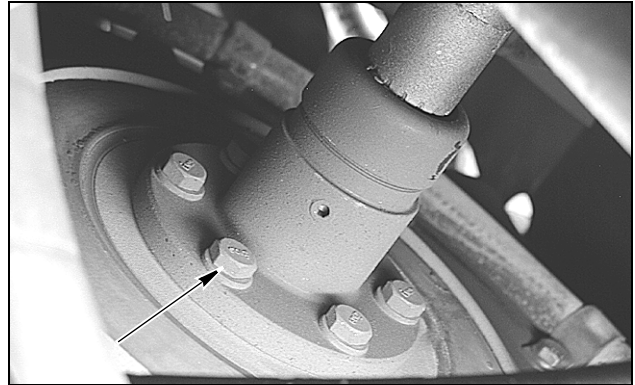

Remove the drive shaft bolts from the flywheel. Move the drive shaft clear of the flywheel.

STEP 40

Connect suitable lifting equipment to engine lifting brackets. Take up all slack in lifting equipment. Remove the engine mounting bolts and lift the engine enough to gain access to the drain hose, pull the engine oil drain hose with the engine.

STEP 41

Slowly raise engine from rear chassis. Be sure all harness connections and hoses have been disconnected and are clear of the engine. Remove engine from machine.

Installation

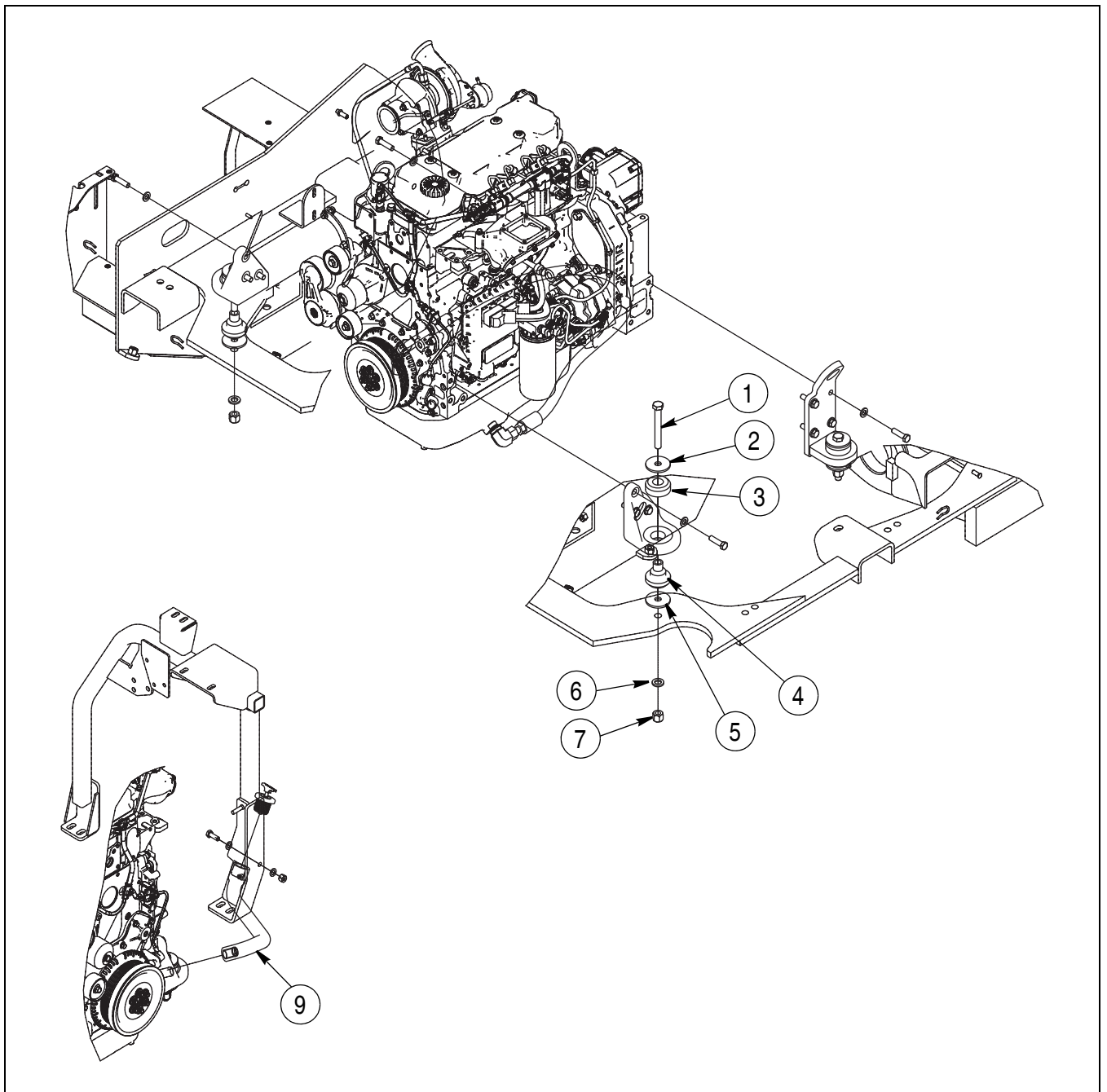

W110R468

ENGINE INSTALLATION

- | | | | | |
|---|--------------------|-----------|--------------------------|------------------|
| 1. ENGINE MOUNT BOLT,
244-298 NM (182-220 LB-FT) | 3. INSULATOR UPPER | 5. WASHER | 7. NUT | 9. OIL FILL TUBE |
| 2. WASHER | 4. INSULATOR LOWER | 6. WASHER | 8. REMOTE OIL DRAIN HOSE | |

STEP 42

If engine rubber isolators require replacement, remove and discard isolators (3 and 4). Install new rubber isolator (4), then rubber isolator (3).

STEP 43

Slowly raise engine and move into position over rear chassis. Be sure all harness connections and hoses are out of the way then lower engine. Put washer (5) between front rubber isolator (4) and chassis. Install washer (2), bolt (1), washer (6), and nut (7) in engine isolators. Lower engine into position.

2000-12

STEP 44

Tighten engine mounting bolts to a torque of 244 to 298 Nm (180 to 220 lb-ft).

STEP 45

Disconnect lifting equipment from engine lifting brackets.

STEP 46

Connect engine oil drain hose to frame bracket.

STEP 47

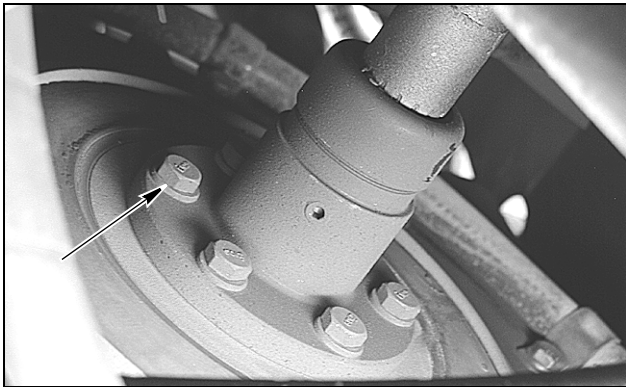

BD03A172

At front of engine, position drive shaft on engine coupling. Install six bolts to secure drive shaft to engine coupling. Apply Loctite 242 to threads and tighten the six bolts to a torque of 53 to 62 Nm (39 to 46 lb-ft).

STEP 48

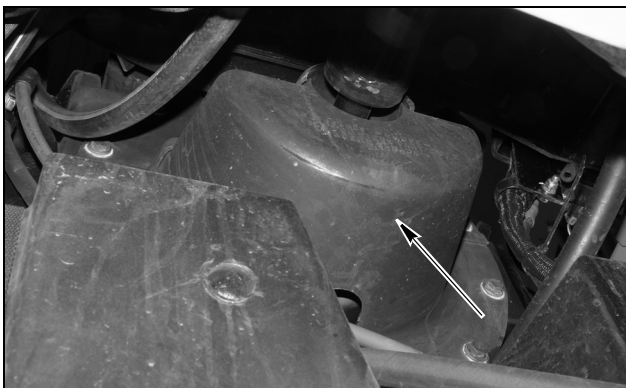

BD07N589-01

Install the lower cover for the drive shaft.

STEP 49

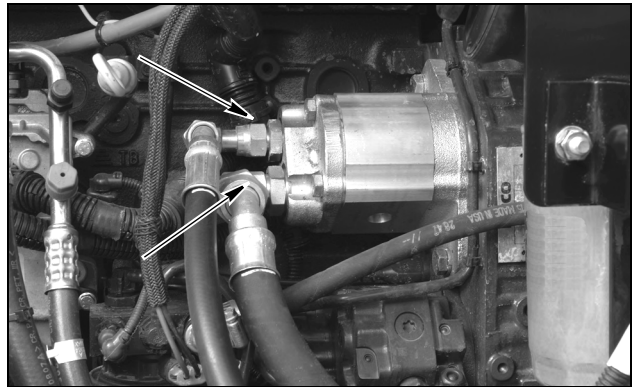

BD07N588-01

Connect and turn on vacuum pump to the hydraulic reservoir. Remove caps from fittings and plugs from hoses. Connect hoses to brake pump following tags installed during removal. Remove and discard tags. Turn off and disconnect vacuum pump from hydraulic reservoir.

STEP 50

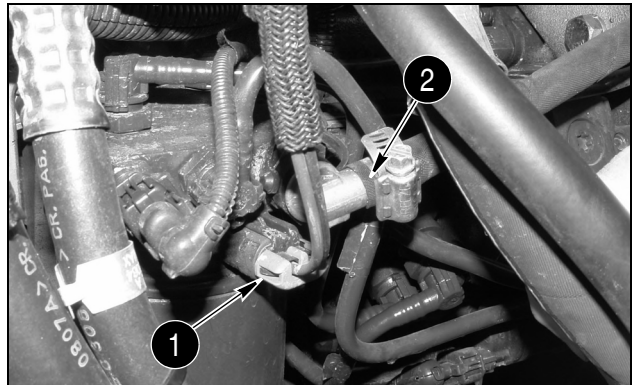

BD07N598-01

Remove cap from fitting and plug from the hose, connect fuel line (2). Connect fuel filter heater wires (1). Remove and discard tag.

STEP 51



BD07N591-01

Remove cap from fitting and plug from the hose, connect fuel line to EDC 7.

STEP 52

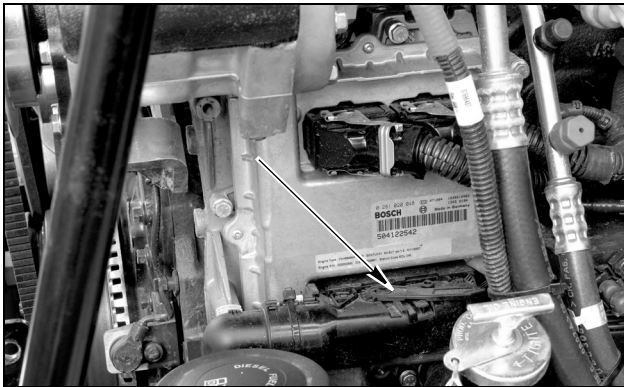

Connect wiring harness to EDC 7 controller.

NOTE: Start the connector on the EDC 7 with lever straight out from EDC 7. Use lever to pull connector into position.

STEP 53

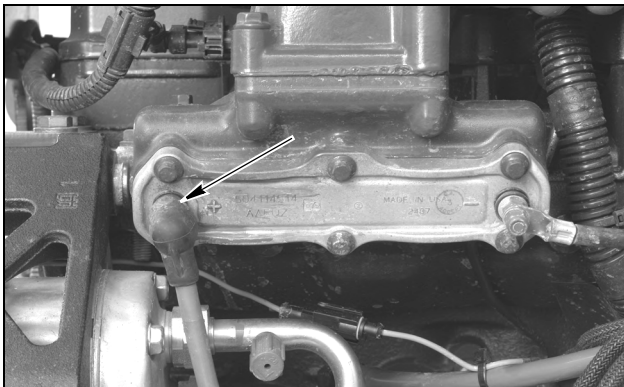

Connect grid heater cable to grid heater. Remove and discard tag.

STEP 54

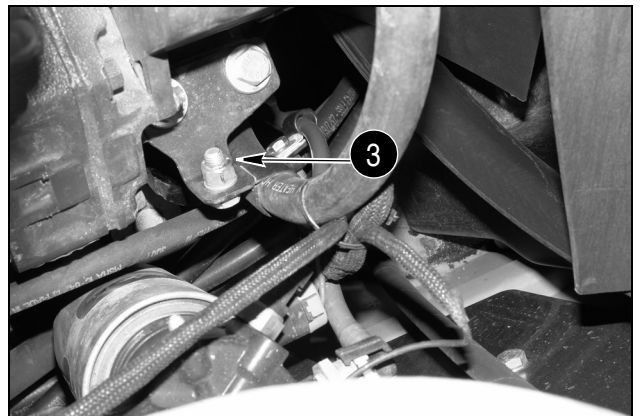
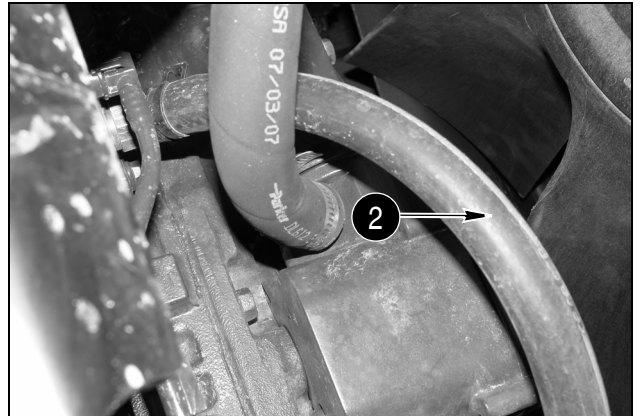
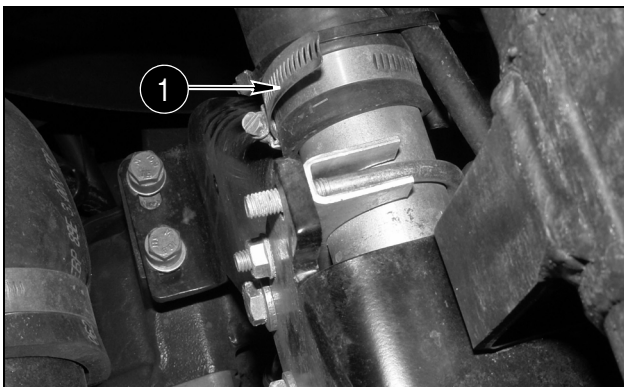

Install the heater hose (2) to the rear of the engine, mount the clamps (3), install the radiator hose (1).

STEP 55

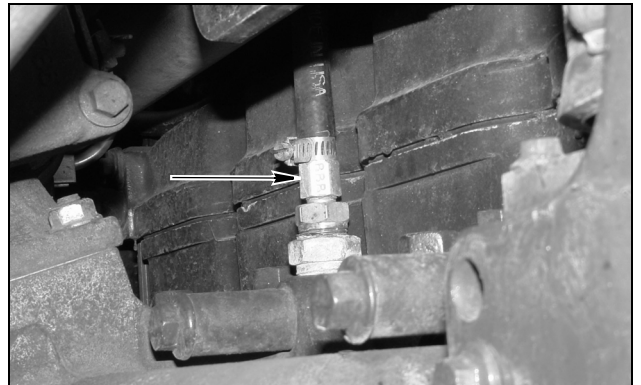

Connect the engine coolant vent hose.

STEP 56

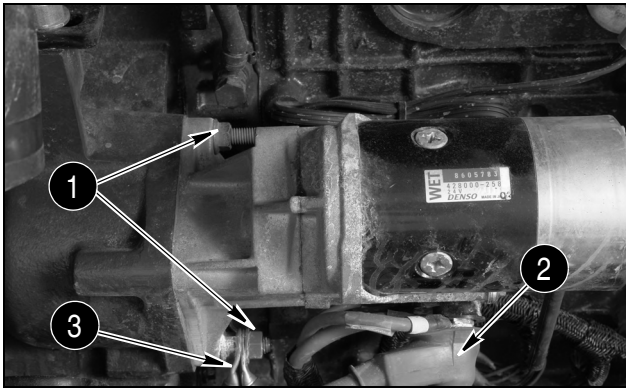

BD07N581-01

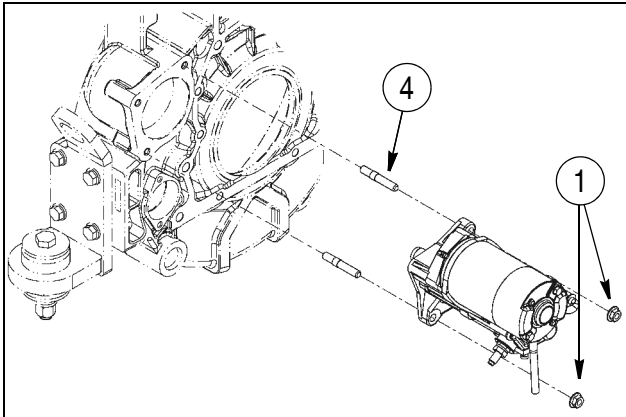

BS08A030

Install the wires (2) to the starter solenoid, install the ground cable and ground strap (3), to the starter. Torque starter mounting nuts (1) to 40 to 50 Nm (29 to 37 pound-feet). Remove and discard tags.

NOTE: If the starter mounting studs (4) have to be replaced apply Loctite 747 primer to studs and holes and apply Loctite 271 to each stud and hole and torque to 19 to 29 Nm (14 to 21 pound-feet).

STEP 57

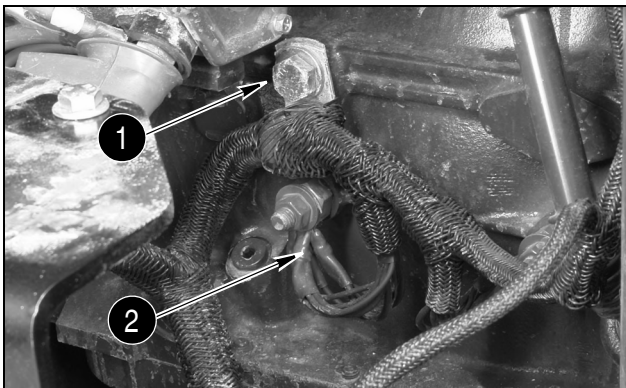

BD07N582-01

Install bolt securing wiring harness (1) clamp to the engine. Install ground wires (2) to the engine.

STEP 58

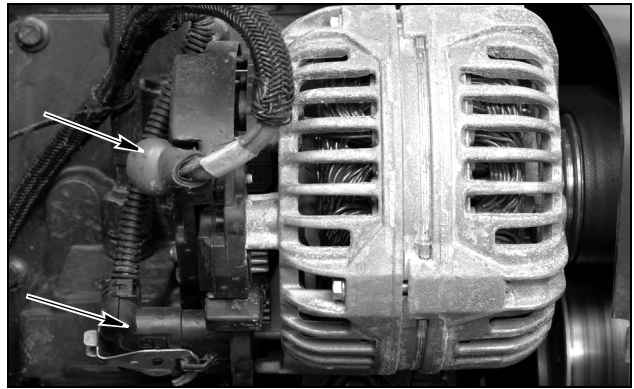

BD07N575-01

Connect the wiring to the alternator. Remove and discard tags.

STEP 59

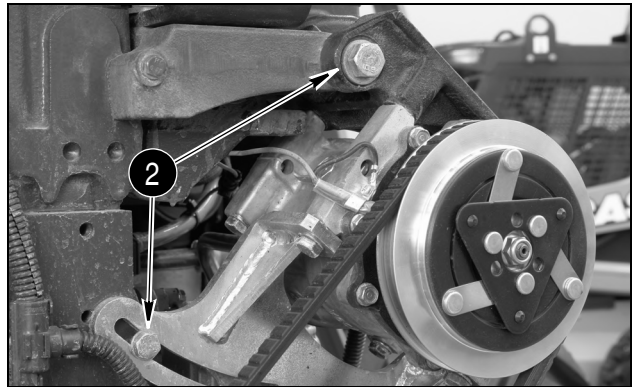

BD07N579-01



W110R395

If loader is equipped with air conditioning, mount the compressor using the two mounting bolts (2), connect the engine wiring harness connectors to air compressor clutch connector (1). Remove and discard tags.

STEP 60

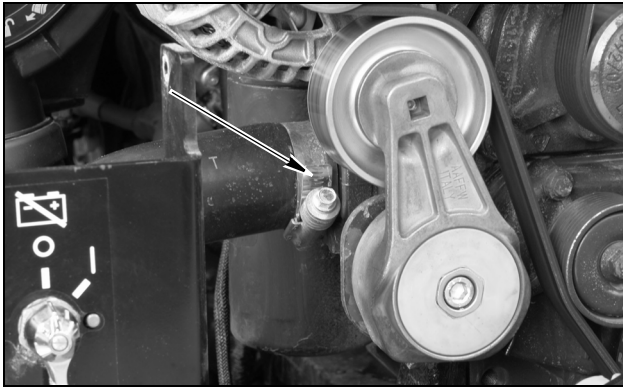

BD07N577-01

Install lower cooler hose to the engine and tighten the clamps to a torque of 10.1 to 11.3 Nm (90 to 100 lb-inch).

STEP 61

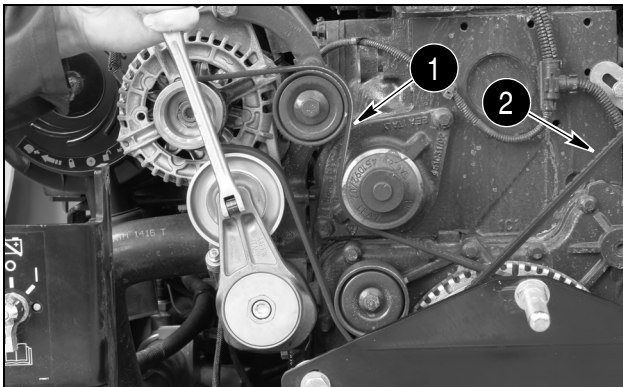

BD07N576-01

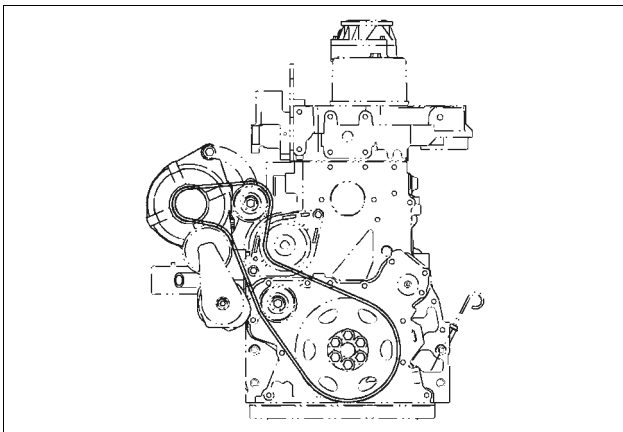

BS08A051

DRIVE BELT ROUTING W/O AC (SEPARATE BELT FOR AC)

Install the drive belt (1) on the pulleys. If equipped with air conditioning install belt (2).

NOTE: A/C compressor belt tension:

- A. Tension for a new belt is 45 Kg (100 lbs.).
- B. Tension for a belt used more than 20 hours is 41 Kg (90 lbs).

STEP 62

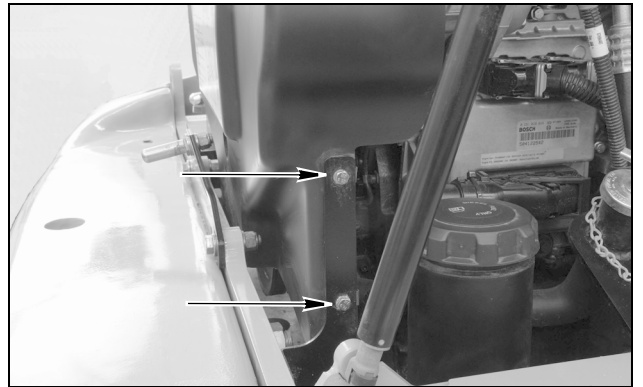

BD07N600-01

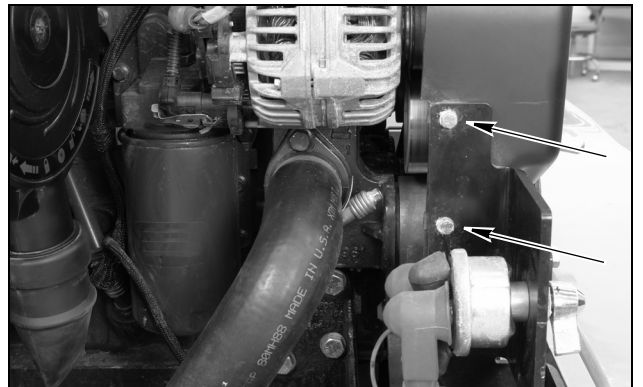

BD07N573-01

Install the cover mounting brackets to the machine frame. Install the belt cover, install the four mounting bolts for the belt cover..

STEP 63

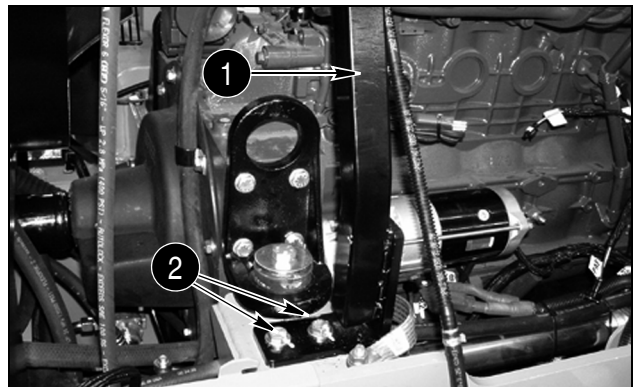

W230R427

Install the support muffer (1), install the four mounting bolts (2, two on each side). Install the support muffer (2).

STEP 64



W110R396

Place the muffler on the brackets. Install the eight mounting bolts (four on each side). Tighten the bolts to a torque of 28.9 to 35.3 Nm (21.3 to 26 lb-ft).

STEP 65

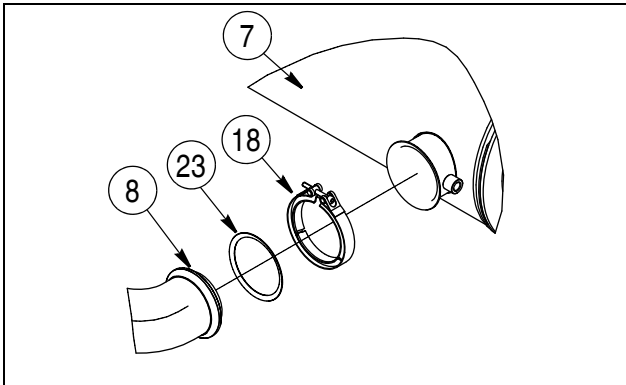

W110R398

NOTE: Position exhaust tube into place using muffer inlet and fixture. So that flexible tube is halfway between fully extended and fully compressed lengths.

Tighten the clamp on the exhaust pipe (8) (torque muffer clamp 6.0 Nm/53 lbs-in).

STEP 66

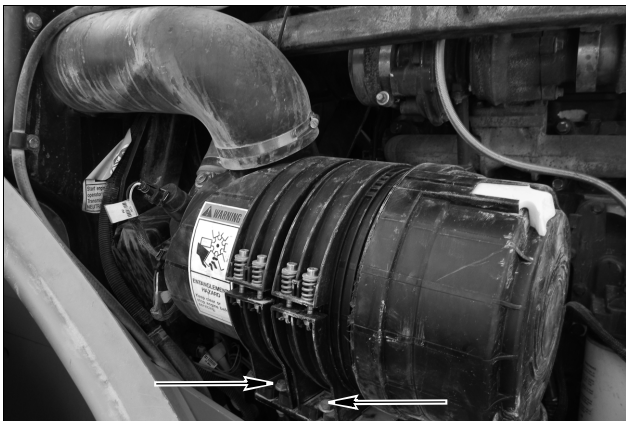

W110R388

Place air cleaner on bracket. Install four mounting bolts in air cleaner and tighten.

STEP 67



W110R392

Install and tighten the exhaust clamp on the turbocharger, tighten the muffler mounting bolts.

STEP 68

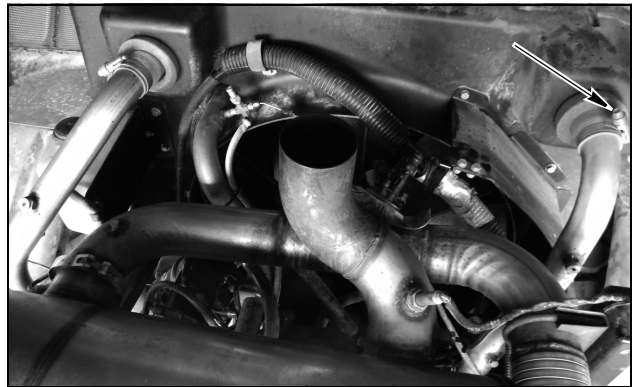

W110R391

Place the after cooler outlet hose on the machine. Tighten the clamp on the after cooler.

STEP 69

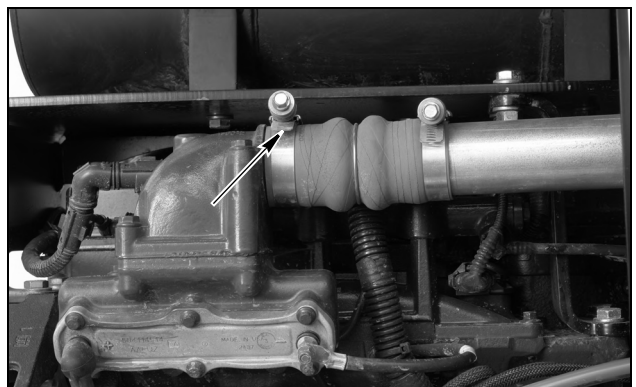

BD07N570-01

Tighten the clamp on the intake manifold for the after cooler output hose.

STEP 70



W110R389

Place the after cooler inlet hose on the machine. Tighten the clamp on the after cooler. Tighten the clamp on the turbocharger for the after cooler inlet hose.

STEP 71



W110R387

Install the intake hose and tighten the clamps on turbocharger and air cleaner.

STEP 72

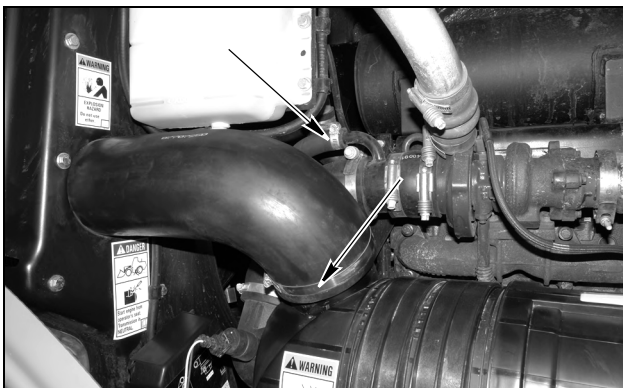

BD07N569-01

Install the crankcase ventilation hose and tighten the clamp on air cleaner intake hose.

STEP 73



W110R387

Connect engine wiring harness connector to air filter restriction switch. Remove and discard tag.

STEP 74



BD03A232

Carefully raise and place hood over loader.

NOTE: Refer to step 8 and 9 of removal for lifting procedure.

STEP 75

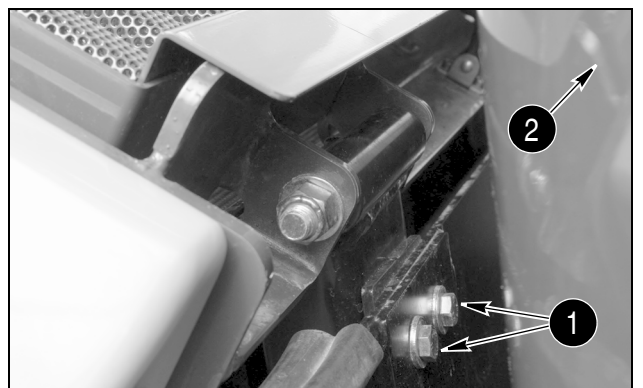

BD07N567-01

Have another person balance the hood. Install the hood hinge mounting bolts (1) to the cooler frame (2) located outside the hood by the cab from the cooler frame. Repeat procedure for the other side.

2000-18

STEP 76

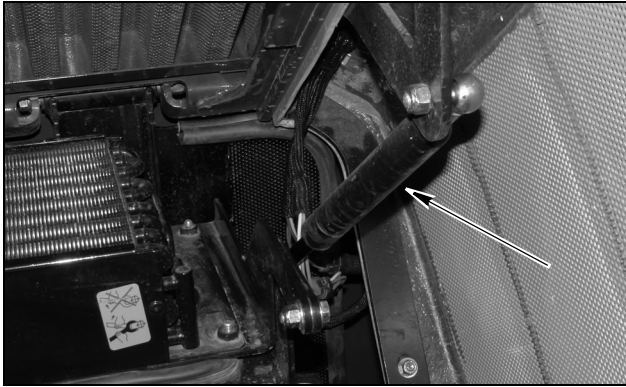

BD07N597-01

Install the right front lift cylinder from the hood. Repeat the procedure for the left hand side.

STEP 77



W110R384

Install the rear lift cylinder on the machine.

STEP 78

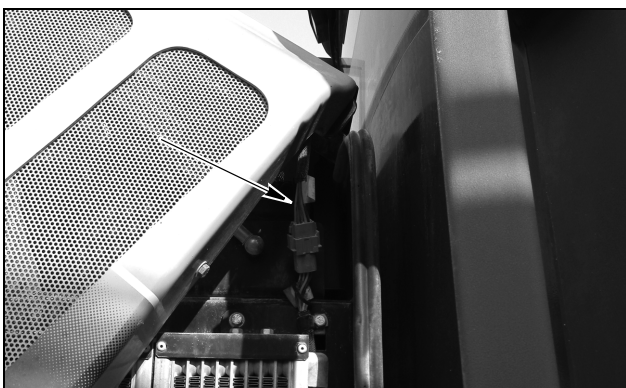

W110R385

Connect hood wiring harness connector and backup alarm connector to the rear chassis wiring harness and remove tags.

STEP 79

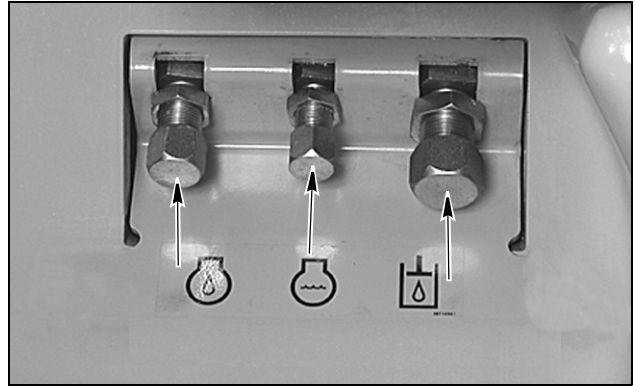

BD02N160

Check and make sure that drain caps are tight.

STEP 80

Install a new oil filter on engine. Fill engine with 11.8 liters (12.5 quarts) of Akcela Unitek CJ-4 engine oil.

STEP 81

If hydraulic reservoir was drained, fill reservoir with 113.6 liters (30.0 gallons) of Akcela Hydraulic excavator fluid.

STEP 82

Fill engine coolant system with a solution of 50% Ethylene Glycol and 50% water. Cooling system capacity is 22 liters (5.8 gallons). Install the radiator cap. Fill the coolant reservoir up to the FULL mark on the reservoir.

STEP 83



BD07N562-01

Connect the batteries, install battery covers, put master disconnect switch in ON position.

STEP 84

Start engine and run the engine at low idle. Run the engine at operating temperature for approximately five minutes to completely mix the Ethylene Glycol and water. When the coolant is at operating temperature, stop the engine. When engine has cooled, check the coolant level at the reservoir.

WARNING: *Hot coolant can spray out if radiator cap is removed. To remove radiator cap: Let system cool, turn to first notch, then wait until all pressure is released. Scalding can result from fast removal of radiator cap.*

STEP 85

Lower the hood.

STEP 86

Put articulation lock in OPERATING position.

RADIATOR

Removal

STEP 1

Park loader on level surface and lower bucket to ground. Apply parking brake and shut down engine.

STEP 2

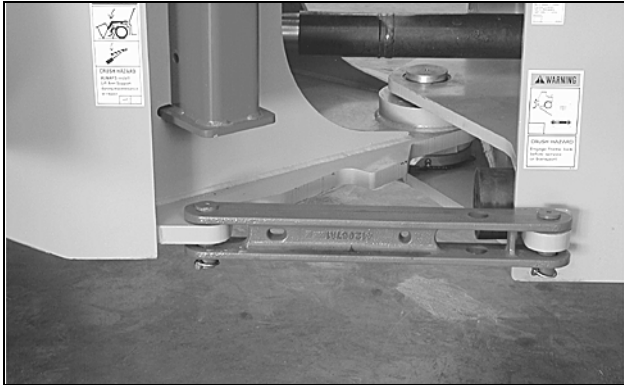

Put articulation lock in LOCKED position.

STEP 3

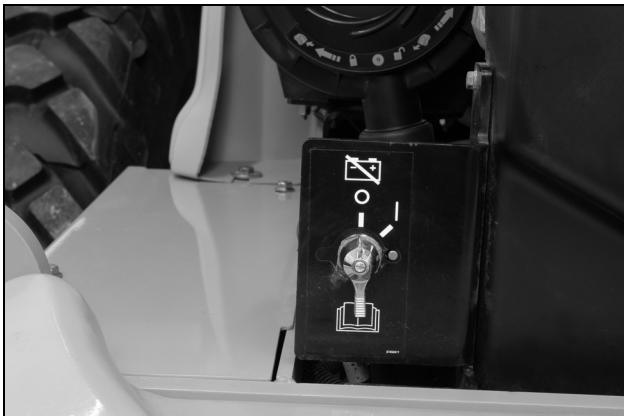

Put master disconnect switch in OFF position.

STEP 4

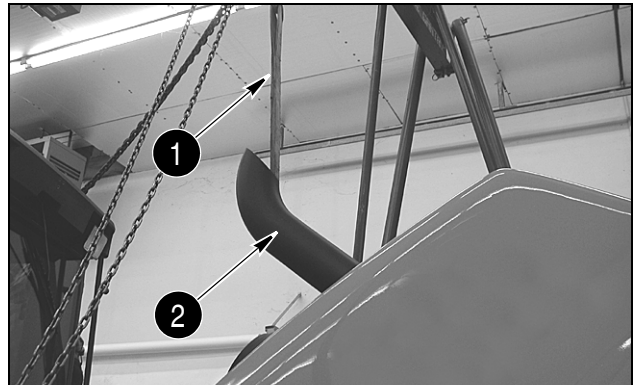

Double up a nylon lifting strap (1) and slide through the exhaust stack (2) on the hood.

STEP 5

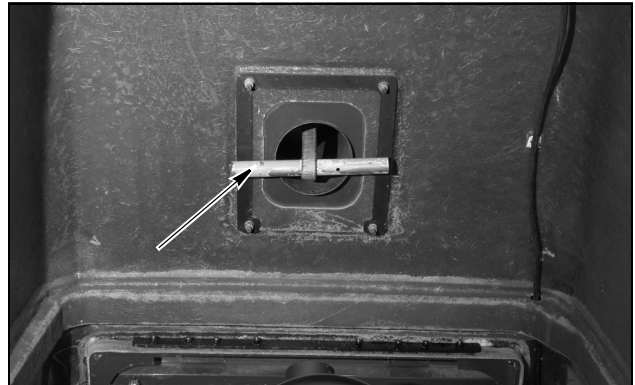

Place a solid steel bar through the strap, raise the hood and release tension on the lifting motor.

STEP 6

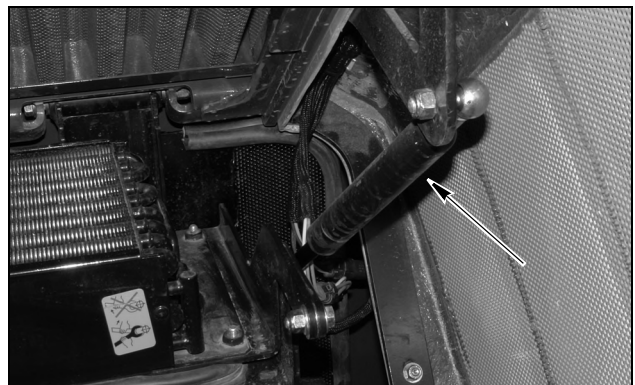

Remove the right front lift cylinder from the hood. Repeat the procedure for the left hand side.

STEP 7



Remove the rear lift cylinder from the machine.

STEP 8

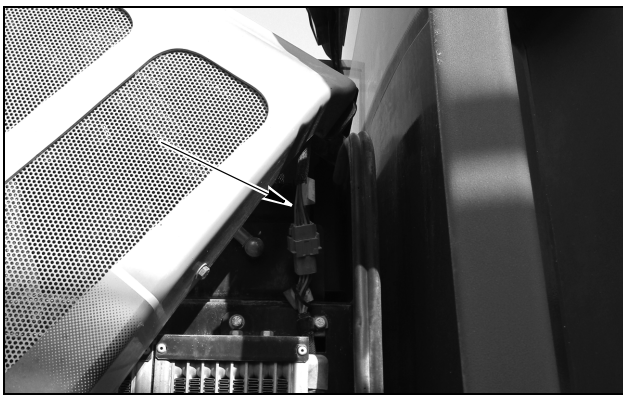

Tag and disconnect hood wiring harness connector and backup alarm connector from rear chassis wiring harness connector.

STEP 9

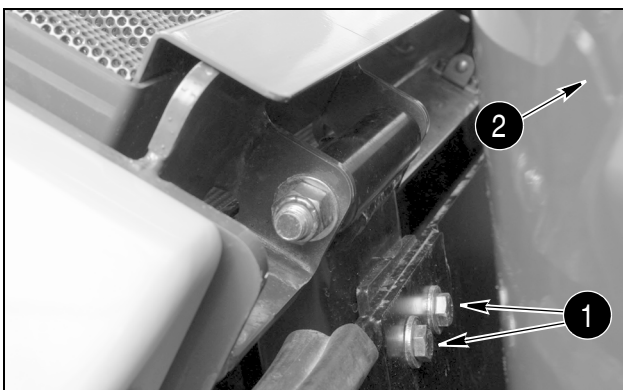

Have another person balance the hood, and remove the hood hinge mounting bolts (1) located outside the hood by the cab (2) from the cooler frame. Repeat procedure for the other side.

STEP 10



Carefully raise and remove hood from loader. Lower hood onto suitable platform and disconnect lifting equipment.

STEP 11

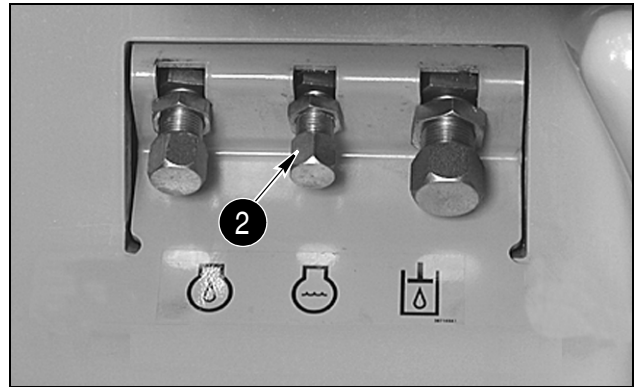

Put a 22.7 liter (6 gallon) container below radiator drain. Remove radiator cap then remove cap and drain coolant into container. Install cap after coolant has drained. Install radiator cap.



Suggest:

If the above button click is invalid.

Please download this document

first, and then click the above link

to download the complete manual.

Thank you so much for reading

2000-22

STEP 12

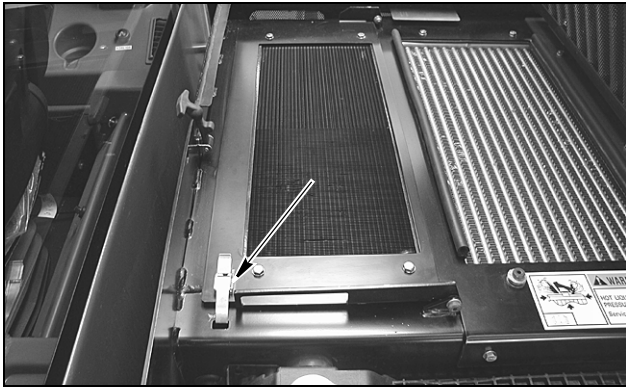

Release catch and tilt air conditioning condenser core up to gain access to upper radiator hose.

STEP 13

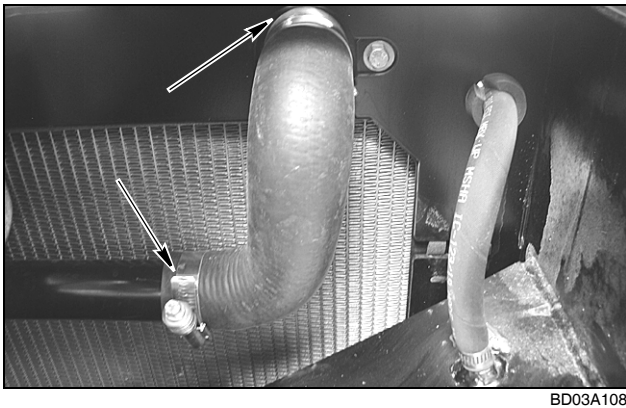

Loosen the upper radiator hose clamps, remove the hose.

STEP 14

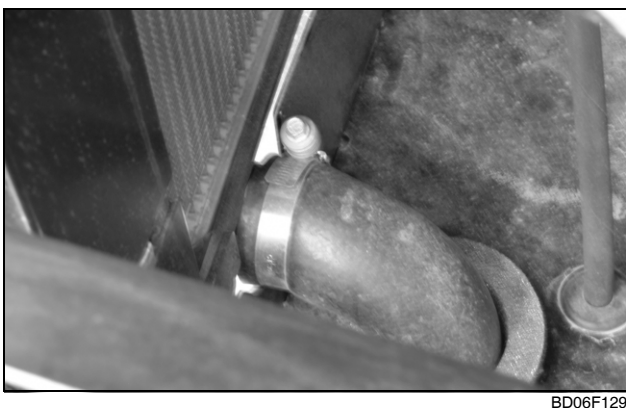

Loose and remove the lower radiator hose from the radiator.

STEP 15



Disconnect overflow hose from radiator. Disconnect connector from coolant level sender.

STEP 16

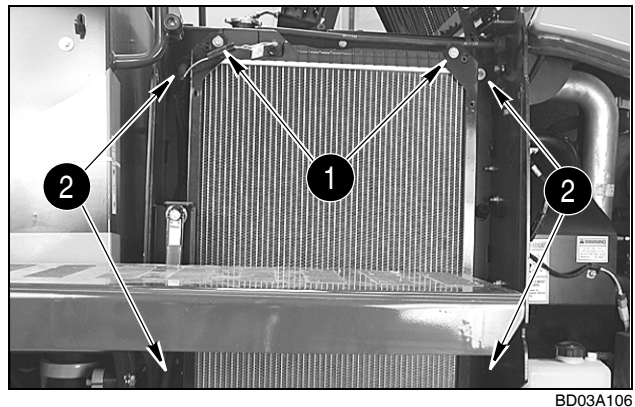

Remove screws and install lifting eyes (1). Attach suitable lifting equipment to lifting eyes. Remove four mounting bolts (2), remove radiator from machine.

<https://www.ebooklibonline.com>

Hello dear friend!

Thank you very much for reading.

Enter the link into your browser.

The full manual is available for immediate download.

<https://www.ebooklibonline.com>