

Page Number	Page Title	Page Reference
01-000-TOC	ENGINE, FUEL AND EXHAUST SYSTEM	01-000-TOC
02-000-TOC	AXLES	02-000-TOC
03-000-TOC	STEERING SYSTEM	03-000-TOC
04-000-TOC	DRIVE TRAIN SYSTEM	04-000-TOC
05-000-TOC	BRAKE SYSTEM	05-000-TOC
06-000-TOC	COMPRESSED AIR SYSTEM	06-000-TOC
07-000-TOC	HYDRAULIC SYSTEM	07-000-TOC
08-000-TOC	ELECTRICAL SYSTEM	08-000-TOC
09-000-TOC	CAB	09-000-TOC
10-000-TOC	AIR CONDITIONING AND HEATING SYSTEM	10-000-TOC
11-000-TOC	CHASSIS	11-000-TOC
12-000-TOC	DECALS	12-000-TOC
13-000-TOC	WHEELS	13-000-TOC
14-000-TOC	IMPLEMENT DRIVE SYSTEM	14-000-TOC
15-000-TOC	IMPLEMENT LIFT SYSTEM FRONT	15-000-TOC
16-000-TOC	IMPLEMENT LIFT SYSTEM REAR	16-000-TOC
17-000-TOC	PRECISION FARMING SYSTEMS	17-000-TOC
18-000-TOC	ATTACHMENTS	18-000-TOC
19-000-TOC	GENERAL INFORMATION	19-000-TOC

Page Number	Page Title	Page Reference
01-0001	CYLINDERBLOCK	21-02
01-0002	FLYWHEEL AND HOUSING	21-04
01-0003	CYLINDER HEAD	21-06
01-0004	VALVE MECHANISM	21-08
01-0005	CRANK MECHANISM	21-10
01-0006	GEAR HOUSING	21-12
01-0007	OIL FILTER	21-14
01-0008	OIL SUMP	21-16
01-0009	AIR CLEANER	21-18
01-0010	INTAKE- AND EXHAUST PIPE	21-20
01-0011	INTERCOOLER	21-22
01-0012	TURBOCHARGER	21-24
01-0013	MUFFLER	21-26
01-0014	FUEL FILTER	22-02
01-0015	FUEL PIPES	22-04
01-0016	INJECTION PUMP	22-06
01-0017	SPEED LEVERS	22-08
01-0018	RADIATOR	23-02
01-0019	COOLANT PUMP	23-04
01-0020	STARTERMOTOR	24-02
01-0021	ALTERNATOR	24-04
01-0022	EEM PARTS	24-06
01-0023	GASKET SETS	28-02
01-0024	GASKET SETS	28-04
01-0025	ENGINE REPAIR KIT AND BEARING	28-06
01-0026	ADJUSTING PLATE FOR INJECTOR	28-08
01-0027	AIR INLET, TAKEN UP (OPTIONAL EQUIPMENT) -2004	29-10
01-0028	AIR INLET, TAKEN UP (OPTIONAL EQUIPMENT) 2005-	29-10A
01-0029	ENGINE HEATER (OPTIONAL EQUIPMENT)	29-12
01-0030	PILLAR EXHAUST PIPE (OPTIONAL EQUIPMENT)	29-14

T130CH TRACTOR (TC,TCH SERIES)
 SPIMG-013-21-02

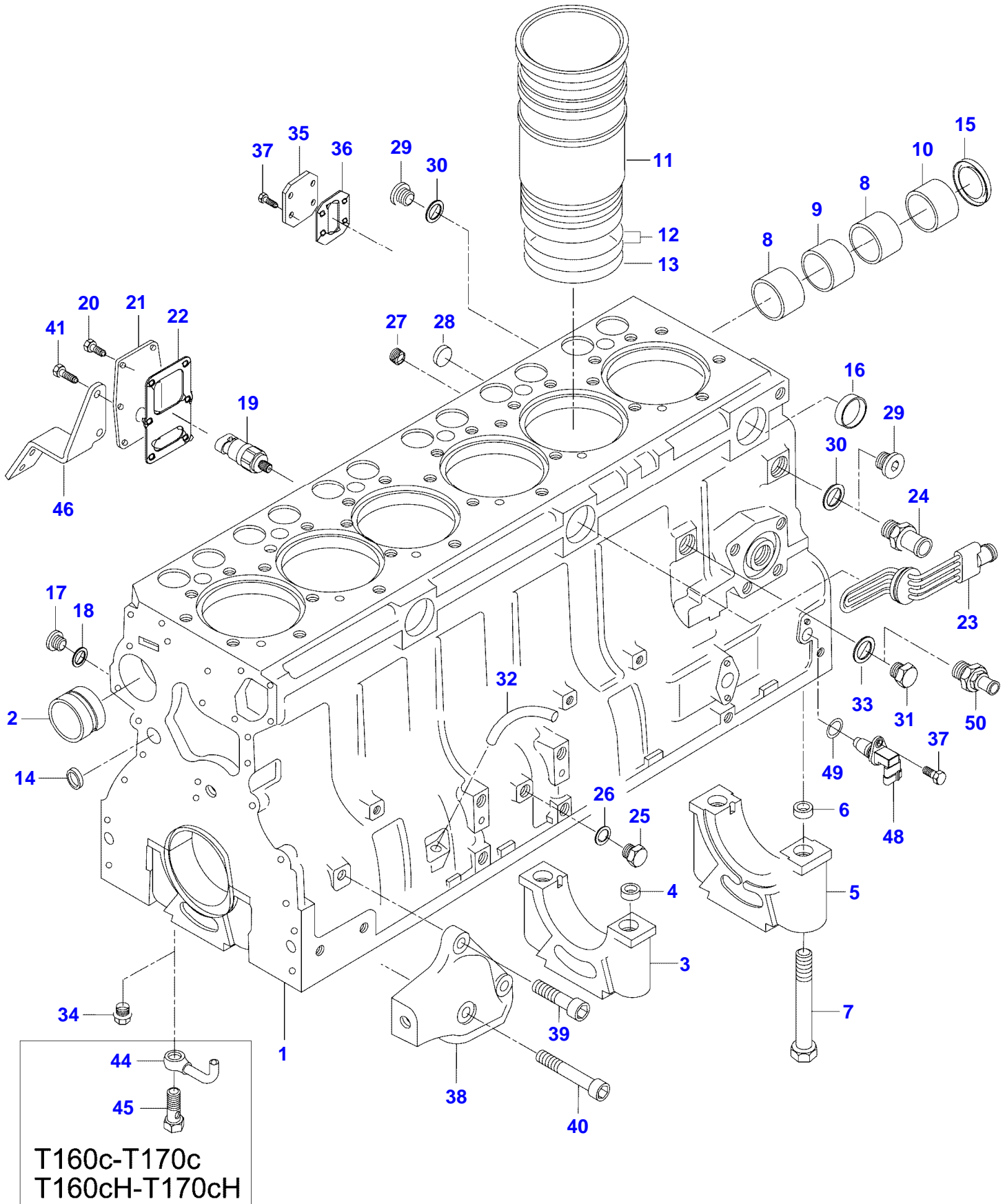

<https://www.ebooklibonline.com>

Hello dear friend!

Thank you very much for reading.

Enter the link into your browser.

The full manual is available for immediate download.

<https://www.ebooklibonline.com>

Item	Part Number	Qty	Description Comments
1	V836866110	1	CYLINDER BLOCK
2	V836866069	1	CAMSHAFT BEARING BUSHING
3	NS	6	NON-SERVICEABLE PART
4	V836214478	12	BEARING COVER GUIDE SLEEVE
5	NS	1	NON-SERVICEABLE PART
6	V836214478	2	BEARING COVER GUIDE SLEEVE
7	V835329030	14	HEX CAP SCREW
8	V836852460	2	CAMSHAFT BEARING BUSHING
9	V836852459	1	CAMSHAFT BEARING BUSHING
10	V836852461	1	CAMSHAFT BEARING BUSHING
11	V836666990	6	LINER
12	V836647502	12	CYLINDER LINER O-RING S2
13	V836647503	6	CYLINDER LINER O-RING S2
14	V640016016	4	CUP PLUG S2
15	V836852744	1	PLUG
16	V640016040	2	CUP PLUG
17	V640325110	3	SCREW PLUG
18	V615571014	3	SEALING WASHER S2
19	V836866613	1	SENSOR
20	V528801380	4	HEX CAP SCREW M8 X 20
21	V836847994	1	FLANGE
22	V836322852	1	GASKET S2
23	V836847596	1	ENGINE BLOCK HEATER 1100 W
25	V640045112	1	PLUG
26	V615881216	1	SEALING WASHER S2
27	V640025010	1	PLUG
28	V640016018	3	CUP PLUG
29	V640325018	2	PLUG
30	V615881822	2	SEALING WASHER S2
31	V836019756	1	PLUG
50	V836664377	1	DRAIN VALVE
32	V836129747	1	OIL DIPSTICK GUIDE PIPE
33	V615881824	1	SEALING WASHER S2
34	V640045112	6	PLUG
35	V836866957	1	COVER
36	V836866958	1	GASKET
37	V528801362	4	HEX CAP SCREW M8 X 16
38	V836346012	1	ENGINE MOUNT LEFT
	V836346013	1	ENGINE MOUNT RIGHT
39	V581705850	4	HEX SOCKET SCREW M14 X 40

Item	Part Number	Qty	Description Comments
40	V581705890	2	HEX SOCKET SCREW M14 X 60
41	V528801400	2	HEX CAP SCREW M8 X 25
46	V836866872	1	SUPPORT
48	V836866392	1	SPEED SENSOR
49	V614601524	1	O-RING
	V836840237	1	ENGINE GASKET KIT S1
	V836840238	1	ENGINE GASKET KIT S1+S2

T130CH TRACTOR (TC,TCH SERIES)
SPIMG-013-21-04

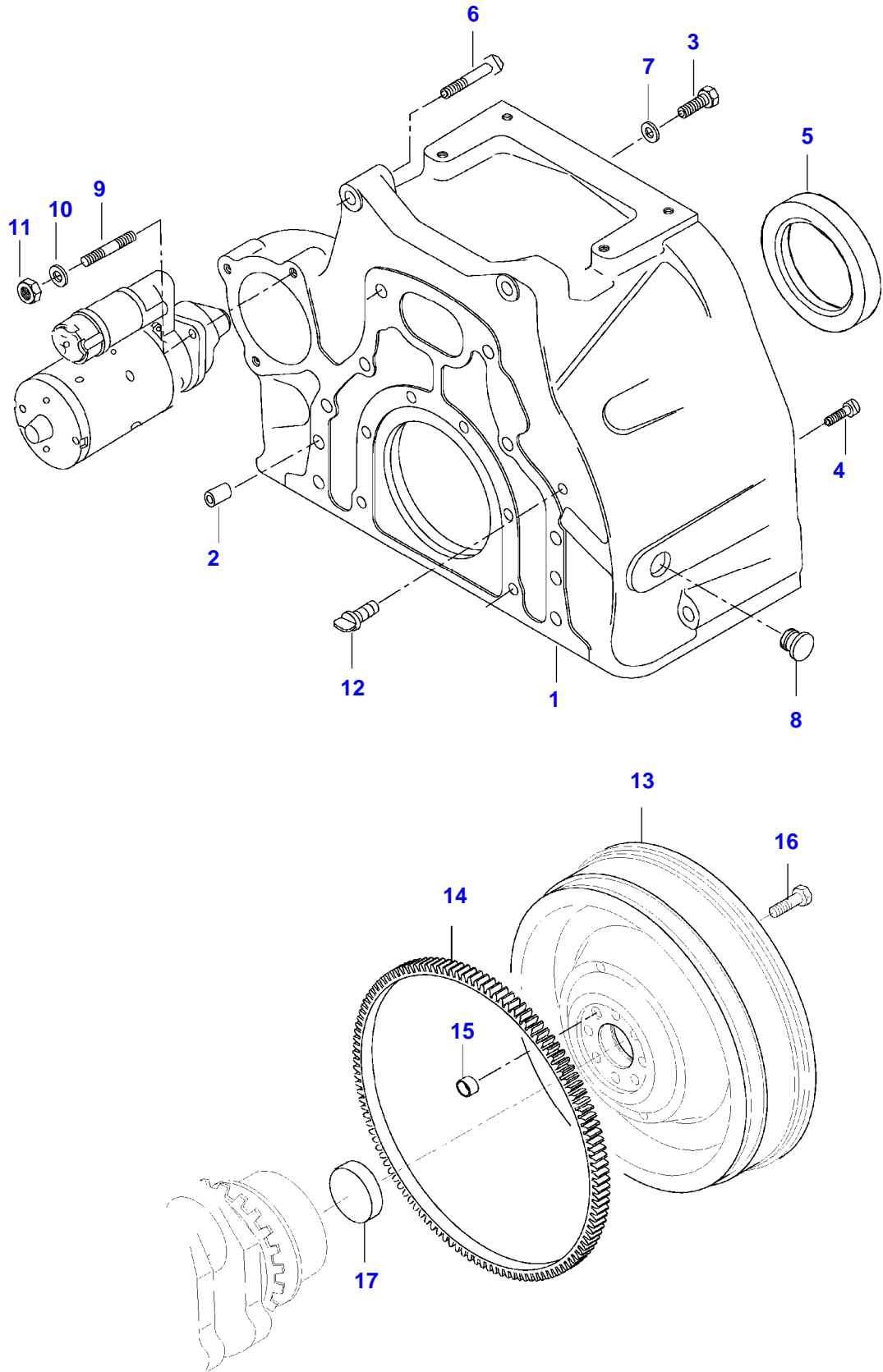

Item	Part Number	Qty	Description Comments
1	V836666482	1	FLYWHEEL HOUSING
2	V598359850	2	PIN
3	V528702220	8	HEX CAP SCREW M12 X 35
4	V581705030	6	HEX SOCKET SCREW M10 X 30
5	V614500002	1	CRANKSHAFT SEAL S2
6	V581705490	2	HEX SOCKET SCREW M12 X 60
7	V500951200	8	SPRING WASHER
8	V836007572	1	RUBBER PLUG
9	V546801800	3	STUD BOLT M10 X 25
10	V500951000	3	SPRING WASHER
11	V504601000	3	NUT M10
12	V836859311	1	PLUG
13	V836859824	1	FLYWHEEL
14	V835328783	1	STARTER RING
15	V836659527	1	GUIDE SLEEVE
16	V528702230	8	HEX CAP SCREW 150NM
17	V836852082	1	PLUG

T130CH TRACTOR (TC,TCH SERIES)
SPIMG-013-21-06

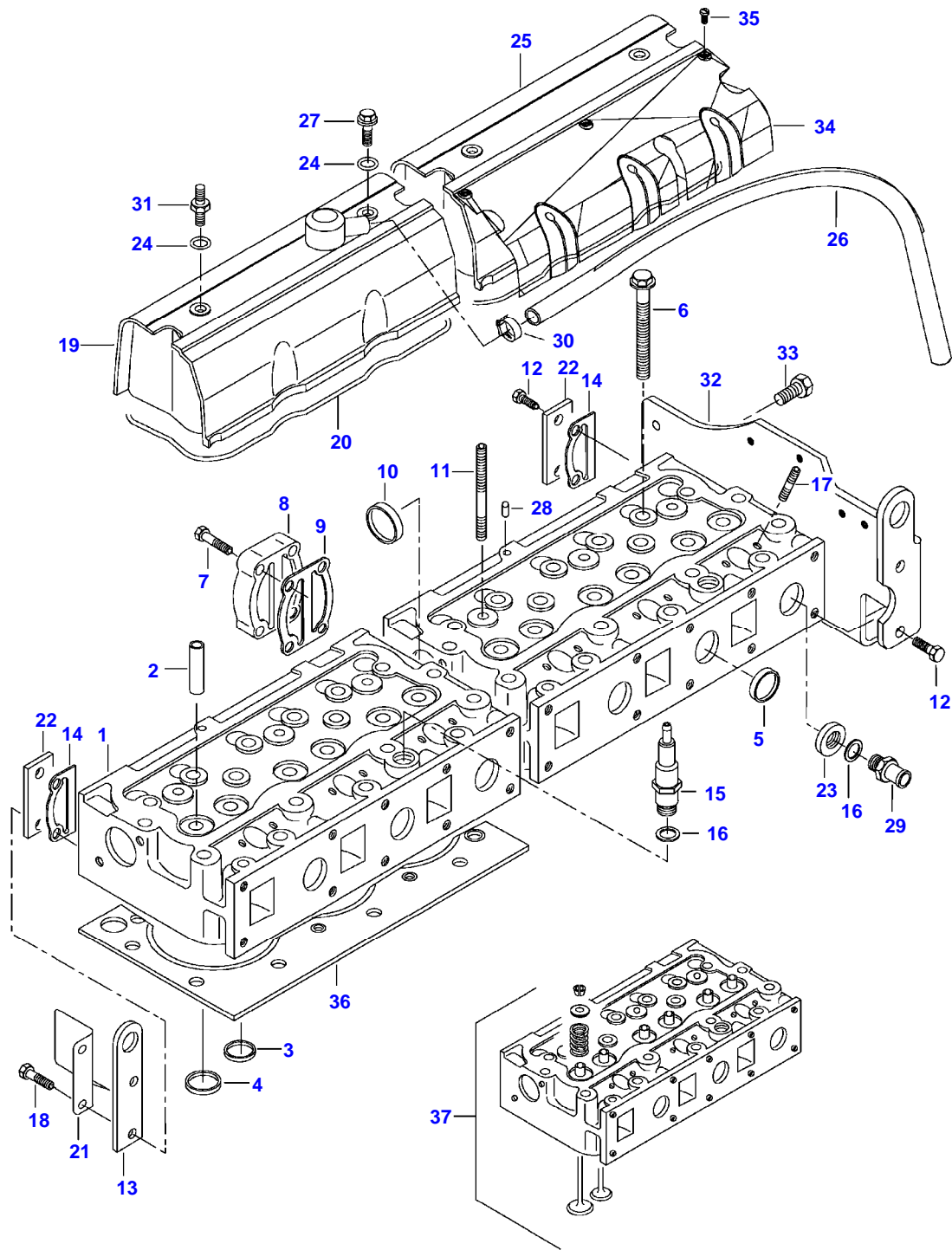

Item	Part Number	Qty	Description Comments
1	NS	2	NON-SERVICEABLE PART CYLINDER HEAD
2	V836673175	12	VALVE GUIDE
3	V836647600	6	VALVE SEAT
5	V836647942	10	EXHAUST CUP PLUG
6	V836859104	34	HEXAGON FLANGE BOLT
7	V528801830	4	HEX CAP SCREW M10 X 40
8	V836855348	1	CONNECTION FLANGE
9	V836867390	1	GASKET S1
10	V640016045	1	CUP PLUG
11	V546801900	4	STUD BOLT M10 X 75
12	V528801800	4	HEX CAP SCREW M10 X 25
13	V836855349	2	LIFT EYE
14	V836867391	2	GASKET S1
15	V836666989	1	HOSE COUPLER
16	V615881822	2	SEALING WASHER S1
17	V546901435	12	STUD BOLT
18	V528801820	2	HEX CAP SCREW M10 X 35
19	V836667206	1	VALVE COVER
20	V836667243	2	VALVE ROCKER COVER GASKET S1
21	V836666199	1	HEAT SHIELD
22	V836855350	2	BLOCK OFF PLATE
23	V836667103	1	UNION
24	V614901030	4	O-RING S1
26	V836755007	1	RUBBER HOSE
27	V540801780	3	HEXAGON FLANGE BOLT M10 X 20
28	V595959140	2	PIN
29	V836119837	1	HOSE COUPLER
30	V602088532	1	HOSE CLIP
31	V836667033	1	STUD BOLT
32	V836767031	1	SUPPORT
33	V528803010	1	HEX CAP SCREW M16 X 30
35	V572503362	6	SCREW M5 X 10
36	V836666302	2	CYLINDER HEAD GASKET S1
37	V836873284	1	CYLINDER HEAD FRONT
	V836873285	1	CYLINDER HEAD REAR

T130CH TRACTOR (TC,TCH SERIES)
SPIMG-013-21-08

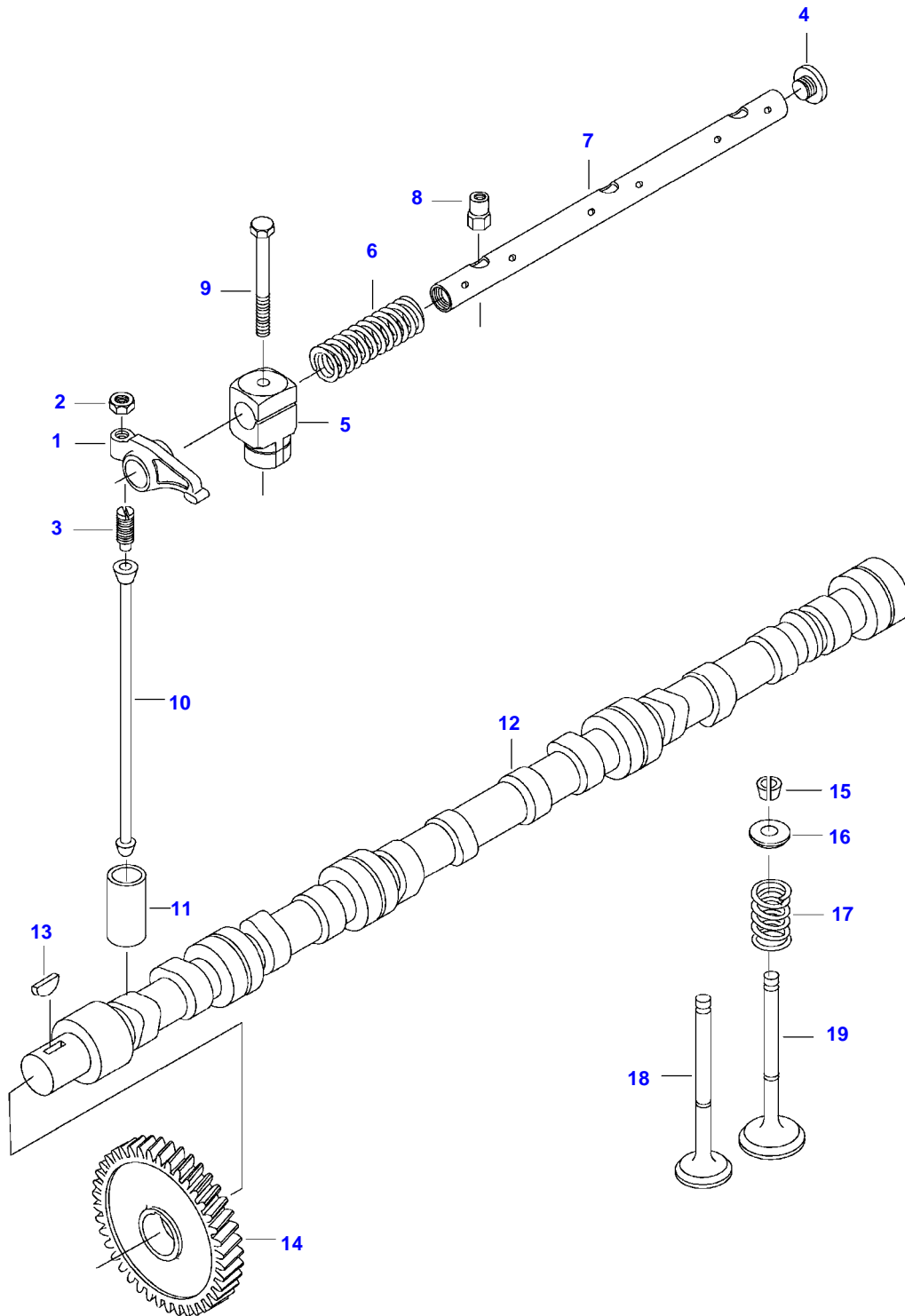

Item	Part Number	Qty	Description Comments
	V836667043	2	ROCKER SHAFT ASM ASSEMBLY
1	V836666608	12	ROCKER ARM . -S12222 (M)
	V836667042	12	ROCKER ARM . S12223- (M)
2	V512861000	12	NUT ..
3	V836655866	12	ADJUSTING SCREW .. -S12222 (M)
	V837069023	12	VALVE ROCKER ADJUSTMENT SCREW .. S12223- (M)
4	V836655899	4	PLUG . -S12222 (M)
	V837069020	4	PLUG . S12223- (M)
5	V836666609	6	BRACKET .
6	V836655884	4	SPRING .
7	V836655870	2	SHAFT .
8	V836655406	4	SLEEVE NUT .
9	V529801910	2	HEX CAP SCREW M10 X 80
10	V836655867	12	PUSHROD
11	V836014264	12	TAPPET
12	V836866054	1	CAMSHAFT
13	V603305760	1	WOODRUFF KEY
14	V836646389	1	GEAR,CAMSHAFT
15	V836646382	24	COTTER
16	V836646381	12	WASHER
17	V836646380	12	SPRING
18	V836646357	6	EXHAUST VALVE
19	V836646356	6	INTAKE VALVE

T130CH TRACTOR (TC,TCH SERIES)
SPIMG-013-21-10

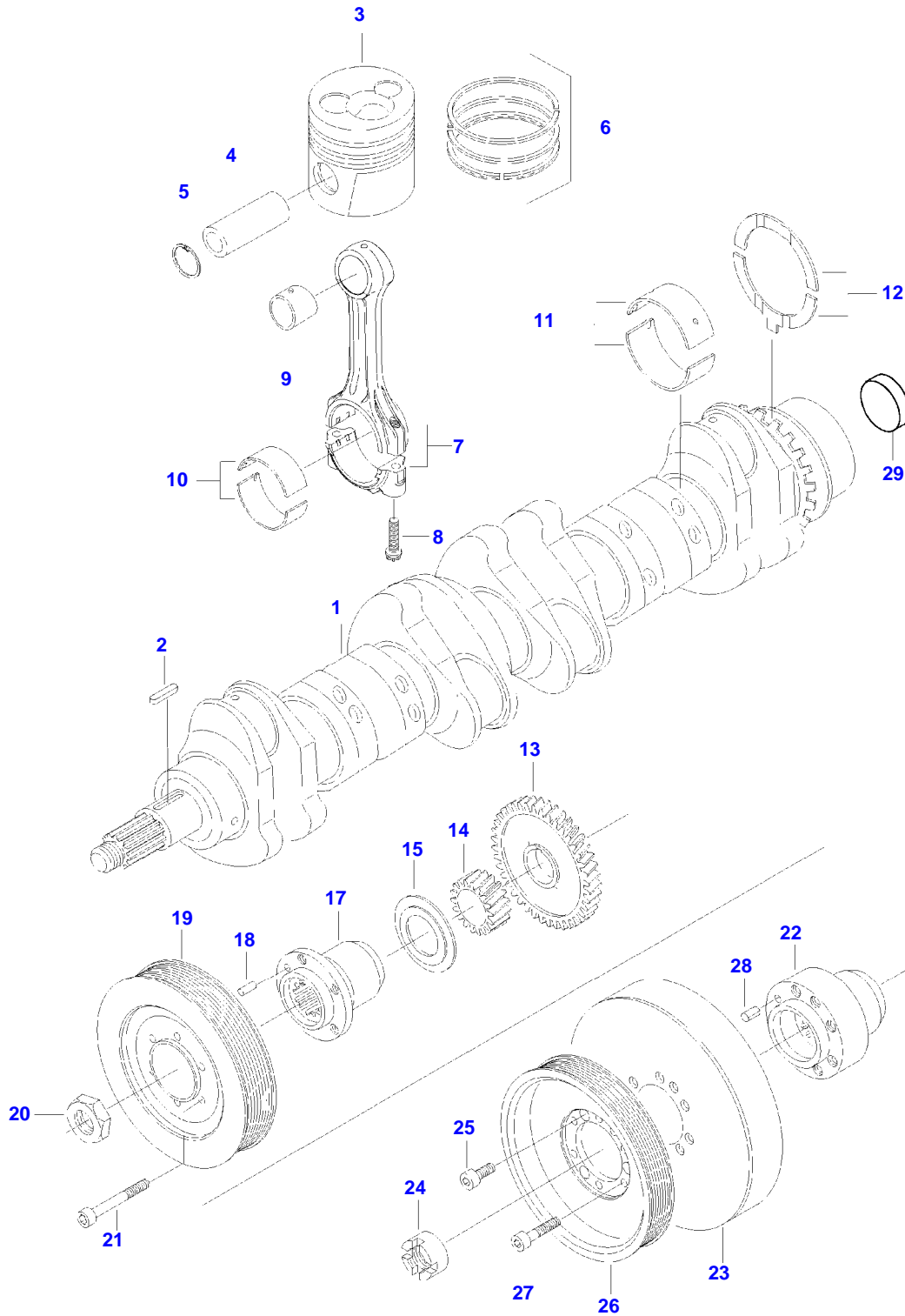

Item	Part Number	Qty	Description Comments	Technical Specification
1	V836866474	1	CRANKSHAFT	
2	V603345110	1	KEY	
3	V836659702	6	PISTON	
4	NS	6	NON-SERVICEABLE PART	
			PISTON PIN	
5	NS	12	NON-SERVICEABLE PART	
			CIRCLIP	
6	V836640126	6	PISTON RING KIT	
			NON-SERVICEABLE PART	
4	NS	6	NON-SERVICEABLE PART	
			PISTON PIN	
5	NS	12	NON-SERVICEABLE PART	
			CIRCLIP	
4	NS	6	NON-SERVICEABLE PART	
			PISTON PIN	
5	NS	12	NON-SERVICEABLE PART	
			CIRCLIP	
	V836840928	1	CONNECTING ROD KIT REF. 7, 8, 9	
7	NS	6	NON-SERVICEABLE PART	
			CONNECTING ROD 1935-1954 G	
			F	
	NS	6	NON-SERVICEABLE PART	
			CONNECTING ROD 1955-1974 G	
			V	
	NS	6	NON-SERVICEABLE PART	
			CONNECTING ROD 1975-1994 G	
			X	
	NS	6	NON-SERVICEABLE PART	
			CONNECTING ROD 1995-2014 G	
			Y	
	NS	6	NON-SERVICEABLE PART	
			CONNECTING ROD 2015-2034 G	
			W	
	NS	6	NON-SERVICEABLE PART	
			CONNECTING ROD 2035-2054 G	
			Z	
	NS	6	NON-SERVICEABLE PART	
			CONNECTING ROD 2055-2074 G	
			G	
8	V836864141	12	CONNECTING ROD BOLT	
			BEARING BUSH	STD
9	V836110646	6	BEARING BUSH	
			BEARING SHELL	
10	V836110552	6	SEE PAGE 01-0025	

Item	Part Number	Qty	Description Comments	Technical Specification
11	V836655514	7	MAIN BEARING SEE PAGE 01-0025	
12	V836119459	2	THRUST WASHER SEE PAGE 01-0025	
13	V836119550	1	GEAR,CRANKSHAFT	
14	V836122840	1	GEAR,CRANKSHAFT	
15	V836129781	1	RING	
17	V836846463	1	CRANKSHAFT HUB	
18	V595953360	1	PIN	
19	V836866625	1	PULLEY	
20	V836647310	1	CRANKSHAFT NUT	
21	V581804670	6	HEX SOCKET SCREW M8 X 50	
29	V836852082	1	PLUG	

T130CH TRACTOR (TC,TCH SERIES)
SPIMG-013-21-12

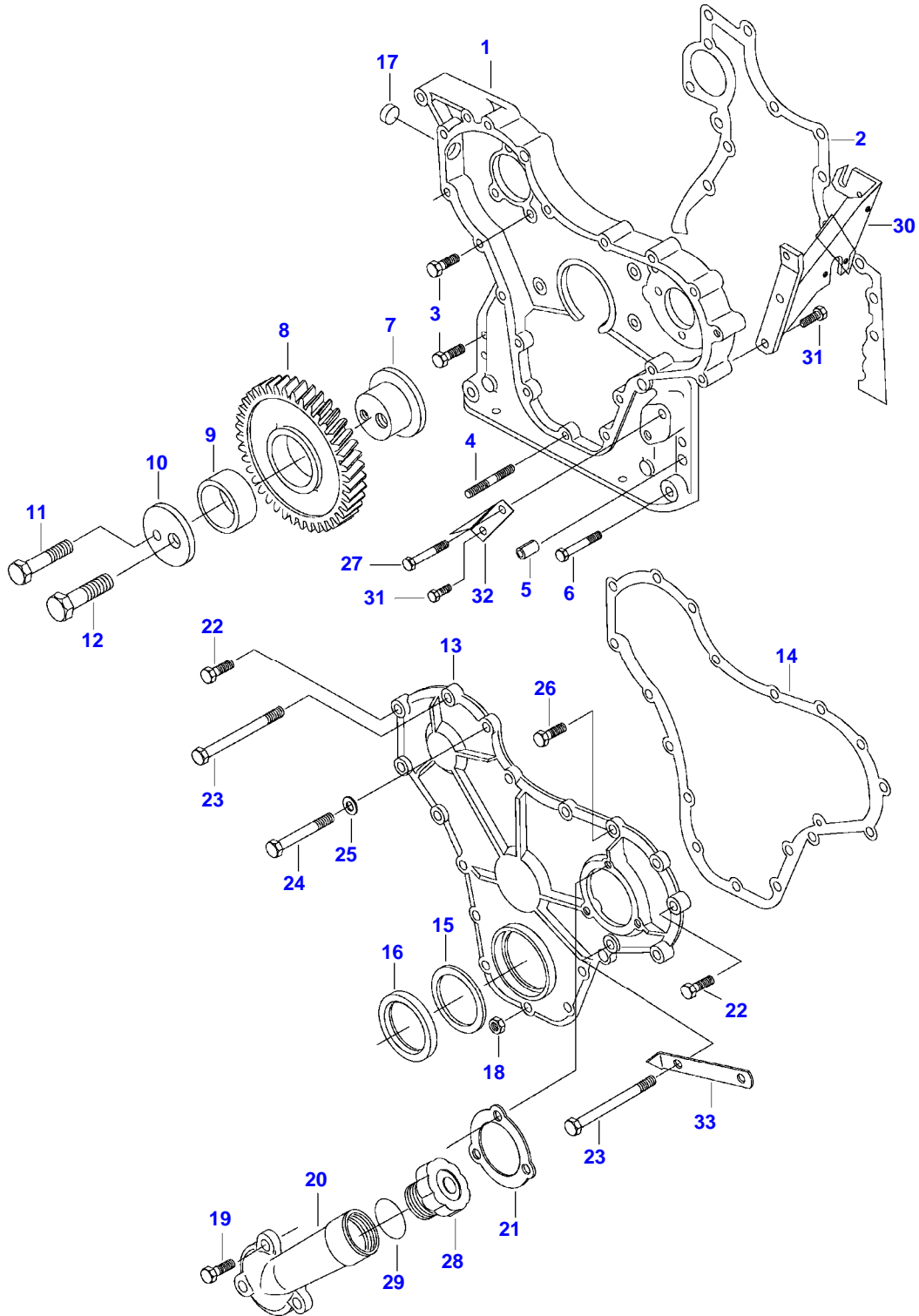

Item	Part Number	Qty	Description Comments	Technical Specification
1	V836666400	1	TIMING GEAR CASE -S9538 (M)	
	V836667947	1	TIMING GEAR CASE S9539- (M)	
2	V836647419	1	GASKET S2 -S9538 (M)	
	VUK0182	1	GASKET SEALPASTE S9539- (M)	250ML
3	V528801400	9	HEX CAP SCREW M8 X 25	
4	V546801380	5	STUD BOLT M8 X 20	
5	V598359850	4	PIN	
6	V529801440	2	HEX CAP SCREW M8 X 45	
7	V836129709	1	SHAFT	
8	V836129863	1	IDLER GEAR	
9	V836129844	1	BEARING BUSH	
10	V836129845	1	FLANGE	
11	V528801860	1	HEX CAP SCREW M10 X 55	
12	V529902680	1	HEX CAP SCREW M14 X 65	
13	V836647572	1	GEAR HOUSING FRONT COVER	
14	V836129942	1	GASKET S2 -S9538 (M)	
	VUK0182	1	GASKET SEALPASTE S9539- (M)	250ML
15	V836129782	1	COVER	
16	V614105880	1	OIL SEAL S2	
17	V640016016	1	CUP PLUG	
18	V504800800	5	NUT M8	
19	V528801380	3	HEX CAP SCREW M8 X 20	
20	V836746921	1	PIPE	
21	V836129946	1	GASKET S2	
22	V528801420	3	HEX CAP SCREW M8 X 35	
23	V529801500	2	HEX CAP SCREW M8 X 75	
24	V529801470	3	HEX CAP SCREW M8 X 60	
25	V836120989	1	WASHER	
26	V528801400	2	HEX CAP SCREW M8 X 25	
27	V529801450	1	HEX CAP SCREW M8 X 50	
28	V836338733	1	OIL FILLER CAP	
29	V614604740	1	O-RING	
30	V836664528	1	THROTTLE SENSOR BRACKET	
31	V528801362	3	HEX CAP SCREW M8 X 16	
32	V836652318	1	TIMING MARK INDICATOR	

T130CH TRACTOR (TC,TCH SERIES)
SPIMG-013-21-14

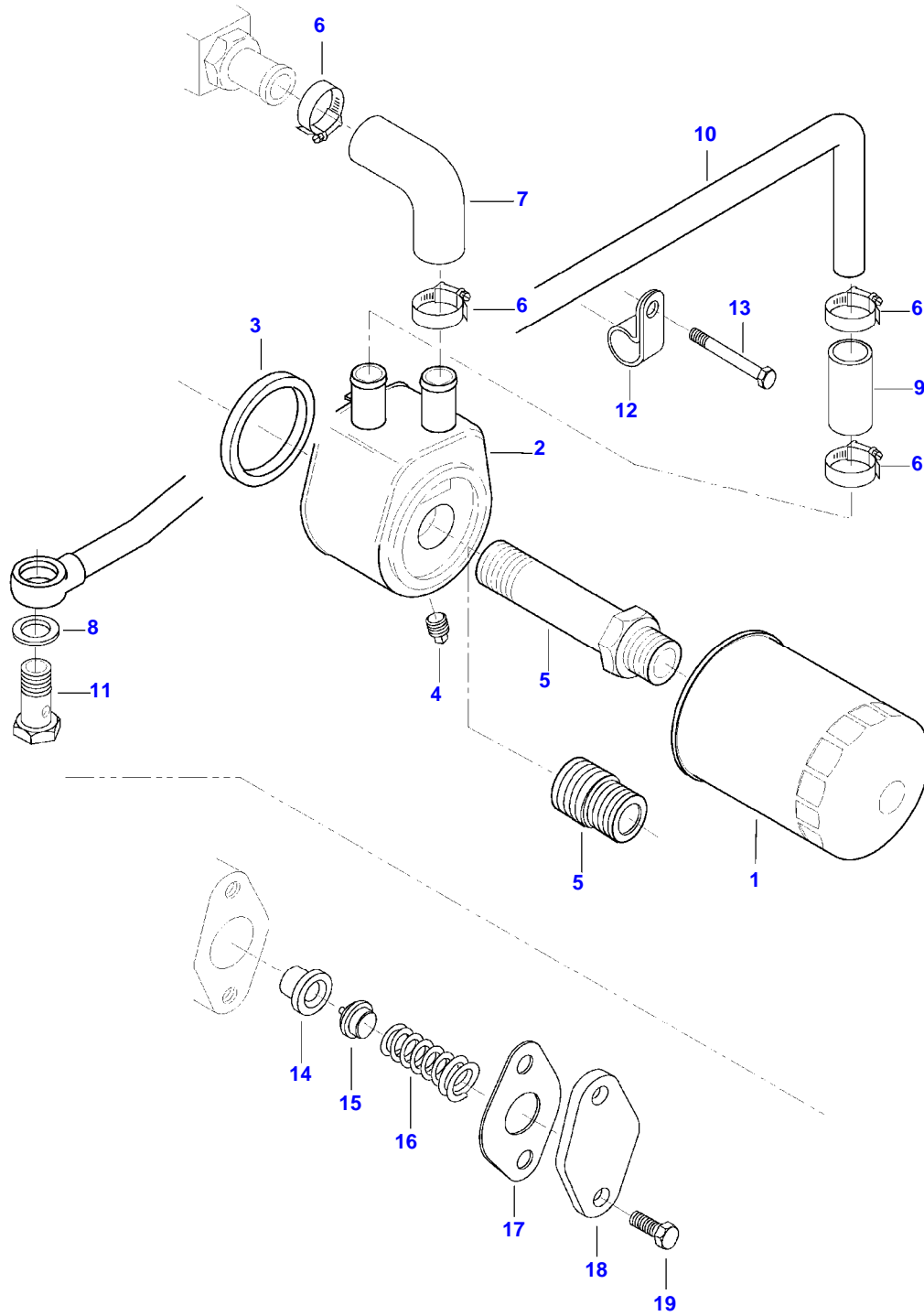

Item	Part Number	Qty	Description Comments
1	V836662580	1	ENGINE OIL FILTER
5	V836647404	1	UNION
14	V836659521	1	VALVE SEAT
			.
15	V836659522	1	VALVE CONE
			.
16	V836659523	1	SPRING
			.
17	V836322190	1	GASKET
			.
			S2
18	V836659524	1	COVER
			.
19	V528801380	2	HEX CAP SCREW
			.
			M8 X 20

T130CH TRACTOR (TC,TCH SERIES)
SPIMG-013-21-16

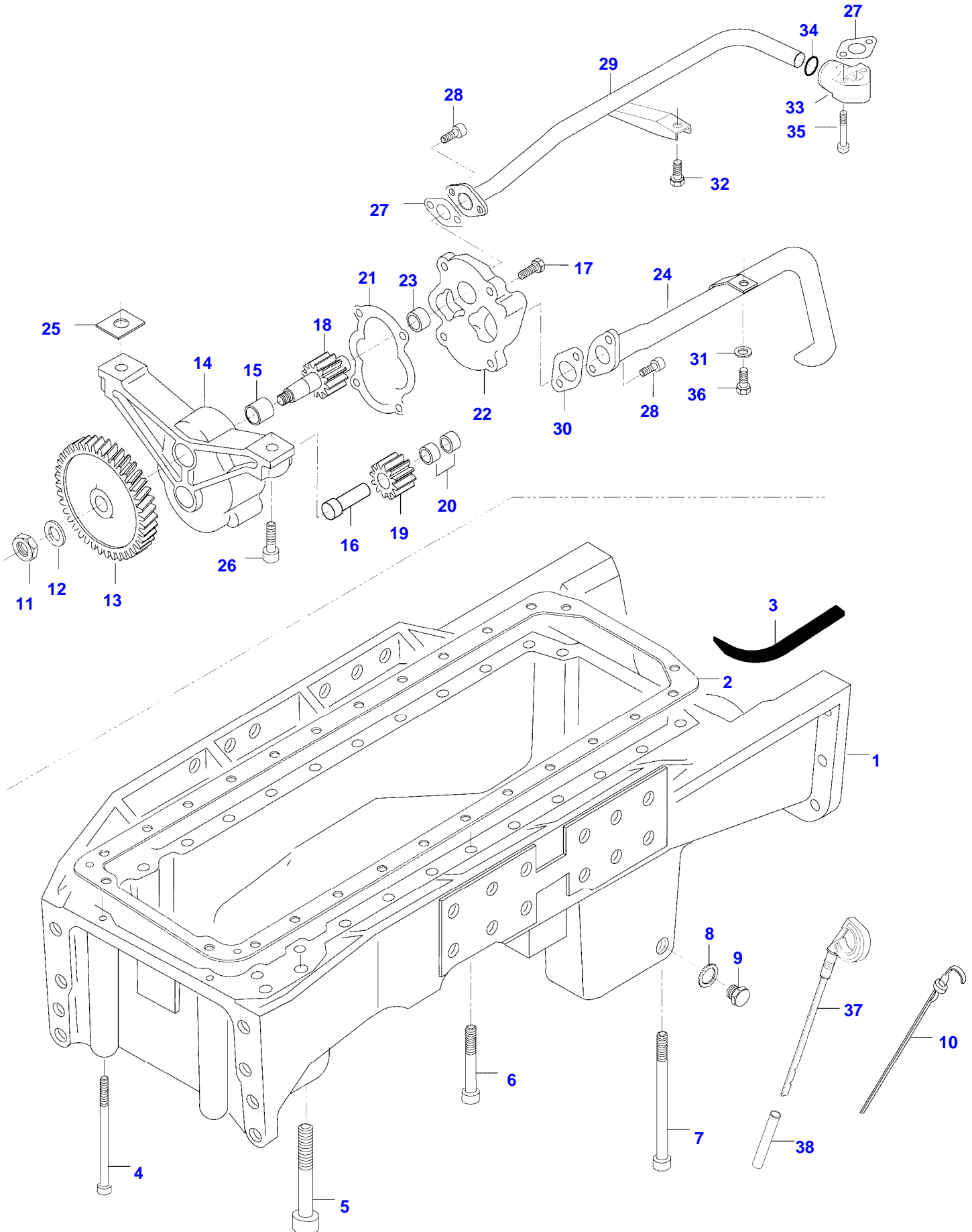

Item	Part Number	Qty	Description Comments
1	V836855501	1	OIL SUMP
2	V836322183	1	OIL SUMP GASKET S2
3	V836129727	2	GASKET S2
4	V581704830	2	HEX SOCKET SCREW M8 X 160
5	V581706350	4	HEX SOCKET SCREW M16 X 90
6	V581705130	22	HEX SOCKET SCREW M10 X 80
7	V581705250	2	HEX SOCKET SCREW M10 X 180
8	V615881827	1	SEALING WASHER S2
9	V836655493	1	PLUG
10	V836847652	1	DIPSTICK -XX
37	V836666908	1	DIPSTICK XX- ORANGE
38	V836666910	1	OIL DIPSTICK GUIDE PIPE XX-
11	V836855300	1	LUBRICATING OIL PUMP
11	V504861000	1	NUT . M10
12	V836122910	1	WASHER .
13	V836338667	1	GEAR .
14	V836338186	1	FRAME .
15	V836322909	1	BUSHING ..
16	V836322906	1	OIL PUMP SHAFT ..
17	V528801380	4	HEX CAP SCREW . M8 X 20
18	V836338182	1	OIL PUMP SHAFT .
19	V836338180	1	GEAR,OIL PUMP .
20	V836322909	2	BUSHING ..
21	V836338188	1	GASKET . S2
22	V836855297	1	COVER .
23	V836322909	1	BUSHING ..
24	V836859670	1	PIPE
25	V836007871	X	SHIM
26	V581805050	2	HEX SOCKET SCREW M10 X 40
27	V836008449	2	GASKET S2
28	V581804600	4	HEX SOCKET SCREW M8 X 20
29	V836866569	1	OIL PIPE
30	V836338201	1	GASKET S2
31	V500150840	1	WASHER

Item	Part Number	Qty	Description Comments
32	V528801360	1	HEX CAP SCREW M8 X 16
33	V836866563	1	ADAPTER FLANGE
34	V614702230	1	O-RING S2
35	V581804680	2	HEX SOCKET SCREW M8 X 55
36	V528801400	1	HEX CAP SCREW M8 X 25

T130CH TRACTOR (TC,TCH SERIES)
SPIMG-013-21-18

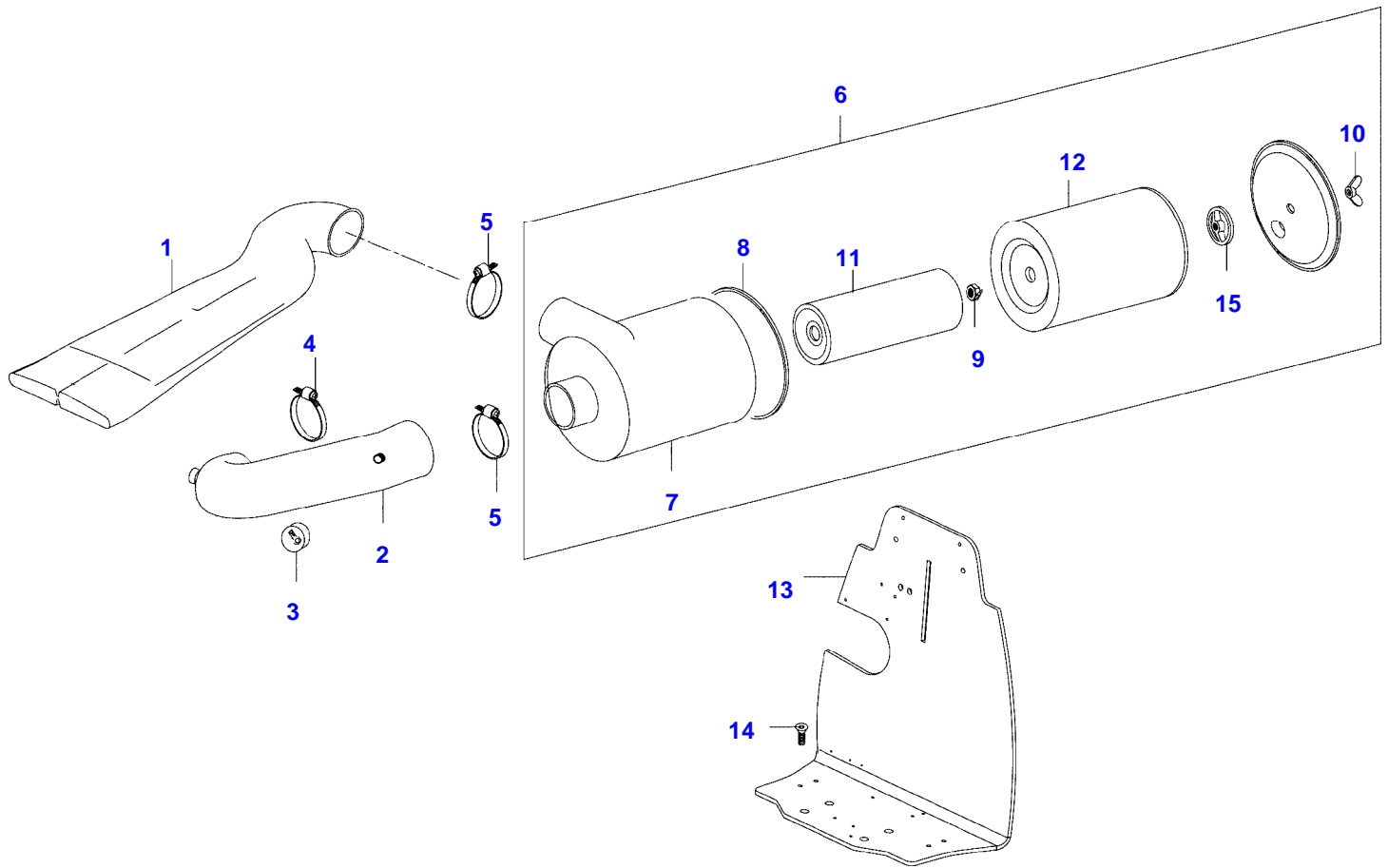

Item	Part Number	Qty	Description Comments	Technical Specification
1	V34517400	1	SUCTION PIPE	
2	V34517800	1	SUCTION PIPE	
3	V34654000	1	SENSOR	65 BAR
4	VGP3933	1	HOSE CLIP	D=95 SMS2298
5	VGP3936	2	HOSE CLIP	D=138 SMS2298
6	V34657200	1	AIR FILTER ASSEMBLY	
7	NS	1	NON-SERVICEABLE PART	
			HOUSING	
8	V33572300	1	GASKET	L=960
9	VJB8905	1	LOCKNUT	M10 SFS_EN_ISO_10511
			NUT	
15	V35315600	1	NUT	
10	VJC1610	1	BLADE NUT	M10 DIN315 G5 ZNE
11	V836862574	1	SECONDARY AIR FILTER ELEMENT	
12	V836862573	1	PRIMARY AIR FILTER ELEMENT	
13	V34460810	1	STAY	
14	VHE6700	4	SCREW	M10 X 25 SFS_EN_ISO_10642 10.9



Suggest:

For more complete manuals. Please go to the home page.

<https://www.ebooklibonline.com>

If the above button click is invalid. Please download this document first, and then click the above link to download the complete manual.

Thank you so much for reading

T130CH TRACTOR (TC,TCH SERIES)
SPIMG-013-21-20

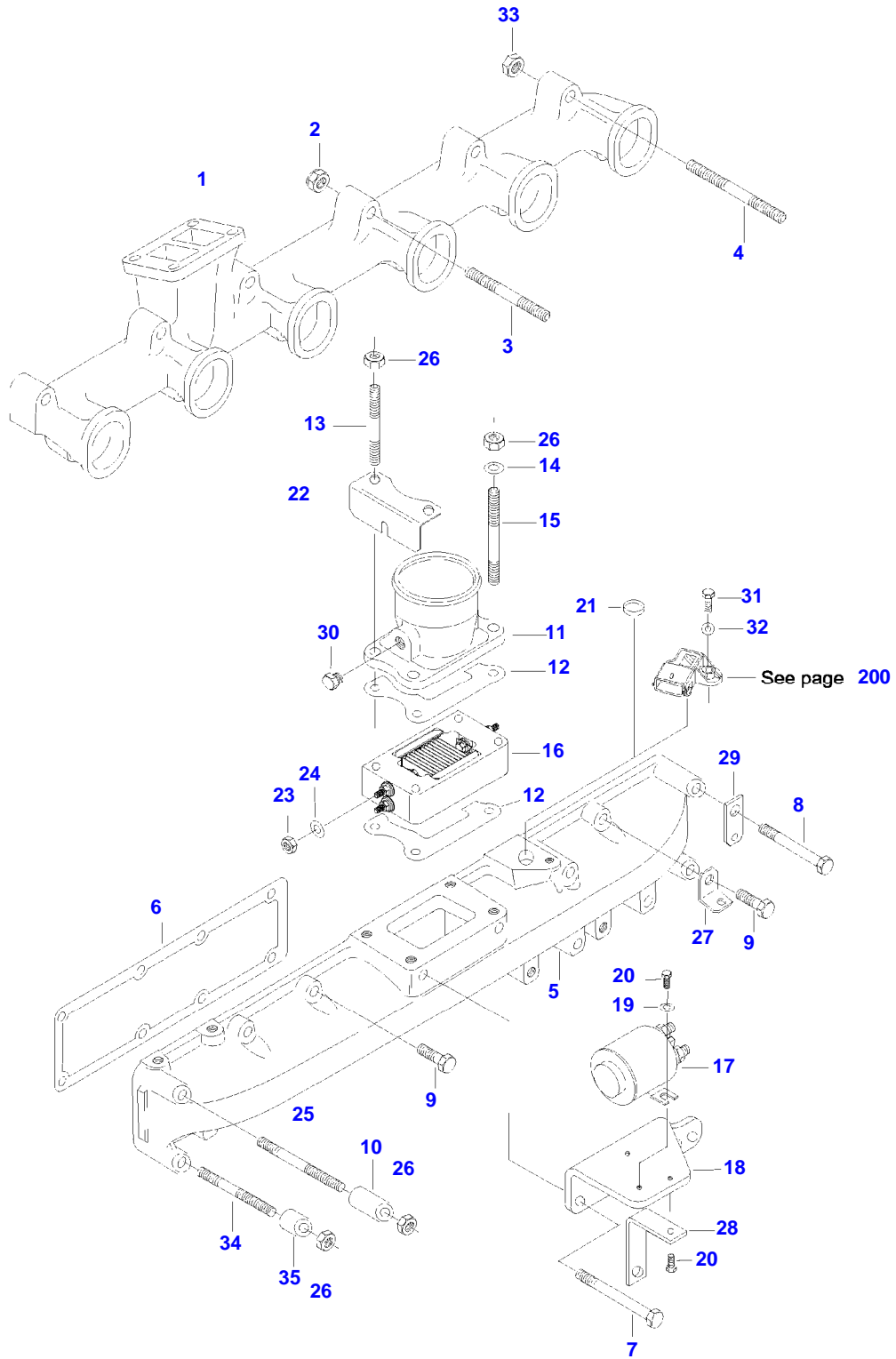

Item	Part Number	Qty	Description Comments
1	V836859378	1	EXHAUST MANIFOLD
2	V513601002	9	NUT
3	V836855995	9	STUD BOLT
4	V836859034	3	STUD BOLT
5	V836866827	1	INTAKE MANIFOLD
6	V836847496	2	INTAKE MANIFOLD GASKET S1
7	V529801552	2	HEX CAP SCREW
8	V529801470	4	HEX CAP SCREW M8 X 60
9	V528801410	6	HEX CAP SCREW M8 X 30
10	V836119296	1	SPACER PIECE
12	V836847532	2	GASKET S1
13	V546801470	2	STUD BOLT M8 X 60
14	V500950800	4	SPRING WASHER
15	V546801490	2	STUD BOLT M8 X 70
16	V836864398	1	INTAKE AIR PREHEATER
17	V836666759	1	SOLENOID
18	V836766752	1	BRACKET
19	V500150532	2	WASHER
20	V528800752	3	HEX CAP SCREW M5 X 12
21	V640016012	1	CUP PLUG
22	V836866714	1	GROUNDING PLATE
23	V504600602	2	NUT M6
24	V500050642	2	WASHER
25	V546801530	1	STUD BOLT M8 X 90
26	V504800800	6	NUT M8
27	V836855774	1	SUPPORT
28	V836752057	1	SUPPORT
29	V836446243	1	SUPPORT
30	V640305012	1	PLUG
31	V528801082	1	HEX CAP SCREW M6 X 20
32	V500050642	1	WASHER
33	V504601000	3	NUT M10
34	V546801510	1	STUD BOLT M8 X 80
35	V836117352	1	SPACER PIECE
200			SEE PAGE 01-0022

<https://www.ebooklibonline.com>

Hello dear friend!

Thank you very much for reading.

Enter the link into your browser.

The full manual is available for immediate download.

<https://www.ebooklibonline.com>