

Component Check

This section describes the test procedure, adjustment and overhaul of components subject to individual assessment. The recommended adjustment values for each engine are specified in the respective sections.

Injection Nozzles – Pressure and Atomization Testing



ATTENTION: KEEP the body away from the oil jets from the nozzles. The test fluid can penetrate into the skin, get in the blood stream, causing poisoning and may lead to death.

1. REMOVE the injector nozzle. For more information, REFER TO the item “Fuel Injector Support – Removal and Installation”, in Section 220-05.

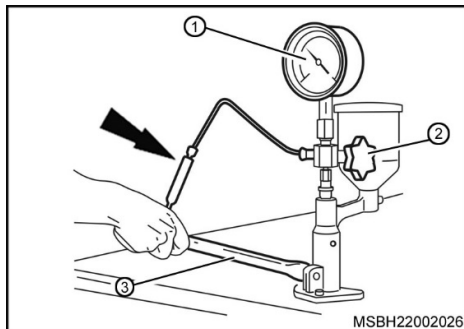

2. INSTALL THE injector nozzle in the test equipment.
 - a) OPEN the test device valve (2);
 - b) MOVE the lever (3) in the equipment to one pump per second frequency;
 - c) Using the pressure gauge (1), READ the opening pressure at the moment the spray starts.

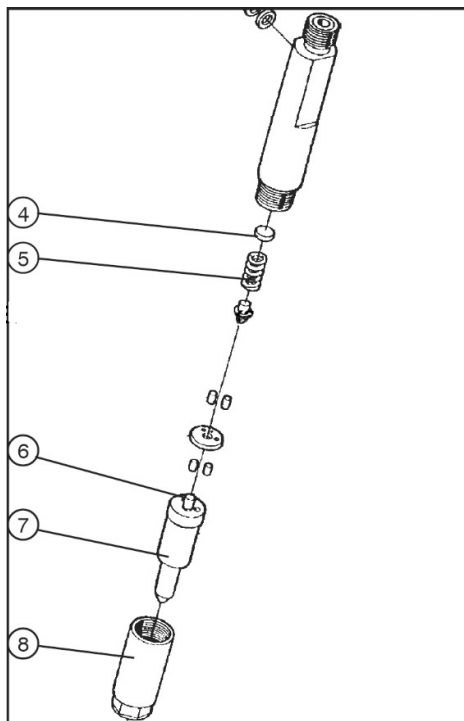

3. The pressure adjustment is performed by changing the shim(s) (4) thickness on the actuating spring (5): by increasing the shim thickness, the pressure increases and vice-versa.

NOTE: the figures shown are just illustrative, as the nozzles construction, and the variety of brands, may change, according to the model and the application in the engine.

- (6) Needle
- (7) Fuel nozzle holder
- (8) Housing, bottom part

Injector Nozzles – Tightness Test



ATTENTION: KEEP the body away from the oil jets from the nozzles. The fluid can penetrate into the skin, get in the blood stream, causing poisoning and may lead to death.

1. REMOVE the injector nozzle. For more information, REFER TO the item “Fuel Injector Support – Removal and Installation”, in Section 220-05.

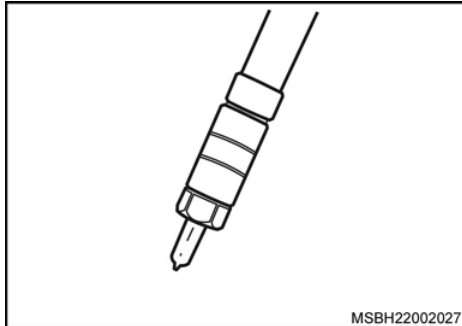

2. **NOTE:** When the engine presents operational failure due to damaged nozzles, it is possible to find out which one is damaged: LET the engine run at idle and RELEASE the intake connection of all nozzles - one at a time: for the nozzle(s) which do not cause the engine to present a decrease in the RPM, is damaged.

INSTALL THE injector nozzle in the test equipment.

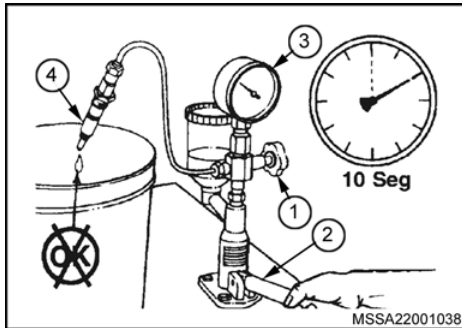

OPEN the test device valve (1).

APPLY a controlled pressure (2) of 20 bar (3) below the recommended pressure to open the nozzle.

There should not be any drop of oil coming out of the nozzle (4) before 10 seconds.

Injector Nozzles – Atomization and Noise Testing



ATTENTION: KEEP the body away from the oil jets from the nozzles. The fluid can penetrate into the skin, get in the blood stream, causing poisoning and may lead to death.

1. REMOVE the injector nozzle. For more information, REFER TO the item “Fuel Injector Support – Removal and Installation”, in Section 220-05.
2. INSTALL THE injector nozzle in the test equipment.

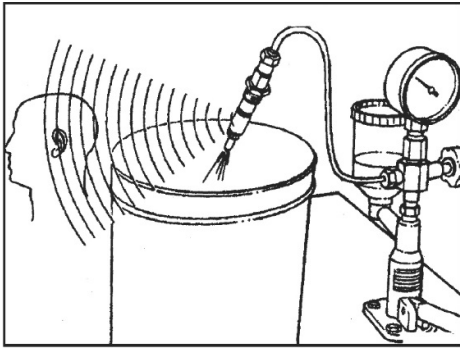

3. CHECK if the atomization presents the following characteristics:
 - The atomization must be very fine, forming a kind of mist.
 - The atomization must occur in an homogeneous way, i.e., it must be achieved the same result for all holes: spraying quality and jets angle.
4. PLEASE NOTE the characteristic noise that must occur during the atomization.

This noise, which sounds like a "snoring", indicates the freedom of movements for the needle, inside the nozzle holder.

Cylinder Compression Test

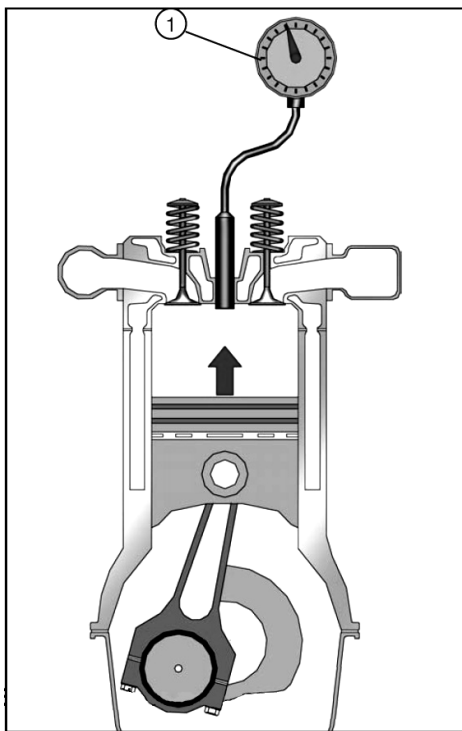

Compression is the achieved pressure on full piston compression stroke.

Due to several factors that may interfere with the achieved pressure value during the tests, it is not usual to specify very accurate pressures: battery and starter system condition, atmospheric pressure, room temperature and type of gauge used, can cause variations on the readings for a given engine.

For the engines 420DS and 620DS, CONSIDER the specified in the item "[Specifications](#)", in this section.

A compression test can reveal problems with the piston ring seals, on the valves, or on a cracked cylinder head gasket, requires an overhaul of engine.

The major reason for the compression test is to allow a comparative analysis among the cylinders: accentuated differences among the reading clearly indicate irregularities.

The service limit is considered acceptable if the difference on the pressure among the cylinders is about 350 kPa (50 lbf/in²) or 3.5 kgf/cm².

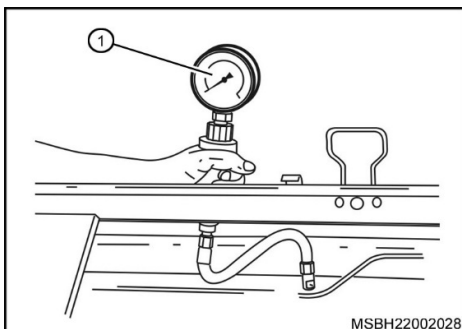

Test procedure:

- a) CHECK if the starter system is in good condition.
- b) REMOVE the air filter primary element to maximum reduce the air intake restriction.
- c) MAKE SURE all valves are adjusted: e.g., a restricted valve can interfere with the readings.
- d) CLEAN the engine top and REMOVE all nozzles, protecting the holes in the housing to prevent dirties to get inside the engine.

<https://www.ebooklibonline.com>

Hello dear friend!

Thank you very much for reading.

Enter the link into your browser.

The full manual is available for immediate download.

<https://www.ebooklibonline.com>

- e) INSTALL a pressure gauge (1) in one hole, as illustrated.
- f) TURN on the starter motor and NOTE the reading on the gauge (1). WRITE DOWN the value.
- g) FOLLOW the same procedure for the other cylinders.

Evaluation of the Cylinder Sleeves Wear and Ovalization

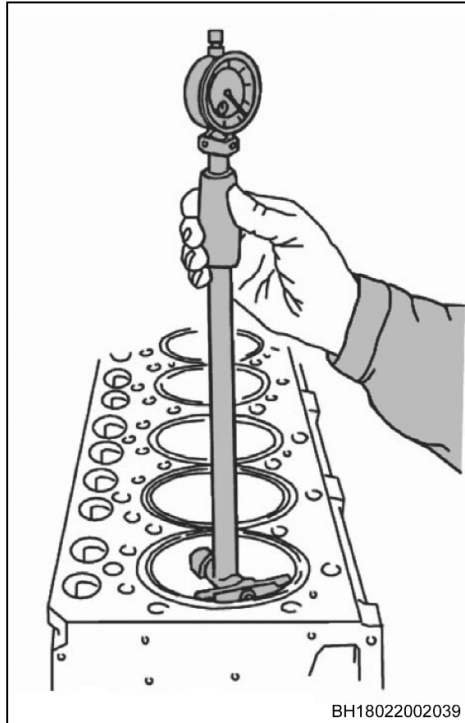

1. MEASURE wear and ovalization of the cylinder sleeve.
 - a) SET the dial gauge to zero with the help of a micrometer or new cylinder sleeve, to indicate the diameter of a not worn cylinder sleeve (108.00 mm).
 - b) CLEAN the sleeve inner surface thoroughly before the measurement.
 - c) PERFORM the measurement crosswise at the sleeve top end, lower end and at the middle.
 - d) CHECK the gauge reading for maximum wear and ovalization (COMPARE with the specified values).

For more information, REFER TO the item "Specifications", in this section.

REMOVAL AND INSTALLATION

Engine assembly 620 DS

Removal

Engine removal usually must be done when replacing engines, for engine inner kits maintenance, external aggregates such as: crankcase, distribution box, crankshaft hub front sealing ring, etc.

NOTE: all procedures involving opening the tractor must be executed in accordance with the appropriate safety precautions.

NOTE: MAKE disconnections at the most appropriate point for each case and IDENTIFY hoses and tubes to avoid difficulties in assembling.

NOTE: all hoses and loose connections in general should be capped to prevent contamination and leakage.



CAUTION: before and during the opening, MAKE SURE that all connections have been properly turned off, between the movable part (front tractor) and the fixed part (back).

1. REMOVE the right and left side protective cover of the engine. For more information, REFER TO the item "Engine [Right or Left Side Protective Cover – Removal and Installation](#)", in [Section 881-01](#).

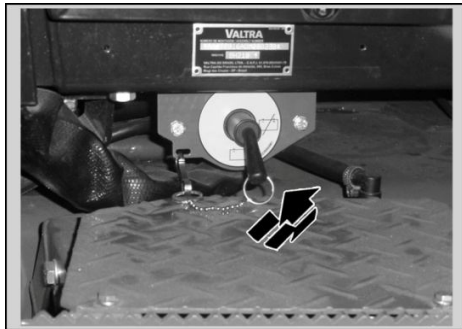

2. TURN OFF tractor main switch (arrow) turning the lever anticlockwise.

3. OPEN the tractor between the engine and the front axle tractor. For more information REFER TO item "[Tractor Opening Between the Engine and the Front Axle – Opening and Closing](#)", in [Section 110-05](#).

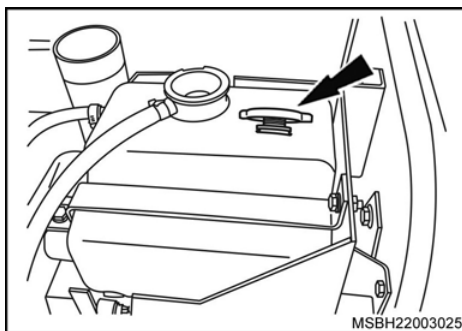

4. With the engine turned off and cold, REMOVE the expansion reservoir cover (arrow).

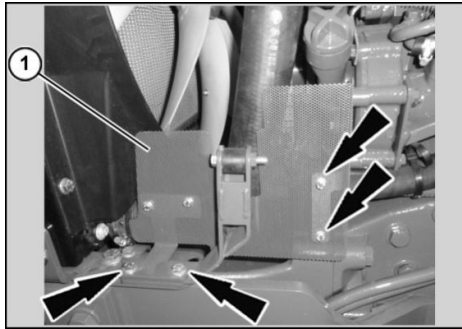

5. REMOVE the finger protection screen (1 and 2), removing the fixing screws (arrows).

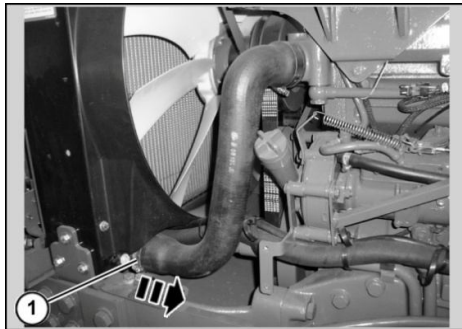
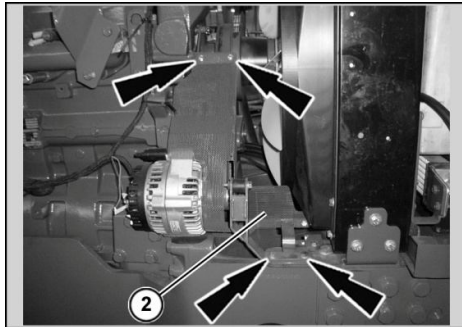

6. DRAIN cooling system by performing the following procedures:
- RELEASE the fixing clamp (1) in the hose inferior end connecting the water pump to the radiator inferior tank.
 - DISCONNECT the hose lower end.
 - DIRECT the hose to an appropriate container.



ATTENTION: The coolant is a mix of water and ethylene glycol. This solution should not be discarded in nature. Disposal should be done by a qualified company.

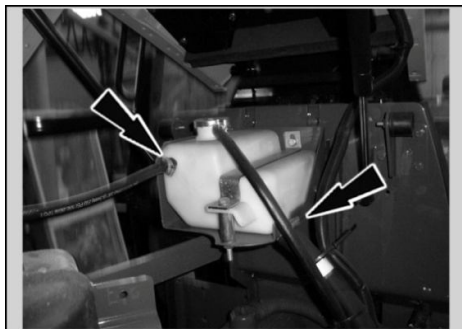

7. RELEASE the clamps and DISENGAGE the hoses (arrows) from the expansion reservoir.

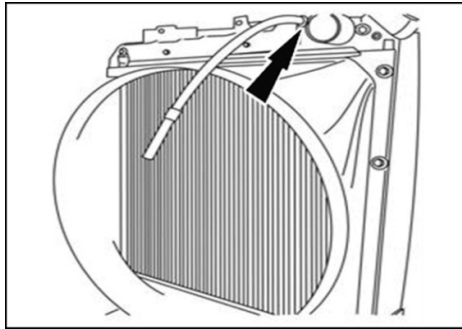

8. RELEASE the clamps and DISENGAGE the hoses (arrows) from the expansion reservoir to the water radiator.

9. REMOVE the engine exhaust pipe. For more information, REFER to item “[Engine Exhaust Pipe – Removal and Installation](#)”, in Section 881-01.

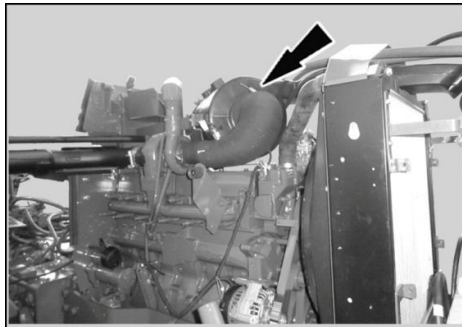

10. RELEASE the clamp (arrow) from the hose fixed on the air filter.
11. REMOVE the air filter hose.



12. DISCONNECT the duct (arrow) from the filter air inlet.

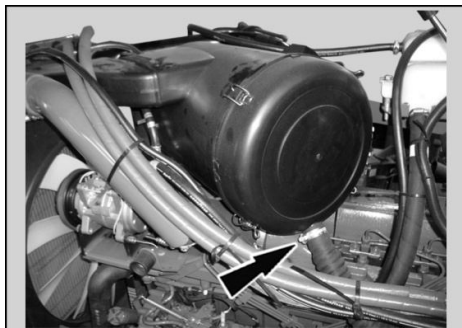

13. RELEASE the powder ejector hose clamp.
14. DISENGAGE the hose connected to the air filter.

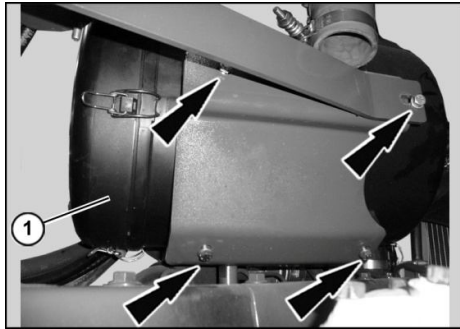

15. RELEASE and REMOVE the fixing screws (arrows) of the air filter support.

16. REMOVE the air filter (1).

17. DRAIN the air conditioner system. For more information, REFER TO the item "[Air Conditioner System – Drainage](#)", in [Section 882-03](#).

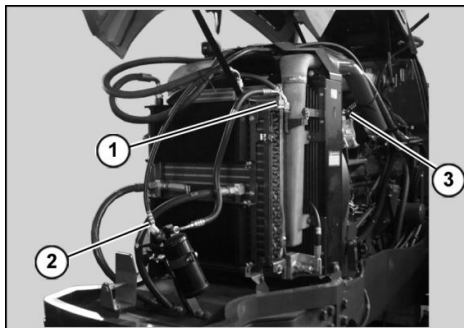

18. RELEASE and DISENGAGE from the hoses region:

- (1) Air conditioned condenser.
- (2) Air conditioned drier filter.
- (3) Low pressure air conditioned hose.
- (4) Hydraulic system oil radiator inlet.
- (5) Hydraulic system oil radiator outlet.
- (6) Diesel system oil radiator inlet.
- (7) Diesel system oil radiator outlet.
- (8) Dryer filter electric connector.

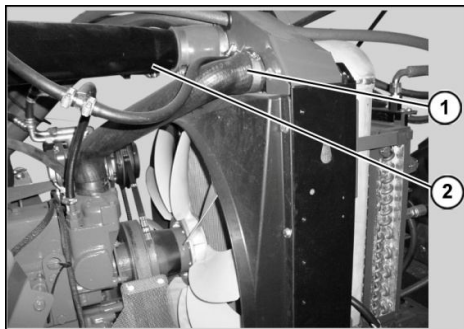
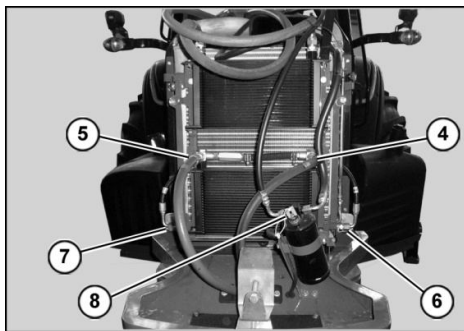

19. RELEASE clamps and DISENGAGE the superior hose from water radiator and intercooler pipes.

- (1) Water radiator superior hose.
- (2) Right intercooler tube
- (3) Left intercooler tube

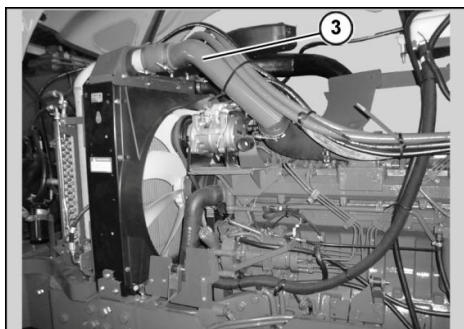

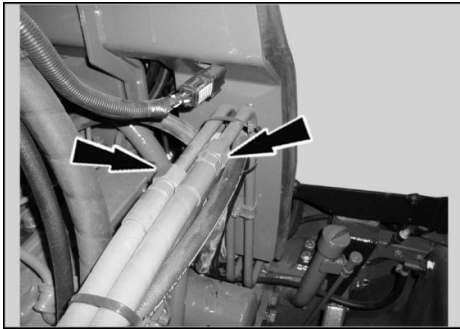

20. RELEASE the fixing connections (arrows) from the gearbox system oil radiator tubes.

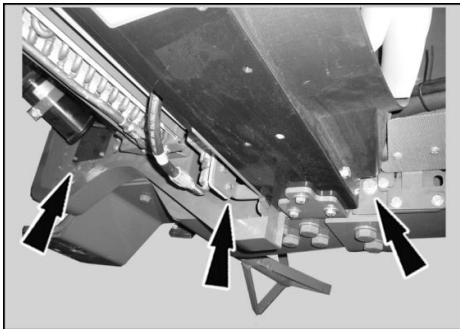

21. RELEASE and REMOVE the fixing screws (arrows) of the right and left sides radiator supports.

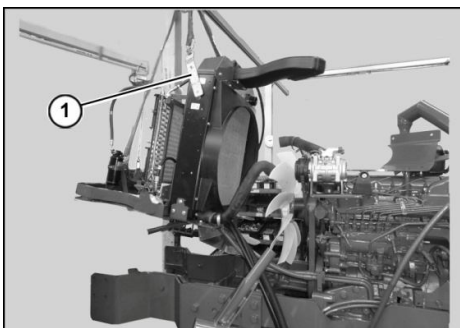
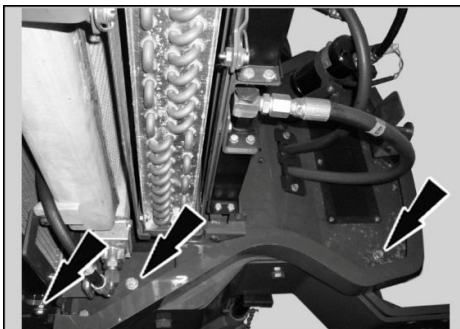

22. PREPARE an electric hoist/hoist, using an device for lifting the radiator set coupled to the hook.

23. INSTALL the device (1) (code C1010406) and remove the radiator set and support.

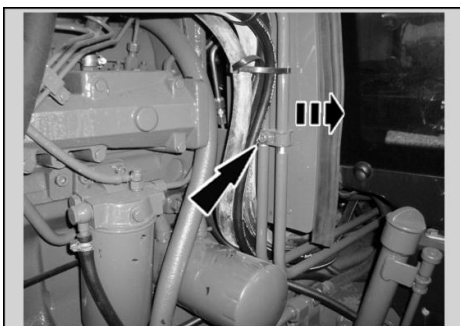

24. RELEASE and REMOVE the fixing screw (arrow) from clamp fixing radiator tubes on the gearbox system, with the fire proof plate.

25. MOVE the tubes (arrows) so they do not disturb the engine removal.



Suggest:

For more complete manuals. Please go to the home page.

<https://www.ebooklibonline.com>

If the above button click is invalid. Please download this document first, and then click the above link to download the complete manual.

Thank you so much for reading

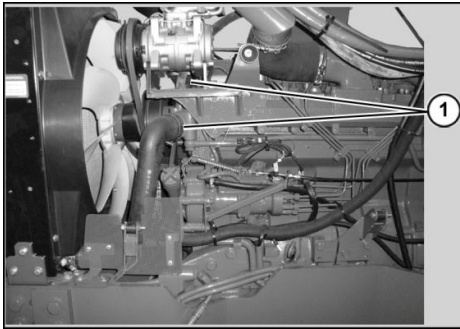

26. RELEASE the fixing clamps (1 and 2) and DISENGAGE the front and rear hoses which are connected to the cylinder head superior region.

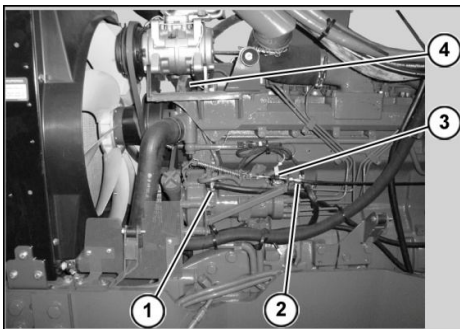
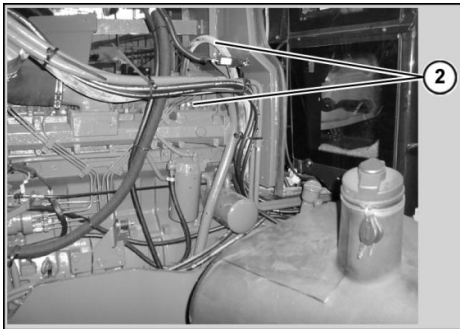

27. RELEASE and DISENGAGE:

- (1) The return hose of diesel injection pump.
- (2) The accelerator cable.

28. DISCONNECT and REMOVE the electric connectors to the engine left side:

- (3) Injection pump solenoid.
- 4) Air conditioner compressor.

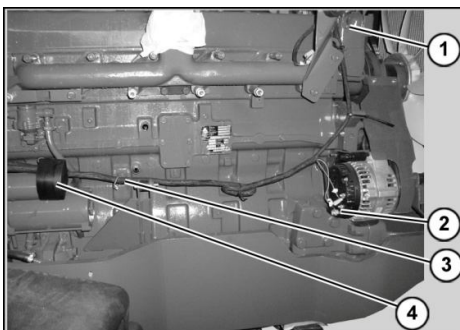

29. DISCONNECT electric connectors to the engine right side:

- (1) Engine cooling system sensor
- (2) Alternator.
- (3) Engine oil temperature sensor.
- (4) Starting engine.

30. Displace the harness to the engine back area.



31. RELEASE the fixing clamp (arrow) and REMOVE the diesel feeding hose on the settler filter.

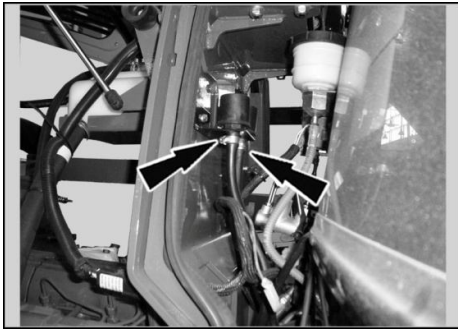

32. RELEASE the fixing clamps (arrows) and DISENGAGE the diesel tank breathe hoses.

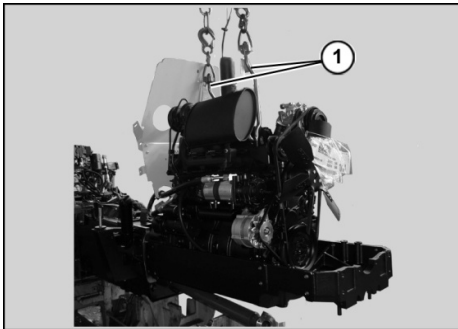

33. PREPARE an electric hoist/hoist using two specific devices (code D505) (1) for lifting, connected to the hook.

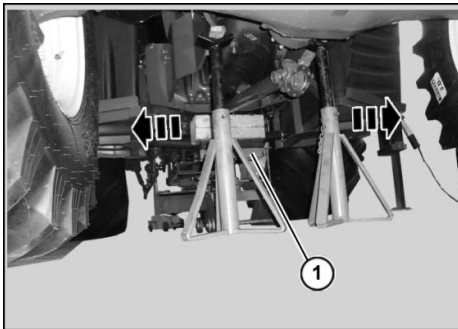

34. LIFT the engines so it is possible to remove the brackets (arrows) from the frame rail.

35. REMOVE the brackets and lower the electric hoist/hoist until the tractor is supported on the support cart (1) placed below the hydraulic tank.

NOTE: KEEP the engines attached to the lifting device together with the electric hoist/hoist to be removed with the frame rails.

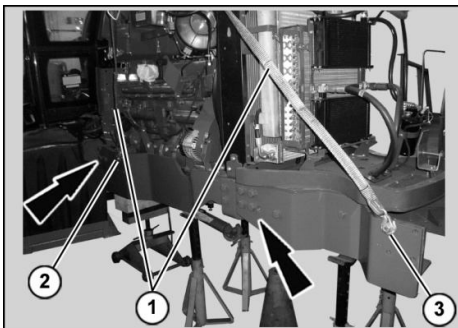

36. PREPARE the electric hoist/hoist and INSTALL a strap (1) attached with eyebolts (2 and 3) on the frame rails in order to remove them from the tractor.

37. RELEASE and REMOVE the fixing screws (arrows) from right and left frame rail.

38. REMOVE the left and right frame rail.

<https://www.ebooklibonline.com>

Hello dear friend!

Thank you very much for reading.

Enter the link into your browser.

The full manual is available for immediate download.

<https://www.ebooklibonline.com>