

Operator's Manual

FENDT

IDEAL Series Combine

IDEAL 7

IDEAL 7PL

IDEAL 7T

IDEAL 8

IDEAL 8PL

IDEAL 8T

IDEAL 9

IDEAL 9PL

IDEAL 9T



Breganze

AGCO S.p.A. - Via F. Laverda, 15/17 - 36042

BREGANZE (VI) – Italy.

FENDT is a worldwide brand of AGCO

© AGCO 2019

Original Operator's Manual

March 2019

ACX2336050

EME

English

TABLE OF CONTENT

- Safety 1
- Introduction 2
- Operation 3
- Maintenance 4
- Troubleshooting 5
- Specifications 6
- Assembly 7
- Index 8

1 Safety

1.1	Introduction	21
1.1.1	Safety symbol	21
1.1.2	Warnings	21
1.1.3	Safety signs	22
1.1.4	A word to the operator	22
1.1.5	This manual	23
1.1.6	Engine	23
1.1.6.1	Safety instructions	23
1.2	Operation	25
1.2.1	Prepare for operation	25
1.2.2	General information	25
1.2.3	Emergency situations	26
1.2.4	Personal protective equipment	27
1.2.5	Emergency exit	27
1.2.6	Seat instructions	27
1.2.7	Operator out of seat	28
1.2.8	Shield and guards	28
1.2.9	Exhaust warning	29
1.2.10	Flying debris	29
1.2.11	Handrails	29
1.2.12	Header safety	30
1.2.13	Grain tank safety	30
1.2.14	Straw chopper, chaff spreader, and straw spreader safety	30
1.3	Travel on public roads	31
1.4	Maintenance	33
1.4.1	Operator maintenance	33
1.4.2	General maintenance information	33
1.4.3	Fire prevention and first aid	34
1.4.4	High pressure leaks	35
1.4.5	Engine safety	36
1.4.6	Fuel safety	37
1.4.6.1	Ultra-low sulfur diesel	38
1.4.7	Battery safety	38
1.4.8	Accumulator safety	39
1.4.9	Replacement parts	39
1.4.10	Proper disposal of waste	39
1.5	Safety and informational signs	41
1.5.1	Decal locations	41
1.5.2	Lubrication points, right side	43
1.5.3	Lubrication points, left side	44
1.5.4	Break Glass - Exit	44
1.5.5	Lift point	44
1.5.6	Tow point	45
1.5.7	Danger - Entanglement hazard	45
1.5.8	Warning - Entanglement hazard	45
1.5.9	Tiedown point	45
1.5.10	Power off delay	46
1.5.11	Battery positive terminal	46
1.5.12	Battery disconnect	46
1.5.13	Battery negative terminal	46

<https://www.ebooklibonline.com>

Hello dear friend!

Thank you very much for reading.

Enter the link into your browser.

The full manual is available for immediate download.

<https://www.ebooklibonline.com>

1.5.14	12V/120W	47
1.5.15	Main fuses	47
1.5.16	Telescopic deck handrail	47
1.5.17	Unloader drive	47
1.5.18	Safety alert - Fire extinguisher	48
1.5.19	Warning - Flying objects hazard	48
1.5.20	Warning - Explosion hazard	48
1.5.21	Burn hazard - radiator	48
1.5.22	Burn hazard - hot surface	49
1.5.23	Impact hazard, coiled spring, variator	49
1.5.24	Jack point	49
1.5.25	No step	49
1.5.26	Lug nut torque, front wheels	50
1.5.27	Lug nut torque, rear wheels	50
1.5.28	Diesel exhaust fluid	50
1.5.29	Ultra low sulfur diesel	51
1.5.30	Warning - Hydraulic fluid pressure	51
1.5.31	Explosion hazard	51
1.5.32	Warning - Crushing hazard	51
1.5.33	Warning - Crushing hazard	52
1.5.34	Flying objects hazard	52
1.5.35	Crush hazard	52
1.5.36	Fall hazard	52
1.5.37	Warning - Shut off engine	53
1.5.38	Warning - Bystander alert	53
1.5.39	Operators manual	53
1.5.40	Danger - Electrical hazard	53
1.5.41	Warning - Autoguide on public roads	54
1.5.42	Warning - Crush hazard	54
1.5.43	Warning - Crush hazard	54
1.5.44	Warning - Seat belt	54
1.5.45	Reflector location	55
1.5.46	Reflector yellow	58
1.5.47	Reflector red	58
1.5.48	Reflector orange	58
1.6	Safety devices	59
1.6.1	Emergency exit	59
1.6.2	Seat belts	59
1.6.3	Fall protection rails	59
1.6.4	Header lift-cylinder stop	61
1.6.5	Engage the feeder house cylinder stop	61
1.6.6	Disengage the feeder house cylinder stop	62
1.6.7	Shield tool	62
1.6.8	Leveling system	62
1.6.9	Reverse alarm	63
1.6.10	Fire extinguisher	63
1.7	Additional information	65
1.7.1	Noise level in the cab	65
1.7.2	Vibrations in the cab	65
1.7.3	Electromagnetic emissions	65
1.7.4	Statutory regulations	66

1.1 Introduction

1.1.1 Safety symbol

The safety symbol tells you about a potentially hazardous area!

Look for the safety symbol in this manual and on the machine. The safety symbols tell you that there is important safety instructions in the manual.

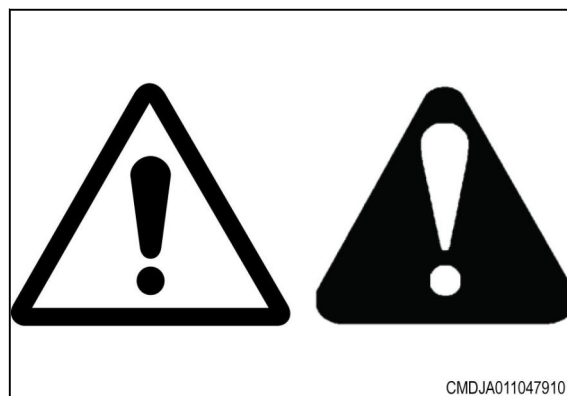

Fig. 1

1.1.2 Warnings

Agricultural accidents can be prevented with your help.

All accident prevention depends on the full co-operation of the persons using or involved with service or maintenance of the machine.

Most accidents can be avoided by observing simple safety rules.

The best safety system is one in which the operator observes all applicable regulations for machine safety and maintenance.

Some of the illustrations contained in this manual were obtained by photographing combine models of the same series, which may be differently equipped. This means that apparent discrepancies may result between your combine and those depicted in this manual.



DANGER: This symbol is used in this manual whenever your safety is involved.

Take the time to read and follow the instructions. Most importantly, be careful!

You can never be too prudent.

In order to provide a better view, certain photographs or illustrations in this manual may show an assembly with the safety guards open or removed.

Fit and close all guards prior to machine operation.

Personal protection

Three types of warning signs appear in this manual and on the decals applied to the machine (**Caution**, **Warning** and **Danger**) followed by specific instructions or decals with symbols clearly illustrating the type of hazard.

These instructions involve your safety and the safety of people working nearby.

Pay particular attention to these warnings.



CAUTION: Indicates a potentially dangerous situation.

If not avoided, it may result in minor injuries.



WARNING: Indicates a potentially dangerous situation.

If not avoided, it may result in serious injuries.

1. Safety



DANGER: Indicates a potentially dangerous situation.

If not avoided, it may result in very serious injuries or even death.

Failure to follow the instructions related to the terms **Caution, Warning** and **Danger** may result in minor or serious injuries or even death.

Machine safety

Other types of advice (**Note, Important**) are followed by special instructions referring to the safeguarding of the machine.

NOTE:

Highlights and describes correct techniques or procedures to be adopted by the operator.

IMPORTANT:

Informs the operator that unless a special procedure is followed, damage, including serious damage, could be caused to the machine.

1.1.3 Safety signs



WARNING:

Do not remove the safety signs. Replace safety signs that you cannot read, are damaged, or are missing.

Clean the machine surface with a weak soap and water solution before you replace the safety signs. Replacement safety signs are available from your dealer.

Always make sure that safety signs are in the correct locations and that you can read the safety signs. Illustrations of safety sign locations are at in this section.

Keep the safety signs clean. If necessary, use a weak soap and water solution.

1.1.4 A word to the operator

It is your responsibility to read and understand the safety section in this manual and the manual for all implements before you operate this machine. You are responsible for your safety. Good safety procedures prevent injury to you and the persons around you.

Make the information in the safety section of this manual a part of your safety procedure. This safety section is written only for this type of machine. Safety is your responsibility. You can prevent injury and death.

This safety section gives basic safety examples that can occur during the operation and maintenance of your machine. This safety section is not a replacement for safety instruction in other sections of this manual.

Injury or death can occur if the safety instruction is not obeyed.

Learn how to operate the machine and how to use the controls correctly.

Do not operate the machine if you do not know how to operate the machine. Do not let persons operate the machine that do not know how to operate the machine.

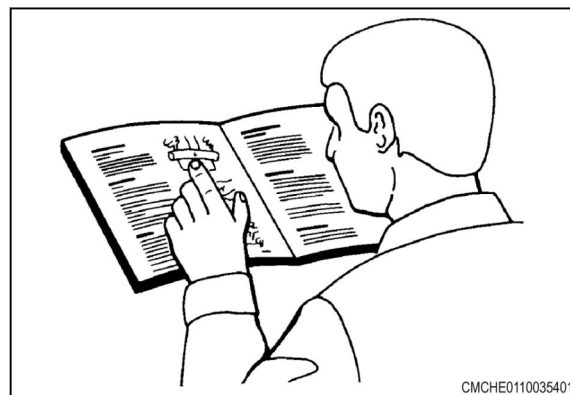

Fig. 2

Follow all safety instructions in the manuals and on the safety signs on the machine, the implements, and the attachments.

Use only approved attachments and implements.

Make sure that your machine has the correct equipment that is necessary by the local regulations.

**WARNING:**

Do not use alcohol or drugs that can have an effect on alertness or coordination. If you use prescription or 'over the counter' drugs, get medical advice about the safe operation of machines.

**CAUTION:**

If attachments or implements used with this machine have a different operator manual, see that operator manual for other important safety instructions.

**CAUTION:**

See the engine operation and maintenance manual for other important safety instructions.

**CAUTION:**

See the header operator manual for other important safety instructions.

1.1.5 This manual

This manual covers general safety instructions for this machine. Keep this manual with the machine.

Right and left, as used in this manual, are given as if you are in the operator seat.

The photos, illustrations, and data used in this manual were up to date when published, but in-line production changes can make your machine have small differences. The manufacturer reserves the right to redesign and change the machine as necessary without notification.

**WARNING:**

In some of the illustrations and photos used in this manual, shields or guards are removed. Operate the machine only with all shields and guards in the correct installed positions. If the removal of shields or guards is necessary to make a repair, they must be installed before operation.

1.1.6 Engine

1.1.6.1 Safety instructions



WARNING: The engine has components that move and can be hot.

When the engine is in operation or use, injury is possible.

Read the safety instruction, before you start the engine or do maintenance.

- When you operate the engine or do work near it, make sure that you use ear protection.
- If you start the engine in a closed area, make sure that there is sufficient airflow.
- Do not use an aerosol type of starter aid. (Risk of explosion, personal injury and engine damage)
- Start the engine only with the start switch in the cab.
- Stop the engine before you do maintenance or repair work.
- Do not have an open fire, smoking or sparks near the fuel system or the batteries. (Risk of explosion)
- Carefully open the radiator cap when the engine is warm because the cooling system is pressurized. The cooling liquid and lubricating oil in a warm engine cause injury when they touch the skin.
- Do not touch the exhaust manifold, turbocharger and the other warm parts of the engine.
- Always disconnect the negative (-) battery cable when you do maintenance or repair work on the electrical system.

1. Safety

- Do not open the high pressure pipe connectors of the fuel system when the engine is in operation. You must not open the connectors until 30 seconds after you stop the engine. If a jet of high pressure fuel touches your skin, the fuel goes through the skin, this causes injury. Get medical aid immediately.
- Keep the engine surfaces clean to prevent the risk of fire.
- **NOTE:** *Do not burn viton seals to dispose of them.*

At temperatures of more than 300 °C, for example if the engine is burned by a fire, the viton seals of the engine (for example the bottom O-ring of the cylinder liner) make very corrosive hydrofluoric acid. Do not touch the viton seals if their temperature was unusually high. Always use neoprene rubber or other applicable gloves and safety glasses. Clean the seals and the area with a 10 % calcium hydroxide or other alkaline solution. Put all removed material in sealed plastic containers and refer to your local authority for disposal.

- If fuel, lubricating oil or coolant frequently touch the skin this can cause irritation.
- If welding or equivalent work is to be done. Before you start, it is necessary to disconnect:
 - The connector from the electronic control unit.
 - The connector from the Selective Catalyst Reduction (SCR) supply module.

Important instructions

- Do not release oil and other liquids to the environment when you do maintenance on the engine. Refer to your local authority for disposal.
- The use of parts that are not equivalent in performance and specification to AGCO Parts are not permitted by the warranty. The use of parts that are not equivalent can decrease the performance of the emission control system. If you do not use AGCO Parts, you must make sure that the parts have approval by their manufacturer. All parts must be equivalent to AGCO Parts in performance and specification.

NOTE:

Always replace the engine gaskets, seals and washers when you open joints.

NOTE:

Do a check for the condition of the pipes and hoses during maintenance work. After the installation, make sure that the pipes and hoses do not have a leak. Always replace damaged pipes and hoses.

- Do not operate the engine at idle when not necessary. Set the engine to off.
- The engine gaskets contain no asbestos material.
- Be careful when you clean the engine with fluid at high pressure . Do not use high pressure fluid to clean the electrical equipment, fuel system or the radiator because you can cause damage. To remove moisture it is necessary to operate the engine when it is clean.

1.2 Operation

1.2.1 Prepare for operation

Read and understand the operating instructions and precautions in this manual before you operate or perform service on the machine.

Make sure that you know and understand the positions and operations of all controls. Make sure that all controls are in neutral and the parking brake is applied before you start the machine. Make sure that the steering wheel is in the center position and locked.

Make sure that all persons are a sufficient distance from your area of work before you start or operate the machine. Do checks on the controls and learn all controls in an area clear of persons and objects before you start work with the machine. Know the dimensions of the machine and have sufficient space available for operation. Do not operate the machine at high speeds around persons, buildings, other equipment, etc.

Always use correct procedures when you do tasks around and operate the machine. Do not let children or persons who do not know how to operate the machine operate the machine. Keep other persons away from your area of work. Do not let other persons ride on the machine.

Make sure that the machine is in the good mechanical condition. Make sure that the machine has the correct equipment as necessary by local regulations.

All equipment has a limit. Make sure you understand the speed, brakes, steering, stability, and load characteristics of this equipment before you start.

1.2.2 General information

When parking, park the machine on a solid level surface and lower the header to the ground. Put all controls in neutral, and apply the parking brake. Stop the engine and take the key with you.



WARNING: Whole body crushing hazard. A loss of hydraulic pressure or movement of the mechanism can cause the raised machine component to fall.

Personal injury or death can occur.

Install the lift cylinder stops before working on the machine to prevent movement.

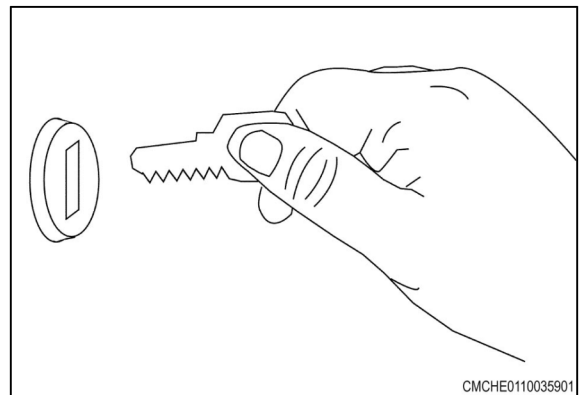

Fig. 3

Make sure the machine is in the proper operating condition according to the Operator Manual.

Always operate the machine with the control console turned on.

Do not dismount from moving machinery.

Stay off slopes too steep for operation.

Be aware of the size of the machine and have enough space available to allow for operation.



Suggest:

For more complete manuals. Please go to the home page.

<https://www.ebooklibonline.com>

If the above button click is invalid. Please download this document first, and then click the above link to download the complete manual.

Thank you so much for reading



DANGER:
Loss of stability. Risk of overturning.

Pay special attention because some activated devices (open grain tank extensions, open grain unloading auger, fully raised header, etc.) may affect the stability of the machine.

Do not use the machine in the following situations:

- When the maximum slope of the ground exceeds the maximum slope limit of the machine.
- If the correct tire pressures and correct operation of the levelling system (if equipped) has not been verified.
- If the ground is not firm or has sudden contour changes.
- The tires do not have sufficient traction on the ground.
- Close to the edge of ditches or steep drops.
- If correct securing of the header to the feeder house with the safety lock has not been done.
- If adequate ballast has not been applied to balance the machine on the rear axle (if any).
- If crossing weak bridges with paving that is in poor condition.
- If high speed, abrupt manoeuvres and fast tight cornering are used.

Stay off slopes too steep for operation. Keep the header as low as possible while going down hills. Never suddenly reverse the wheels to stop or back up.

Where possible avoid operating the machine near ditches, embankments, and holes. Reduce ground speed when operating on rough, slippery, or muddy surfaces and when turning or crossing slopes.

Related Links

[Travel on public roads](#) page 31

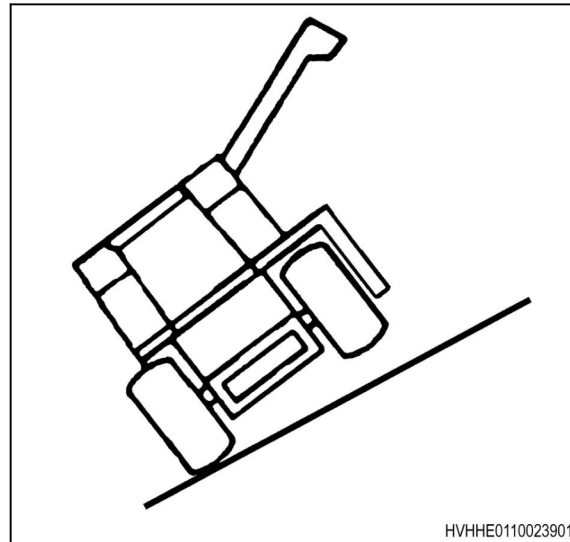

Fig. 4

1.2.3 Emergency situations

Stop the engine if there is an emergency situation.

1.2.4 Personal protective equipment

Put on all personal protective equipment (PPE) and protective clothes that are supplied to you or that are necessary for the conditions and by applicable laws. PPE includes equipment to prevent injury to your eyes, lungs, ears, head, hands and feet.

Always keep hands, feet, hair, and your clothes away from parts that move. Do not put on loose clothing, jewelry, watches, or other items that can tangle in parts that move. Tie up long hair that can also tangle in moving parts.

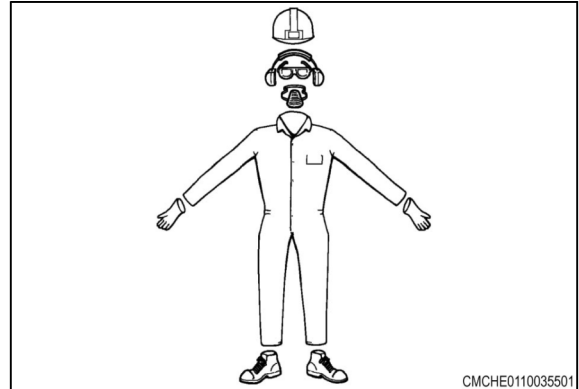

Fig. 5

1.2.5 Emergency exit

A hammer for emergency exit is above the right control console. The hammer is to break the right side glass to let you exit the cab in an emergency.

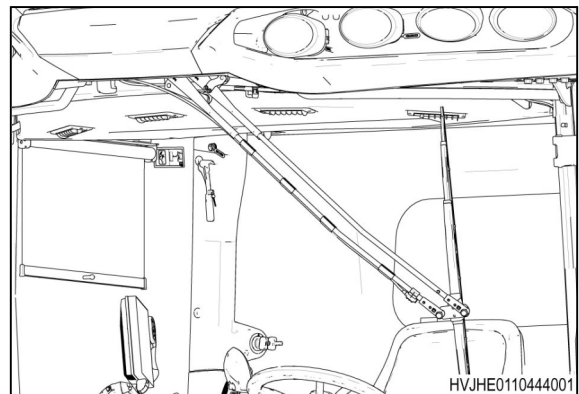

Fig. 6

1.2.6 Seat instructions

Put on the seat belt before you operate the machine. Always sit in the seat and have the seat belt on while you operate the machine. Replace the seat belts when they become worn or broken.

Do not use a seat belt loosely. Make sure that there is some tension on the seat belt. Do not wear the seat belt in a twisted condition or pinched between the structural parts of the seat.

Put on the seat belt if the instructional seat is used. Use the instructional seat only to train new operators or to find a problem. The instructional seat is only for short periods of use.

Do not let children use the instructional seat or be in the cab. Do not let other persons use the instructional seat or be in the cab.

Drive the machine at slower speed and on level ground when the instructional seat is used. Do not start, stop, or turn quickly when the instructional

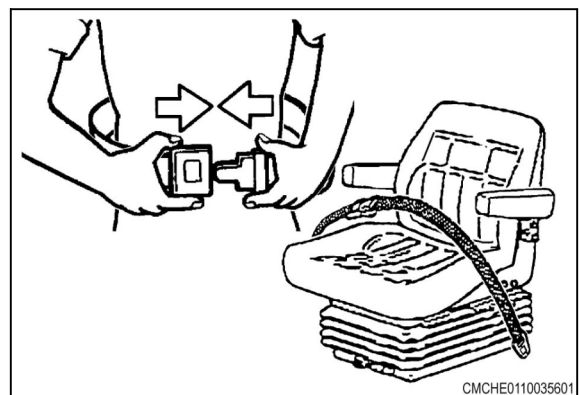

Fig. 7

<https://www.ebooklibonline.com>

Hello dear friend!

Thank you very much for reading.

Enter the link into your browser.

The full manual is available for immediate download.

<https://www.ebooklibonline.com>