

# COMBINE

# OPERATOR MANUAL

**FENDT™**  
**9390R CE**  
**Combine**

S/N: AGCF9390RCHC26101 and Up



**FENDT™  
9390R CE  
700738841 C Rev.**

**CONTENTS**

SAFETY .....	A-1
GENERAL INFORMATION .....	B-1
OPERATION .....	C-1
ADJUSTMENTS .....	D-1
LUBRICATION AND MAINTENANCE .....	E-1
SPECIFICATIONS .....	F-1
TROUBLESHOOTING .....	G-1
ACCESSORIES AND OPTIONS .....	H-1
ASSEMBLY .....	J-1
INDEX .....	K-1

## CONTENTS

---

## NOTES

**<https://www.ebooklibonline.com>**

Hello dear friend!

Thank you very much for reading.

Enter the link into your browser.

The full manual is available for immediate download.

**<https://www.ebooklibonline.com>**

# SAFETY

## Contents

Safety Alert Symbol .....	A-3
Safety Messages .....	A-3
Informational Messages .....	A-3
Safety Signs .....	A-4
A Word To The Operator .....	A-5
Operator Manual .....	A-6
Prepare For Operation .....	A-6
Operation .....	A-7
General Information .....	A-7
PPE (Personal Protection Equipment) .....	A-8
Seat Instructions .....	A-9
Shield and Guards .....	A-9
Exhaust Warning .....	A-10
Flying Debris .....	A-10
Handrails .....	A-10
Travel On Public Roads .....	A-11
Maintenance .....	A-12
General Information .....	A-12
Fire Prevention and First Aid .....	A-14
Checking for High Pressure Leaks .....	A-15
Engine Safety .....	A-15
Adding Fuel .....	A-17
Diesel Exhaust Fluid Safety .....	A-17
Battery Safety .....	A-18
Tire Safety .....	A-18
Accumulator Safety .....	A-19
Safety Equipment .....	A-19
Hazard Lamps .....	A-19
Beacon Lamps .....	A-19
Backup Alarm .....	A-20
Parking Brake .....	A-20
Fire Extinguisher .....	A-20
Header Lift Cylinder Stop .....	A-20
Wheel Chocks .....	A-21
Safety and Information signs .....	A-22
Standard Combine .....	A-22
Straw Chopper .....	A-40
Adjustable Steering Axle .....	A-41
Region Specific Safety Decals .....	A-42

**SAFETY**

---

**NOTES**

## SAFETY ALERT SYMBOL

**FIG. 1:** The safety alert symbol means ATTENTION! BECOME ALERT! YOUR SAFETY IS INVOLVED!

Look for the safety alert symbol both in this manual and on safety signs on this machine. The safety alert symbol will direct your attention to information that involves your safety and the safety of others.

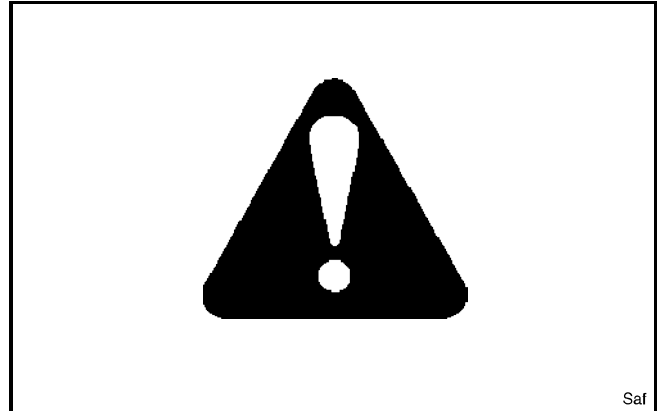



FIG. 1

## SAFETY MESSAGES

**FIG. 2:** The words DANGER, WARNING or CAUTION are used with the safety alert symbol. Learn to recognize these safety alerts and follow the recommended precautions and safety practices.

 **DANGER:** Indicates an imminently hazardous situation that, if not avoided, will result in DEATH OR VERY SERIOUS INJURY.

 **WARNING:** Indicates a potentially hazardous situation that, if not avoided, could result in DEATH OR SERIOUS INJURY.

 **CAUTION:** Indicates a potentially hazardous situation that, if not avoided, may result in MINOR INJURY.



FIG. 2

## INFORMATIONAL MESSAGES

The words IMPORTANT and NOTE are not related to personal safety, but are used to give additional information and tips for operating or servicing this equipment.

*IMPORTANT: Identifies special instructions or procedures which, if not strictly observed, could result in damage to or destruction of the machine, process, or its surroundings.*

*NOTE: Identifies points of particular interest for more efficient and convenient repair or operation.*

# SAFETY

---

## SAFETY SIGNS



**WARNING: Do not remove or obscure Danger, Warning or Caution signs. Replace any Danger, Warning or Caution signs that are not readable or are missing. Replacement signs are available from your dealer in the event of loss or damage. The actual location of the safety signs is illustrated at the end of this section.**

Keep signs clean by wiping off regularly. Use a cleaning solution if necessary.

If parts have been replaced or a used machine has been purchased, make sure all safety signs are in the correct location and can be read. See Safety Sign Location in this section for illustrations.

Replace any safety signs that can not be read or are missing. Clean the machine surface thoroughly with a cleaning solution before replacing signs. Replacement safety signs are available from your dealer.

## A WORD TO THE OPERATOR

**FIG. 3:** It is YOUR responsibility to read and understand the safety section in this manual and the manual for all attachments before operating this machine. Remember YOU are the key to safety. Good safety practices not only protect you, but also the people around you.

Study the features in this manual and make them a working part of your safety program. Keep in mind that this safety section is written only for this type of machine. Practice all other usual and customary safe working precautions, and above all **REMEMBER - SAFETY IS YOUR RESPONSIBILITY. YOU CAN PREVENT SERIOUS INJURY OR DEATH.**

This safety section is intended to point out some of the basic safety situations that may be encountered during the normal operation and maintenance of your machine. This section also suggests possible ways of dealing with these situations. This section is **NOT** a replacement for other safety practices featured in other sections of this manual.

Personal injury or death may result if these precautions are not followed.

Learn how to operate the machine and how to use the controls properly.

Do not let anyone operate the machine without instruction and training.

For your personal safety and the personal safety of others, follow all safety precautions and instructions found in the manuals and on safety signs affixed to the machine and all attachments. Use only approved attachments and equipment.

Make sure your machine has the correct equipment needed by the local regulations.



**WARNING:** An operator should not use alcohol or drugs which can affect their alertness or coordination. An operator on prescription or 'over the counter' drugs needs medical advice on whether or not they can properly operate machines.



**CAUTION:** If any attachments used on this equipment have a separate Operator Manual, see that manual for other important safety information.



**CAUTION:** See the engine Operation and Maintenance Manual for other important safety information.



**CAUTION:** See the combine Operator Manual for other important safety information.

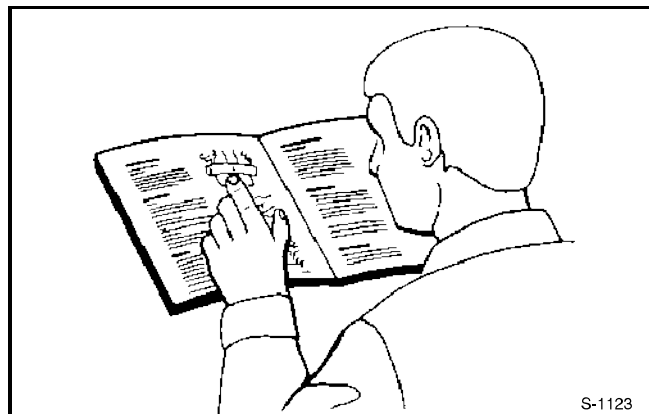

**FIG. 3**

# SAFETY

---

## OPERATOR MANUAL

This manual covers general safety practices for this machine. The Operator Manual must always be kept with the machine.

Right-hand and left-hand, as used in this manual, are determined by facing the direction the machine will travel when in use.

The photos, illustrations, and data used in this manual were current at the time of printing, but due to possible in-line production changes, your machine can vary slightly in detail. The manufacturer reserves the right to redesign and change the machine as necessary without notification.



**WARNING:** In some of the illustrations and photos used in this manual, shields or guards may have been removed for clarity. Never operate the machine with any shields or guards removed. If the removal of shields or guards is necessary to make a repair, they **MUST** be replaced before operation.

**FIG. 4:** The Operator Manual is stored in the holder (1) on the machine. After using the Operator Manual, return the manual to the storage location.

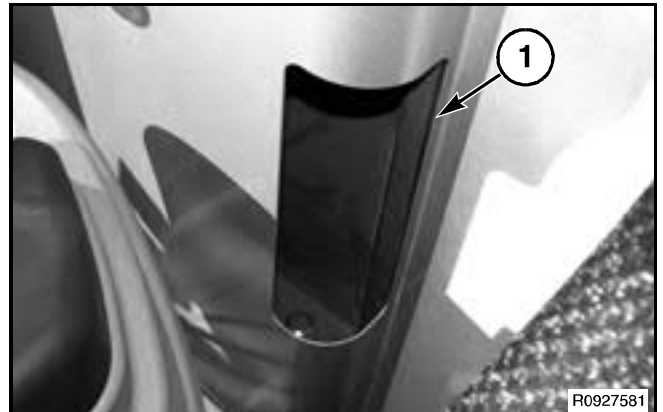

**FIG. 4**

## PREPARE FOR OPERATION

Read and understand all operating instructions and precautions in this manual before operating or servicing the machine.

Make sure you know and understand the positions and operations of all controls. Make certain all controls are in neutral and the parking brake is applied before starting the machine.

All equipment has a limit. Make sure you understand the speed, brakes, steering, stability, and load characteristics of this equipment before you start.

## OPERATION

### General Information

**FIG. 5:** When parking, park the machine on a solid level surface and lower the header to the ground. Put all controls in neutral and apply the parking brake. Stop the engine and take the key with you.



**WARNING:** Do not leave the machine unattended with the header raised. Lower the header fully before leaving the machine. A sudden loss of hydraulic pressure can cause the header to drop without warning.

Make sure the machine is in the proper operating condition according to the Operator Manual.

Always operate the machine with the control terminal turned on.

Do not dismount from moving machinery.

Stay off slopes too steep for operation.

Be aware of the size of the machine and have enough space available to allow for operation.

**FIG. 6:** Use extra care and reduce speed when operating on hillsides or near ditches or embankments especially with a full grain tank to avoid rollover. Travel speed must be such that complete control and machine stability is maintained at all times. Shift to a lower gear before descending a steep hill.

Regulate ground speed to field conditions, and maintain control at all times.

Do not dismount from moving machinery.

**FIG. 7:** Avoid contact with electrical power lines. Always put the grain tank unloader tube in the transport position and lower radio aerial before moving combine near electrical wires. Contact with electrical power lines can cause electrical shock, resulting in very serious injury or death.

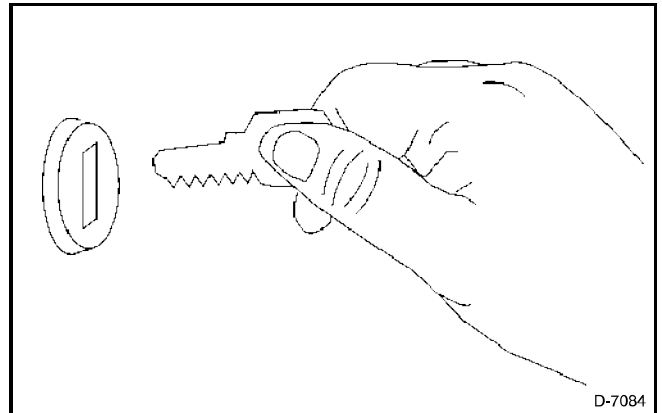

FIG. 5

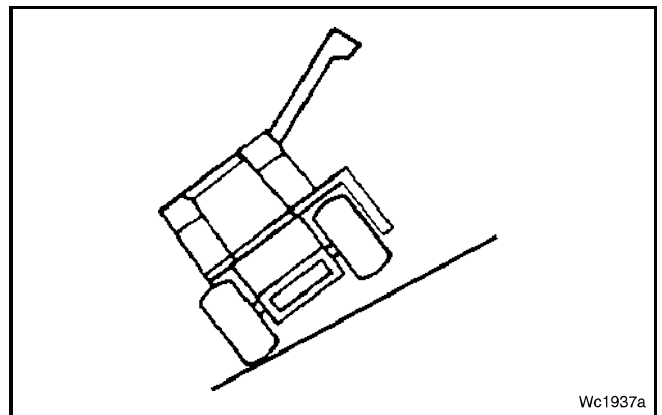

FIG. 6

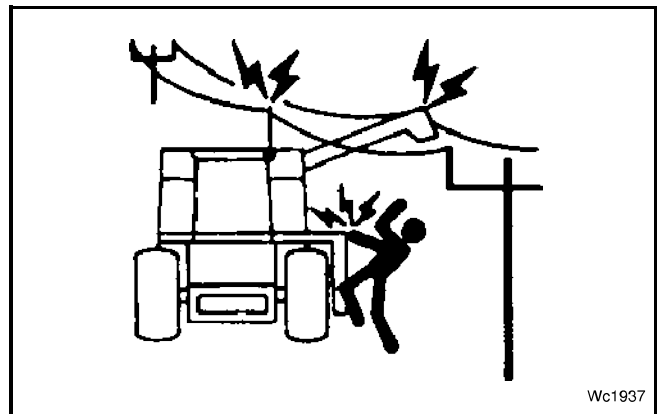
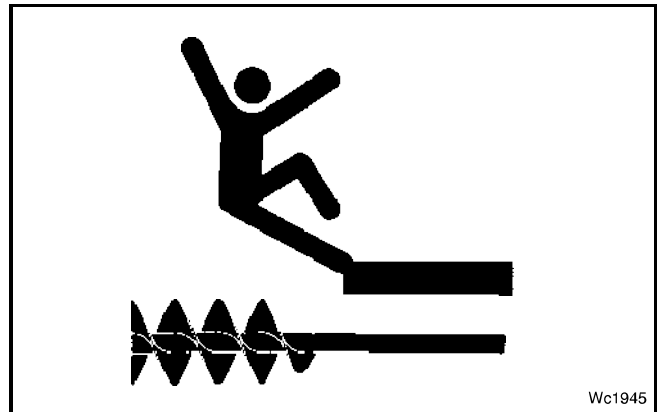

FIG. 7

## SAFETY

**FIG. 8:** Never allow anyone on any part of the combine or attachments except in the operator's seat and the instructional seat when the engine is running.

Do not get on or off the combine while the combine is moving.



**FIG. 8**

**FIG. 9:** Always shut off the engine, shift the transmission to neutral, set parking brake and remove the start key before leaving the operator's station or before permitting anyone to inspect, clean, lubricate, adjust or repair any part of the combine or attachments unless specifically instructed otherwise in this manual. Never leave combine unattended while the engine is operating.

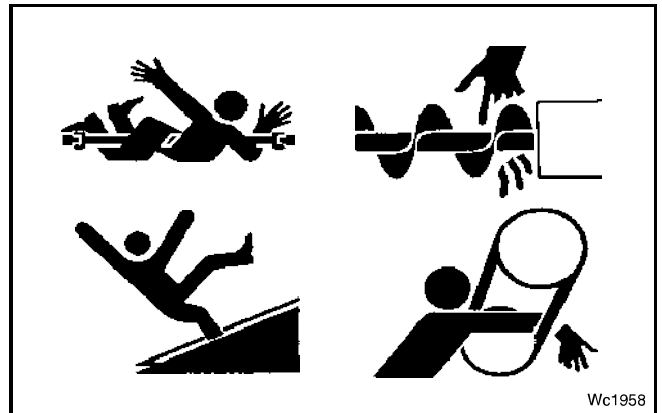
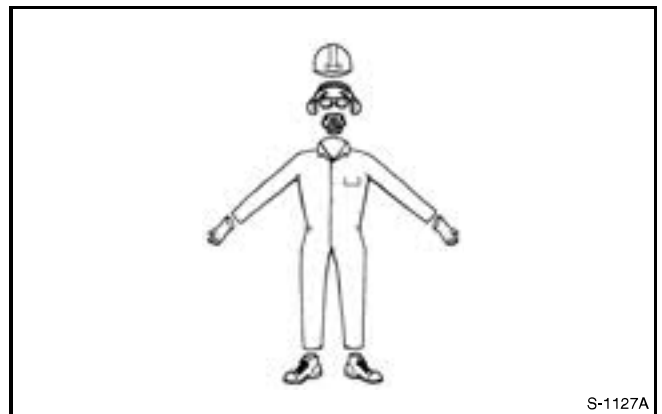

**FIG. 9**

### PPE (Personal Protection Equipment)

**FIG. 10:** Wear all personal protective equipment (PPE) and protective clothing issued to you or called for by job conditions and country/local regulations. PPE includes, but is not limited to, equipment to protect eyes, lungs, ears, head, hands and feet when operating, servicing or repairing equipment.

Always keep hands, feet, hair, and clothing away from moving parts. Do not wear loose clothing, jewelry, watches, or other items that could entangle in moving parts. Tie up long hair that can also entangle in moving parts.



**FIG. 10**

## Seat Instructions



**WARNING:** Never adjust the operator seat while the combine is moving. Always bring the combine to a complete stop before adjusting the operator seat.

**FIG. 11:** Securely fasten the seat belt before operating the machine. Always remain seated and have the seat belt fastened while operating the machine. Replace the seat belts when they become worn or broken.

Never wear a seat belt loosely or with slack in the belt system. Never wear the seat belt in a twisted condition or pinched between the seat structural members.

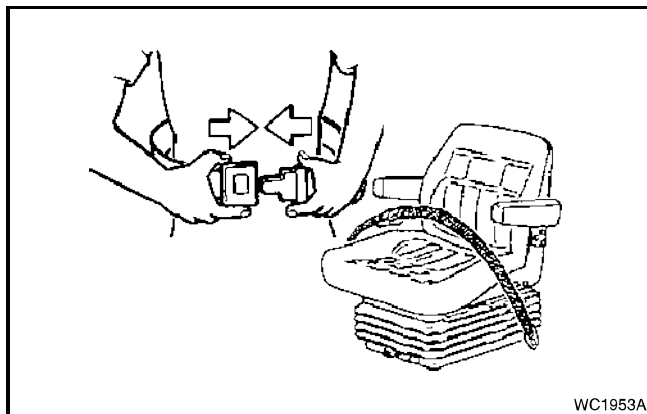

WC1953A

**FIG. 11**

**FIG. 12:** When using the instructor seat (1), securely fasten the seat belt (2). The instructor seat is to be used only to train new operators or diagnose a problem. The instructor seat is only intended for short periods of use. Extra riders, especially children, are not permitted on the machine.

When the instructor seat is used the machine must be driven at a slower speed and on level ground. Avoid quick starts, stops, and sharp turns. Avoid driving on highways or public roads.

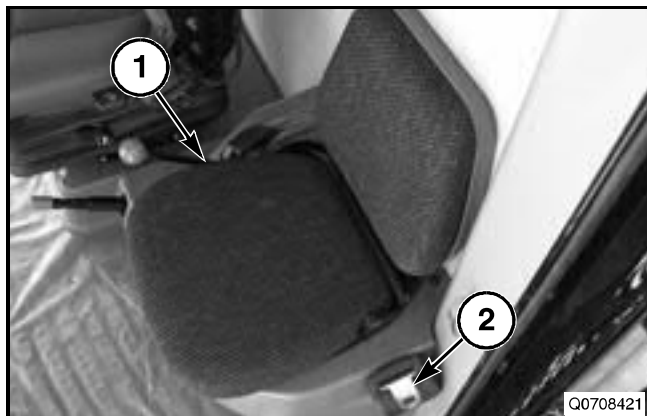

Q0708421

**FIG. 12**

## Shield and Guards

**FIG. 13:** All shields and guards must be in the correct operating position and in good condition.

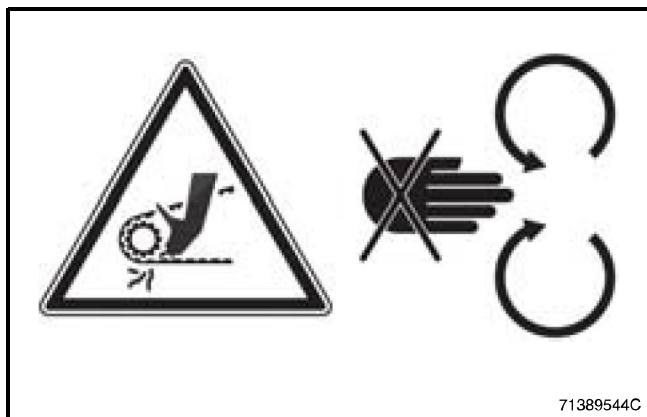

71389544C

**FIG. 13**

## SAFETY

**FIG. 14:** Do not operate the machine with the drive shaft shields open or removed. Entanglement in rotating drive shafts can cause serious injury or death. Stay clear of rotating components.

Make sure rotating guards turn freely.



WC1941

FIG. 14

### Exhaust Warning

**FIG. 15:** Never operate the engine in a closed building unless the exhaust is vented outside.

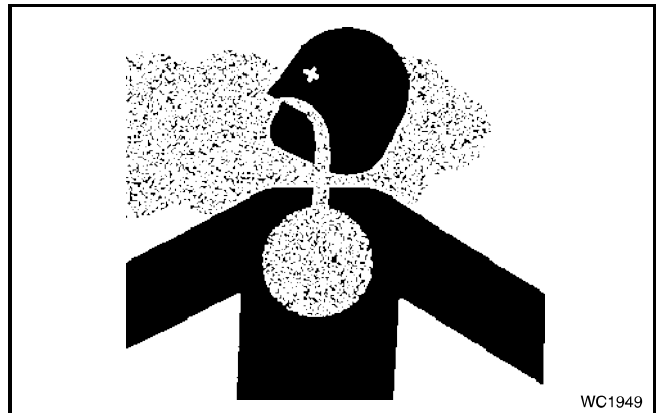

WC1949

FIG. 15

### Flying Debris

**FIG. 16:** Never stand near the machine during operation. Debris can be thrown from the machine during operation possibly resulting in injury.

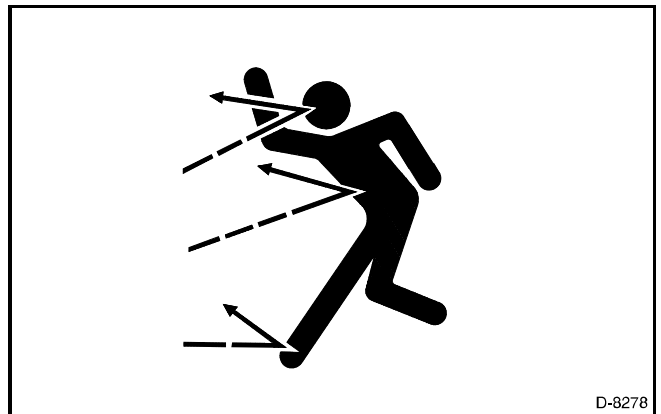

D-8278

FIG. 16

### Handrails

**FIG. 17:** Face the ladder and use the handrails when getting on or off the machine.



WC1940

FIG. 17

## TRAVEL ON PUBLIC ROADS

**FIG. 18:** Make sure you understand the speed, brakes, steering, stability, and load characteristics of this machine before you travel on public roads.

Use good judgment when traveling on public roads. Maintain complete control of the machine at all times. Never coast down hills.

The maximum speed of farm equipment is governed by local regulations. Adjust travel speed to maintain control at all times. See Specifications for the maximum speed for this machine.

Familiarize yourself with and obey all road regulations that apply to your machine. Consult your local law enforcement agency for local regulations regarding movement of farm equipment on public roads. Use headlights, flashing warning lights, taillights and turn signals, day and night, unless prohibited by local law.

Make sure all the flashers are operating prior to driving on the road. Make sure reflectors are correctly installed, in good condition, and wiped clean. Make sure the Slow Moving Vehicle (SMV) emblem is clean, visible, and correctly mounted on the rear of the machine.

Always travel with the header as low as possible. Do not drive with header up and the lift cylinder stops in the locked position. See Cylinder Stops in this section for more information.

Lock brake pedals together with the locking strap so that both front wheel brakes will be applied at the same time.

Be aware of other traffic on the road. Keep well over to your own side of the road and pull over, whenever possible, to let faster traffic pass.

Be aware of the overall width, length, height, and weight of the machine. Be careful when transporting the machine on narrow roads and across narrow bridges.

**FIG. 19:** Watch for overhead wires and other obstructions. Avoid contact with electrical power lines. Contact with electrical power lines can cause electrical shock, resulting in very serious injury or death.

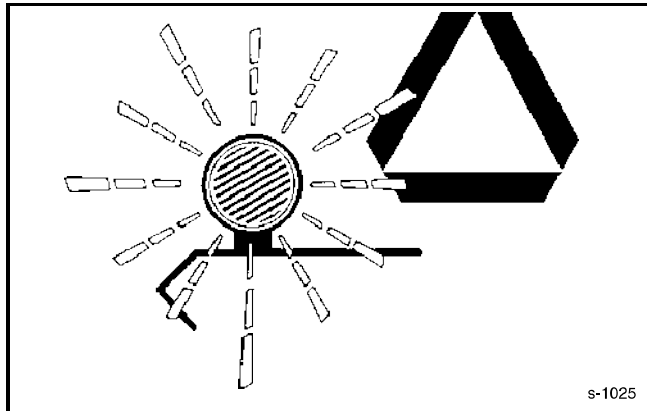

**FIG. 18**

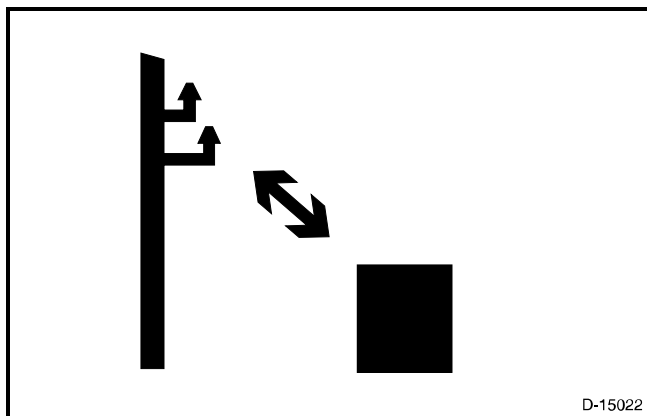

**FIG. 19**

# SAFETY

## MAINTENANCE

### General Information

**FIG. 20:** Before doing any unplugging, lubricating, servicing, cleaning, or adjusting:

- Park the machine on a solid level surface.
- Make sure the transmission is in gear and apply the parking brake.
- Stop the engine and take the key with you.
- Look and Listen! Make sure all moving parts have stopped.
- Put blocks in front of and behind the wheels of the machine before working on or under the machine.

Do not pull crop or any other object from the machine while the machine engine is running. Moving parts can pull you in faster than you can move away.

Check all nuts and capscrews periodically for tightness, especially wheel mounting hardware.

Do not attempt to service or adjust the machine until all moving parts have stopped.

After unplugging, lubricating, servicing, cleaning, or adjusting the machine make sure all tools and equipment have been removed.

Make sure electrical connectors are clean and free of dirt or grease before connecting.

Check for loose, broken, missing, or damaged parts. Make sure the machine is in good repair. Make sure all guards and shields are in position.

**FIG. 21:** Never service, check or adjust drive chains or belts while the engine is running.

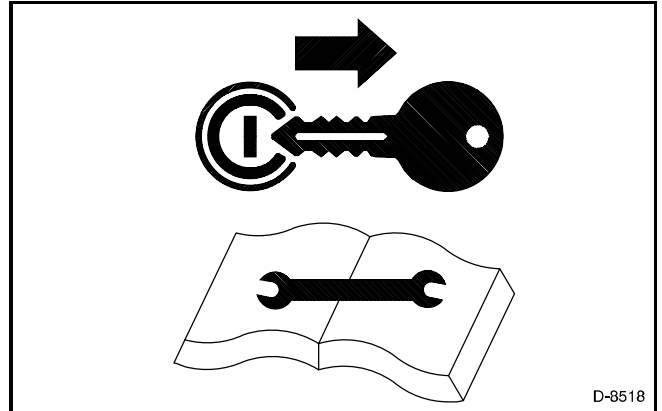

**FIG. 20**

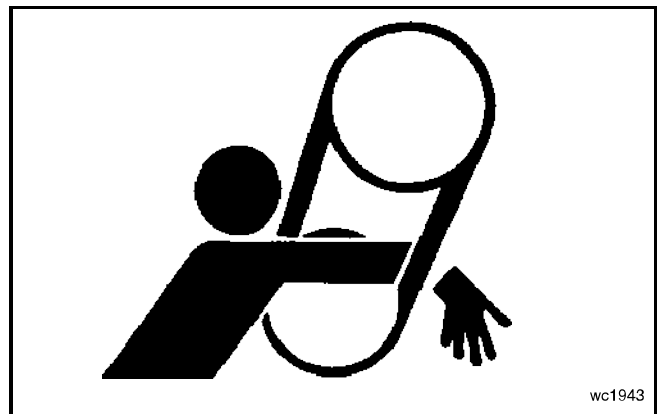

**FIG. 21**

**FIG. 22:** Do not operate the machine with the drive shafts shields open or removed. Entanglement in rotating drive shafts can cause serious injury or death.

Stay clear of rotating components.

Make sure rotating guards turn freely.

A loose yoke can slip off a shaft and result in injury to persons or damage to the machine.

When installing a quick disconnect yoke, the spring activated locking pins must slide freely and be seated in the groove on the shaft. Pull on the driveline to make sure the quick disconnect yoke can not be pulled off the shaft.



wc1941

FIG. 22

**FIG. 23:** When working on the machine, make sure the header and reel are lowered all the way.

When it is necessary for the header or the reel to be in the raised position, raise the header or reel all the way and engage the cylinder stops. See Cylinder Stops in this section for more information.



**WARNING:** Always install the header lift cylinder stops when working near the header. Do not rely on the hydraulic system to keep the header raised. A sudden loss of hydraulic pressure could cause the header to lower unexpectedly.

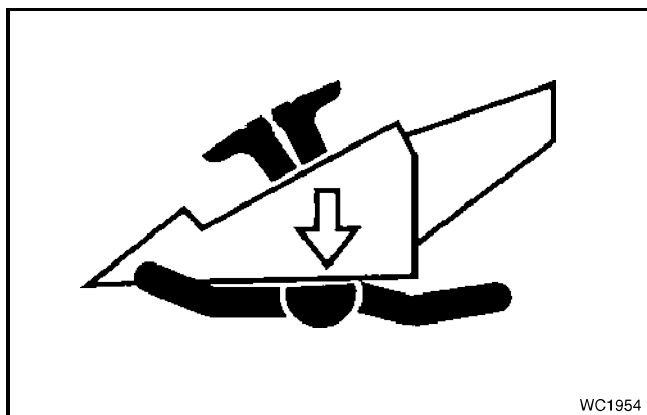

WC1954

FIG. 23

**FIG. 24:** Remove spilled oil, antifreeze or fuel immediately from operator's ladder and platform and other access areas.

Keep all access areas clean and free of obstructions.



Wc1939

FIG. 24



**Suggest:**

**For more complete manuals. Please go to the home page.**

**<https://www.ebooklibonline.com>**

**If the above button click is invalid. Please download this document first, and then click the above link to download the complete manual.**

**Thank you so much for reading**

## SAFETY

### Fire Prevention and First Aid

**FIG. 25:** Be prepared for emergencies.

Keep a first aid kit handy for treatment of minor cuts and scratches.

Due to the nature of the crops this machine will operate in, the risk of fire is of concern.

Always carry one or more fire extinguishers of the correct type. Check fire extinguishers regularly as instructed by the manufacturer. Make sure fire extinguishers are properly charged and in operating condition.

Use a water type fire extinguisher or other water source for a fire in crop.

Know how to operate the fire extinguisher before operating the machine.

For fires involving anything other than crop, such as oil or electrical components, use a dry chemical fire extinguisher with an ABC rating.

Mount fire extinguishers within easy reach of where fires can occur.

Frequently remove accumulated crop material from the machine and check for overheated components. Check the machine daily for any noises that are not normal. Such noises could indicate a failed component that can cause excess heat.

If any flame cutting, welding, or arc welding is to be done on the machine or attachments, make sure to clear any crop material or debris from around the area. Make sure the area below the work area is clear of any flammable material as falling molten metal or sparks can ignite the material.

**FIG. 26:** If fire occurs stand upwind and away from smoke from the fire.

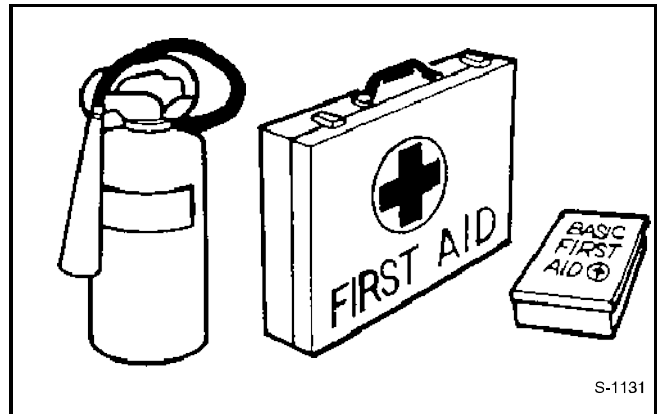

**FIG. 25**

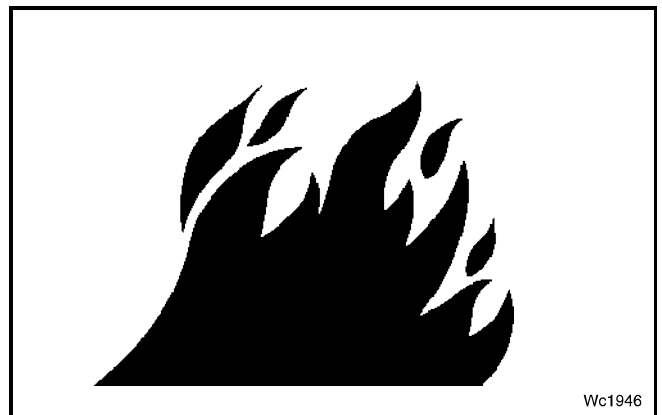

**FIG. 26**

## Checking for High Pressure Leaks

**FIG. 27:** Fluid leaking from the hydraulic system or the fuel injection system under high pressure can be very hard to see. The fluid can go into the skin causing serious injury.

Fluid injected into the skin must be surgically removed within a few hours. If not removed immediately, serious infection or reaction can develop. Go immediately to a doctor who knows about this type of injury.



**FIG. 27**

**FIG. 28:** Use a piece of cardboard or wood to search for possible leaks. Do not use your bare hand. Wear leather gloves for hand protection and safety goggles for eye protection.

Relieve all pressure before loosening any hydraulic lines. Relieve the pressure by lowering raised equipment, shutting off accumulator valve, if equipped, and shutting off the engine. Tighten all connections securely before applying pressure.

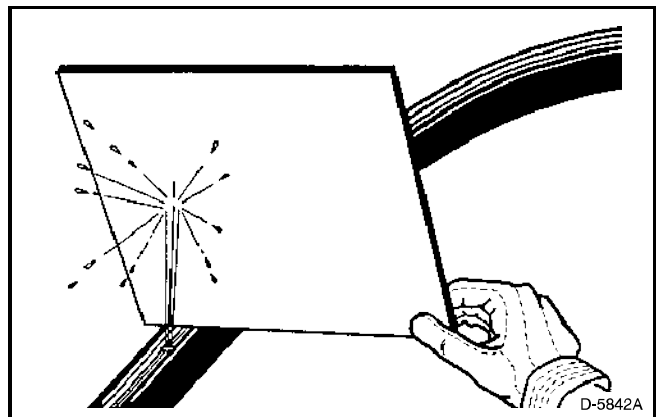

**FIG. 28**

## Engine Safety



**CAUTION:** See the engine Instruction Manual for other important engine safety information.

**FIG. 29:** Make sure all shields, guards and access doors are in place and properly closed before starting the engine.

Start the engine from the operator's seat only. Make sure all controls are in neutral and drives are disengaged.

Make sure all bystanders are clear of the machine before starting the engine.

Do not bypass the neutral start system. The neutral start system is designed to prevent starting the machine in gear. Any manual override of this system can cause death or serious injury.

Never connect booster cables to the starter terminals or short across the starter terminals.

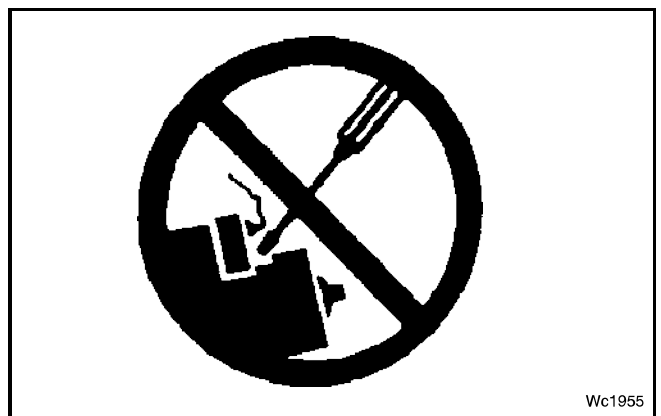

**FIG. 29**

**<https://www.ebooklibonline.com>**

Hello dear friend!

Thank you very much for reading.

Enter the link into your browser.

The full manual is available for immediate download.

**<https://www.ebooklibonline.com>**