

**COMBINE**

**OPERATOR MANUAL**

**FENDT™  
9300R/9350R CE  
Combine**



**FENDT™**  
**9300R/9350R CE**  
**700735941 F Rev.**  
**9300R - Serial No. HUC6E101 and Up /**  
**AGCF9300RAHCE6101 and Up**  
**9350R - Serial No. HUCE7101 and Up /**  
**AGCF9350RAHCE7101 and Up**  
**CONTENTS**

SAFETY .....	A-1
GENERAL INFORMATION .....	B-1
OPERATION .....	C-1
ADJUSTMENTS .....	D-1
LUBRICATION AND MAINTENANCE .....	E-1
TROUBLESHOOTING .....	F-1
SPECIFICATIONS .....	G-1
ACCESSORIES AND OPTIONS .....	H-1
ASSEMBLY .....	J-1
INDEX .....	K-1

# CONTENTS

---

## NOTES

**<https://www.ebooklibonline.com>**

Hello dear friend!

Thank you very much for reading.

Enter the link into your browser.

The full manual is available for immediate download.

**<https://www.ebooklibonline.com>**

---

## SAFETY

### Contents

Safety Alert Symbol .....	A-3
Safety Messages .....	A-3
Informational Messages .....	A-3
Safety Signs .....	A-4
A Word To The Operator .....	A-5
Operator Manual .....	A-6
Prepare For Operation .....	A-6
Operation .....	A-7
General Information .....	A-7
PPE (Personal Protection Equipment) .....	A-8
Seat Instructions .....	A-9
Shield and Guards .....	A-9
Exhaust Warning .....	A-10
Flying Debris .....	A-10
Handrails .....	A-10
Travel On Public Roads .....	A-11
Maintenance .....	A-12
General Information .....	A-12
Fire Prevention and First Aid .....	A-14
Checking for High Pressure Leaks .....	A-14
Engine Safety .....	A-15
Adding Fuel .....	A-16
Battery Safety .....	A-17
Tire Safety .....	A-18
Accumulator Safety .....	A-18
Safety Equipment .....	A-19
Header Lift Cylinder Stop .....	A-19
Wheel Chocks .....	A-19
Hazard Lamps .....	A-20
Beacon Lamps .....	A-20
Backup Alarm .....	A-20
Parking Brake .....	A-20
Fire Extinguisher .....	A-21
Shields and Latches .....	A-21
Feeder House .....	A-21
Side Shields .....	A-22
Mud Shields .....	A-23
Clean Grain Elevator Drive Shield .....	A-23
Feeder Opening Cover .....	A-23
Safety and Information signs .....	A-24
Safety Signs .....	A-27
Information Signs .....	A-37

**SAFETY**

---

**NOTES**

## SAFETY ALERT SYMBOL

**FIG. 1:** The safety alert symbol means ATTENTION! BECOME ALERT! YOUR SAFETY IS INVOLVED!

Look for the safety alert symbol both in this manual and on safety signs on this machine. The safety alert symbol will direct your attention to information that involves your safety and the safety of others.

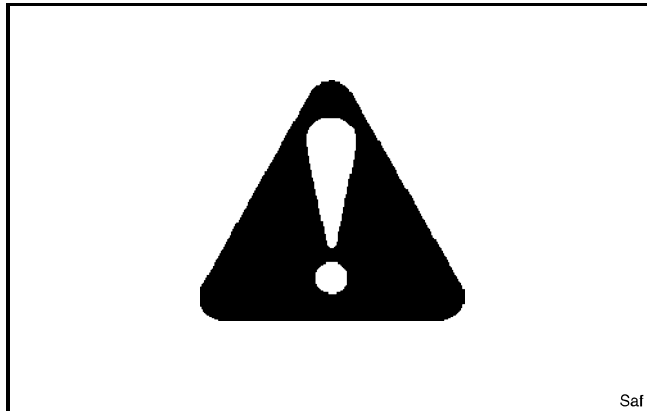



FIG. 1

## SAFETY MESSAGES

**FIG. 2:** The words DANGER, WARNING or CAUTION are used with the safety alert symbol. Learn to recognize these safety alerts and follow the recommended precautions and safety practices.

 **DANGER:** Indicates an imminently hazardous situation that, if not avoided, will result in DEATH OR VERY SERIOUS INJURY.

 **WARNING:** Indicates a potentially hazardous situation that, if not avoided, could result in DEATH OR SERIOUS INJURY.

 **CAUTION:** Indicates a potentially hazardous situation that, if not avoided, may result in MINOR INJURY.



FIG. 2

## INFORMATIONAL MESSAGES

The words IMPORTANT and NOTE are not related to personal safety, but are used to give additional information and tips for operating or servicing this equipment.

*IMPORTANT: Identifies special instructions or procedures which, if not strictly observed, could result in damage to or destruction of the machine, process, or its surroundings.*

*NOTE: Identifies points of particular interest for more efficient and convenient repair or operation.*

# SAFETY

---

## SAFETY SIGNS



**WARNING: Do not remove or obscure Danger, Warning or Caution signs. Replace any Danger, Warning or Caution signs that are not readable or are missing. Replacement signs are available from your dealer in the event of loss or damage. The actual location of the safety signs is illustrated at the end of this section.**

Keep signs clean by wiping off regularly. Use a cleaning solution if necessary.

If parts have been replaced or a used machine has been purchased, make sure all safety signs are in the correct location and can be read. See Safety Sign Location in this section for illustrations.

Replace any safety signs that can not be read or are missing. Clean the machine surface thoroughly with a cleaning solution before replacing signs. Replacement safety signs are available from your dealer.

## A WORD TO THE OPERATOR

**FIG. 3:** It is YOUR responsibility to read and understand the safety section in this manual and the manual for all attachments before operating this machine. Remember YOU are the key to safety. Good safety practices not only protect you, but also the people around you.

Study the features in this manual and make them a working part of your safety program. Keep in mind that this safety section is written only for this type of machine. Practice all other usual and customary safe working precautions, and above all **REMEMBER - SAFETY IS YOUR RESPONSIBILITY. YOU CAN PREVENT SERIOUS INJURY OR DEATH.**

This safety section is intended to point out some of the basic safety situations that may be encountered during the normal operation and maintenance of your machine. This section also suggests possible ways of dealing with these situations. This section is **NOT** a replacement for other safety practices featured in other sections of this manual.

Personal injury or death may result if these precautions are not followed.

Learn how to operate the machine and how to use the controls properly.

Do not let anyone operate the machine without instruction and training.

For your personal safety and the personal safety of others, follow all safety precautions and instructions found in the manuals and on safety signs affixed to the machine and all attachments. Use only approved attachments and equipment.

Make sure your machine has the correct equipment needed by the local regulations.



**WARNING:** An operator should not use alcohol or drugs which can affect their alertness or coordination. An operator on prescription or 'over the counter' drugs needs medical advice on whether or not they can properly operate machines.



**CAUTION:** If any attachments used on this equipment have a separate Operator Manual, see that manual for other important safety information.



**CAUTION:** See the engine Operation and Maintenance Manual for other important safety information.



**CAUTION:** See the combine Operator Manual for other important safety information.

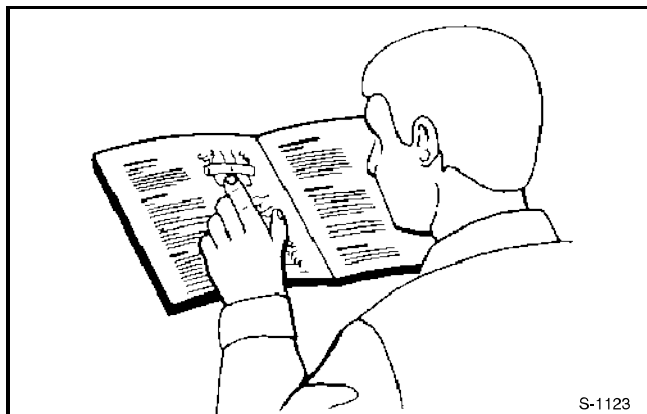

**FIG. 3**

S-1123

# SAFETY

---

## OPERATOR MANUAL

This manual covers general safety practices for this machine. The Operator Manual must always be kept with the machine.

Right-hand and left-hand, as used in this manual, are determined by facing the direction the machine will travel when in use.

The photos, illustrations, and data used in this manual were current at the time of printing, but due to possible in-line production changes, your machine can vary slightly in detail. The manufacturer reserves the right to redesign and change the machine as necessary without notification.



**WARNING:** In some of the illustrations and photos used in this manual, shields or guards may have been removed for clarity. Never operate the machine with any shields or guards removed. If the removal of shields or guards is necessary to make a repair, they **MUST** be replaced before operation.

**FIG. 4:** The Operator Manual is stored in the holder (1) on the machine. After using the Operator Manual, return the manual to the storage location.



**FIG. 4**

## PREPARE FOR OPERATION

Read and understand all operating instructions and precautions in this manual before operating or servicing the machine.

Make sure you know and understand the positions and operations of all controls. Make certain all controls are in neutral and the parking brake is applied before starting the machine.

All equipment has a limit. Make sure you understand the speed, brakes, steering, stability, and load characteristics of this equipment before you start.

## OPERATION

### General Information

**FIG. 5:** When parking, park the machine on a solid level surface and lower the header to the ground. Put all controls in neutral and apply the parking brake. Stop the engine and take the key with you.



**WARNING:** Do not leave the machine unattended with the header raised. Lower the header fully before leaving the machine. A sudden loss of hydraulic pressure can cause the header to drop without warning.

Make sure the machine is in the proper operating condition according to the Operator Manual.

Always operate the machine with the control console turned on.

Do not dismount from moving machinery.

Stay off slopes too steep for operation.

Be aware of the size of the machine and have enough space available to allow for operation.

**FIG. 6:** Use extra care and reduce speed when operating on hillsides or near ditches or embankments especially with a full grain tank to avoid rollover. Travel speed must be such that complete control and machine stability is maintained at all times. Shift to a lower gear before descending a steep hill.

Regulate ground speed to field conditions, and maintain control at all times.

Do not dismount from moving machinery.

**FIG. 7:** Avoid contact with electrical power lines. Always put the grain tank unloader tube in the transport position and lower radio aerial before moving combine near electrical wires. Contact with electrical power lines can cause electrical shock, resulting in very serious injury or death.

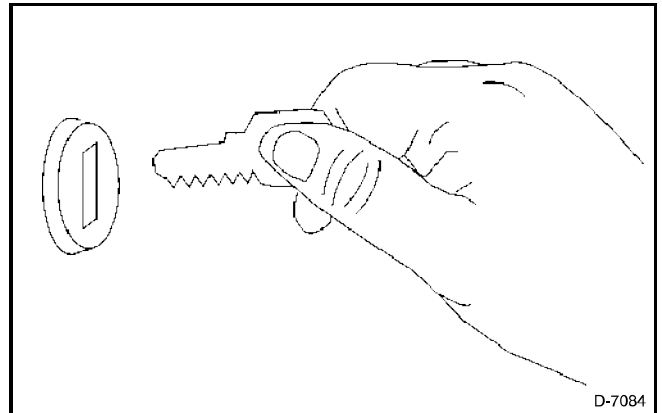

FIG. 5

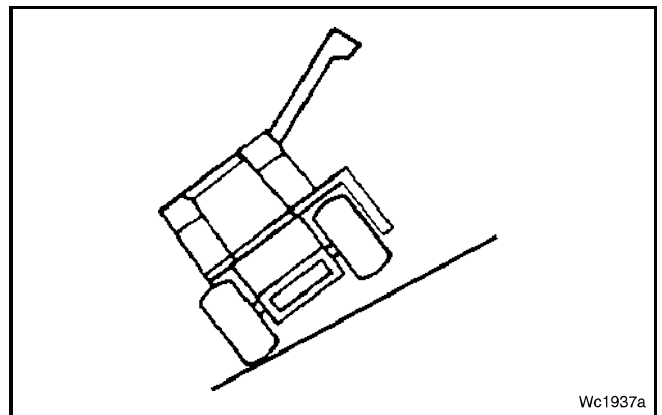

FIG. 6

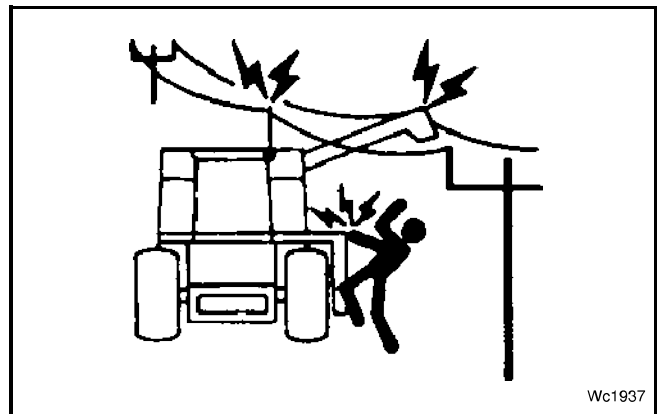
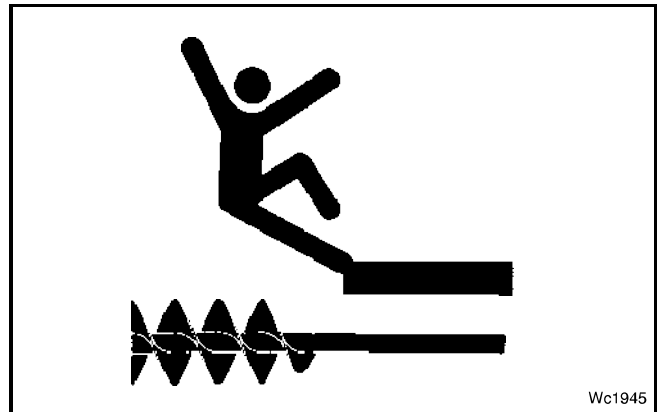

FIG. 7

## SAFETY

**FIG. 8:** Never allow anyone on any part of the combine or attachments except in the operator's seat and the instructional seat when the engine is running.

Do not get on or off the combine while the combine is moving.



**FIG. 8**

**FIG. 9:** Always shut off the engine, shift the transmission to neutral, set parking brake and remove the start key before leaving the operator's station or before permitting anyone to inspect, clean, lubricate, adjust or repair any part of the combine or attachments unless specifically instructed otherwise in this manual. Never leave combine unattended while the engine is operating.

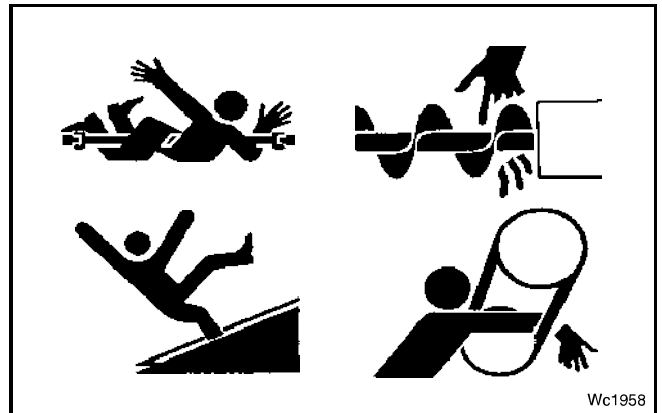
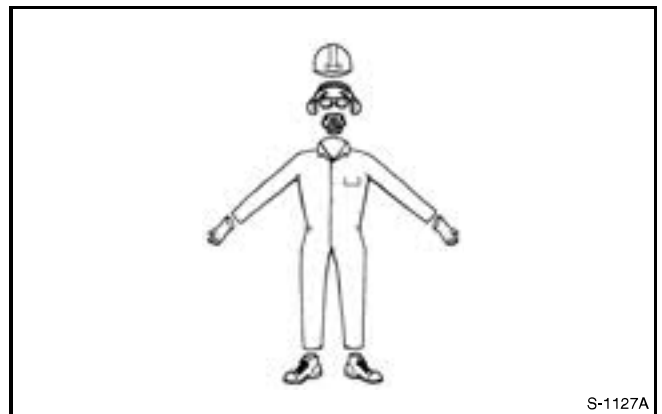

**FIG. 9**

### PPE (Personal Protection Equipment)

**FIG. 10:** Wear all personal protective equipment (PPE) and protective clothing issued to you or called for by job conditions and country/local regulations. PPE includes, but is not limited to, equipment to protect eyes, lungs, ears, head, hands and feet when operating, servicing or repairing equipment.

Always keep hands, feet, hair, and clothing away from moving parts. Do not wear loose clothing, jewelry, watches, or other items that could entangle in moving parts. Tie up long hair that can also entangle in moving parts.



**FIG. 10**

**Seat Instructions**

**FIG. 11:** Securely fasten the seat belt before operating the machine. Always remain seated and have the seat belt fastened while operating the machine. Replace the seat belts when they become worn or broken.

Never wear a seat belt loosely or with slack in the belt system. Never wear the seat belt in a twisted condition or pinched between the seat structural members.

When using the instructional seat, if equipped, securely fasten the seat belt. The instructional seat is to be used only to train new operators or diagnose a problem. The instructional seat is only intended for short periods of use. Extra riders, especially children, are not permitted on the machine.

When the instructional seat is used the machine must be driven at a slower speed and on level ground. Avoid quick starts, stops, and sharp turns. Avoid driving on highways or public roads.

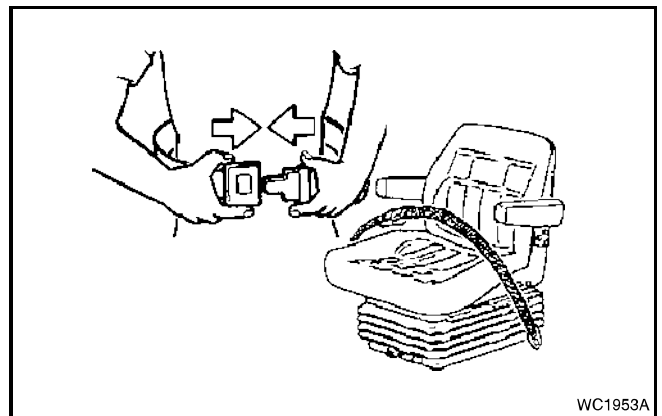
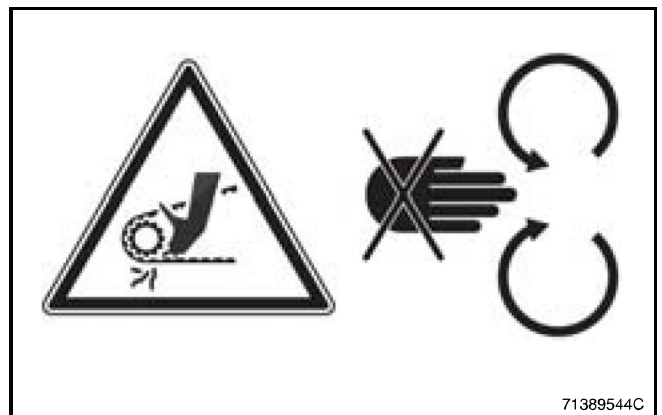

**FIG. 11**

WC1953A

**Shield and Guards**

**FIG. 12:** All shields and guards must be in the correct operating position and in good condition.



**FIG. 12**

71389544C

**FIG. 13:** Do not operate the machine with the drive shaft shields open or removed. Entanglement in rotating drive shafts can cause serious injury or death. Stay clear of rotating components.

Make sure rotating guards turn freely.



**FIG. 13**

WC1941

## SAFETY

### Exhaust Warning

**FIG. 14:** Never operate the engine in a closed building unless the exhaust is vented outside.

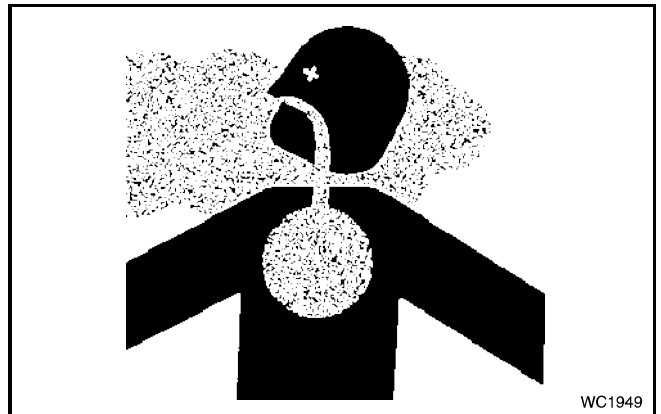

**FIG. 14**

### Flying Debris

**FIG. 15:** Never stand near the machine during operation. Debris can be thrown from the machine during operation possibly resulting in injury.

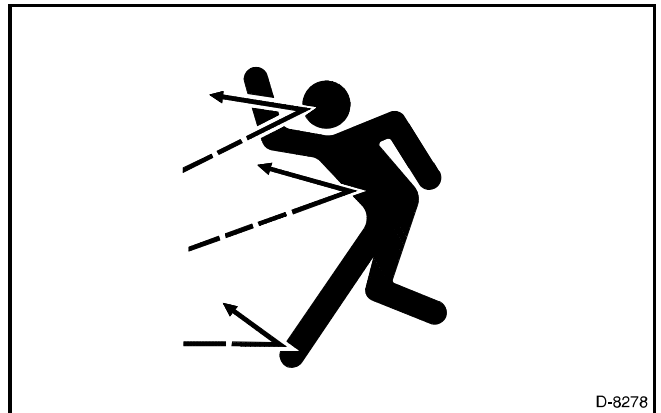

**FIG. 15**

### Handrails

**FIG. 16:** Face the ladder and use the handrails when getting on or off the machine.



**FIG. 16**



**Suggest:**

**For more complete manuals. Please go to the home page.**

**<https://www.ebooklibonline.com>**

**If the above button click is invalid. Please download this document first, and then click the above link to download the complete manual.**

**Thank you so much for reading**

## TRAVEL ON PUBLIC ROADS

**FIG. 17:** Make sure you understand the speed, brakes, steering, stability, and load characteristics of this machine before you travel on public roads.

Use good judgment when traveling on public roads. Maintain complete control of the machine at all times. Never coast down hills.

The maximum speed of farm equipment is governed by local regulations. Adjust travel speed to maintain control at all times. See Specifications for the maximum speed for this machine.

Familiarize yourself with and obey all road regulations that apply to your machine. Consult your local law enforcement agency for local regulations regarding movement of farm equipment on public roads. Use headlights, flashing warning lights, taillights and turn signals, day and night, unless prohibited by local law.

Make sure all the flashers are operating prior to driving on the road. Make sure reflectors are correctly installed, in good condition, and wiped clean. Make sure the Slow Moving Vehicle (SMV) emblem is clean, visible, and correctly mounted on the rear of the machine.

Always travel with the header as low as possible. Do not drive with header up and the lift cylinder stops in the locked position. See Cylinder Stops in this section for more information.

Lock brake pedals together with the locking strap so that both front wheel brakes will be applied at the same time.

Be aware of other traffic on the road. Keep well over to your own side of the road and pull over, whenever possible, to let faster traffic pass.

Be aware of the overall width, length, height, and weight of the machine. Be careful when transporting the machine on narrow roads and across narrow bridges.

**FIG. 18:** Watch for overhead wires and other obstructions. Avoid contact with electrical power lines. Contact with electrical power lines can cause electrical shock, resulting in very serious injury or death.

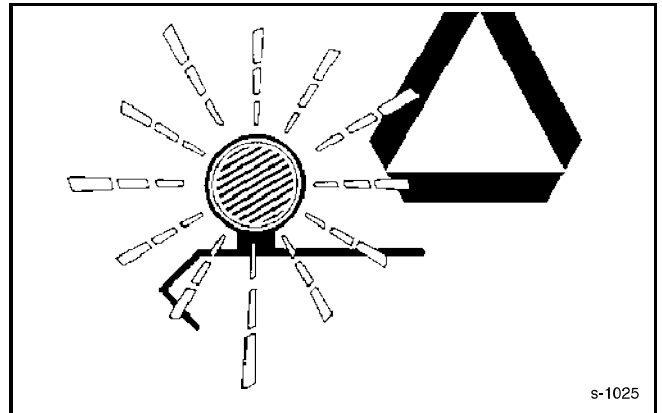

**FIG. 17**

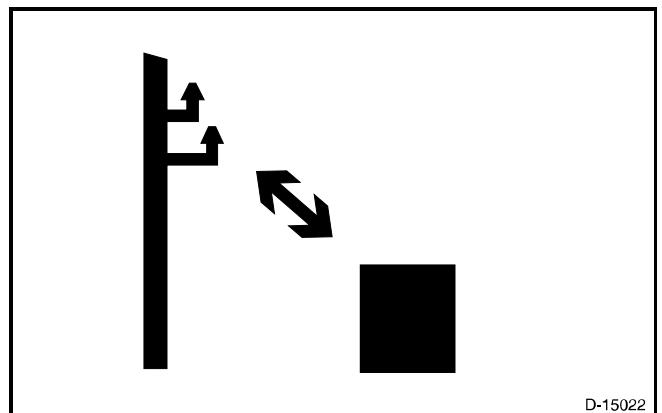

**FIG. 18**

s-1025

D-15022

# SAFETY

## MAINTENANCE

### General Information

**FIG. 19:** Before doing any unplugging, lubricating, servicing, cleaning, or adjusting:

- Park the machine on a solid level surface.
- Make sure the transmission is in gear and apply the parking brake.
- Turn off the control console, if equipped.
- Stop the engine and take the key with you.
- Look and Listen! Make sure all moving parts have stopped.
- Put blocks in front of and behind the wheels of the machine before working on or under the machine.

Do not pull crop or any other object from the machine while the machine engine is running. Moving parts can pull you in faster than you can move away.

Check all nuts and bolts periodically for tightness, especially wheel mounting hardware.

Do not attempt to service or adjust the machine until all moving parts have stopped.

After unplugging, lubricating, servicing, cleaning, or adjusting the machine make sure all tools and equipment have been removed.

Make sure electrical connectors are clean and free of dirt or grease before connecting.

Check for loose, broken, missing, or damaged parts. Make sure the machine is in good repair. Make sure all guards and shields are in position.

**FIG. 20:** Never service, check or adjust drive chains or belts while the engine is running.

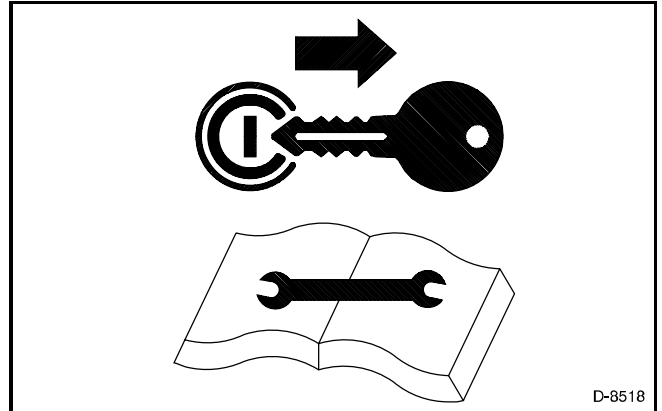

**FIG. 19**



**FIG. 20**

**<https://www.ebooklibonline.com>**

Hello dear friend!

Thank you very much for reading.

Enter the link into your browser.

The full manual is available for immediate download.

**<https://www.ebooklibonline.com>**