

## FENDT 700 Vario S4

### FENDT 714 Vario S4

738 .. 01001-

### FENDT 716 Vario S4

739 .. 01001-

### FENDT 718 Vario S4

740 .. 01001-

### FENDT 720 Vario S4

741 .. 01001-

### FENDT 722 Vario S4

742 .. 01001-

### FENDT 724 Vario S4

743 .. 01001-



# TABLE OF CONTENT

- Tractor ..... 1
- Gearbox ..... 2
- Engine ..... 3
- Front axle ..... 4
- Steering ..... 5
- Air-conditioning system ..... 6
- Cab ..... 7
- Power lift ..... 8
- Compressed air system ..... 9
- Electrical system ..... 10
- Hydraulic pump installation ..... 11
- Hydraulic equipment ..... 12
- Electronics ..... 13
- Service ..... 14

# 1. Tractor

<b>1.1 General</b>	<b>1-3</b>
1.1.1 Notes on documentation	1-3
1.1.2 Safety briefing and measures	1-4
1.1.3 Importance of and position of the safety decals	1-7
1.1.4 Note on hydraulics	1-18
1.1.5 Assignment table FENDT T types to the EU Type Approval Number	1-19
1.1.6 Change wheels	1-20
1.1.7 Location of the identification plates	1-22
1.1.8 Biodegradable hydraulic oil	1-25
1.1.9 Tightening torque for screws with a galvanized surface	1-26
1.1.10 Tightening torque for screws and bolts with VDA coating	1-27
<b>1.2 Technical specification</b>	<b>1-29</b>
1.2.1 Technical data: 0000 general	1-29
1.2.2 Transmission	1-30
1.2.3 Technical specification: Engine	1-37
1.2.4 Front axle	1-45
1.2.5 Steering	1-47
1.2.6 Air conditioning / Cab / EPC control valve	1-47
1.2.7 Compressed air system / Electrical system / Front power lift	1-48
1.2.8 Hydraulic equipment	1-49
<b>1.3 Fault code tables</b>	<b>1-53</b>
1.3.1 Note on the fault code table	1-53
1.3.2 Confirming, calling up, deleting fault codes	1-53
1.3.3 Fault code 00.0.00	1-55
1.3.4 Fault code 01.0.00	1-59
1.3.5 Error code 02.1.00	1-64
1.3.6 Error code 03.1.00	1-66
1.3.7 Fault code 04.1.00	1-68
1.3.8 Fault code 05.1.00	1-81
1.3.9 Fault code 06.1.00	1-86
1.3.10 Fault code 07.1.00	1-91
1.3.11 Fault code 08.1.00	1-93
1.3.12 Fault code 09.1.00	1-99
1.3.13 Fault code 0A.1.00	1-104
1.3.14 Fault code 0B.1.00	1-124
1.3.15 Error code 0D.1.00	1-127
1.3.16 Fault code 0E.1.00	1-130
1.3.17 Error code 0F.1.00	1-135
1.3.18 Fault code 10.1.00	1-138
1.3.19 Error code 11.1.00	1-140
1.3.20 Fault code 14.1.00	1-141
1.3.21 Fault code 15.1.00	1-145
1.3.22 Fault code 17.1.00	1-146
1.3.23 Fault code 18/01/2000	1-147
1.3.24 Fault code 1D.1.00	1-150
1.3.25 Fault code 1F.1.00	1-162
1.3.26 Error code 20.1.00	1-163
1.3.27 Fault messages: manual air conditioning system	1-168
1.3.28 Calibration fault codes	1-169
<b>1.4 Component position</b>	<b>1-181</b>

**<https://www.ebooklibonline.com>**

Hello dear friend!

Thank you very much for reading.

Enter the link into your browser.

The full manual is available for immediate download.

**<https://www.ebooklibonline.com>**

1.4.1	Electrical/electronic components - A	1-181
1.4.2	Electrical/electronic components - B	1-187
1.4.3	Electrical/electronic components - E	1-199
1.4.4	Electrical/electronic components - F	1-208
1.4.5	Electrical/electronic components - G	1-209
1.4.6	Electrical/electronic components - H	1-209
1.4.7	Electrical/electronic components - K	1-210
1.4.8	Electrical/electronic components - M	1-212
1.4.9	Electrical/electronic components - R	1-216
1.4.10	Electrical/electronic components - S	1-217
1.4.11	Electrical/electronic components - U	1-224
1.4.12	Electrical/electronic components - X	1-225
1.4.13	Electrical/electronic components - Y	1-269
1.4.14	Hydraulic components	1-277
<b>1.5</b>	<b>Settings and calibration</b>	<b>1-293</b>
1.5.1	General information on calibration	1-293
1.5.2	Calibration code 8001 8002 (Rear EPC)	1-297
1.5.3	Calibration code 9001 9002 (Front EPC)	1-303
1.5.4	Calibration code 1001 (crossgate lever)	1-309
1.5.5	Calibration code (1003 ... 1006) (linear module)	1-314
1.5.6	Calibration code 7666 (front axle suspension)	1-318
1.5.7	Calibration code 2401 (steering angle sensor)	1-320
1.5.8	Calibration code 2403 (VarioGuide steering valve)	1-330
1.5.9	Calibration code 6034 (rear PTO clutch)	1-333
1.5.10	Calibration code 7034 (front PTO clutch)	1-336
1.5.11	Calibration code 4001 (clutch pedal)	1-338
1.5.12	Calibration code 4002 (hand throttle)	1-341
1.5.13	Calibration code 4003 (travel speed range selector)	1-343
1.5.14	Calibration code 4005 (foot throttle/accelerator pedal)	1-346
1.5.15	Calibration code 4007 (transmission ratio characteristic)	1-349
1.5.16	Calibration code 4009 (turbo-clutch function)	1-353
1.5.17	Calibration code 4010 (accelerator pedal resolution)	1-356
1.5.18	Calibrating the heater valve (no code)	1-359
1.5.19	Calibration of the heater valve — manual air conditioning system	1-360
1.5.20	Calibrating speed display and tire circumference	1-361
1.5.21	Calibration fault codes	1-363

---

## 1.1 General

---

### 1.1.1 Notes on documentation

---

To ensure that the information is structured in a user-friendly manner, the service documentation is divided into the operator's manual and the workshop manual.

The operator's manual includes a general description as well as instructions for all necessary maintenance work.

Knowledge of the owner's manual is essential to understand the workshop manual. This is particularly important for safety instructions. The workshop manual describes repairs to assemblies and components that will require more effort and suitably qualified specialists to carry out.

#### **Note**

This workshop manual provides notes for trained technicians to maintain our tractors. Read and observe the information in this documentation. This will help you prevent accidents and safeguard the manufacturer's warranty.

The respective accident prevention rules as well as other generally recognized safety and occupational health rules must be observed.

The tractor is built solely for the purpose defined by the implement manufacturer. Any other type of use is considered unauthorized. The manufacturer bears no liability for any damage resulting from improper use. The user bears this risk alone. Intended use includes maintaining operating, service and maintenance conditions as specified by the manufacturer.

Operation, maintenance and repair of the tractor may only be carried out by people who are familiar with this equipment and aware of the associated dangers. Ensure that this documentation is available to and understood by everyone involved in operation, maintenance and repair. Not observing this documentation can lead to faults, damage and personal injury, for which the manufacturer assumes no liability. The prerequisite for the tractor being correctly serviced and maintained is the perfect condition and availability of all necessary equipment, standard tools and general workshop equipment as well as special tools. Special tools must only be used where absolutely necessary. The tools are displayed where they need to be used in each case.

The machine must be maintained according to its proper use. Always replace parts with genuine FENDT spare parts! When ordering parts, please provide the chassis number as per the most up-to-date spare parts documentation.

Only parts approved by the manufacturer for that specific purpose may be used for any alterations. The manufacturer will not accept liability for any damage resulting from unauthorized modifications to the tractor. Non-compliance invalidates the warranty!

Workshops should also refer to documentation on maintenance work and technical data. Once maintenance is complete, take a test drive to ensure the vehicle's correct operation and road safety.

We reserve the right to make design changes in light of technical developments.

#### **Notes on repairs**

The assembly/disassembly instructions shown correspond to the design status at the time the workshop manual was drawn up.

Further technical development of the product and additions related to different versions may require alternative working processes that do not pose too many difficulties to trained and qualified specialists.

These assembly/disassembly instructions shall be invalidated upon issue of the next version of this document.

## 1.1.2 Safety briefing and measures

### Important notes on work safety

The statutory accident prevention regulations (available from professional associations or specialist shops) must be observed. These depend on the operating site, operating mode and fuels and lubricants used. Additional protective measures dependent on the respective procedures are specified in the corresponding repair guidelines and highlighted.

### Safety instructions

This handbook uses the following safety tips:



**DANGER:**

**This symbol, together with the word DANGER, means there is an immediate risk of danger that must be avoided. Otherwise there is a risk of DEATH OR VERY SERIOUS INJURIES.**



**WARNING:**

**This symbol, together with the word WARNING, means there is a potential danger that must be avoided. Otherwise there is a risk of DEATH OR SERIOUS INJURIES.**



**CAUTION:**

**This symbol, together with the word CAUTION, means there is a potential danger that must be avoided. Otherwise there is a risk of MINOR INJURIES.**

### Please observe the following when carrying out maintenance or service work to the tractor:

Only the documentation associated with the vehicle (workshop manual and operator's manual) must be used to complete any pending work.

#### 1. General

- Only briefed personnel may operate the tractor or carry out maintenance work.
- Only use qualified specialists to carry out repairs or service work.
- Nobody may be in the cab while work is being carried out under the jacked-up tractor.
- Relieve pressure on the pressure lines for implements.
- All people should keep clear of a lifted, unsecured load (e.g. tilted cab etc.).
- Never open or remove any safety devices while the engine is running.
- Pressurized fluids (fuel or hydraulic oil) escaping under high pressure can penetrate the skin and cause severe injuries. If this should occur, seek medical advice immediately to avoid the risk of serious infection.
- Keep at a safe distance from hot areas.
- Pressure accumulator and connected pipes are highly pressurized. Only remove and repair in accordance with instructions provided in the workshop manual.
- To avoid eye injury, do not look directly at the surface of the activated radar sensor.
- Dispose of oil, fuel and filters properly!
- Specialist knowledge and special fitting tools are required to fit tires.
- Run the tractor for a short time, then retighten all wheel nuts and bolts and check them regularly. For correct torque values refer to TECHNICAL DATA.
- Before working on the electrical system, always remove the earth strap from the battery. Observe the following when carrying out electric welding. Before carrying out welding work on tractor or mounted implements, ensure that both battery terminals are disconnected. Attach the welding appliance's earth terminal as close to the welding spot as possible.
- Caution is required when dealing with brake fluid and battery acid as these are toxic and corrosive!
- Only use genuine FENDT spare parts.

## 2. Working on the front-axle suspension



**DANGER:** The front axle suspension pressure lines between the central control block and the suspension cylinder and the pipe of the cased pressure accumulator are under high pressure even when the engine is switched off and the suspension is lowered/locked.

**Risk of injury and death! Material damage is possible.**

**Prior to each repair and after releasing or opening hydraulic lines in this area, the pressure must be released manually!**

**NOTE:** The "Lock suspension/lower suspension" command has no effect!

**To release pressure:**



**CAUTION:** The tractor body raises and lowers when the pressure is relieved.

**Risk of injury!**

**There must be no people present in the area around the tractor body when relieving the pressure!**

- Turn thumb screw to **Y013** - Lower suspension solenoid valve, body may lower
- Turn thumb screw to **Y014** - Raise suspension solenoid valve, rebound accumulator will be relieved

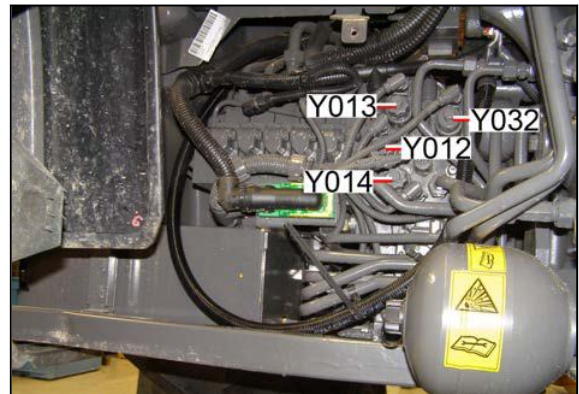

Fig. 1

**Check:**

As the oil temperature rises, the emptying accumulator will make a flowing sound (barely audible in winter).

## 3. Working on the brake system



**DANGER:** The brake system lines remain under pressure even when the engine has been switched off!

**Compressed air escapes at high pressure!**

**Before each repair to the brake system or when removing the cab, the pressure must be relieved manually.**

**To release pressure:**

1. Engine must be off
2. Secure the tractor to prevent it from rolling away.
3. Actuate the foot brake at least 5x

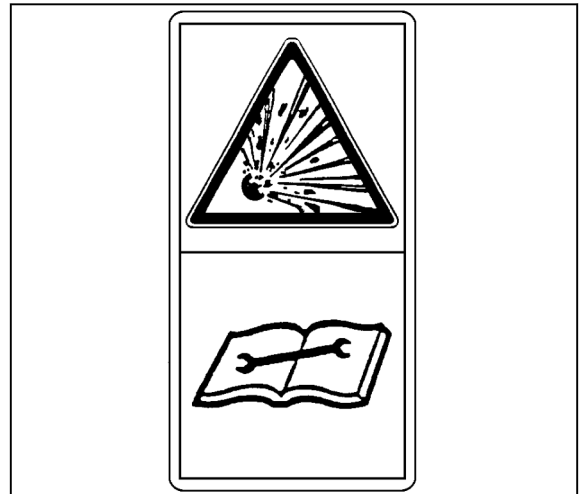

Fig. 2

**General notes:**

- Always check the brakes before driving.
- Adjustments and repairs to the brake system must be carried out in specialist workshops or by approved brake repair technicians.
- It must not be possible to brake individual wheels when driving (lock pedals)!

#### 4. Working on the engine

- After switching the engine off, wait 30 seconds before carrying out any work on the fuel system.
- Only start the engine once all safety guards have been attached and nobody is standing in the danger area.
- Never let the engine run in enclosed spaces with no exhaust gas suction system.
- Cleaning, maintenance and repair work may only be carried out once the engine is switched off and secured to prevent it starting.
- Injection pipes and high-pressure lines must not be deformed.
- Any damaged injection pipe or high-pressure line must be replaced.
- Do not loosen any injection pipes for high-pressure fuel lines while the engine is running.
- Before carrying out checks to the running engine, always perform a visual check of all high-pressure components. Suitable protective clothing (e.g. protective goggles) should be worn while doing this. Leaks indicate potential sources of danger for workshop personnel.
- In the event of leaks to the high-pressure fuel system, always remain out of range of any possible fuel spray to avoid serious injury.
- Even when no leaks to the high-pressure fuel system can be detected, workshop personnel should avoid the immediate danger area and wear suitable protective clothing (such as protective goggles) when carrying out checks to the running engine and during the first test run.
- Smoking is forbidden while carrying out work to the fuel system.
- Do not work in the proximity of sparks or naked flames.
- Never disconnect an injector while the engine is running.

#### 5. Working on the PTO

- Always switch off the engine before fitting or removing the drive shaft. PTO in "0" position!
- When working on the PTO, allow no-one in the vicinity of the rotating PTO or drive shaft.
- Make sure drive shaft and PTO are equipped with shield pipes and protective funnels.
- After deactivating the PTO, it is possible that parts on the mounted implement may continue to run. In this case, do not get too close to the implement. Work may only be carried out to the implement when nothing is moving!
- When the drive shaft is removed, cover the PTO shaft with its protective cap.
- Nobody should be in the cab when installing and removing the drive shaft.

Operation of controls for the tractor and mounted implements by people in the cab, especially children, may result in severe or fatal injury.

#### 6. Working on the front loader

- Before undertaking maintenance work, lower the front loader to the ground, switch off the engine and remove the ignition key.
- In the event of a collapsed pipe rupture feature, support the load before starting repair work, and slowly retract the cylinder.
- Check hydraulic hoses and pipes for signs of damage and aging regularly and replace with genuine spare parts in good time.
- Following installation and repairs, operate the tractor for a short time, then retighten all nuts and bolts and check them regularly.
- Retighten eccentric bolt for front loader attachment, if necessary.

#### Disposal

The work described in the operator's manual and workshop manual includes replacing parts, fuel and lubricants. These renewed parts/fuel/lubricants must be stored, transported and disposed of in accordance with regulations. The repairing workshop bears responsibility for this. The disposal encompasses the recycling and final disposal of parts, fuel and lubricants with recycling having the higher priority. Details about disposal and monitoring are specified in regional, national and international laws and directives, the observation of which is the sole responsibility of the repairing workshops.

---

**1.1.3 Importance of and position of the safety decals**

---

The position and importance of the safety decals on the vehicle are explained below.

**Position:** Left C-pillar, cab interior

743.810.090.050



**WARNING:**  
**Serious injury or death caused by inadequate compliance with the Operator's Manual**  
**Inadequate compliance with the Operator's Manual can cause damage, injuries and in serious cases death. Before operation, make sure that this Operator's Manual is available on the vehicle in legible form. The owner is responsible for providing adequate training to those personnel who are entrusted with the vehicle and for ensuring they are familiar with the instructions in the Operator's Manual and, where applicable, the service manual. The same applies to those persons who are both owner and operator. Observe all safety notes and instructions, and execute all measures correctly and completely at all times.**



**Position:** Left B-pillar, cab interior

743.810.090.100



**WARNING:**  
**Serious injury or death caused by being ejected from the cab**  
**When driving, an improperly closed door can open. Vehicle occupants not strapped in or not properly strapped in can be ejected from the vehicle and run over. This can cause serious injury and even death. Make sure that, during travel, all vehicle passengers are properly strapped in at all times.**



**Position:** Left C-pillar, cab interior

743.810.090.060



**WARNING:**  
**Serious injury or death caused by being ejected from the cab**  
**If the vehicle tips over, the door can open. Vehicle occupants not strapped in or not properly strapped in can be ejected from the vehicle. This can cause serious injury and even death. Make sure that, during travel, all vehicle passengers are properly strapped in at all times.**



**Position:** Left B-pillar, cab interior

743.810.090.130



**WARNING:**  
**Serious injury or even death caused by critical driving situations due to the operator's seat lateral suspension being activated**  
**When the lateral suspension is activated, critical driving situations can occur during road travel if the vehicle becomes difficult to operate. This can cause serious injury and even death. Deactivate the lateral suspension when travelling on public roads. When not on public roads, do not drive too fast when the lateral suspension is activated.**



**Position:** Left-hand B-pillar, cab interior and left-hand rear of tractor, under the cab

743.810.090.090



**WARNING:**  
**Serious injury or death caused by running over persons when leaving the vehicle**  
**The vehicle can start rolling due to non-activation of the parking brake before leaving the vehicle, in which persons in the area of the vehicle can be caught and run over. Activate the parking brake before leaving the vehicle and remove the vehicle key.**



**Position:** Left B-pillar, cab interior

743.810.090.150



**DANGER:**  
**Danger of inhaling hazardous substances. Refer to Operator's Manual for safety instructions and the correct settings for the ventilation system.**



**Position:** Under engine cover, next to coolant expansion tank

743.500.410.080



**DANGER:**  
**Scalding caused by hot coolant vapor**  
After the vehicle has been operated, the cooling circuit contains pressurized, hot coolant. When the coolant reservoir or circuit is opened, the coolant escapes in the form of hot vapor and can cause scalding if allowed to come into direct contact with the skin.  
Before opening the coolant reservoir or circuit, switch off the engine and allow sufficient time for the coolant to cool down.  
The maintenance manual contains all important information.



**Position:** Right-hand side of tractor, at exhaust as well as left and right of radiator

743.500.410.060



**DANGER:**  
**Severe burns caused by contact with hot surfaces**  
Components heated up by engine operation or external influences, e.g. engine parts, the exhaust system, hydraulic system etc. can cause severe burns on contact.  
Maintain an adequate distance from hot components. If work has to be performed on these components, allow them to cool down first. Wear safety gloves if necessary.



**Position:** Battery box, right side of vehicle

743.500.410.030



**WARNING:**  
**Burns caused by explosive flames and chemical burns caused by battery electrolyte**  
**Direct contact with escaping battery electrolyte causes chemical burns to the eyes. Escaping battery electrolyte can react with the ambient air to form an explosive mixture.**  
**Avoid direct contact with battery electrolyte and always wear gloves and goggles when working with an open battery. During such work, do not use naked flames and avoid spark formation.**  
**The Operator's Manual contains all important information.**

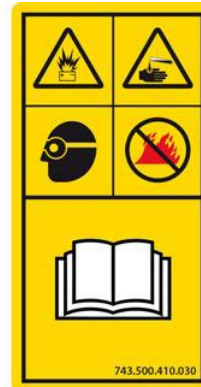

**Position:** Right and left at radiator

743.500.410.070



**DANGER:**  
**Danger of body parts being torn off!**  
**Switch the engine off and remove the ignition key before maintenance and repair work.**



**Position:** Right and left at radiator

743.500.410.050



**DANGER:**  
**Danger of body parts being crushed or pulled into the machine!**  
**Switch the engine off and remove the ignition key before maintenance and repair work.**



**Position:** On hydraulic pressure accumulator

X655.505.700.000



**WARNING:**

**High-pressure injection-related injury caused by an escaping high-pressure jet**

If screw connections are opened improperly or hydraulic lines are removed incorrectly, hydraulic fluid under high pressure will escape in a jet even if the engine is switched off. This can cause serious injuries, especially to the eyes. The high-pressure jet can also cause serious injury to the body and limbs and the hydraulic fluid can penetrate the skin and cause blood poisoning.

Make sure that the hydraulic circuit is opened only by appropriately trained maintenance personnel. Never open screw connections on the hydraulic system or remove hydraulic lines when the engine is running or when the engine is starting up. Release the pressure when the engine is switched off. Always wear gloves and goggles to open the hydraulic circuit.



**Position:** Left-hand side of engine, at the front above front axle and left/right rear mudguard

743.810.090.030



**WARNING:**

**Serious injuries or death during incorrect work on the PTO.**

When working on the PTO, a rotating PTO can cause crushing, shearing and impact injuries.

Before removing safety devices and performing other work on the PTO, remove the ignition key and make sure that the PTO cannot be reactivated until a safe state has been restored. The maintenance manual contains all important information.



**Position:** Left-hand side of engine, at the front above front axle and left/right rear mudguard, rear  
737.500.410.030



**WARNING:**  
**Serious injury caused by incorrect power lift actuation**  
 When the rear power lift is actuated via the external pressure switch, any persons standing between the vehicle and the implement can be crushed as the implement is raised and positioned.  
**Make sure, when actuating the external pressure switch of the rear power lift, that nobody is standing between the vehicle and the implement.**



**Position:** Cover of PTO stub  
743.500.410.110



**DANGER:**  
**Danger of slipping and of serious injury. Do not use the PTO cover or rear linkage components as a step.**



**Position:** Cover of PTO stub  
743.500.410.020



**DANGER:**  
**Danger due to parts being flung around if transmission shafts or implements are installed improperly. Observe the safety instructions in the Operator's Manual.**

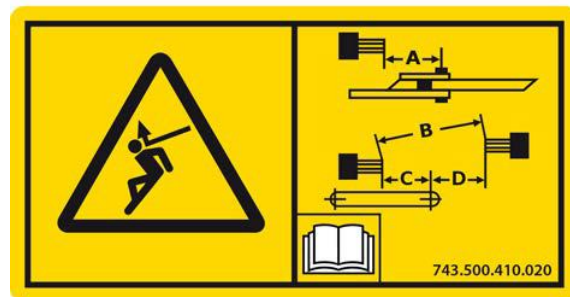

**Position:** Left and right at the front axle

743.500.410.040



**DANGER:**  
Danger of body parts being crushed.  
Switch the engine off and remove the ignition key before maintenance and repair work.

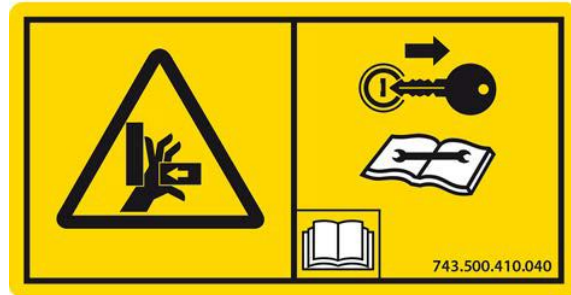

**Position:** Left / right rear left mudguard, rear

743.810.090.040



**WARNING:**  
Serious injury or death caused by the vehicle tipping over  
Exceeding the maximum permissible hitch load on the towing hitch can result in critical driving conditions through the front wheels being raised. In the worst case, the vehicle can tip over. This can cause serious injury and even death.  
Always respect the maximum hitch load indicated on the sign plate of your vehicle.

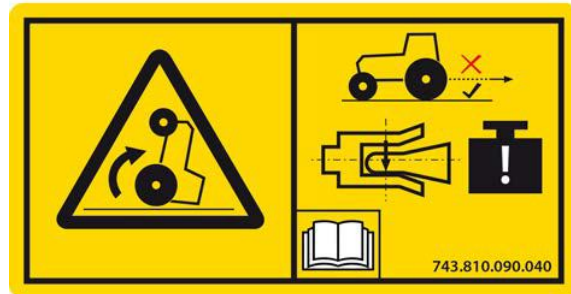

**Position:** Above the hydraulic couplers at rear and on right side of tractor, next to hydraulic couplers in the centre

737.960.100.160

**NOTE:**

*Do not use the hydraulic connectors simultaneously. Do not use the hydraulic valves for the front loader with the hydraulic couplers in the rear when a front loader is attached.*

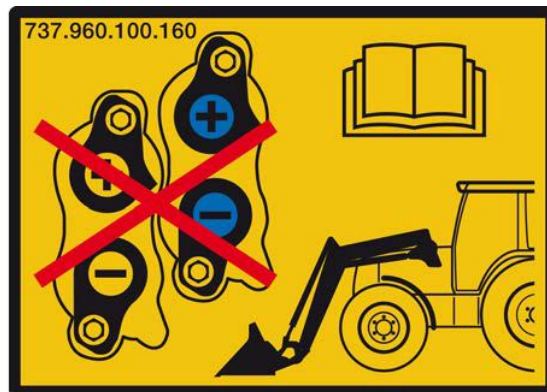

**Position:** Left/right bottom link lift rod, rear

835.870.030.060



**CAUTION:**

**Damage to the bottom link lift rod due to incorrect bottom link floatation. If the lift rod bolt is incorrectly set to floatation, the lift rod can become damaged.**

**Always set the lift rod bolt to the "top" position if a bottom link floatation is not required to operate the implement.**

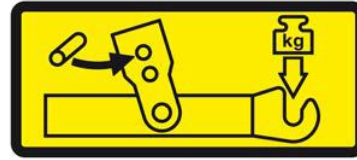

835.870.030.060

**Position:** Below the rear window and on the roof hatch, cab interior

530.811.090.040

**NOTE:**

*Emergency exit from the cab when the cab door will not open*

*If the cab door will not open, use the roof hatch or the rear window as an emergency exit.*



530.811.090.040

**Position:** Right C-pillar, cab interior

743.810.090.110



**CAUTION:**

**Damage caused by incorrect electric welding**

**Improper welding can damage electronic components and interfere with their operation.**

**Always disconnect the battery before welding. Position the welder ground clamp as close as possible to the welding point. Pay attention to temperature-sensitive parts.**

**The maintenance manual contains all important information.**



743.810.090.110

**Position:** Right C-pillar, cab interior

743.810.090.080



**CAUTION:**  
**Damage caused by incorrect towing**  
**Towing in a gear position other than**  
**the towing position will damage the**  
**gearbox.**  
**Before towing, ensure that the**  
**gearbox is in the towing position.**  
**The Operator's Manual contains all**  
**important information.**



**Position:** Front of vehicle, on air-conditioning condenser

650.503.410.360

**NOTE:**  
*System contains the prescribed air conditioning medium R134a*  
*Use only the legally prescribed air conditioning medium R134a (1,1,1,2-Tetrafluoroethane).*



**Position:** Right mudguard, cab interior

743.810.090.070



**CAUTION:**  
**Damage caused by incorrect towing**  
**To prevent transmission damage being**  
**caused by incorrect towing, always**  
**observe all important information in**  
**the towing instructions in the**  
**Operator's Manual.**  
**Specifically, the vehicle should be**  
**towed only over a limited distance and**  
**at a speed of below 10 km/h or 6 mph.**

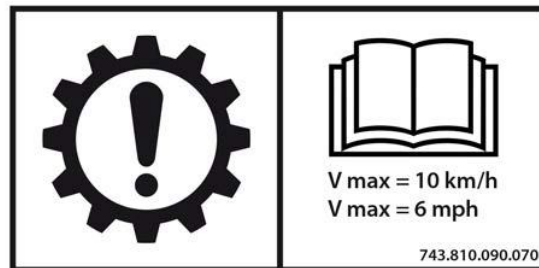

**Position:** PTO stub shaft protection

743.500.410.010

**NOTE:** *Note the speed and rotational direction of the PTO. Refer to the Operator's Manual when mounting or connecting implements.*

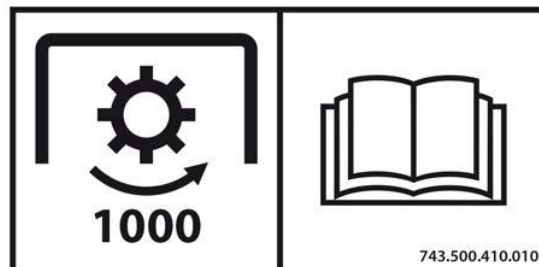

**Position:** Roof lining, centre right

743.810.090.120

**NOTE:**

*Recalibration of the tachograph after a tire change  
Always calibrate the tachograph after a rear tire  
change. Failure to do so can cause incorrect  
tachograph recordings.*

*The Operator's Manual contains all important  
information.*

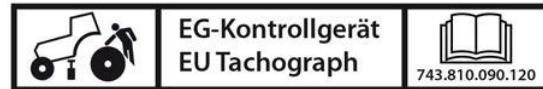

**Position:** Rear of vehicle, left-hand side of ball holder

743.500.410.130

**NOTE:** *Refer to the Operator's Manual when  
mounting implements on the rear power lift.*



**Position:** Rear of tractor, above hydraulic couplings

743.500.410.100

**NOTE:** *Switch lever for rear power lift, single-acting  
or double-acting*

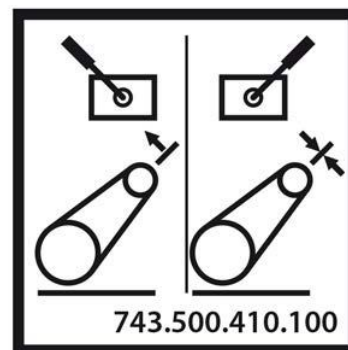

**Position:** Engine, on the valve cover

411.201.010.010

**NOTE:**

*Do not re-tighten the cylinder head bolts  
During initial setup and after repair work, the  
cylinder head bolts are tightened in accordance with  
the relevant instruction sheet and must not be re-  
tightened.*

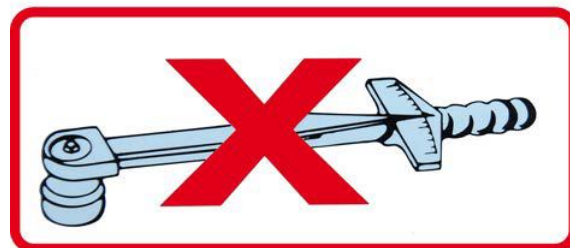

411.201.010.010

**Position:** Left side of engine, at the front above the front axle

438.500.410.010

Front lubrication points, see maintenance instructions

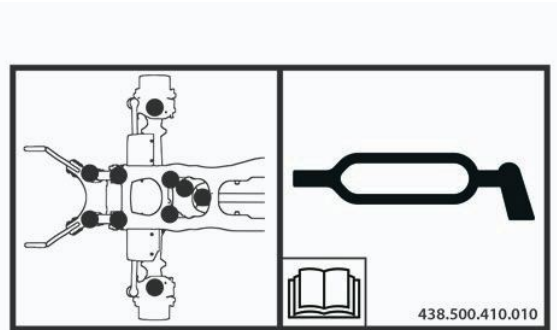

**Position:** On the right at the back on inside of mudguard

954.500.410.030

Rear lubrication points, see maintenance instructions

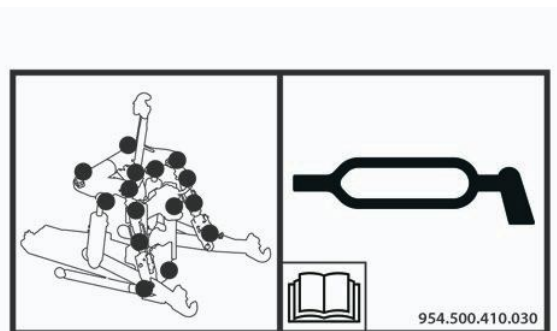

**Position:** Left entrance step

743.810.090.240

Jack points, see maintenance instructions

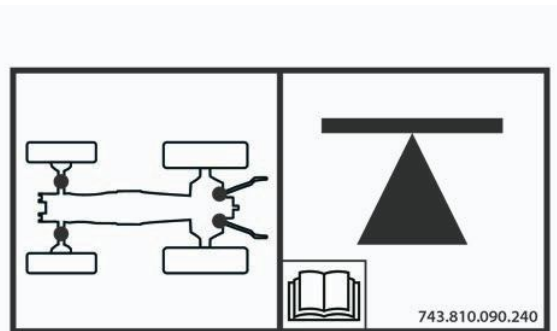

### 1.1.4 Note on hydraulics

If work has been carried out on the hydraulic system on the vehicle, in particular the steering, the hydraulic system must be checked in line with the test report.

## 1.1.5 Assignment table FENDT T types to the EU Type Approval Number

The EU type approval number consists of the lower case letter "e" followed by the code letter or number of the member state granting the EU type approval. The FENDT T type designation classifies the relevant series and forms part of the 17-digit vehicle identification number (VIN).



Fig. 3 Exemplary illustration

Series	FENDT 200 Vario V/F/P	FENDT 200 Vario	FENDT 300 Vario
<b>Type approval number</b>	<b>e1*167/2013*00053</b>		<b>e1*167/2013*00054</b>
<b>Chassis numbers</b>	T232	T300	T347
	T233	T301	T348
	T234	T302	T349
	T235	T303	T350
	T236	T304	
	T239		
	T240		
	T241		
	T242		
	T243		
	T251		
	T252		
	T253		

Series	FENDT 500 Vario	FENDT 700 Vario	FENDT 800 Vario
<b>Type approval number</b>	<b>e1*167/2013*00042</b>	<b>e1*167/2013*00049</b>	<b>e1*167/2013*00047</b>
<b>Chassis numbers</b>	T435	T738	T839
	T436	T739	T840
	T437	T740	T841
	T438	T741	T842
		T742	
		T743	

Series	FENDT 900 Vario	FENDT 1000 Vario
<b>Type approval number</b>	<b>e1*167/2013*00056</b>	<b>e1*167/2013*00055</b>
<b>Chassis numbers</b>	T950	T527

	T951	T528
	T952	T529
	T953	T530
	T954	

### 1.1.6 Change wheels



**DANGER:**  
Secure the tractor to prevent it rolling.



**DANGER:**  
Always use support stands when working on the vehicle



**WARNING:**  
Make sure that the surface on which jack is placed is flat, solid and non-slip. Do not place wooden blocks or similar supports under the jack. Otherwise, the vehicle may fall off the jack and seriously injure you.



**WARNING:**  
Do not start the engine at any time while changing wheels.



**WARNING:**  
The jack is only intended to lift the vehicle for a short period of time while wheels are being changed.



**WARNING:**  
Make sure that the permissible vertical load capacity and lifting height of the jack are not exceeded.



**WARNING:**  
Extra equipment such as wheel weights, twin tires etc. must be removed before changing a wheel.

If you do not position the jack under the jacking point correctly, the vehicle

- may fall off the jack
- and you or other individuals
- may be injured.

Instructions for using wheel nuts

- Replace any wheel nuts that are damaged or showing signs of rust.
- Never oil or grease wheel nuts. Lubricated wheel nuts can come loose from the wheel hub.
- Only use wheel nuts that are intended for use with the wheel and vehicle concerned.
- Do not tighten wheel nuts with the vehicle raised. The vehicle may tip over
- After changing the wheels, retighten wheel nuts after 10 running hours and check that tightening torque is as specified (see technical data).

## Support points for jack and support stands

### Front support points

- (A) Support points for the jack.
- (B) Support points for the support stands

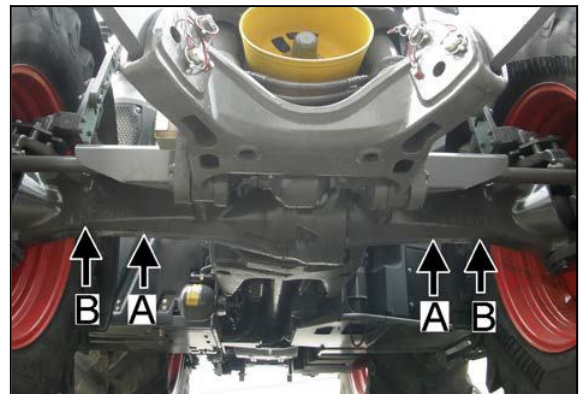

Fig. 4

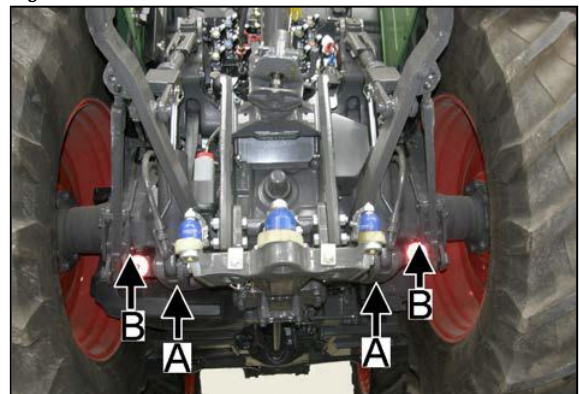

Fig. 5

### Marking on tractor

Some of the suitable support points are marked on the tractor and are also indicated by this decal at the entrance.

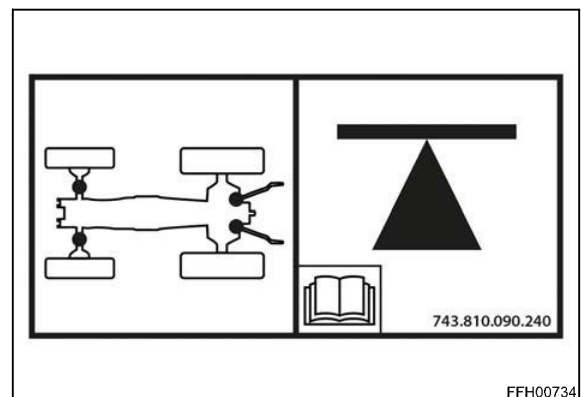

Fig. 6

### 1.1.7 Location of the identification plates

#### Vehicle identification plate



On the right-hand side of the frame

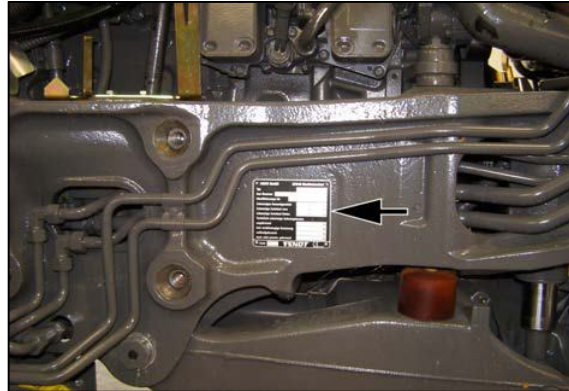

Fig. 7

#### Stamped chassis number



On the right-hand side of the frame, at the front



Fig. 8

#### Front axle identification plate



Right-hand side, on front axle

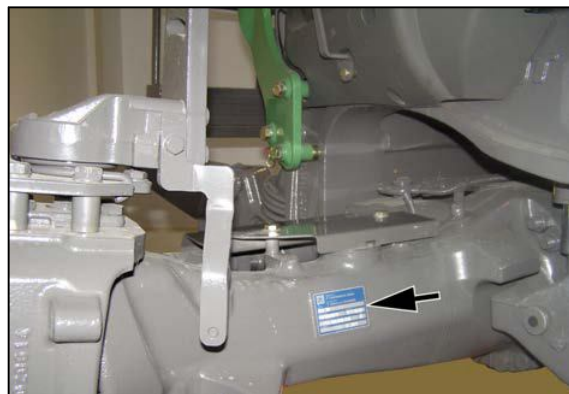

Fig. 9

## engine identification plate



At the top of the valve cover and on the right-hand side of the crankcase



Fig. 10

## Transmission identification plate



On the right-hand side of the transmission housing, behind the heat exchanger

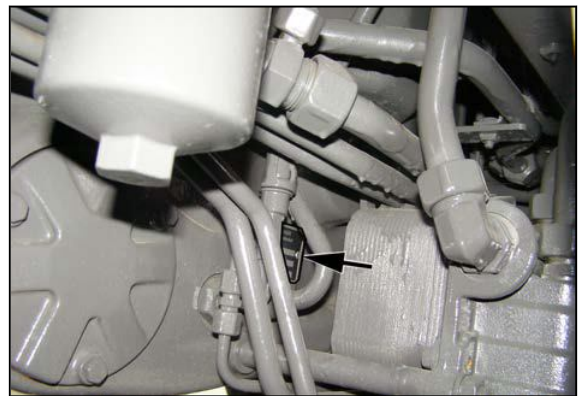

Fig. 11

## Vario transmission insert identification plate



At the top of the Vario transmission insert



Remove cab, remove transmission cover

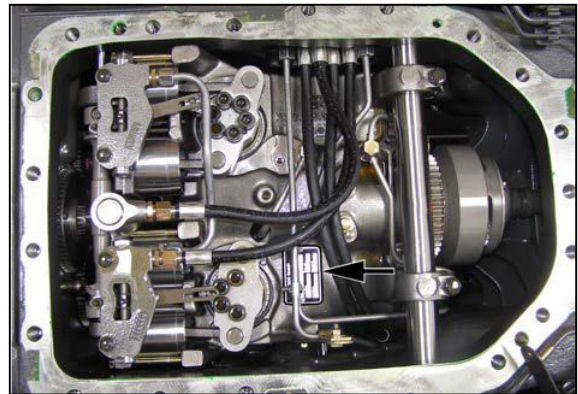

Fig. 12

## Cab identification plate



In the cab, on the left-hand B-pillar between the panel and the side plate



Fig. 13



**Suggest:**

**For more complete manuals. Please go to the home page.**

**<https://www.ebooklibonline.com>**

**If the above button click is invalid. Please download this document first, and then click the above link to download the complete manual.**

**Thank you so much for reading**

### Trailer hitch identification plate

**NOTE:**

See also: *Operating Manual*



On the right-hand side of the trailer hitch frame

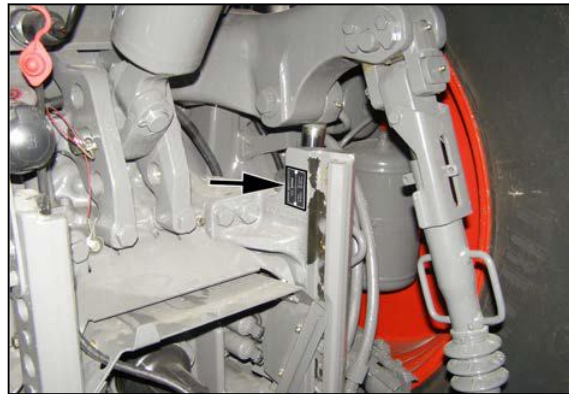

Fig. 14

### Automatic trailer hitch identification plate

**NOTE:**

See also: *Operating Manual*



On the trailer hitch

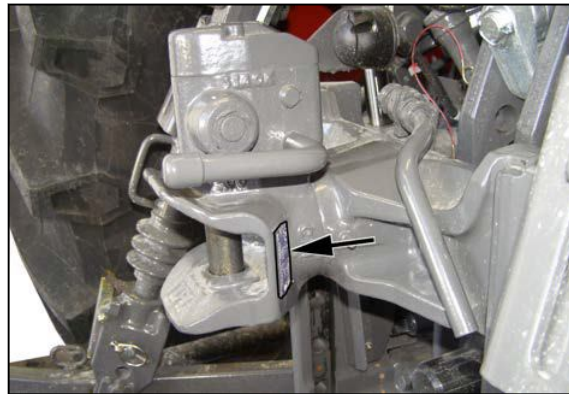

Fig. 15

### Ball coupling (height adjustable) identification plate

**NOTE:**

See also: *Operating Manual*



On the ball-type coupling

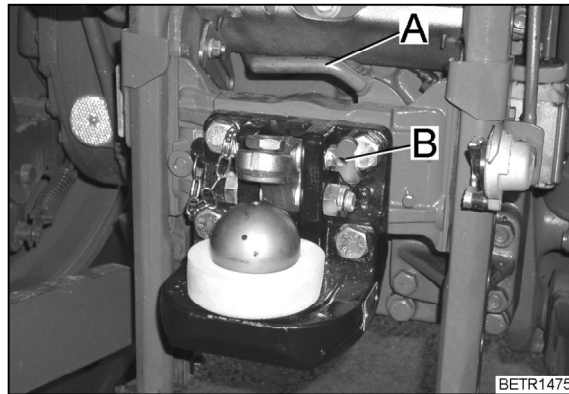

Fig. 16

### Ball coupling identification plate

**NOTE:**

See also: *Operating Manual*



On the ball-type coupling



Fig. 17

## Drawbar identification plate

**NOTE:**

See also: *Operating Manual*



On the draw bar

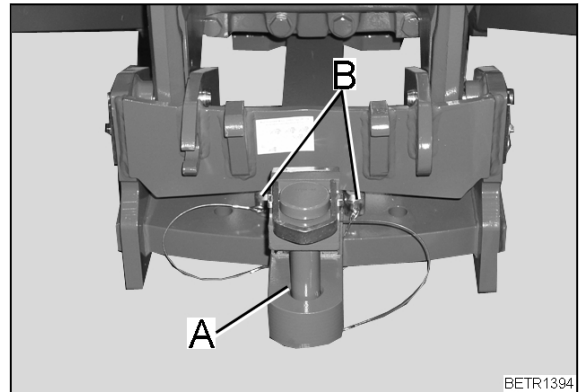

Fig. 18

## Piton-Fix identification plate

**NOTE:**

See also: *Operating Manual*



On Piton-Fix



Fig. 19

## Hydraulic trailer hitch identification plate

**NOTE:**

See also: *Operating Manual*



On the hydraulic trailer hitch

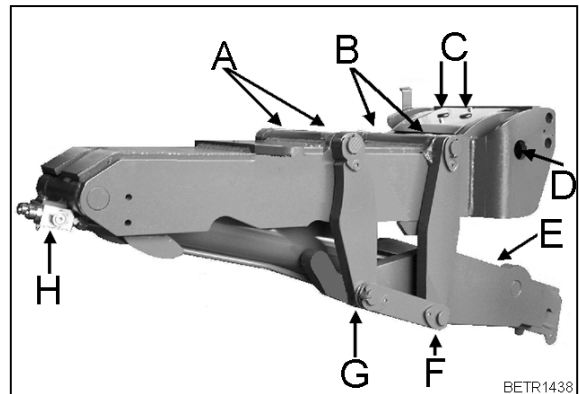

Fig. 20

## 1.1.8 Biodegradable hydraulic oil

### Oil quality

Use rapeseed-oil and synthetic-based HEES biodegradable hydraulic oil with a viscosity in accordance with ISO VG 32-ISO VG 46.

**NOTE:**

*Polyglycol-based synthetic oils cannot be used.*

### Instructions for use

Biodegradable hydraulic oil is suitable for winter temperatures down to approx. -15°C.

Vegetable-based hydraulic oil may thicken in outside temperatures below approx. -15°C or if the tractor is not used for long periods of time. After a cold start, allow a short warm-up time at medium engine speed

**<https://www.ebooklibonline.com>**

Hello dear friend!

Thank you very much for reading.

Enter the link into your browser.

The full manual is available for immediate download.

**<https://www.ebooklibonline.com>**