

KOBELCO

SHOP MANUAL

HYDRAULIC EXCAVATOR

**SK230LC-VI
SK250LC-VI
SK250NLC-VI**

S5LQ0011E-00 NA

Issued 12-1999

SK230LC-VI LQ08-04501~
SK250LC-VI LL08-03001~
SK250NLC-VI LL08-03001~



SK230LC-VI, SK250LC-VI, SK250NLC-VI
HYDRAULIC EXCAVATOR



SHOP MANUAL

APPLICABLE

SK230LC-VI LQ08-04501~
SK250LC-VI LL08-03001~
SK250NLC-VI LL08-03001~

Kobelco Construction Machinery America, LLC reserves the right to make improvements in design or changes in specifications at any time without incurring any obligation to install them on units previously sold.

All data given in this publication is subject to production variations. Dimensions and weights are only approximate. Illustrations do not necessarily show products in standard condition. For exact information about any particular product, please consult your Dealer.

Revision History			
Issue	Issue Date	Applicable Machines	Remarks
First Edition	12-1999	SK230LC-VI, SK250LC-VI, SK250NLC-VI	S5LQ0011E-00 NA

<https://www.ebooklibonline.com>

Hello dear friend!

Thank you very much for reading.

Enter the link into your browser.

The full manual is available for immediate download.

<https://www.ebooklibonline.com>

HYDRAULIC EXCAVATOR

**SHOP
MANUAL**

model

SK230(LC)VI

SK250(LC)VI

SK250NLCVI

INDEX

1	SPECIFICATION SECTION
2	MAINTENANCE SECTION
3	SYSTEM SECTION
4	DISASSEMBLY SECTION
5	TROUBLESHOOTING
6	ENGINE SECTION
7	INSTALLATION PROCEDURES FOR OPTIONAL ATTACHMENT

MAINTENANCE SPECIFICATION

SYSTEM

DISASSEMBLING

TROUBLESHOOTING

E/G

OPT.

KOBELCO

Book code No. S5LQ0011E

NOTES

WARNING

SAFETY

WARNING

The proper and safe lubrication and maintenance for this machine, recommended by KOBELCO are outlined in the OPERATION & MAINTENANCE GUIDE for this machine.

Improper performance of lubrication or maintenance procedures is dangerous and could result in injury or death. Read and understand the OPERATION & MAINTENANCE GUIDE before performing any lubrication or maintenance.

The serviceman or mechanic may be unfamiliar with many of the systems on this machine. This makes it important to use caution when performing service work. A knowledge of the system and or components is important before the removal or disassembly of any component.

Because of the size of some of the machine components, the serviceman or mechanic should check the weights noted in this Manual. Use proper lifting procedures when removing any components.

Following is a list of basic precautions that should always be observed.

1. Read and understand all Warning plates and decals on the machine before operating, lubricating or repairing this product.
2. Always wear protective glasses and protective shoes when working around machines. In particular, wear protective glasses when pounding on any part of the machine or its attachments with a hammer or sledge. Use welders gloves, hood / goggles, apron and other protective clothing appropriate to the welding job being performed. Do not wear loose-fitting or torn clothing. Remove all rings from fingers when working on machinery.
3. Disconnect battery and discharge any capacitors before starting to work on machine. Hang "Do Not Operate" tag in the Operator's Cab.
4. If possible, make all repairs with the machine parked on a level, hard surface. Block machine so it does not roll while working on or under machine.
5. Do not work on any machine that is supported only by lift jacks or a hoist. Always use blocks or jack stands to support the machine before performing any disassembly.

WARNING

Do not operate this machine unless you have read and understand the instructions in the OPERATORS MANUAL. Improper machine operation is dangerous and could result in injury or death.

6. Relieve all pressure in air, oil or water systems before any lines, fittings or related items are disconnected or removed. Always make sure all raised components are blocked correctly and be alert for possible pressure when disconnecting any device from a system that utilizes pressure.
7. Lower the bucket, blade, ripper or other attachment to the ground before performing any work on the machine. If this cannot be done, make sure the bucket, blade, ripper or other attachment is blocked correctly to prevent it from dropping unexpectedly.
8. Use steps and grab handles when mounting or dismounting a machine. Clean any mud or debris from steps, walkways or work platforms before using. Always face machine when using steps, ladders and walkways. When it is not possible to use the designed access system, provide ladders, scaffolds, or work platforms to perform safe repair operations.
9. To avoid back injury, use a hoist when lifting components which weigh 23 kg (50 lbs) or more. Make sure all chains, hooks, slings, etc., are in good condition and are in the correct capacity. Be sure hooks are positioned correctly. Lifting eyes are not to be side loaded during a lifting operation.
10. To avoid burns, be alert for hot parts on machines which have just been stopped and hot fluids in lines, tubes and components.
11. Be careful when removing cover plates. Gradually back off the last two bolts or nuts located at opposite ends of the cover or device and pry cover loose to relieve any spring or other pressure, before removing the last two bolts or nuts completely.
12. Be careful when removing filler caps, breathers and plugs on the machine. Hold a rag over the cap or plug to prevent being sprayed or splashed by liquids under pressure. The danger is even greater if the machine has just been stopped because fluids can be hot.

 **WARNING**

13. Always use tools that are in good condition and be sure you understand how to use them before performing any service work.
 14. Reinstall all fasteners with same part number. Do not use a lesser quality fastener if replacements are necessary.
 15. Repairs, which require welding, should be performed only with the benefit of the appropriate reference information and by personnel adequately trained and knowledgeable in welding procedures. Determine type of metal being welded and select correct welding procedure and electrodes, rods or wire to provide a weld metal strength equivalent at least to that of parent metal. Always disconnect battery during welding operations to protect sensitive electric equipment.
 16. Do not damage wiring during removal operations. Reinstall the wiring so it is not damaged nor will it be damaged in operation by contacting sharp corners, or by rubbing against some object or hot surface. Do not connect wiring to a line containing fluid.
 17. Be sure all protective devices including guards and shields are properly installed and functioning correctly before starting a repair. If a guard or shield must be removed to perform the repair work, use extra caution.
 18. Loose or damaged fuel, lubricant and hydraulic lines, tubes and hoses can cause fires. Do not bend or strike high-pressure lines or install ones, which have been bent or damaged. Inspect lines, tubes and hoses carefully. Do not check for leaks with your hands. Pinhole (very small) leaks can result in a high velocity oil stream that will be invisible close to the hose. This oil can penetrate the skin and cause personal injury. Use cardboard or paper to locate pinhole leaks.
 19. Tighten connections to the correct torque. Make sure that all heat shields, clamps and guards are installed correctly to avoid excessive heat, vibration or rubbing against other parts during operation. Shields that protect against oil spray onto hot exhaust components in event of a line, tube or seal failure must be installed correctly.
 20. Do not operate a machine if any rotating part is damaged or contacts any other part during operation. Any high speed-rotating component that has been damaged or altered should be checked for balance before reusing.
 21. On track-type machines, be careful when servicing or separating tracks. Chips can fly when removing or installing a track pin. Wear safety glasses and long sleeve shirts. Track can unroll very quickly when separated. Keep away from front and rear of machine. The machine can move unexpectedly when both tracks are disengaged from the sprockets. Block the machine to prevent it from moving.
 22. Caution should be used to avoid breathing dust that may be generated when handling components containing asbestos fibers. If this dust is inhaled, it can be hazardous to your health. Components in KOBELCO products that may contain asbestos fibers are brake pads, brake band and lining assemblies, clutch plates and some gaskets. The asbestos used in these components is usually bound in a resin or sealed in some way. Normal handling is not hazardous as long as airborne dust, which contains asbestos, is not generated.
- If dust, which may contain asbestos, is present, there are several common sense guidelines that should be followed.
- a. Never use compressed air for cleaning.
 - b. Avoid brushing or grinding of asbestos containing materials.
 - c. For clean up, use wet methods or a vacuum equipped with a high efficiency particulate air (HEPA) filter.
 - d. Use exhaust ventilation on permanent machining jobs.
 - e. Wear an approved respirator if there is no other way to control the dust.
 - f. Comply with applicable rules and regulations for the work place.
 - g. Follow environmental rules and regulations for disposal of asbestos.
 - h. Avoid areas where asbestos particles may be in the air.

SK230(LC) VI
 SK250(LC) VI
 SK250NLC VI

Index of Shop Manual

Book Code No. Distribution Year—Month			Index No	Title	
S5LQ0111E 1999-12			MAINTENANCE SPECIFICATION	OUTLINE	LQ01
S5LQ0211E 2000-02				SPECIFICATION	LQ02
S5LQ0311E 1999-12				ATTACHMENT DIMENSION	LQ03
S5LQ1111E 1999-12			MAINTENANCE	TOOLS	LQ11
S5LQ1211E 2000-02				STANDARD MAINTENANCE TIME SCHEDULE	LQ12
S5LQ1311E 1999-12				MAINTENANCE STANDARD AND TEST PROCEDURE	LQ13
S5LQ2111E 1999-12				MECHATRO CONTROL SYSTEM	LQ21
S5LQ2211E 2000-02				HYDRAULIC SYSTEM	LQ22
S5LQ2311E 2000-02			SYSTEM	ELECTRICAL SYSTEM	LQ23
S5LQ2411E 2000-02				COMPONENTS SYSTEM	LQ24
S5LQ2511E 1999-12				AIR-CONDITIONER SYSTEM	LQ25
—				—	
S5LQ3111E 2000-02				DISASSEMBLING	DISASSEMBLING AND ASSEMBLING
S5LQ3211E 2000-02			ATTACHMENT		LQ32
S5LQ3311E 2000-02			UPPER STRUCTURE		LQ33
S5LQ3411E 2000-02			TRAVEL SYSTEM		LQ34
S5LQ4111E 2000-02			TROUBLESHOOTING	MECHATRO CONTROL	LQ41
S5LQ4211E 2000-02				HYDRAULIC	LQ42
S5LQ4311E 2000-02				ELECTRICAL	LQ43
S5LQ4411E 2000-02				ENGINE	LQ44
S5LQ5111E 2000-02			E/G	ENGINE	LQ51
			OPT.	MOUNTING THE BREAKER AND NIBBLER & BREAKER	LQ63
LQ08-04501~ LL08-03001~				APPLICABLE MACHINES	

NOTES

KOBELCO

Book code No.

S5LQ01 11E

SHOP MANUAL

SK230(LC)VI

SK250(LC)VI **LQ01**

SK250NLCVI

OUTLINE

TABLE OF CONTENTS

1. GENERAL PRECAUTIONS FOR MAKING REPAIRS 1
2. ESCAPING PROCEDURE IN CASE OF EMERGENCY 4
3. INTERNATIONAL UNIT CONVERSION SYSTEM 5

KOBELCO CONSTRUCTION MACHINERY CO., LTD.

Applicable Machines
LQ08-04501 ~
LL08-03001 ~

Revision	Date of Issue	Remarks
First edition	December, 1999	S5LQ0111E K

1. GENERAL PRECAUTIONS FOR MAKING REPAIRS



1.1 PREPARATION BEFORE DISASSEMBLING

- (1) Knowledge of operating procedure
Read Operator's Manual carefully to understand the operating procedure.
- (2) Cleaning machines
Clean machines of soil, mud, and dust before carrying into the service shop.
Carrying a soiled machine into the service shop, causes making less efficient work and damage of parts, and interferes with rust prevention and dust protection while reassembling.
- (3) Inspecting machines
Confirm the disassembling section before starting work, determine the disassembly procedure taking the conditions in work shop into account, and request to procure necessary parts in advance.
- (4) Recording
Record the following items to keep contact and prevent malfunction from recurring.
 - 1) Inspecting date, place
 - 2) Model name, Applicable machine No., Records on hour meter
 - 3) Trouble condition, place, cause
 - 4) Visible oil leakage, water leakage and damage
 - 5) Clogging of filters, etc., oil level, oil quality, oil contamination and looseness which can be inspected.
- (5) Examine the problems on the basis of operation rate with the last inspection date and records on hour meter.
- (6) Arrangement and cleaning in service shop
 - 1) Tools required for repair work.
 - 2) Specify places to put the disassembled parts on in advance.
 - 3) Prepare oil pans for leaking oil, etc.



1.2 SAFETY WHEN DISASSEMBLING AND ASSEMBLING

- (1) Safety
 - 1) Wear appropriate clothing, safety shoes, safety helmet, goggles, and clothes with long sleeves.
 - 2) Suspend warning tag "Don't operate" from lever, and begin preliminaries before getting down to work.
 - 3) Before starting inspection and maintenance which contain the danger of being caught in machine, stop the engine.

- 4) Confirm the position of first-aid kit and fire extinguisher, and also where to make contact for emergency measure and ambulance to prepare for accidents and fire.
- 5) Choose a hard, flat and safe place, and put attachment on the ground without fail.
- 6) Use crane, etc. to remove parts of heavy weight (20kg [44 lbs] or more).
- 7) Use proper tools, and change or repair defective tools.
- 8) Machine and attachment required to work in the lifting condition should be supported with supports or blocks securely.

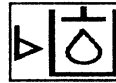

1.3 DISASSEMBLING AND ASSEMBLING HYDRAULIC EQUIPMENT

- (1) Removing hydraulic equipment assy
 - 1) Before removing pipes, release the pressure of hydraulic oil tank, or open the cover on the return side to tank, and take out the filter.
 - 2) Put the oil in the removed pipes in reservoir taking care it is not spilled on the ground.
 - 3) Pipes with plugs or caps to prevent oil leaking, entry of dust, etc.
 - 4) Clean the outside surface of equipment, etc. before disassembling, and drain hydraulic oil and gear oil before putting them on working bench.
- (2) Disassembling hydraulic equipment
 - 1) Since performance and function of hydraulic equipment after disassembly and assembly results in immunity from responsibility on the manufacture's side, disassembly, assembly and conversion without permission are strictly prohibited.
 - 2) If it is unavoidably necessary to disassemble and convert, it should be carried out by experts or personnel authorized through service training.
 - 3) Make match mark on parts for reassembling.
 - 4) Before disassembling, read Disassembling Instruction in advance, and determine if the disassembly and assembly are permitted or not.
 - 5) For parts which are required to use jig and tools, don't fail to use the specified jig and tools.
 - 6) For parts which can not be removed in the specified procedure, never force removal. First check for the cause.

- 7) The removed parts should be put in order and tagged so as to install on proper places without confusion.
 - 8) For common parts, pay attention to the quantity and places.
- (3) Inspecting parts
- 1) Check that the disassembled parts are free from adherence, interference and non-uniform working face.
 - 2) Measure the wear of parts and clearance, and record the measured values.
 - 3) If an abnormality is detected, repair or replace the parts.
- (4) Reassembling hydraulic equipment
- 1) Before cleaning, turn the fan on or open doors to ventilate air.
 - 2) Before assembly, clean parts roughly first, and then completely.
 - 3) Remove with oil by compressed air, and apply hydraulic oil or gear oil, and then assemble them.
 - 4) Replace the removed O ring, back-up rings and oil seal with new ones, and apply grease oil on them before assembling.
 - 5) Removes stain and water on the surface on which liquid sealant are applied, decrease them, and apply liquid sealant on them.
 - 6) Before assembling, remove rust preventives on new parts.
 - 7) Use special tools to fit bearings, bushing and oil seal.
 - 8) Assemble parts matching to the marks.
 - 9) After completion, check that there is no omission of parts.

- (5) Installing hydraulic equipment
- 1) Confirm hydraulic oil and lubrication oil.
 - 2) Air release is required in the following cases ;
 - a. Change of hydraulic oil
 - b. Replacement of parts on suction pipe side
 - c. Removing and attaching hydraulic pump
 - d. Removing and attaching swing motor
 - e. Removing and attaching travel motor
 - f. Removing and attaching hydraulic cylinder

⚠ If hydraulic oil and lubricating oil are not filled and also air bleed is not performed, the hydraulic equipment may be damaged.

- 3) For air bleed of hydraulic pump and swing motor, loosen drain plug on the upper part, start engine, and run in low idling, then bleed air until hydraulic oil is oozed out. After completion of air bleed, tighten plug securely.
- 4) For air bleed of travel motor and hydraulic cylinder, starts engine and operate it for 10 minutes or more at no-load and low speed.

⚠ For cylinder, don't move it to the stroke end at beginning.

- 5) Air in pilot circuit can be bled out by only operating digging, swing and traveling motions thoroughly.
- 6) Check hydraulic oil level.
Move attachments to hydraulic oil check position, and check hydraulic oil level of tank. Refill oil if the oil level is lower than the minimum level.

How to check oil level of hydraulic oil tank

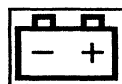
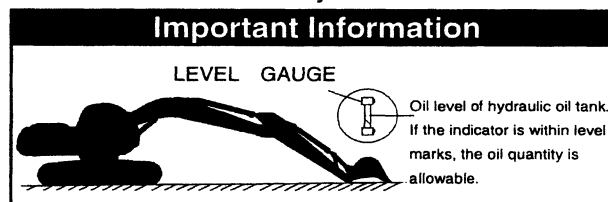

1.4 ELECTRICAL EQUIPMENT

- (1) The disassembly of electrical equipment is not allowed.
- (2) Handle equipment with care so as not to drop it or bump it.
- (3) Connector should be removed by unlocking while holding the connector. Never stress in tension to the caulked section by pulling wire.
- (4) Check that connector is connected and locked completely.
- (5) Starter key off before removing and connecting connector
- (6) Starter key off before touching terminals of starter and alternator.
- (7) Remove battery grounding terminal before beginning work close to battery and battery relay with tools.
- (8) Wash machine with care so as not to splash water on electrical equipment and connector.

- (9) When water has entered in the waterproofed connector, the removing of water is not easy. So check the removed waterproofed connector with care to protect it from entry of water. If moisture adheres on it, dry it completely before connecting.



Battery electrolyte is dangerous.

The battery electrolyte is dilute sulfuric acid, and causes scald and loss of eyesight by adhering on eyes, skin and clothes. When the electrolyte has adhered on them, take an emergency measure immediately and see a doctor for medical advice.

- When it has adhered on skin ;
Wash with soap and water.
- When it has got in eyes ;
Wash in water for 10 minutes or more immediately.
- When it has spilled out in large quantity ;
Use sodium bicarbonate to neutralize, or wash away with water.
- When it was swallowed ;
Drink milk or water.
- When it has adhered on clothes ;
Wash it immediately.

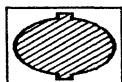

1.5 HYDRAULIC PARTS

- 1) O ring
 - Check that O ring is free from flaw and has elasticity before fitting.
 - Even if the size of O ring is equal, the usage differs, for example in dynamic and static sections, the rubber hardness also differs according to the pressure force, and also the quality differs depending on the materials to be seated. So, choose proper O ring.
 - Fit O ring so as to be free from distortion and bend.
 - Floating seal should be put in pairs.
- 2) Flexible hose (F hose)
 - Even if the connector and length of hose are the same, the parts differ according to the withstanding pressure. Use proper parts.

- Tighten it to the specified torque, and check that it is free from distortion, over tension, interference, and oil leakage.

1.6 WELD REPAIR

- (1) The weld repair should be carried out by authorized personnel in the specified procedure after disconnecting the grounding cable of battery. If the grounding cable is not disconnected, the electrical equipment may be damaged.
- (2) Remove parts which may cause flame due to the entry of spark beforehand.
- (3) Repair attachments which are damaged, giving particular attention to the plated section of piston rod to protect it from sparks, and don't fail to cover the section with fire clothes.

1.7 ENVIRONMENTAL ISSUES

- (1) Engine should be started and operated in the place where air can be sufficiently ventilated.
- (2) Industrial waste disposal
The following parts follows the regulation.
Waste oil, waste container
Battery
- (3) Asbestos parts
Breathing dust that may be generated when handling components containing asbestos fibers raises danger of getting lung cancer. Don't raise dust by compressed air and breath it.
Parts to be handled with care :
Brake parts, gasket, etc.
- (4) Precautions for handling hydraulic oil
Hydraulic oil may cause inflammation of eyes. Wear goggles to protect eyes on handling it.
 - When it has got in eyes ;
Wash eyes with water until the stimulus is gone.
 - When it was swallowed ;
Don't force him to vomit it, but immediately receive medical treatment.
 - When it has adhered on skin ;
Wash with soap and water.
- (5) Others
For spare parts, grease and oil, use KOBELCO genuine ones.



Suggest:

For more complete manuals. Please go to the home page.

<https://www.ebooklibonline.com>

If the above button click is invalid. Please download this document first, and then click the above link to download the complete manual.

Thank you so much for reading

2. ESCAPING PROCEDURE IN CASE OF EMERGENCY

2.1 WHEN CAB DOOR DOES NOT OPEN ;

- (1) Escape from the front window.
- (2) Escape from skylight.
- (3) When front window and skylight do not open ;
A life hammer is provided on the right-hand side of the cab at all times. Escape by breaking the glass at the escape label (seal mark) at the back of the cab.

⚠ Break the window glass with care to protect eyes, and don't fail to break the window on which label "Emergency exit" is stuck.

2.2 WHEN IT IS IMPOSSIBLE TO GO OUT FROM THE SOFT GROUND BY ITSELF ;

- (1) Towing by other machine
There are holes to pass through shackle on the front and rear sides of track frame as in the right figure. Tow it with shackle and wire rope passing through those holes.

Wire dia ; $\text{Ø}26(1.024'') \times 4\text{m}(13'1'')$ or more

⚠ Before starting towing, keep away from the wire rope between two machines, and move it slowly at low speed.

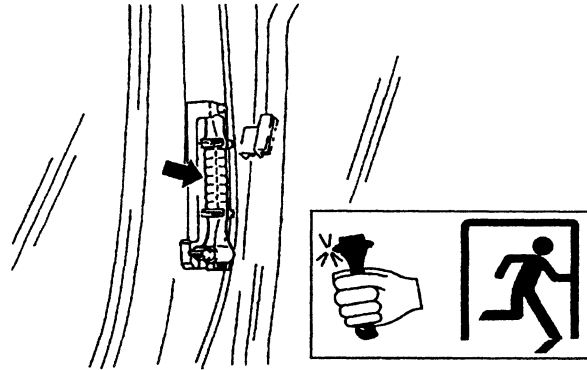

Fig. 2-1 Life hammer and "Emergency Exit" seal

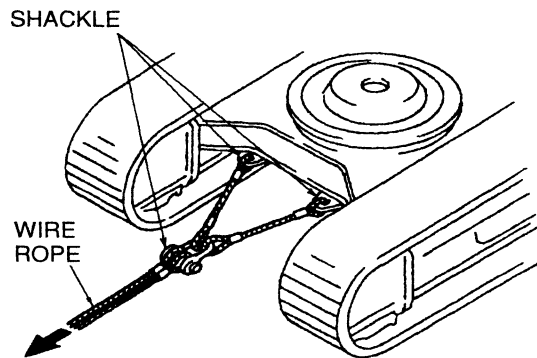

Fig. 2-2 Towing by track frame

3. INTERNATIONAL UNIT CONVERSION SYSTEM

Introduction

Although this manual uses the JIS unit system. If you need SI unit, refer to following international system of units.

Given hereinunder are an excerpt of the units that are related to this manual :

1. Etymology of SI Units

French : Le Système International d' Unitès

English: International System of Units

2. Construction of SI Unit System

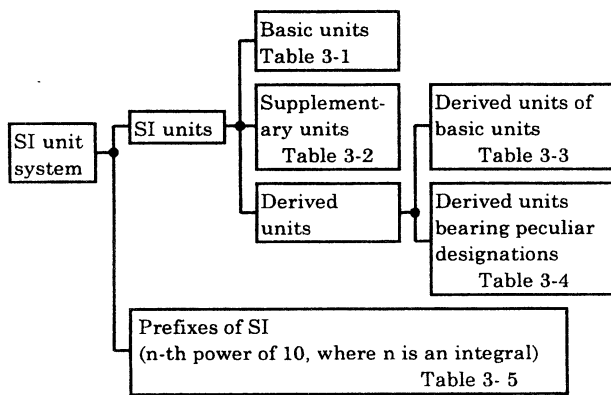

(1) Basic Units

Table 3-1

QUANTITIES	DESIGNATION	SIGN
Length	Meter	m
Mass	Kilogram	kg
Time	Second	s
Current	Ampere	A
Thermodynamic temperature	Kelvin	K
Gram molecule	Mol	mol
Luminous intensity	Candela	cd

(2) Supplementary Units

Table 3-2

QUANTITIES	DESIGNATION	SIGN
Plane angle	Radian	rad
Solid angle	Steradian	sr

(3) Derived Units of Basic Units

Table 3-3

QUANTITIES	DESIGNATION	SIGN
Area	Square meter	m ²
Volume	Cubic meter	m ³
Velocity	Meter per second	m/s
Acceleration	Meter per second / second	m/s ²
Density	Kilogram per cubic meter	kg/m ³

(4) Derived Units bearing Peculiar Designations

Table 3-4

QUANTITIES	DESIGNATION	SIGN	DERIVED UNIT
Frequency	Hertz	Hz	1Hz=1s ⁻¹
Force	Newton	N	1N=1kgf·m/s ²
Pressure, Stress	Pascal	Pa	1Pa=1N/m ²
Energy, Work, Quantity of heat	Joule	J	1J=1N·m
Power, Motive power, Electric power	Watt	W	1W=1J/s
Charge, Quantity of electricity	Coulomb	C	1C=1A·s
Potential, Voltage, Electromotive force	Volt	V	1V=1J/C (1W/A)
Quantity of static electricity, Capacitance	Farad	F	1F=1C/V
Electric resistance	Ohm	Ω	1Ω=1V/A
Celcius temperature	Celcius degree or degree	°C	t°C=(t+273.15)K
Illuminance	lux	lx	1lx=1lm/m ²

(5) Prefixes of SI

Table 3-5

PREFIX		POWER
DESIGNATION	SIGN	
Giga-	G	10 ⁹
Mega-	M	10 ⁶
Kilo-	k	10 ³
Hecto-	h	10 ²
Deca-	da	10
Deci-	d	10 ⁻¹
Centi-	c	10 ⁻²
Milli-	m	10 ⁻³
Micro-	μ	10 ⁻⁶
Nano-	n	10 ⁻⁹
Pico-	p	10 ⁻¹²

(6) Unit Conversion Table

Table 3-6

QUANTITIES	JIS	SI	REMARKS
Mass	kg	kg	
Force	kgf	N	1kgf=9.807N
Torque	kgf·m	N·m	1kgf·m=9.807N·m
Pressure	kgf/cm ²	MPa	1kgf/cm ² =0.098MPa
Motive power	PS	kW	1PS=0.7355kW
Revolution	rpm	min ⁻¹	r/min ※1

※1 Units that are allowed to use

<https://www.ebooklibonline.com>

Hello dear friend!

Thank you very much for reading.

Enter the link into your browser.

The full manual is available for immediate download.

<https://www.ebooklibonline.com>