

***Dynamic
Acera*** (Minor Change)

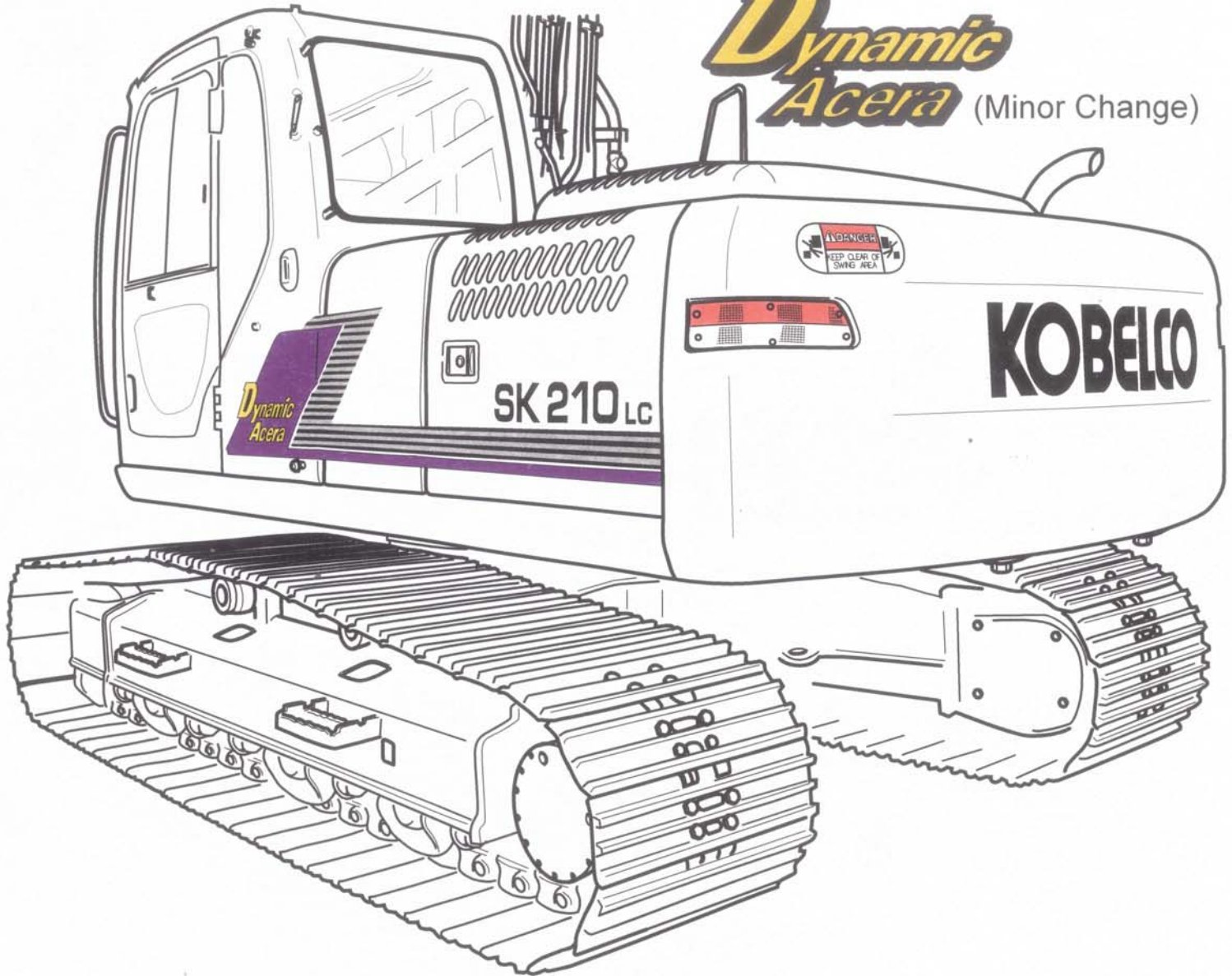

TRAINING MATERIAL



SK160LC...6E	YM03U0522 ~
ED190 ...6E	YL03U0136 ~
SK210LC...6E	YQ08U0969 ~
SK250LC...6E	LL09U0575 ~
SK290LC...6E	LB04U0298 ~
SK330LC...6E	YC07U0623 ~

TABLE OF CONTENTS

Safety Precautions	1
Machine Familiarization	2
Mechatronics	3
Maintenance	4
Cycle Times	5
Hydraulic Motors	6
Pressure Adjustment	7
Schematics	8
Transportation	9
General Specifications	10
Optional Equipment	11
Special Procedures	12

Table of Contents

1.1 GENERAL SAFETY INFORMATION 1-2
1.2 SAFETY PRECAUTIONS 1-2
1.3 PRE-START SAFETY 1-5
1.4 SAFETY DURING OPERATION 1-8
1.5 INSPECTION & MAINTENANCE SAFETY 1-11
1.6 BATTERY SAFETY 1-14
1.7 WARNING LABELS & DECALS 1-15
1.8 PROHIBITED MACHINE OPERATION 1-22
1.9 END OF WORK SHIFT SAFETY 1-24
1.10 PRECAUTIONS FOR TRANSPORTATION 1-25
1.11 PRECAUTIONS FOR TOWING THE MACHINE 1-26

	WARNING	
<p>READ, UNDERSTAND AND FOLLOW ALL SAFETY PRECAUTIONS AND PROCEDURES FOUND IN THIS MANUAL BEFORE ATTEMPTING ANY OPERATION, INSPECTION OR MAINTENANCE OF THIS MACHINE, ATTACHMENT OR SYSTEMS OPERATION. KOBELCO CANNOT ANTICIPATE EVERY POSSIBLE CIRCUMSTANCE THAT MIGHT INVOLVE A POTENTIAL HAZARD. THE WARNINGS IN THIS PUBLICATION AND ON THE PRODUCT ARE THEREFORE NOT ALL INCLUSIVE. IF A TOOL, PROCEDURE, WORK METHOD OR OPERATING TECHNIQUE NOT SPECIFICALLY RECOMMENDED BY KOBELCO IS USED, YOU MUST SATISFY YOURSELF THAT IT IS SAFE FOR YOU AND OTHERS. YOU SHOULD ALSO ENSURE THAT THE PRODUCT WILL NOT BE DAMAGED OR MADE UNSAFE BY THE OPERATION, LUBRICATION, MAINTENANCE AND/OR REPAIR PROCEDURES YOU CHOOSE.</p>		

<https://www.ebooklibonline.com>

Hello dear friend!

Thank you very much for reading.

Enter the link into your browser.



The full manual is available for immediate download.

<https://www.ebooklibonline.com>

SAFETY PRECAUTIONS

1.1 GENERAL SAFETY INFORMATION

1

 **WARNING** 

Do Not operate or perform any maintenance on this machine until all instructions found in this manual have been thoroughly read and understood. Improper operation or maintenance of this machine may cause accidents and could result in serious injury or death.

Always keep this manual in the operators seat pocket.



If it is missing or damaged, place an order with an authorized KOBELCO distributor for a replacement.

If you have any questions, please consult an authorized KOBELCO distributor.

1. Most accidents, which occur during operation, are due to neglect of precautionary measures and safety rules. Sufficient care should be taken to avoid these accidents. Erroneous operation, lubrication or maintenance services are very dangerous and may cause injury or death of personnel. Therefore all precautionary measures, NOTES, DANGERS, WARNINGS and CAUTIONS contained in this manual and on the machine should be read and understood by all personnel before starting any work with or on the machine.
2. Operation, inspection, and maintenance should be carefully carried out, and safety must be given the first priority. Messages of safety are indicated with marks. The safety information contained in this manual is intended only to supplement safety codes, insurance requirements, local laws, rules and regulations.
3. Messages of safety appear in this manual and on the machine. All messages of safety are identified by the words "DANGER", "WARNING" and "CAUTION".
 - a. **DANGER** – Indicates an imminently hazardous situation which, if not avoided, will result in death or serious injury and is represented as follows:

 **DANGER** 

- b. **WARNING** – Indicates a potentially hazardous situation which, if not avoided, could result in death or serious injury and is represented as follows:

 **WARNING** 

- c. **CAUTION** – Indicates a potentially hazardous situation which, if not avoided, may result in minor or moderate injury. It may also be used to alert against possible damage to the machine and its components and is represented as follows:



 **CAUTION** 

NOTE

In this book the symbol () will be omitted in cases where only damage to the machine may occur; however, this symbol will be placed when ever personal injury may occur.

4. It is very difficult to forecast every danger that may occur during operation. However, safety can be ensured by fully understanding proper operating procedures for this machine according to methods recommended by KOBELCO.
5. While operating the machine, be sure to perform work with great care, so as not to damage the machine, or allow accidents to occur.
6. Continue studying this manual until all Safety, Operation and Maintenance procedures are completely understood by all persons working with the machine.

1.2 SAFETY PRECAUTIONS

 **WARNING** 

The proper and safe lubrication and maintenance for this machine, recommended by KOBELCO, is outlined in the OPERATORS MANUAL for this machine.

Improper performance of lubrication or maintenance procedures are dangerous and could result in injury or death. Read and understand the OPERATORS MANUAL before performing any lubrication or maintenance.

The serviceman or mechanic may be unfamiliar with many of the systems on this machine. This makes it important to use caution when performing service work. A knowledge of the system and or components is important before the removal or disassembly of any component.

Because of the size of some of the machine components, the serviceman or mechanic should check the weights noted in this manual. Use proper lifting procedures when removing any components. Weight of components table for this machine are shown in this manual in Section VI - SPECIFICATIONS.

SAFETY PRECAUTIONS

The following is a list of basic precautions that must always be observed.

1. Read and understand all Warning plates and decals on the machine before Operating, Maintaining or Repairing this machine.
2. Always wear protective glasses and protective shoes when working around machines. In particular, wear protective glasses when using hammers, punches or drifts on any part of the machine or attachments. Use welders gloves, hood/goggles, apron and the protective clothing appropriate to the welding job being performed. Do not wear loose fitting or torn clothing. Remove all rings from fingers, loose jewelry, confine long hair and loose clothing before working on this machinery.
3. Avoid lubrication or mechanical adjustments with the machine in motion or the engine running.
4. Disconnect the battery and hang a "Do Not Operate" tag in the Operators Compartment. Remove ignition keys.
5. If possible, make all repairs with the machine parked on a level, hard surface. Block the machine so it does not roll while working on or under the machine. Hang a "Do Not Operate" tag in the Operators Compartment.
6. Do not work on any machine that is supported only by lift, jacks or a hoist. Always use blocks or jack stands, capable of supporting the machine, before performing any disassembly.

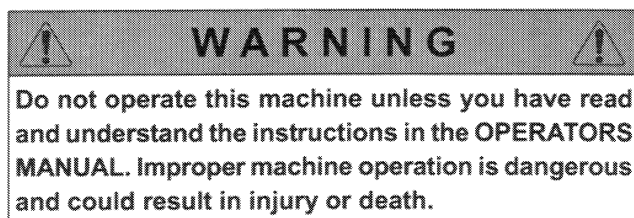

7. Relieve all pressure in air, oil or water systems before any lines, fittings or related items are disconnected or removed. Always make sure all raised components are blocked correctly and be alert for possible pressure when disconnecting any device from a system that utilizes pressure.
8. Lower the bucket, blade, or other attachments to the ground before performing any work on the machine. If this cannot be done, make sure the bucket, blade, rip-

per or other attachment is blocked correctly to prevent it from dropping unexpectedly.

9. Use steps and grab handles when mounting or dismounting a machine. Clean any mud, grease, oil, or debris from steps, walkways or work platforms before using. Always face the machine when using steps, ladders and walkways. When it is not possible to use the designed access system, provide ladders, scaffolds, or work platforms to perform safe repair operations. Refer to item N on page 1-7.
10. To avoid back injury, use a hoist when lifting components which weigh 23 kg (50 lbs) or more. Make sure all chains, hooks, slings, etc., are in good condition and are the correct capacity. Be sure hooks are positioned correctly. Lifting eyes are not to be side loaded during a lifting operation.
11. To avoid burns, be alert for hot parts on machines which have just been stopped and hot fluids in lines, tubes and compartments.
12. Be careful when removing cover plates. Gradually back off the last two bolts or nuts located at opposite ends of the cover or device and carefully pry cover loose to relieve any spring or other pressure, before removing the last two bolts or nuts completely.
13. Be careful when removing filler caps, breathers and plugs on the machine. Hold a rag over the cap or plug to prevent being sprayed or splashed by liquids under pressure. The danger is even greater if the machine has just been stopped because fluids can be hot.
14. Always use the proper tools that are in good condition and that are suited for the job at hand. Be sure you understand how to use them before performing any service work.
15. Reinstall all fasteners with the same part number. Do not use a lesser quality fastener if replacements are necessary.
16. Repairs which require welding should be performed only with the benefit of the appropriate reference information and by personnel adequately trained and knowledgeable in welding procedures. Determine type of metal being welded and select correct welding procedure and electrodes, rods or wire to provide a weld metal strength equivalent at least to that of the parent metal. Make sure to disconnect battery before any welding procedures are attempted.

SAFETY PRECAUTIONS

1

17. Make sure to keep the rearview mirrors, on both sides of the machine, in place, adjusted, and in good condition. Replace any damaged or broken rearview mirrors.
18. Always inspect the operator's seat belt condition, before operation. Check and make sure its support mount is properly tighten. Replace the seat belt every three years regardless of appearance, and tag date of replacement on its support mount for reference.
19. Do not damage wiring during removal operations. Reinstall the wiring so it is not damaged nor will be damaged in operation of the machine by contacting sharp corners, or by rubbing against some object or hot surface. Do not connect wiring to a line containing fluid.
20. Be sure all protective devices including guards and shields are properly installed and functioning correctly before starting a repair. If a guard or shield must be removed to perform the repair work, use extra caution and replace the guard or shield after repair is complete.
21. The maintenance and repair work while holding the bucket raised is dangerous due to the possibility of a falling attachment. Don't fail to lower the attachment and place the bucket to the ground before starting the work.
22. Loose or damaged fuel, lubricant and hydraulic lines, tubes and hoses can cause fires and accidents due to unexpected leaks. Do not bend or strike high pressure lines or install ones which have been bent or damaged. Inspect lines, tubes and hoses carefully. Do not check for leaks with your hands. Very small (pinhole) leaks can result in a high velocity oil stream that will be invisible close to the hose. This oil can penetrate the skin and cause personal injury. Use cardboard or paper to locate pin hole leaks.
23. Tighten connections to the correct torque. Make sure that all heat shields, clamps and guards are installed correctly to avoid excessive heat, vibration or rubbing against other parts during operation. Shields that protect against oil spray onto hot exhaust components in event of a line, tube or seal failure must be installed correctly.
24. Do not operate a machine if any rotating part is damaged or contacts any other part during operation. Any high speed rotating component that has been damaged or altered should be checked for balance before reusing.
25. Be careful when servicing or separating the tracks. Chips can fly when removing or installing a track pin. Wear safety glasses and long sleeve protective clothing. Tracks can unroll very quickly when separated. Keep away from front and rear of machine. The machine can move unexpectedly when both tracks are disengaged from the sprockets. Block the machine to prevent it from moving.
26. Caution should be used to avoid breathing dust that may be generated when handling components containing asbestos fibers. If this dust is inhaled, it can be hazardous to your health. Components in KOBELCO products that may contain asbestos fibers are brake pads, brake band and lining assemblies, clutch plates and some gaskets. The asbestos used in these components is usually bound in a resin or sealed in some way. Normal handling is not hazardous as long as airborne dust which contains asbestos is not generated.

If dust which may contain asbestos is present, there are several common sense guidelines that should be followed.

- a. Never use compressed air for cleaning.
- b. Avoid brushing or grinding of asbestos containing materials.
- c. For clean up, use wet methods or a vacuum equipped with a high efficiency particulate air (HEPA) filter.
- d. Use exhaust ventilation on permanent machining jobs.
- e. Wear an approved respirator if there is no other way to control the dust.
- f. Comply with applicable rules and regulations for the work place.
- g. Follow environmental rules and regulations for disposal of asbestos.
- h. Avoid areas where asbestos particles may be in the air.

SAFETY PRECAUTIONS

1

1.3 PRE-START SAFETY

Many failures that occur during machine operation or servicing result from neglecting fundamental safety precautions. The following safety precautions are given to prevent such failures, but they are only a part of what you must follow. Read, understand and follow all safety precautions found in this manual and on the machine thoroughly before operating the machine. Make sure to understand the machine limits and keep the machine under control at all times.

A. OBSERVE SAFETY PRECAUTIONS

Follow all safety rules, precautions, and operating procedures. If there are other personnel and flagmen working in the area, have them observe the specified signs.

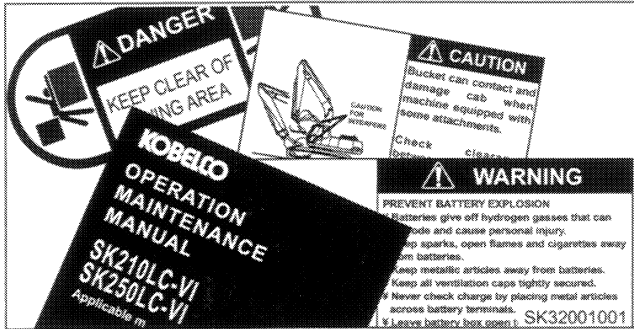

B. WEAR PROTECTIVE CLOTHING

Wear well fitting safety shoes, hard hat, and working clothes, and put on protective glasses, face shield, ear protection and gloves. When necessary, wear reflective vest.

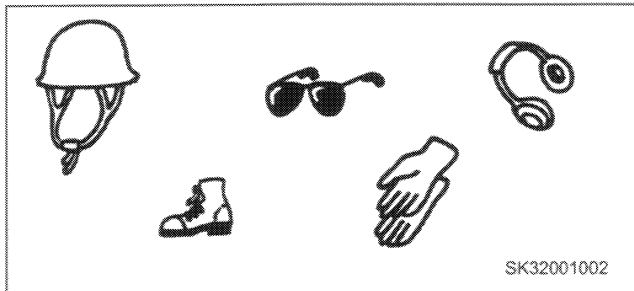

C. READ and UNDERSTAND THE OPERATORS MANUAL

Before operating the machine, read and understand this operators manual thoroughly in order to use the machine effectively and safely.

D. KEEP OPERATORS MANUAL IN MACHINE CAB

Keep this manual in the specified storage area located behind the operators seat for quick reference. Should the operators manual become lost or damaged, contact an authorized KOBELCO distributor to order the operators Manual.

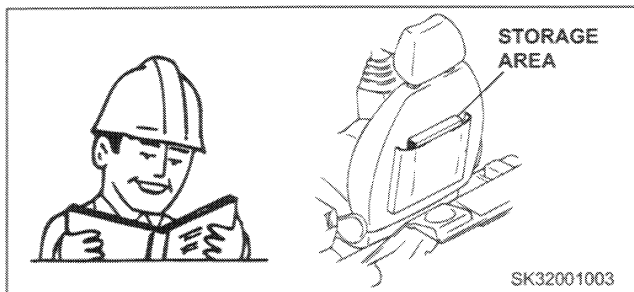

E. HOW TO HANDLE LIFE HAMMER

A life hammer is provided on the right side of cab. In case of emergency, take the life hammer, break the cab glass, and escape from the cab. In addition, the life hammer is equipped with a cutter on the lever side to cut the seat belt, etc.

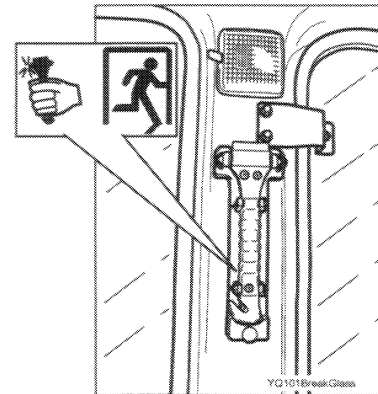

F. PREPARE FOR EMERGENCIES

Have a fire extinguisher and first aid kit ready for emergencies. Know how to operate the fire extinguisher and know where the First Aid Kit is located for easy access in case of emergency.

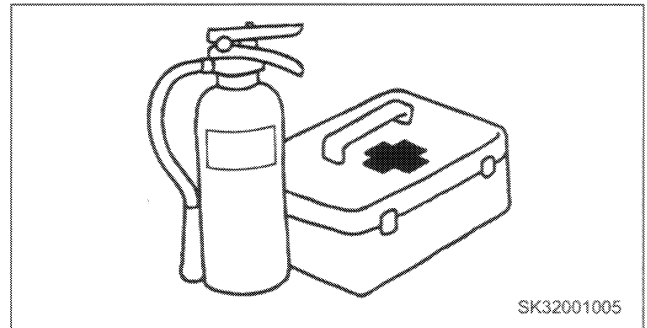

G. DO NOT OPERATE MACHINE WHEN EXCESSIVELY TIRED OR UNDER THE INFLUENCE OF ANY DRUG

Your poor physical condition causes improper reactions. Voluntarily refrain from operating the machine when feeling excessively tired, and never operate the machine under the influence of any drugs.



SAFETY PRECAUTIONS

H. ENSURE SAFETY AT THE WORK SITE

Know the work area! Before operating the machine, carefully survey and record the land and worksite features to prevent the machine from falling or the soil from caving in.

I. PERFORM PRE-START INSPECTION

Before starting the machine, perform a PRESTART inspection of the machine. If any problems are found, repair or replace defective components immediately. **DO NOT OPERATE THE MACHINE** until all problem areas are properly repaired. Always keep the windshield, working lamps, and mirrors clean for good visibility. Also keep clean cab floor and operator's seat at all times. Debris could obstruct and/or cause erratic machine operation. Make sure to maintain operator's controls clean at all times.

J. ENGAGE SAFETY LOCK LEVER BEFORE LEAVING MACHINE

Before leaving the operator's seat, move the safety lock lever to the "LOCKED" (Up) position. This will not allow operation of any hydraulic controls should they be accidentally moved. If the lever is not set to the "LOCKED" position and hydraulic controls are touched accidentally, the machine may move suddenly resulting in serious injury.

Also before leaving the machine, lower the bucket to the ground, place the safety lock lever in the "LOCKED" (Up) position, stop the engine and remove the starter switch key. **DO NOT BYPASS THE MACHINE'S SAFETY LOCK LEVER SYSTEM. THE MACHINE'S SAFETY LOCK LEVER SYSTEM MUST BE REPAIRED IF IT MALFUNCTIONS.**

K. SIGNS, SIGNALS & FLAGMEN

Install signs on soft shoulders and ground areas, have a flagman direct the operation if necessary. The operator should note marks and follow signals from the flagman. All personnel should know the meaning of the signs, marks, and signals. Only one flagman should give the signs and signals.

L. KEEP FIRE AWAY FROM FUEL AND OIL

Oil, antifreeze, and especially fuel are highly flammable. Never use fire near the machine. Securely tighten all fuel and oil caps. Keep fuel and oil in the designated storage areas. Promptly clean up any all spills and dispose of waste properly.

M. USE CAUTION NEAR NOISE

If noise is high during operation, hearing loss may result. Approved hearing protection should be used if personnel will be exposed to high noise levels for a long period of time.

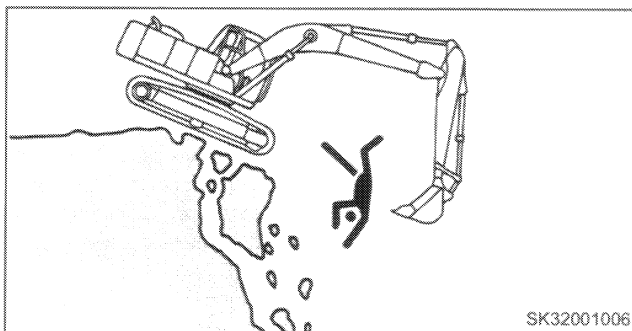

WORKSITE SAFETY- KNOW THE AREA

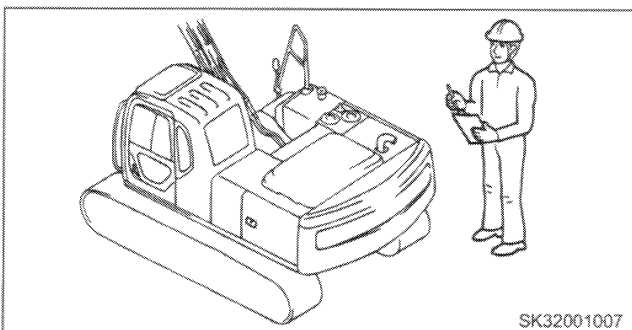

PRE-START INSPECTION OF MACHINE

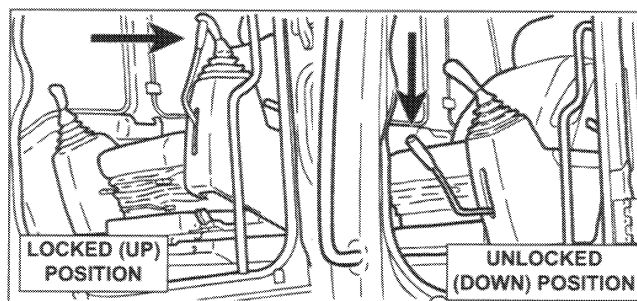

SAFETY LOCK LEVER



KEEP FIRE AWAY FROM FUEL & OIL

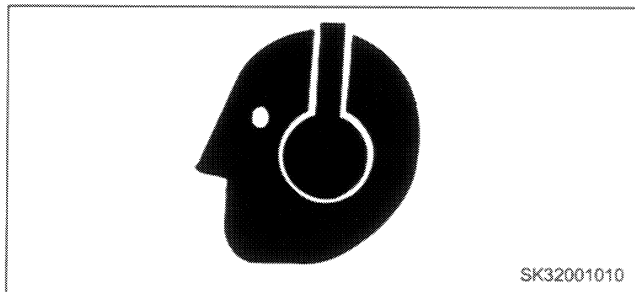

USE CAUTION NEAR NOISE

SAFETY PRECAUTIONS

N. MOUNTING & DISMOUNTING MACHINE

When getting on and off the machine, always maintain three point contact by using the handrails and step. Inspect and clean handrails, step, and mounting parts. Remove slippery materials, such as lubricants, and mud. Always place the cab door entrance parallel to the tracks before stopping the engine for dismounting. **DO NOT JUMP OFF THE MACHINE.**

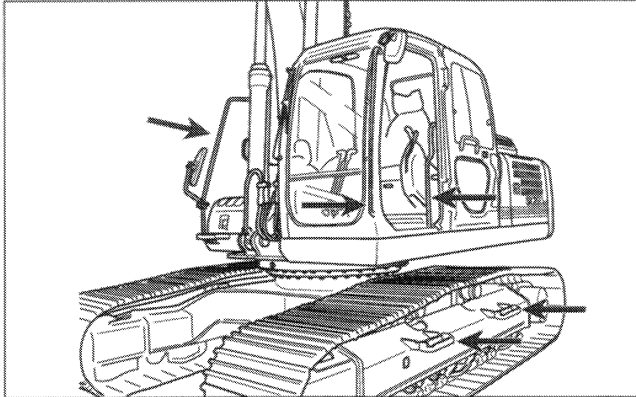

O. AVOID HOT SURFACES & AREAS

Immediately after the machine is operated, the temperature and pressure of the engine coolant, engine oil, and hydraulic oil are very high. Burns may result if caps are removed, or oil, water, or filters are changed under these conditions. Wait until the temperature goes down, before attempting to check fluids or change filters.

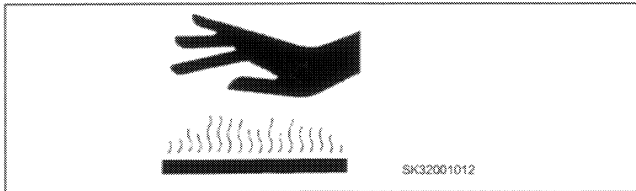

P. USE THE PROPER OPTIONAL ATTACHMENT

Use only optional attachments designed for and approved by KOBELCO. Read, understand and follow all instructions in the manual accompanying the optional attachment. Use of any optional attachment not approved by KOBELCO in writing, can cause serious injury to personnel, damage to the machine and its components and shorten the life of the machine. Contact an authorized KOBELCO Dealer for optional attachments available for the machine.

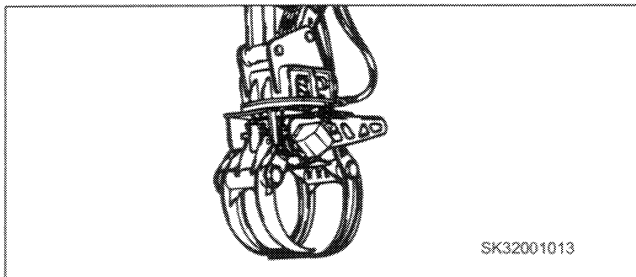

Q. PREVENT FIRES

Leaking or spilled fuel, lubricants and hydraulic oil are fire hazards. Clean and properly dispose of spills as they occur. Repair or replace all leaking components to prevent fire. Also, clean the machine regularly removing all debris to help prevent fires, pay particular attention to removal of leaves, sticks, paper etc. Keep fire extinguisher in an accessible area and know how to use the fire extinguisher should a fire occur.

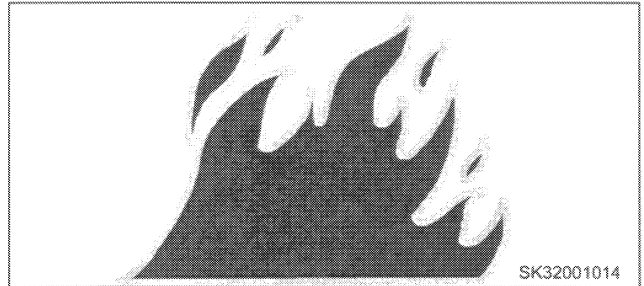

R. KEEP REARVIEW MIRRORS IN PLACE AND IN GOOD CONDITION

Before operating the machine, inspect and make sure all rearview mirrors are in place, in good condition, properly adjusted, and clean.

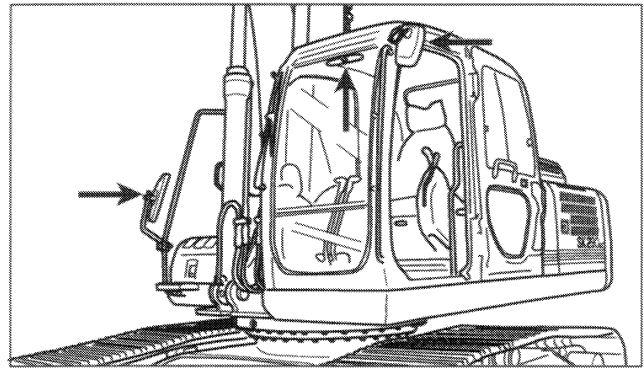

S. PROTECTIVE EQUIPMENT

When operating attachments that produce flying debris, it is highly recommended to procure and install protective guards on the machine and close all windows to protect the operator from flying debris. Also the operator and all personnel in the vicinity of the machine should wear protective gear such as safety shoes, hard hat, gloves and face shield or goggles.

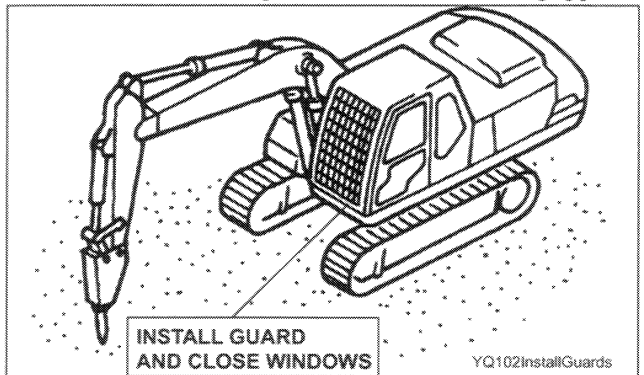



Suggest:

For more complete manuals. Please go to the home page.

<https://www.ebooklibonline.com>

If the above button click is invalid. Please download this document first, and then click the above link to download the complete manual.

Thank you so much for reading

SAFETY PRECAUTIONS

1.4 SAFETY DURING OPERATION

A. STARTING ENGINE

Start and operate the machine only from the operator's seat. Sound the horn before starting the engine to alert people the machine is being started. Make sure no one is near the machine. Do not short circuit the starter circuit or battery to start the engine. This may cause serious injury or cause damage the electrical system. Do not operate the engine in an enclosed area without adequate ventilation.

B. PASSENGERS

This equipment is not intended or designed for the transportation of persons. Never allow persons to ride on the machine. Serious injury or death can result from allowing passengers on or in the machine.

C. TRAVEL

Make certain of the location of the travel motors before operating travel controls. Sound horn before moving the machine to inform persons that the machine is travelling. Position the attachment as shown in illustration before beginning travel. Move the machine at slow speeds. Do not turn suddenly on rough terrain. Avoid travelling over obstacles. Should it become necessary to travel over an obstacle, keep the attachment low to the ground and travel at extremely slow speed. Do not dismount while the machine is in motion. Provide an escort where required.

D. SWING

Make certain the swing area of machine is clear of all persons and obstacles before operating swing controls. Sound horn before swinging machine. If necessary, have a flagman signal operator during operation to help prevent injury to persons or damage to obstacles and equipment.

E. BOOM, ARM & ATTACHMENTS

Give the work you are doing your undivided attention. Make certain the attachment being used is suited for the job at hand. Make certain of obstacles in the work area and operate the machine within those limits. If necessary have a flagman signal the operator to prevent injury to persons or damage to the machine or obstacles in the work area. ALWAYS PLACE ATTACHMENTS ON THE GROUND AND RAISE THE SAFETY LOCK LEVER BEFORE LEAVING THE CAB.

F. OPERATING ON INCLINES OR SLOPES

Operation of this machine on an incline or slope may cause the machine to become unstable or unbalanced. Work up and down inclines or slopes never across. Never Swing or turn machine around on slopes. Build a firm and stable, level, area for the machine to operate. Operate controls carefully to prevent sudden movements which may cause the machine to slide or tip over. Use a flagman to direct the operator.

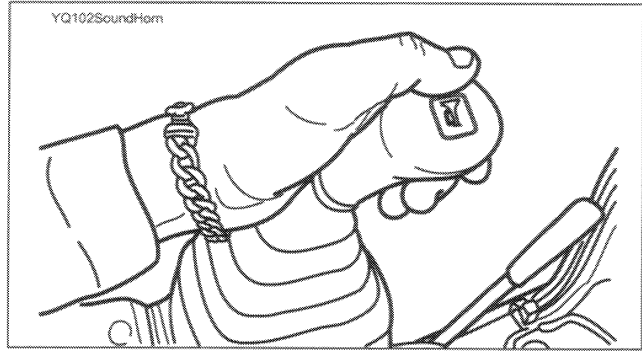

SOUND HORN BEFORE STARTING

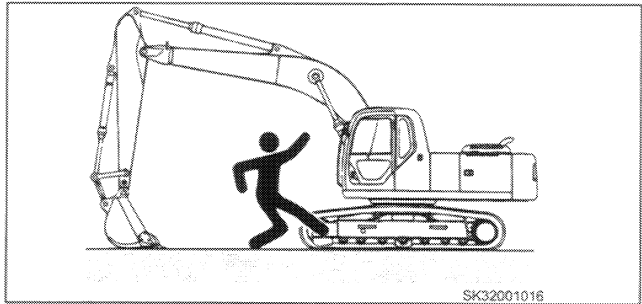

NO PASSENGERS

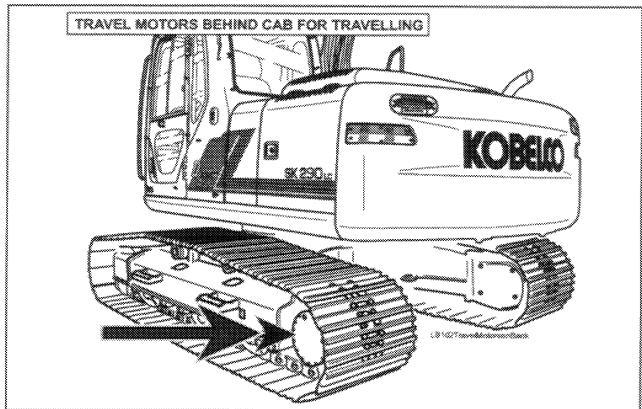

KNOW TRAVEL MOTOR POSITION

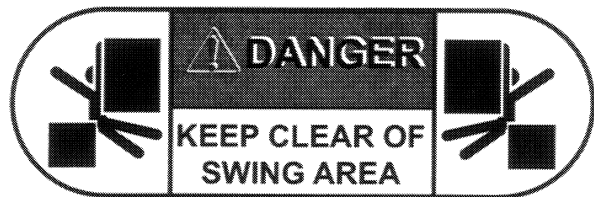

SWING SAFETY/USE SWING FLASHERS

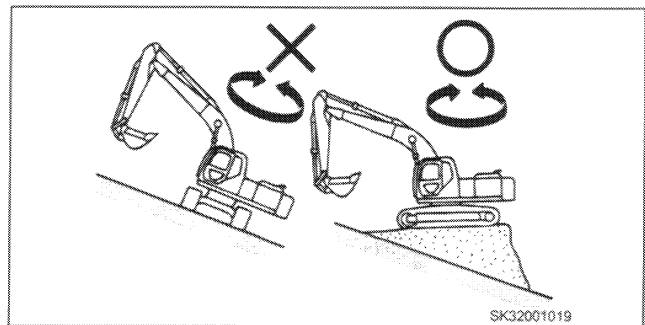

BUILD BANKING FOR SLOPE OPERATION

SAFETY PRECAUTIONS

1

G. WORKING AROUND UTILITIES

If it is suspected that utility lines such as, gas, water, phone or electrical power are in the work area, contact the local utility authority for line location BEFORE beginning work in the area. Use extreme caution around electrical power lines. Keep a sufficient distance away from electrical lines during operation. See chart below for minimum distances.

LINE VOLTAGE	MINIMUM DISTANCE- M(FEET)
0 ~ 50,000	3.0M (10) OR MORE
50,000 ~ 200,000	4.5M (15) OR MORE
200,000 ~ 350,000	6.0M (20) OR MORE
350,000 ~ 500,000	7.5M (25) OR MORE
500,000 ~ 750,000	10.5M (35) OR MORE
750,000 ~ 1,000,000	13.5M (45) OR MORE

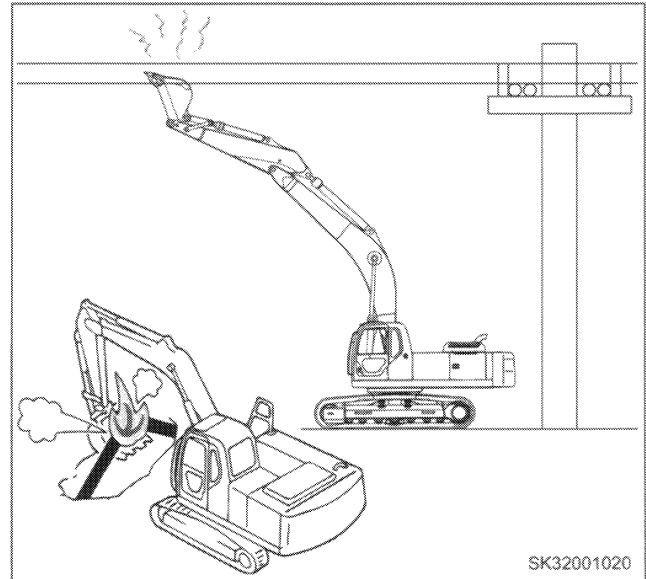

SK32001020

KEEP A SAFE DISTANCE FROM UTILITIES

H. LIFTING

This machine is an excavator. Use extreme caution when lifting or moving heavy loads. Use proper lifting equipment rated at a capacity to handle the load. **NEVER USE BUCKET TEETH TO LIFT OR MOVE HEAVY LOADS.**

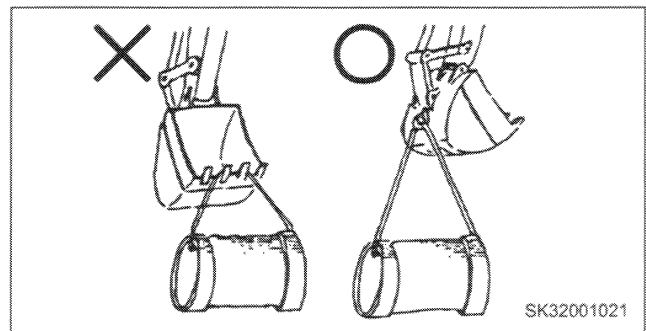

SK32001021

USE PROPER LIFTING DEVICES

I. FROZEN & SNOW COVERED WORK SITES

Use extreme caution when operating the machine on frozen or snow covered work sites. Operate all controls slowly and cautiously to prevent sudden movements that may cause the machine to unexpectedly shift, slide or move. Even on the slightest slope, when snow is present or work area is frozen can allow a machine to unexpectedly move. Snow on shoulders or snow drifts can be much deeper than expected. The machine can easily become buried under such conditions. Use extreme caution while operating the machine around or in snow.

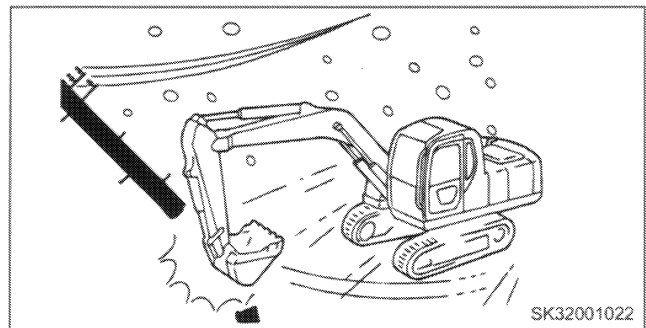

SK32001022

USE EXTREME CAUTION ON ICE OR SNOW

J. FILLED OR UNSTABLE GROUND

Be certain the condition of the work site is stable and capable of supporting the machine during operation. Do not operate attachment too close to the machine. Operation of the machine on shoulders or filled areas could cause the machine to become unstable presenting a work hazard. Position the travel motors to the rear of the machine, allowing for quick reversal, should the work area become unstable.

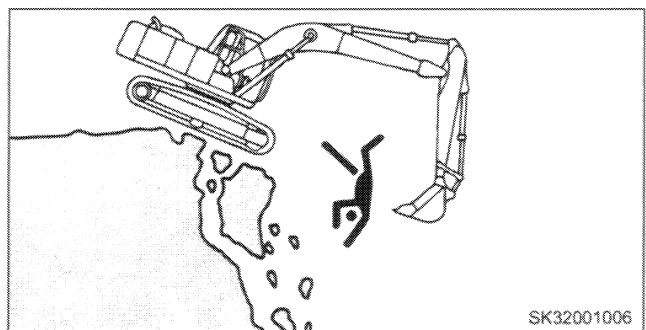

SK32001006

WORK ON STABLE GROUND

<https://www.ebooklibonline.com>

Hello dear friend!

Thank you very much for reading.

Enter the link into your browser.

The full manual is available for immediate download.

<https://www.ebooklibonline.com>