

**KOBELCO**

**SERVICE MANUAL**

**ISUZU INDUSTRIAL DIESEL ENGINE**

**K904 II**

**K905LC II**

# HYDRAULIC EXCAVATOR

**SHOP  
MANUAL**

**model**

**MD300 E**

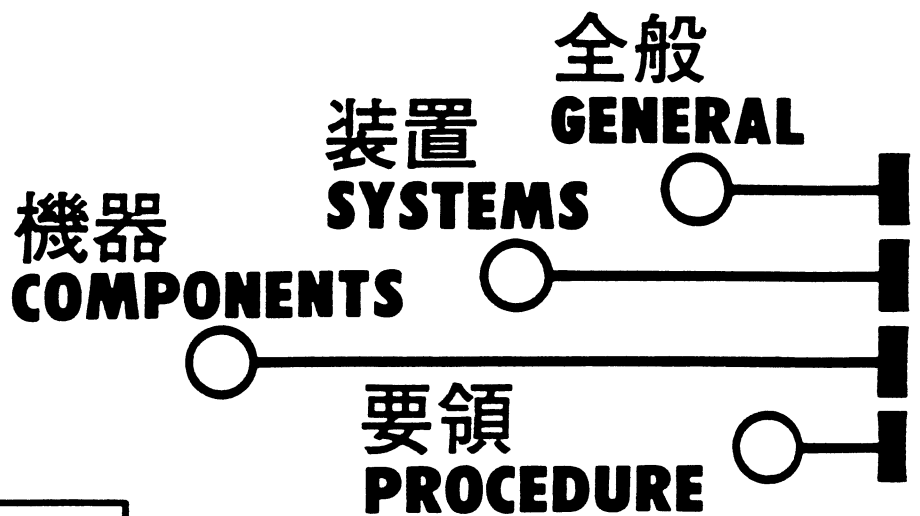

**MDI/YUTANI**

Book code No. S5YC0001E①

# **K904II-K905LcII**

## **ENGINE SHOP MANUAL**

# **WORKSHOP MANUAL**

# **4BD1**



**ISUZU MOTORS LIMITED**

**<https://www.ebooklibonline.com>**

Hello dear friend!

Thank you very much for reading.

Enter the link into your browser.

The full manual is available for immediate download.

**<https://www.ebooklibonline.com>**

**ISUZU**  
**WORKSHOP MANUAL**  
**INDUSTRIAL**  
**DIESEL ENGINE**  
**4B-6B SERIES**  
**4BB1-4BD1-6BB1-6BD1-6BG1**  
**4BD1T-6BD1T-6BG1T**  
**MODELS**

**FOREWORD**

This Workshop Manual is designed to help you perform necessary maintenance, service, and repair procedures on applicable Isuzu industrial engines.

Information contained in this Workshop Manual is the latest available at the time of publication.

Isuzu reserves the right to make changes at any time without prior notice.

The Table of Contents at the right hand side of this page shows you the general arrangement of the material in this Workshop Manual. A more detailed Table of Contents precedes each individual section.

The black spot at the right hand side of some pages indicates the first page of a given section.

This Workshop Manual is applicable to 1986 and later models.

**TABLE OF CONTENTS**

SECTION	NAME
<b>1</b>	GENERAL INFORMATION
<b>2</b>	MAINTENANCE
<b>3</b>	ENGINE ASSEMBLY I (DISASSEMBLY)
<b>4</b>	ENGINE ASSEMBLY II (INSPECTION & REPAIR)
<b>5</b>	ENGINE ASSEMBLY III (REASSEMBLY)
<b>6</b>	LUBRICATING SYSTEM
<b>7</b>	COOLING SYSTEM
<b>8</b>	FUEL SYSTEM
<b>9</b>	TURBOCHARGER
<b>10</b>	AIR COMPRESSOR
<b>11</b>	ENGINE ELECTRICALS
<b>12</b>	TROUBLESHOOTING
<b>13</b>	SPECIAL TOOL LIST
<b>14</b>	CONVERSION TABLE

## SECTION 1

## GENERAL INFORMATION

## TABLE OF CONTENTS

ITEM	PAGE
General repair instructions .....	1— 2
Notes on the format on this manual .....	1— 2
Main data and specifications .....	1— 6
Design features and general outline .....	1— 9
Tightening torque specifications .....	1—12
Angular nut and bolt tightening method .....	1—13
Major parts fixing nuts and bolts .....	1—15
Identifications .....	1—26

## **GENERAL REPAIR INSTRUCTIONS**

1. Before performing any service operation with the engine mounted, disconnect the grounding cable from the battery.  
This will reduce the chance of cable damage and burning due to short circuiting.
2. Always use the proper tool or tools for the job at hand.  
Where specified, use the specially designed tool or tools.
3. Use genuine ISUZU parts referring ISUZU PARTS CATALOG for the engines surely.
4. Never reuse cotter pins, gaskets, O-rings, lock washers, and self locking nuts. Discard them as you remove them. Replace them with new ones.
5. Always keep disassembled parts neatly in groups. This will ensure a smooth reassembly operation.  
It is especially important to keep fastening parts separate. These parts vary in hardness and design, depending on their installation position.
6. All parts should be carefully cleaned before inspection or reassembly.  
Oil ports and other openings should be cleaned with compressed air to make sure that they are completely free of obstructions.
7. Rotating and sliding part surfaces should be lubricated with oil or grease before reassembly.
8. If necessary, use a sealer on gaskets to prevent leakage.
9. Nut and bolt torque specifications should be carefully followed.
10. Always release the air pressure from any machine-mounted air tank(s) before dismantling the engine or disconnecting pipes and hoses. To not do so is extremely dangerous.
11. Always check and recheck your work. No service operation is complete until you have done this.
12. Information contained in the "Main Data and Specifications" of the Workshop Manual and the Instruction Book may differ. In this case, the information contained in the Instruction Book should be considered applicable.

## **NOTES ON THE FORMAT OF THIS MANUAL**

This Workshop Manual is applicable to the 4BB1, 4BD1, 4BD1T, 6BB1, 6BD1, 6BD1T, 6BG1, and 6BG1T family of industrial diesel engines. Unless otherwise specified, these engines have common parts and components as well as data and specifications.

Illustrations used in this Workshop Manual are based on the 6BD1 and 6BD1T engines.

The 4BD1T, 6BD1T and the 6BG1T engine are turbocharged.

1. Find the applicable section by referring to the Table of Contents at the beginning of the Manual.
2. Common technical data such as general maintenance items, service specifications, and tightening torques are included in the "General Information" section.
3. Each section is divided into sub-sections dealing with disassembly, inspection and repair, and reassembly.  
The section ENGINE ASSEMBLY is an exception. This part is divided into three sections to facilitate quick indexing.
4. When the same servicing operation is applicable to several different units, the manual will direct you to the appropriate page.
5. For the sake of brevity, self-explanatory removal and installation procedures are omitted.  
More complex procedures are covered in detail.

6. Each service operation section in this Workshop Manual begins with an exploded view of the applicable area. A brief explanation of the notation used follows.

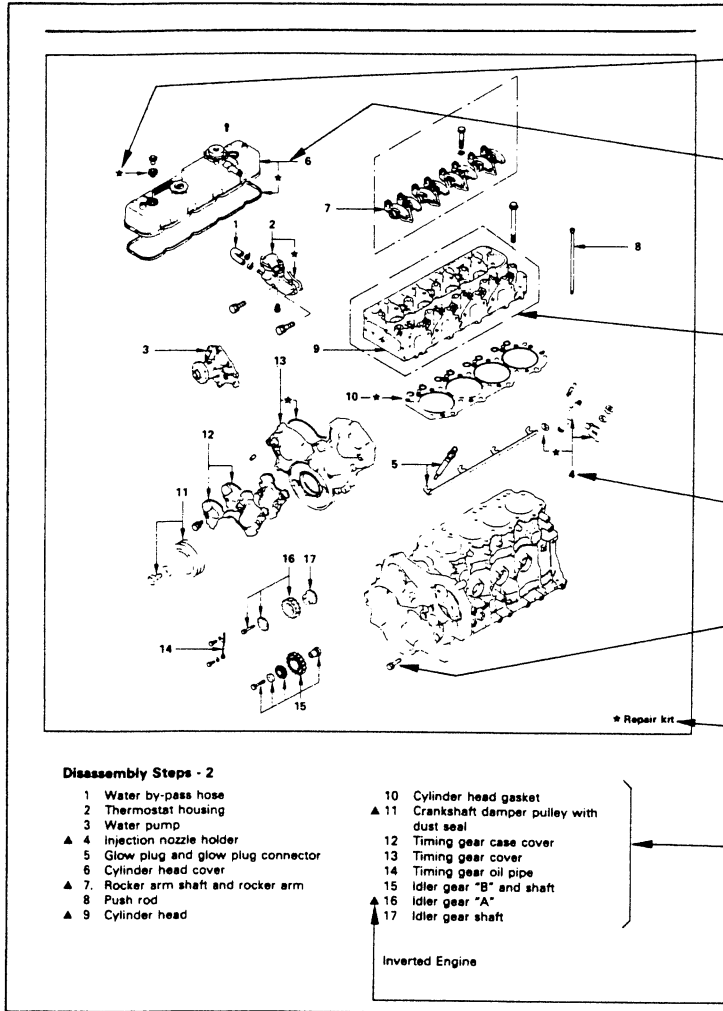

- Parts marked with an asterisk (\*) are included in the repair kit.
- Parts within a square frame are to be removed and installed as a single unit.
- All parts within an irregularly shaped frame form a single assembly. They are considered a "major component".
- Individual parts within the irregularly shaped frame are considered "minor components".
- The number tells you the service operation sequence.
- Removal of unnumbered parts is unnecessary unless replacement is required.
- The "\* Repair Kit" indicates that a repair kit is available.
- The parts listed under "Reassembly Steps" or "Installation Steps" are in the service operation sequence.
- The removal or installation of parts marked with a triangle (▲) is an important operation. Detailed information is given in the text.

## 1-4 GENERAL INFORMATION

7. Below is a sample of the text of the Workshop Manual.

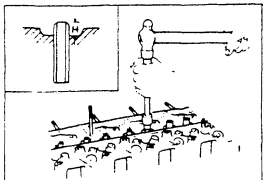

**Valve Guide Installation**

- 1 Lubricate the valve guide outer face with engine oil
- 2 Attach the installer to the valve guide.
- 3 Use a hammer to drive the valve guide into position from the cylinder head upper face
- 4 Measure the height of the valve guide upper end from the upper face of the cylinder head

Valve Guide Installer: 1-85220-001-0

Valve Guide Upper End Height (H)	14.1 (0.56)
----------------------------------	-------------

**Note:**  
If the valve guide has been removed, both the valve and the valve guide must be replaced with new ones as a set.  
Be absolutely sure to discard the used valves and valve guides

This is the item shown in the illustration. It is marked with a triangle (▲) on the Major Components page.

















Special tools are identified by the tool name and/or number.  
The illustration shows how the special tool is to be used.

Letters and numbers contained in a circle refer to the illustration.

Symbols indicate the type of service operation or step to be performed. A detailed explanation of these symbols follows.

Service data and specifications are given in this table.

8. The following symbols appear throughout this Workshop Manual. They tell you the type of service operation or step to perform.

 .... Removal	 .... Adjustment
 .... Installation	 .... Cleaning
 .... Disassembly	 .... Important Operation Requiring Extra Care
 .... Reassembly	 .... Specified Torque (Tighten)
 .... Alignment (Marks)	 .... Special Tool Use Required or Recommended (Isuzu Tool or Tools)
 .... Directional Indication	 .... Commercially Available Tool Use Required or Recommended
 .... Inspection	 .... Lubrication (Oil)
 .... Measurement	 .... Lubrication (Grease)
 .... Liquid Gasket Application	

9. Measurement criteria are defined by the terms “standard” and “limit”.

A measurement falling within the “standard” range indicates that the applicable part or parts are serviceable.

“Limit” should be thought of as an absolute value.

A measurement which is outside the “limit” indicates that the applicable part or parts must be either repaired or replaced.

10. Components and parts are listed in the singular form throughout the Manual.

11. Directions used in this Manual are as follows:

**Front**

The cooling fan side of the engine viewed from the flywheel.

**Right**

The injection pump side of the engine.

**Left**

The exhaust manifold side of the engine.

**Rear**

The flywheel side of the engine.

Cylinder numbers are counted from the front of the engine.

The front most cylinder is No. 1 and rear most cylinder is No. 4 or No. 6.

The engine’s direction of rotation is counterclockwise viewed from the flywheel.

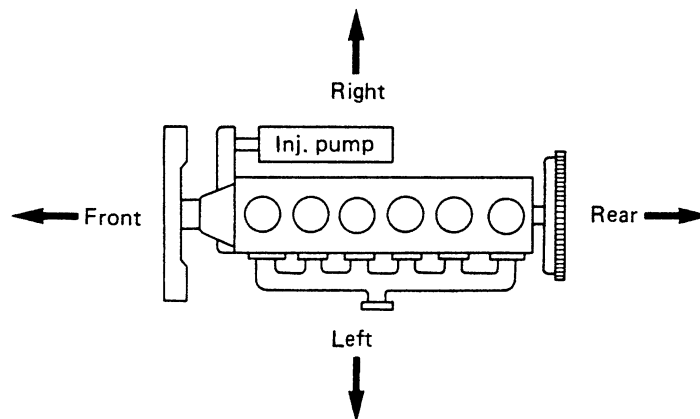

## MAIN DATA AND SPECIFICATIONS

Engine Model		4BB1	4BD1	4BD1T
Item				
Engine type		Water cooled, four cycle, vertical in-line, overhead valve		
Combustion chamber type		Direct injection		
Cylinder liner type		Dry		
No. of cylinders — bore × stroke	mm(in)	4—102.0×110.0 (4.02×4.33)	4 — 102.0 × 118.0 (4.02 × 4.65)	
Total piston displacement	cm <sup>3</sup> (in <sup>3</sup> )	3,595 (219)	3,856 (235)	
Compression ratio (To 1)		17.5		
*Engine dimensions	mm(in)	842×645×775 (33.1×25.4×30.5)	842×645×775 (33.1×25.4×30.5)	810×690×856 (31.9×27.2×33.7)
Length × width × height				
*Engine weight (Dry)	kg(lb)	325 (716)	325 (716)	340 (750)
Fuel injection order		1 — 3 — 4 — 2		
Specified fuel		Diesel fuel (ASTM D975 No. 2D)		
Injection pump		In-line plunger, Bosch A type		
Governor		Mechanical, RSV type		
Injection nozzle		Multi hole		
*Injection starting pressure	kg/cm <sup>2</sup> (psi)	150 (2,133), or 185 (2,630)		185 (2,630)
Fuel filter type		Center bolt or cartridge (spin-on)		
Water sedimentor (if so equipped)		Sediment/water level indicating type		
Compression pressure (At warm)	kg/cm <sup>2</sup> (psi)	31 (441) at 200 rpm at sea level		
Valve clearances (At cold)	Intake mm(in)	0.40 (0.016)		
	Exhaust mm(in)	0.40 (0.016)		
Lubrication method		Pressurized circulation		
Oil pump		Gear type		
Main oil filter type		Center bolt, full flow or cartridge (spin-on)		
*Lubricating oil capacity	lit(US/UK gal)	13 (3.44/2.86)		
Oil cooler		Water cooled integral type		
Cooling method		Pressurized forced circulation		
Coolant capacity (engine only)	lit(US/UK gal)	8.5 (2.25/1.87)		
Water pump		Belt driven impeller type		
Thermostat type		Wax pellet type		
*Alternator	V-A	24 — 15		
*Starter	V-KW	24 — 3.5		
*Turbocharger manufacturer		—	—	IHI
*Turbocharger model		—	—	RHB6A

- Note:** 1. These specifications are based on the standard engine.  
2. Specifications for items marked with an asterisk (\*) will vary according to the type of equipment on which the engine is installed.  
If you are unable to locate the data applicable to these specifications, please contact Isuzu Motors LTD through your machine supplier.

## MAIN DATA AND SPECIFICATIONS

Engine Model		6BB1	6BD1	6BD1T
Item				
Engine type		Water cooled, four cycle, vertical in-line, overhead valve		
Combustion chamber type		Direct injection		
Cylinder liner type		Dry		
No. of cylinders — bore × stroke	mm(in)	6—102.0×110.0 (4.02×4.33)	6 — 102.0 × 118.0 (4.02 × 4.65)	
Total piston displacement	cm <sup>3</sup> (in <sup>3</sup> )	5,394 (329)	5,785 (353)	
Compression ratio (To 1)		17.5		
*Engine dimensions	mm(in)	1122×648×775 (44.1×25.5×30.5)	1122×648×775 (44.1×25.5×30.5)	1132×680×883 (44.6×26.8×34.8)
Length × width × height				
*Engine weight (Dry)	kg(lb)	450 (992)	450 (992)	497 (1096)
Fuel injection order		i — 5 — 3 — 6 — 2 — 4		
Specified fuel		Diesel fuel (ASTM D975 No. 2D)		
Injection pump		In-line plunger, Bosch A type		
Governor		Mechanical, RSV type		
Injection nozzle		Multi hole		
*Injection starting pressure	kg/cm <sup>2</sup> (psi)	150 (2,133), or 185 (2,630)		185 (2,630)
Fuel filter type		Center bolt or cartridge (spin-on)		
Water sedimentor (if so equipped)		Sediment/water level indicating type		
Compression pressure (At warm)	kg/cm <sup>2</sup> (psi)	31 (441) at 200 rpm at sea level		
Valve clearances (At cold)	Intake mm(in)	0.40 (0.016)		
	Exhaust mm(in)	0.40 (0.016)		
Lubrication method		Pressurized circulation		
Oil pump		Gear type		
Main oil filter type		Center bolt, full flow or cartridge (spin-on)		
*Lubricating oil capacity	lit(US/UK gal)	13 (3.44/2.86)		
Oil cooler		Water cooled integral type		
Cooling method		Pressurized forced circulation		
Coolant capacity (engine only)	lit(US/UK gal)	12.0 (3.2/2.6)		
Water pump		Belt driven impeller type		
Thermostat type		Wax pellet type		
*Alternator	V-A	24 — 25		
*Starter	V-KW	24 — 4.5		
*Turbocharger manufacturer		—	—	IHI
*Turbocharger model		—	—	RHB7 or RHC7

- Note:** 1. These specifications are based on the standard engine.  
2. Specifications for items marked with an asterisk (\*) will vary according to the type of equipment on which the engine is installed.  
If you are unable to locate the data applicable to these specifications, please contact Isuzu Motors LTD through your machine supplier.

MAIN DATA AND SPECIFICATIONS

Engine Model		6BG1	6BG1T
Item			
Engine type		Water cooled, four cycle, vertical in-line, overhead valve	
Combustion chamber type		Direct injection	
Cylinder liner type		Dry	
No. of cylinders — Bore × stroke	mm(in)	6 — 105.0 × 125.0 (4.13 × 4.92)	
Total piston displacement	cm <sup>3</sup> (in <sup>3</sup> )	6,494 (396)	
Compression ratio (To 1)		17	
*Engine dimensions	mm(in)	1122 × 648 × 775	1132 × 672 × 875
Length × width × height		(44.2 × 25.5 × 30.5)	(44.6 × 26.5 × 34.4)
*Engine weight (Dry)	kg(lb)	458 (1009)	505 (1112)
Fuel injection order		1 — 5 — 3 — 6 — 2 — 4	
Specified fuel		Diesel fuel (ASTM D975 No. 2D)	
Injection pump		In-line plunger, Bosch A type	
Governor		Mechanical, RSV type	
Injection nozzle		Multi hole	
Injection starting pressure	kg/cm <sup>2</sup> (psi)	185 (2,630)	
Fuel filter type		Cartridge (spin-on)	
Water sedimentor	(if so equipped)	Sedimenter/water level indicating type	
Compression pressure	kg/cm <sup>2</sup> (psi)	31 (441) at 200 rpm at sea level	
Valve clearances (At cold)	Intake mm(in)	0.40 (0.016)	
	Exhaust mm(in)	0.40 (0.016)	
Lubrication method		Pressurized circulation	
Oil pump		Gear type	
Main oil filter type		Centerbolt, fullflow or cartridge (spin-on)	
Partial oil filter		Equipped by OEM	
*Lubricating oil capacity	lit(US/UK gal)	13 (3.44/2.86)	
Oil cooler		Water cooled integral type	
Cooling method		Pressurized forced circulation	
Coolant capacity (engine only)	lit(US/UK gal)	12 (3.2/2.6)	
Water pump		Belt driven impeller type	
Thermostat type		Wax pellet type	
*Alternator	V-A	24 — 25	
*Starter	V-KW	24 — 4.5	
*Turbocharger manufacturer		—	IHI
*Turbocharger model		—	RHB7 or RHC7

**Note:** 1. These specifications are based on the standard engine.  
 2. Specifications for items marked with an asterisk (\*) will vary according to the type of equipment on which the engine is installed.  
 If you are unable to locate the data applicable to these specifications, please contact Isuzu Motors LTD through your machine supplier.

## DESIGN FEATURES AND GENERAL OUTLINE

### 1. General Outline of ISUZU 4B and 6B Series Diesel Engines

Industrial diesel engines offering high performance and durability as well as maximum operating economy are in great demand in today's energy conscious world. ISUZU 4B and 6B series industrial diesel engines are specifically designed to meet this demand.

4B and 6B engines have either four or six cylinders. All models are vertical in-line, four stroke, water-cooled engines with direct fuel injection.

4BD1T, 6BD1T and 6BG1T engines are turbocharger equipped.

4B and 6B engines feature the unique ISUZU troidal square combustion chamber. This design provides superior fuel economy for varied industrial applications.

### 2. Main Engine Parts and Their Function

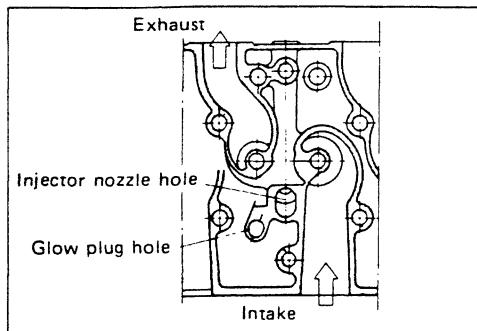

#### 1) Cylinder Head

The engine uses a mono-block cylinder head with alternately arranged independent intake and exhaust ports.

Helical flow intake ports generate a very stable intake swirl.

Sectionally shaped exhaust ports minimize exhaust resistance.

A laminated steel sheet cylinder head gasket eliminates the need for cylinder head bolt retightening. This type of gasket provides high durability and maximum service economy.

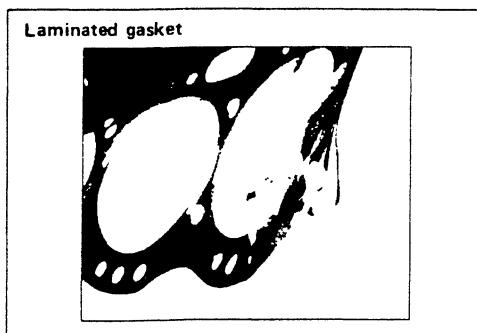

Cut away view of No. 4 journal

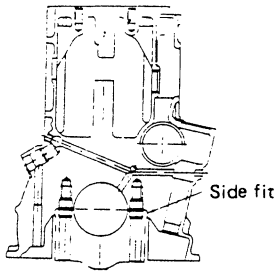

For 6BB1/6BD1 models

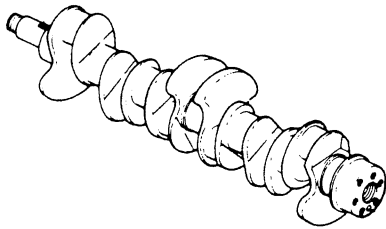

### 2) Cylinder Body

A cast iron mono-block cylinder body provides optimum rigidity around the crankcase.

4BD1T, 6BD1T and 6BG1T turbocharger equipped engines have piston cooling oil jets at the bottom of each cylinder. Piston thermal load is minimized to provide high durability.

Chrome plated dry type cylinder liners are used. This type of cylinder liner has a proven reputation for high durability.

The liner is made from 1.5 mm and 1 mm (6BG1) thick steel piping. The bore surfaces are plated with chrome. The chrome has countless microscopic pores.

### 3) Crankshaft

The crankshaft is a special steel one-piece precision forging. Six cylinder engines have seven crankshaft support bearings and four cylinder engines have five.

Pins and journals for non-turbocharged engines (without 6BG1) are machined with a fillet-rolling technique.

Pins and journals for turbocharged engines and 6BG1 engine are tufftrided to increase their fatigue strength.

The crankshaft pulley on 6B series engines is securely coupled to the crankshaft front end with a taper bushing.

Crankshaft counterweights minimize engine dynamic imbalance.

Front and rear crankshaft end oil seals are lipped. Scroll threads are cut into the sealing surface.

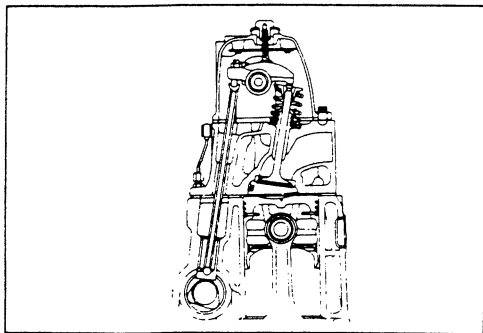
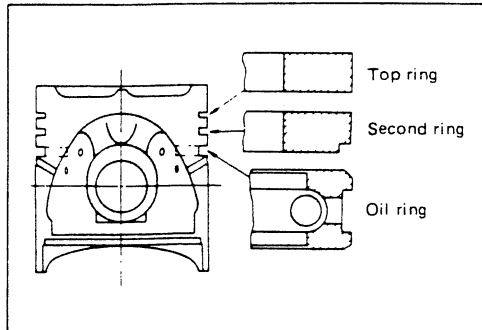
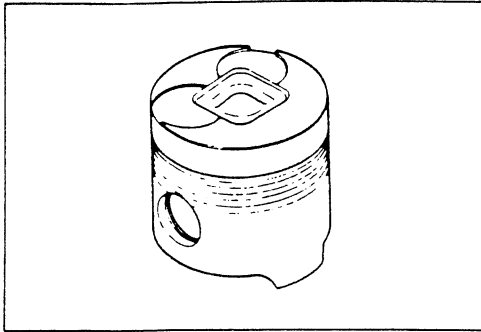

#### 4) Pistons

The tapered slipper pistons are constructed from Low-ex aluminum alloy.

The piston skirt is cut at a right angle to prevent side thrust from being applied to the piston flank. This also reduces piston weight and friction area.

The head of the piston forms a square combustion chamber. Ideal combustion is provided at all engine operating speeds.

Turbocharged B series and 6BG1 engines have a special ring trigger cast into the top piston ring groove. This improves the ring groove's anti-wear characteristics.

Each piston has two compression rings and one oil ring.

The compression rings have an mark at the top to indicate direction of installation.

The piston rings are made of special cast iron which provides superior durability.

The top compression ring has hard chrome plated on the top, bottom, and back surfaces. The ring is not chamfered.

The second compression ring is tapered and continuously undercut.

The oil ring has a coil expander.

#### 5) Valve Mechanism

All engines use a standard overhead valve configuration.

6B series engines have six bearings supporting the camshaft and 4B series engines have four.

The bearings pressed into the camshaft holes in the cylinder body.

An oil pump drive gear is installed to the camshaft center.

Tappets are made of special cast iron. The tappet driven surface has a chilled layer coated with phosphate film. This provides superior initial conforming.

Rocker arms are also made of special cast iron with a chilled rocker surface layer.



**Suggest:**

**For more complete manuals. Please go to the home page.**

**<https://www.ebooklibonline.com>**

**If the above button click is invalid. Please download this document first, and then click the above link to download the complete manual.**

**Thank you so much for reading**



## TIGHTENING TORQUE SPECIFICATIONS



### STANDARD BOLTS

The torque values given in the following table should be applied where a particular torque is not specified.

kg·m(ft.lb)

Bolt identification  Material  Bolt diameter x pitch (mm)			
	4T (Low carbon steel)	7T (High carbon steel)	9T (Alloy steel)
<b>M 6 × 1.0</b>	0.6 ±0.2 ( 4.4± 1.4)	0.75± 0.2 ( 5.43± 1.43)	—
<b>M 8 × 1.25</b>	1.3 ±0.5 ( 0.4± 3.4)	1.75± 0.5 ( 12.66± 3.00)	2.0 ± 0.7 ( 17.36± 5.36)
<b>M10 × 1.25</b>	2.8 ±0.7 ( 20.3± 5.2)	3.75± 0.9 ( 27.20± 7.2 )	5.0 ± 1.3 ( 36.88± 9.88)
<b>M12 × 1.25</b>	6.25±1.2 ( 45.2± 9.2)	7.75± 1.5 ( 56.03± 11.03)	9.65± 1.9 ( 69.77± 13.77)
<b>M14 × 1.5</b>	8.75±1.9 ( 70.5±14.5)	11.85± 2.3 ( 85.67± 16.6 )	14.50± 2.9 (104.84± 20.83)
<b>M16 × 1.5</b>	13.3 ±2.7 ( 94.0±17.0)	17.30± 3.5 (125.07± 25.07)	20.40± 4.1 (147.50± 29.49)
<b>M18 × 1.5</b>	19.2 ±3.8 (138.9±27.9)	24.90± 5.0 (180.03± 36.3 )	29.30± 5.9 (211.84± 42.83)
<b>M20 × 1.5</b>	26.3 ±5.3 (190.2±38.2)	34.40± 6.9 (248.72± 49.7 )	40.40± 8.1 (292.10± 58.09)
<b>M22 × 1.5</b>	33.0 ±8.3 (245.1±60.1)	46.25± 9.2 (334.39± 66.38)	54.10±10.8 (391.15± 78.14)
<b>M24 × 2.0</b>	45.8 ±9.2 (331.2±60.2)	58.20±14.0 (420.70±102.78)	70.60±14.1 (510.44±101.44)
<b>*M10 × 1.5</b>	2.7 ±0.7 ( 19.6± 5.6)	3.7 ± 0.9 ( 26.75± 6.7 )	4.9 ± 1.2 ( 35.43± 8.42)
<b>*M12 × 1.5</b>	5.8 ±1.2 ( 42.0± 9.0)	7.2 ± 1.4 ( 52.05± 10.05)	9.1 ± 1.8 ( 65.80± 12.80)
<b>*M14 × 2.0</b>	9.1 ±1.8 ( 65.8±12.8)	11.2 ± 2.2 ( 80.97± 15.7 )	13.6 ± 2.7 ( 98.33± 19.33)
<b>*M16 × 2.0</b>	12.7 ±2.5 ( 91.9±17.9)	16.5 ± 3.3 (119.30± 24.3 )	19.5 ± 3.9 (140.99± 27.99)

**Note:**

Bolts marked with an asterisk (\*) are used for female threaded parts made of soft materials such as casting.



# ANGULAR NUT AND BOLT TIGHTENING METHOD



1. Carefully wash the nuts and bolts to remove all oil and grease.

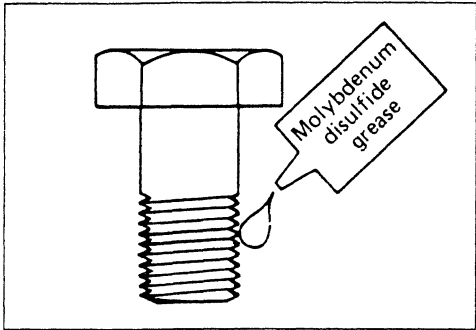

2. Apply a coat of molybdenum disulfide grease to the threads and setting faces of the nuts and bolts.

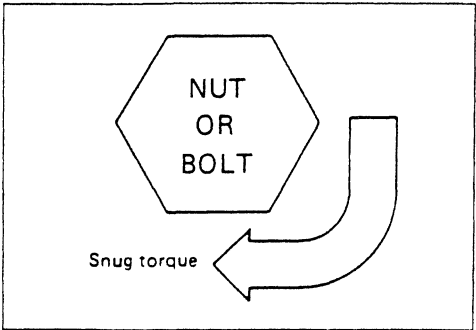

3. Tighten the nuts and bolts to the specified torque (snug torque) with a torque wrench.

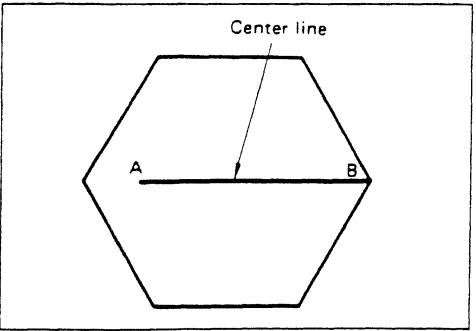

4. Draw a line [A-B] across the center of each bolt.

**<https://www.ebooklibonline.com>**

Hello dear friend!

Thank you very much for reading.

Enter the link into your browser.

The full manual is available for immediate download.

**<https://www.ebooklibonline.com>**