

DCI33
DCI63
Disc Mower Conditioner

SERVICE MANUAL

Part number 48049005

2nd edition English

November 2016

Replaces part number 47544205

CASE II
AGRICULTURE



SERVICE MANUAL

**DC133
DC163**

Contents

INTRODUCTION

Power Take-Off (PTO)	31
[31.201] Power Take-Off (PTO) drive shaft	31.1
[31.214] Secondary Power Take-Off (PTO)	31.2
[31.215] Intermediate Power Take-Off (PTO)	31.3
[31.220] Gearbox	31.4
[31.225] Clutches	31.5
Hydraulic systems	35
[35.000] Hydraulic systems	35.1
[35.410] Header or attachment height system	35.2
[35.415] Header or attachment tilting system	35.3
[35.947] Frame positioning swinging	35.4
Wheels	44
[44.530] Carrying and transport wheels	44.1
Electrical systems	55
[55.000] Electrical system	55.1
[55.100] Harnesses and connectors	55.2
[55.404] External lighting	55.3
Attachments/Headers	58
[58.110] Attachment/Header cutting mechanism	58.1
[58.130] Attachment/Header frame	58.2
Product feeding	60
[60.120] Header drive system	60.1
[60.620] Roll conditioning	60.2
[60.630] Flail conditioning	60.3

<https://www.ebooklibonline.com>

Hello dear friend!

Thank you very much for reading.

Enter the link into your browser.

The full manual is available for immediate download.

<https://www.ebooklibonline.com>



INTRODUCTION

Contents

INTRODUCTION

Foreword - Important notice regarding equipment servicing	3
Safety rules	4
Safety rules - Personal safety	5
Safety rules - Ecology and the environment	10
Torque - Nominal tightening torques for normal assembly	11
Basic instructions - Shop and assembly	16
General specifications	18
Capacities	20
Product identification	22
Product identification - Machine orientation	23

Foreword - Important notice regarding equipment servicing

All repair and maintenance work listed in this manual must be carried out only by qualified dealership personnel, strictly complying with the instructions given, and using, whenever possible, the special tools.

Anyone who performs repair and maintenance operations without complying with the procedures provided herein shall be responsible for any subsequent damages.

The manufacturer and all the organizations of its distribution chain, including - without limitation - national, regional, or local dealers, reject any responsibility for damages caused by parts and/or components not approved by the manufacturer, including those used for the servicing or repair of the product manufactured or marketed by the manufacturer. In any case, no warranty is given or attributed on the product manufactured or marketed by the manufacturer in case of damages caused by parts and/or components not approved by the manufacturer.

The manufacturer reserves the right to make improvements in design and changes in specifications at any time without notice and without incurring any obligation to install them on units previously sold. Specifications, descriptions, and illustrative material herein are as accurate as known at time of publication but are subject to change without notice.

In case of questions, refer to your CASE IH Sales and Service Networks.

Safety rules

Personal safety





This is the safety alert symbol. It is used to alert you to potential personal injury hazards. Obey all safety messages that follow this symbol to avoid possible death or injury.

Throughout this manual you will find the signal words DANGER, WARNING, and CAUTION followed by special instructions. These precautions are intended for the personal safety of you and those working with you.

Read and understand all the safety messages in this manual before you operate or service the machine.

 DANGER indicates a hazardous situation that, if not avoided, will result in death or serious injury.

 WARNING indicates a hazardous situation that, if not avoided, could result in death or serious injury.

 CAUTION indicates a hazardous situation that, if not avoided, could result in minor or moderate injury.

FAILURE TO FOLLOW DANGER, WARNING, AND CAUTION MESSAGES COULD RESULT IN DEATH OR SERIOUS INJURY.

Machine safety

NOTICE: Notice indicates a situation that, if not avoided, could result in machine or property damage.

Throughout this manual you will find the signal word Notice followed by special instructions to prevent machine or property damage. The word Notice is used to address practices not related to personal safety.

Information

NOTE: Note indicates additional information that clarifies steps, procedures, or other information in this manual.

Throughout this manual you will find the word Note followed by additional information about a step, procedure, or other information in the manual. The word Note is not intended to address personal safety or property damage.

Safety rules - Personal safety

General safety rules

Use caution when you operate the machine on slopes. Raised equipment, full tanks and other loads will change the center of gravity of the machine. The machine can tip or roll over when near ditches and embankments or uneven surfaces.

Never permit anyone other than the operator to ride on the machine.

Never operate the machine under the influence of alcohol or drugs, or while you are otherwise impaired.

Hydraulic oil or diesel fuel leaking under pressure can penetrate the skin, causing serious injury or infection.

- DO NOT use your hand to check for leaks. Use a piece of cardboard or paper.
- Stop the engine, remove the key, and relieve the pressure before you connect or disconnect fluid lines.
- Make sure that all components are in good condition. Tighten all connections before you start the engine or pressurize the system.
- If hydraulic fluid or diesel fuel penetrates the skin, seek medical attention immediately.
- Continuous long term contact with hydraulic fluid may cause skin cancer. Avoid long term contact and wash the skin promptly with soap and water.

Keep clear of moving parts. Loose clothing, jewelry, watches, long hair, and other loose or hanging items can become entangled in moving parts.

Wear protective equipment when appropriate.

DO NOT attempt to remove material from any part of the machine while it is being operated or while components are in motion.

Make sure that all guards and shields are in good condition and properly installed before you operate the machine. Never operate the machine with shields removed. Always close access doors or panels before you operate the machine.

A person or pet within the operating area of a machine can be struck or crushed by the machine or its equipment. DO NOT allow anyone to enter the work area.

Raised equipment and/or loads can fall unexpectedly and crush persons underneath. Never allow anyone to enter the area underneath raised equipment during operation.

Always keep windows, mirrors, all lighting, and Slow-Moving Vehicle (SMV) emblem clean to provide the best possible visibility while you operate the machine.

Operate controls only when seated in the operator's seat, except for those controls expressly intended for use from other locations.

Before you leave the machine:

1. Park the machine on a firm, level surface.
2. Put all controls in neutral or park lock position.
3. Engage the parking brake. Use wheel chocks if required.
4. Lower all hydraulic equipment — Implements, header, etc.
5. Turn off the engine and remove the key.

⚠ WARNING

**Some components may continue to run down after you disengage drive systems.
Make sure all drive systems are fully disengaged.
Failure to comply could result in death or serious injury.**

W0113A

When, due to exceptional circumstances, you would decide to keep the engine running after you leave the operator's station, then you must follow these precautions:

1. Bring the engine to low idle speed.
2. Disengage all drive systems.
3. Shift the transmission into neutral.
4. Apply the parking brake.

⚠ General maintenance safety ⚠

Keep the area used for servicing the machine clean and dry. Clean up spilled fluids.

Service the machine on a firm, level surface.

Install guards and shields after you service the machine.

Close all access doors and install all panels after servicing the machine.

Do not attempt to clean, lubricate, clear obstructions, or make adjustments to the machine while it is in motion or while the engine is running.

Always make sure that working area is clear of tools, parts, other persons and pets before you start operating the machine.

Unsupported hydraulic cylinders can lose pressure and drop the equipment, causing a crushing hazard. Do not leave equipment in a raised position while parked or during service, unless the equipment is securely supported.

Jack or lift the machine only at jack or lift points indicated in this manual.

Incorrect towing procedures can cause accidents. When you tow a disabled machine follow the procedure in this manual. Use only rigid tow bars.

Stop the engine, remove the key, and relieve pressure before you connect or disconnect fluid lines.

Stop the engine and remove the key before you connect or disconnect electrical connections.

Replace damaged or worn tubes, hoses, electrical wiring, etc.

When welding, follow the instructions in the manual. Always disconnect the battery before you weld on the machine. Always wash your hands after you handle battery components.

⚠️ Wheels and tires ⚠️

Make sure that tires are correctly inflated. Do not exceed any recommended load or pressure. Follow the instructions in the manual for proper tire inflation.

Tires are heavy. Handling tires without proper equipment could cause death or serious injury.

Never weld on a wheel with a tire installed. Always remove the tire completely from the wheel prior to welding.

Always have a qualified tire technician service the tires and wheels. If a tire has lost all pressure, take the tire and wheel to a tire shop or your dealer for service. Explosive separation of the tire can cause serious injury.

DO NOT weld to a wheel or rim until the tire is completely removed. Inflated tires can generate a gas mixture with the air that can be ignited by high temperatures from welding procedures performed on the wheel or rim. Removing the air or loosening the tire on the rim (breaking the bead) will NOT eliminate the hazard. This condition can exist whether tires are inflated or deflated. The tire MUST be completely removed from the wheel or rim prior to welding the wheel or rim.

⚠️ Driving on public roads and general transportation safety ⚠️

Comply with local laws and regulations.

Use appropriate lighting to meet local regulations.

Make sure that the Slow-Moving Vehicle (SMV) emblem (1) is visible.

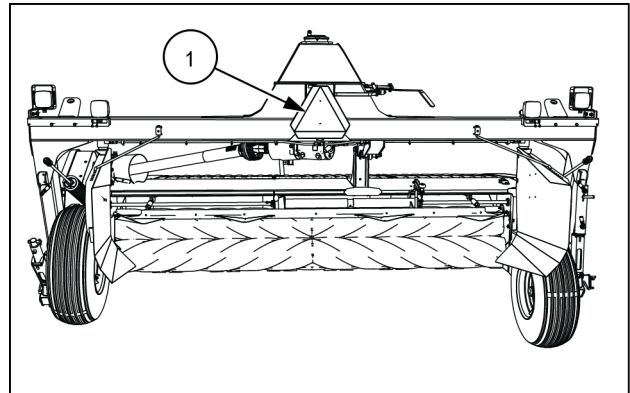

NHIL13HT00312AA 1

Make sure that the brake pedal latch is engaged. You must lock brake pedals together for road travel.

Use safety chains for trailed equipment when safety chains are provided with machine or equipment.

Lift implements and attachments high enough above ground to prevent accidental contact with road.

When you transport equipment or a machine on a transport trailer, make sure that it is properly secured. the Slow-Moving Vehicle (SMV) emblem on the equipment or machine is covered while being transported on a trailer.

Be aware of overhead structures or power lines and make sure that the machine and/or attachments can pass safely under.

Travel speed should be such that you maintain complete control and machine stability at all times.

Slow down and signal before turning.

Pull over to allow faster traffic to pass.

Follow correct towing procedure for equipment with or without brakes.

⚠ Power Take-Off (PTO) ⚠

Power Take-Off (PTO) driven machinery can cause death or serious injury. Before you work on or near the PTO shaft or service or clear the driven machine, put the PTO lever in the disengage position, stop the engine, and remove the key.

Whenever a PTO is in operation, a guard must be in place to prevent death or injury to the operator or bystanders.

When doing stationary PTO work, keep clear of all moving parts and make sure that appropriate guards are in place.

Never use a spline adaptor:

- Match the right tractor PTO spline and speed with the PTO drive shaft provided with an implement. This will assure proper geometry and operating speed.
- Never operate **540 RPM** implements at **1000 RPM**.
- Never operate **1000 RPM** implements at **540 RPM**.
- Use of PTO adaptors will void the warranty of the drive shaft, and the PTO drive train of the machine and implement.
- For correct hitch setup and geometry see the operator's manual for relevant hitch configuration on the machine:
 - See "Machine preparation – Two-point swivel hitch with tractor quick-hitch".
 - See "Tractor attachment – Two-point swivel hitch with tractor quick-hitch".
 - See "Tractor attachment – Two-point swivel hitch".
 - See "Machine preparation – Two-point swivel hitch".
 - See "Machine preparation – Drawbar swivel hitch".
 - See "Tractor attachment – Drawbar swivel hitch".

⚠ Reflectors and warning lights ⚠

You must use flashing amber warning lights **(1)** when you operate equipment on public roads.

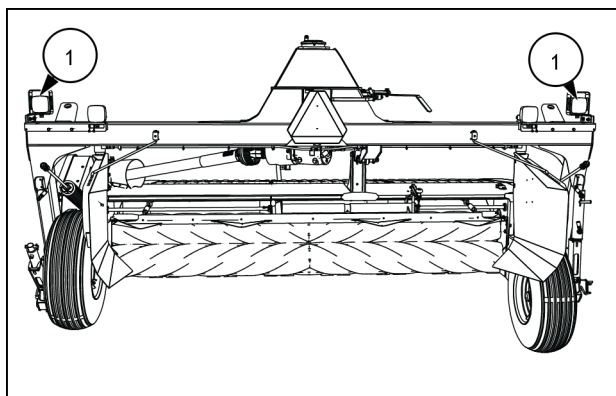

NHIL13HT00312AA 2

⚠ Personal Protective Equipment (PPE) ⚠

Wear Personal Protective Equipment (PPE) such as hard hat, eye protection, heavy gloves, hearing protection, protective clothing, etc.

⚠ Do Not Operate tag ⚠

Before you start servicing the machine, attach a 'Do Not Operate' warning tag to the machine in an area that will be visible.

⚠ Hazardous chemicals ⚠

If you are exposed to or come in contact with hazardous chemicals you can be seriously injured. The fluids, lubricants, paints, adhesives, coolant, etc. required for the function of your machine can be hazardous. They may be attractive and harmful to domestic animals as well as humans.

Material Safety Data Sheets (MSDS) provide information about the chemical substances within a product, safe handling and storage procedures, first aid measures, and procedures to take in the event of a spill or accidental release. MSDS are available from your dealer.

Before you service your machine check the MSDS for each lubricant, fluid, etc. used in this machine. This information indicates the associated risks and will help you service the machine safely. Follow the information in the MSDS, and on manufacturer containers, as well as the information in this manual, when you service the machine.

Dispose of all fluids, filters, and containers in an environmentally safe manner according to local laws and regulations. Check with local environmental and recycling centers or your dealer for correct disposal information.

Store fluids and filters in accordance with local laws and regulations. Use only appropriate containers for the storage of chemicals or petrochemical substances.

Keep out of reach of children or other unauthorized persons.

Applied chemicals require additional precautions. Obtain complete information from the manufacturer or distributor of the chemicals before you use them.

Utility safety

Make sure that the machine has sufficient clearance to pass in all directions. Pay special attention to overhead power lines and hanging obstacles. High voltage lines may require significant clearance for safety. Contact local authorities or utilities to obtain safe clearance distances from high voltage power lines.

Retract raised or extended components, if necessary. Remove or lower radio antennas or other accessories. Should a contact between the machine and an electric power source occur, the following precautions must be taken:

- Stop the machine movement immediately.
- Apply the parking brake, stop the engine, and remove the key.
- Check if you can safely leave the cab or your actual position without contact with electrical wires. If not, stay in your position and call for help. If you can leave your position without touching lines, jump clear of the machine to make sure that you do not make contact with the ground and the machine at the same time.
- Do not permit anyone to touch the machine until power has been shut off to the power lines.

Electrical storm safety

Do not operate machine during an electrical storm.

If you are on the ground during an electrical storm, stay away from machinery and equipment. Seek shelter in a permanent, protected structure.

If an electrical storm should strike during operation, remain in the cab. Do not leave the cab or operator's platform. Do not make contact with the ground or objects outside the machine.

Safety rules - Ecology and the environment

Soil, air, and water quality is important for all industries and life in general. When legislation does not yet rule the treatment of some of the substances that advanced technology requires, sound judgment should govern the use and disposal of products of a chemical and petrochemical nature.

Familiarize yourself with the relative legislation applicable to your country, and make sure that you understand this legislation. Where no legislation exists, obtain information from suppliers of oils, filters, batteries, fuels, anti-freeze, cleaning agents, etc., with regard to the effect of these substances on man and nature and how to safely store, use, and dispose of these substances.

Helpful hints

- Avoid the use of cans or other inappropriate pressurized fuel delivery systems to fill tanks. Such delivery systems may cause considerable spillage.
- In general, avoid skin contact with all fuels, oils, acids, solvents, etc. Most of these products contain substances that may be harmful to your health.
- Modern oils contain additives. Do not burn contaminated fuels and or waste oils in ordinary heating systems.
- Avoid spillage when you drain fluids such as used engine coolant mixtures, engine oil, hydraulic fluid, brake fluid, etc. Do not mix drained brake fluids or fuels with lubricants. Store all drained fluids safely until you can dispose of the fluids in a proper way that complies with all local legislation and available resources.
- Do not allow coolant mixtures to get into the soil. Collect and dispose of coolant mixtures properly.
- The air-conditioning system contains gases that should not be released into the atmosphere. Consult an air-conditioning specialist or use a special extractor to recharge the system properly.
- Repair any leaks or defects in the engine cooling system or hydraulic system immediately.
- Do not increase the pressure in a pressurized circuit as this may lead to a component failure.
- Protect hoses during welding. Penetrating weld splatter may burn a hole or weaken hoses, allowing the loss of oils, coolant, etc.

Battery recycling

Batteries and electric accumulators contain several substances that can have a harmful effect on the environment if the batteries are not properly recycled after use. Improper disposal of batteries can contaminate the soil, groundwater, and waterways. CASE IH strongly recommends that you return all used batteries to a CASE IH dealer, who will dispose of the used batteries or recycle the used batteries properly. In some countries, this is a legal requirement.



Mandatory battery recycling

NOTE: *The following requirements are mandatory in Brazil.*

Batteries are made of lead plates and a sulfuric acid solution. Because batteries contain heavy metals such as lead, CONAMA Resolution 401/2008 requires you to return all used batteries to the battery dealer when you replace any batteries. Do not dispose of batteries in your household garbage.

Points of sale are obliged to:

- Accept the return of your used batteries
- Store the returned batteries in a suitable location
- Send the returned batteries to the battery manufacturer for recycling

Torque - Nominal tightening torques for normal assembly

NOTE: In the metric tables, nominal sizes M4 through M8 hardware torque specifications are shown as a Newton meters (pound-inches) numerical value.

Nominal sizes M10 through M24 hardware torque specifications are shown as a Newton meters (pound-feet) numerical value.

Metric hex head (non-flange) hardware

Plain (PLN) – an unplated hardware finish with residual manufacturing oils

Zinc-dichromate (ZND) – a yellow colored chemical plating formula yellow applied to the hardware

Nominal size	Class (CL) 8.8 bolt and Class (CL) 8 nut	Class (CL) 10.9 bolt and Class (CL) 10 nut	Locknut CL 8 w/CL 8.8 bolt	Locknut CL 10 w/CL 10.9 bolt
	PLN and ZND	PLN and ZND	ZND	ZND
	N·m (lb in)	N·m (lb in)	N·m (lb in)	N·m (lb in)
M4	3.5 (31)	5.0 (44)	1.4 (13)	2.8 (25)
M5	7.0 (62)	10 (88)	2.9 (26)	5.5 (49)
M6	11.8 (104)	17 (150)	4.9 (43)	9.4 (83)
M8	28.8 (255)	41.3 (366)	11.9 (105)	23 (204)
	N·m (lb ft)	N·m (lb ft)	N·m (lb ft)	N·m (lb ft)
M10	57 (42)	82 (60)	24 (17)	45 (33)
M12	100 (74)	143 (105)	41 (30)	79 (38)
M14	159 (117)	227 (168)	66 (48)	125 (92)
M16	248 (183)	354 (261)	102 (75)	195 (144)
M18	352 (260)	487 (359)	145 (107)	268 (198)
M20	500 (369)	690 (509)	206 (152)	380 (280)
M24	865 (638)	1195 (882)	357 (263)	657 (485)

Metric flange head hardware

Plain (PLN) – an unplated hardware finish with residual manufacturing oils

Zinc-dichromate (ZND) – a yellow colored chemical plating formula yellow applied to the hardware

Nominal size	Class (CL) 8.8 bolt and Class (CL) 8 nut	Class (CL) 10.9 bolt and Class (CL) 10 nut	Flange locknut CL 8 w/CL 8.8 bolt	Flange locknut CL 10 w/CL 10.9 bolt
	PLN and ZND	PLN and ZND	ZND	ZND
	N·m (lb in)	N·m (lb in)	N·m (lb in)	N·m (lb in)
M4	3.8 (34)	5.5 (49)	4.2 (37)	6.1 (54)
M5	7.7 (68)	11 (97)	8.5 (75)	12 (106)
M6	13 (115)	18.7 (166)	14.3 (127)	20.6 (182)
M8	31.7 (281)	45.5 (403)	35 (310)	50 (443)
	N·m (lb ft)	N·m (lb ft)	N·m (lb ft)	N·m (lb ft)
M10	63 (47)	90 (66)	69 (51)	99 (73)
M12	110 (81)	157 (116)	121 (89)	173 (128)
M14	175 (129)	250 (184)	193 (142)	275 (202)
M16	272 (201)	389 (287)	299 (221)	428 (316)
M18	387 (286)	535 (395)	426 (315)	589 (435)
M20	550 (406)	759 (560)	605 (447)	835 (616)
M24	951 (702)	1315 (970)	1046 (772)	1447 (1067)

Identification markings

Metric hex head, flange hex head and carriage bolts, Classes (CL) 5.6 and upward

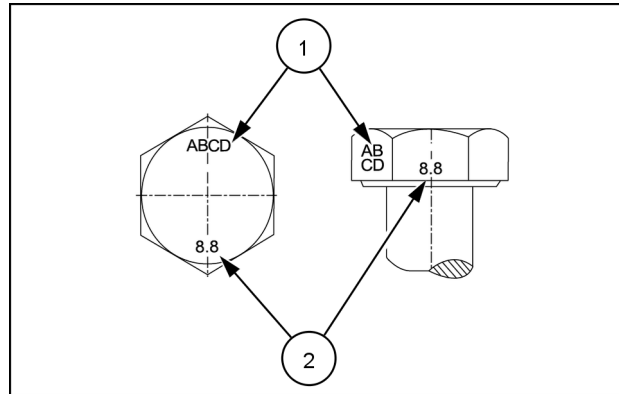

NHIL14RB00662AA 1

Metric bolt identification markings

1. Manufacturer's identification
2. Property class

Metric hex nuts and locknuts, Classes (CL) 05 and upward

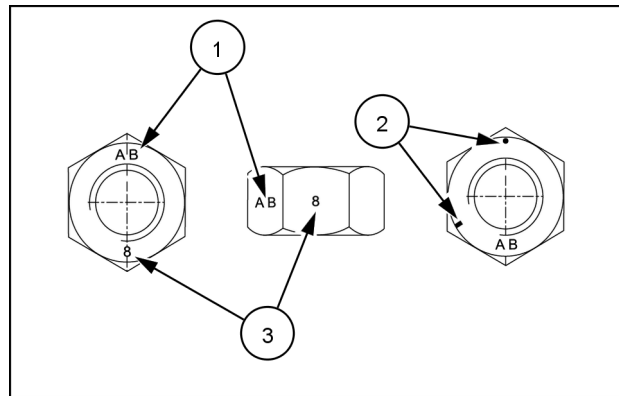

NHIL14RB00663AA 2

Metric hex nut identification markings

- **(1)** – Manufacturer's identification
- **(3)** – Property class
- **(2)** – Clockwise type markings indicate property class and may include manufacturer identification (if applied), Example: property marks **240°** apart (shown) at the eight o'clock position indicate a Class 8 property, and marks **300°** apart at the ten o'clock position indicate a Class 10 property.

NOTE: In the Imperial units tables, the nominal sizes, **1/4 (0.25) in (inch)** and **5/16 (0.3125) in (inch)** hardware torque specifications are shown as a Newton meters (pound-inches) numerical value.
Nominal sizes **3/8 (0.375) in (inch)** through **1 (1.0) in (inch)** hardware torque specifications are shown as a Newton meters (pound-feet) numerical value.

Inch hex head (non-flange) hardware

Plain (PLN) – an unplated hardware finish with residual manufacturing oils

Zinc-dichromate (ZND) – a yellow colored chemical plating formula yellow applied to the hardware

Nominal size	SAE Grade (GR) 5 bolt and nut	SAE Grade (GR) 8 bolt and nut	Locknut GR B w/ GR 5 bolt	Locknut GR C w/ GR 8 bolt
	PLN and ZND	PLN and ZND	ZND	ZND
	N·m (lb in)	N·m (lb in)	N·m (lb in)	N·m (lb in)
1/4 (0.25) in	13 (115)	18 (159)	7.2 (64)	10 (89)
5/16 (0.3125) in	27 (239)	38 (336)	14.9 (132)	21 (186)
	N·m (lb ft)	N·m (lb ft)	N·m (lb ft)	N·m (lb ft)
3/8 (0.375) in	47 (35)	67 (49)	26 (19)	37 (27)
7/16 (0.4375) in	76 (56)	107 (79)	42 (31)	59 (44)
1/2 (0.50) in	116 (85)	164 (121)	64 (47)	90 (67)
9/16 (0.5625) in	167 (123)	236 (174)	92 (68)	130 (96)
5/8 (0.625) in	231 (170)	326 (240)	127 (94)	179 (132)
3/4 (0.75) in	410 (302)	578 (426)	226 (166)	318 (234)
7/8 (0.875) in	660 (486)	931 (687)	363 (267)	512 (378)
1 (1.0) in	989 (729)	1396 (1030)	544 (401)	768 (567)

Inch flange head hardware

Plain (PLN) – an unplated hardware finish with residual manufacturing oils









Zinc-dichromate (ZND) – a yellow colored chemical plating formula yellow applied to the hardware

Nominal size	SAE Grade (GR) 5 bolt and nut	SAE Grade (GR) 8 bolt and nut	Flange locknut GR F w/ GR 5 bolt	Flange locknut GR G w/ GR 8 bolt
	PLN and ZND	PLN and ZND	ZND	ZND
	N·m (lb in)	N·m (lb in)	N·m (lb in)	N·m (lb in)
1/4 (0.25) in	14 (124)	20 (177)	15.4 (136)	22 (195)
5/16 (0.3125) in	29 (257)	42 (372)	32 (283)	46 (407)
	N·m (lb ft)	N·m (lb ft)	N·m (lb ft)	N·m (lb ft)
3/8 (0.375) in	52 (38)	74 (54)	57 (42)	81 (9)
7/16 (0.4375) in	84 (62)	118 (87)	92 (68)	130 (96)
1/2 (0.50) in	127 (94)	180 (133)	140 (103)	198 (146)
9/16 (0.5625) in	184 (136)	259 (191)	202 (150)	285 (210)
5/8 (0.625) in	254 (187)	358 (264)	279 (206)	394 (290)
3/4 (0.75) in	450 (332)	636 (469)	495 (365)	700 (516)
7/8 (0.875) in	725 (535)	1024 (755)	798 (589)	1126 (831)
1 (1.0) in	1088 (802)	1536 (1133)	1197 (882)	1690 (1246)

Identification marking

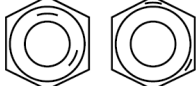
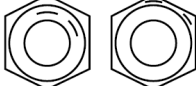
Grades of inch bolts and free-spinning nuts







SAE (J995) bolt head and nut grade identification

Grade identification marking	Grade Marking description
	Grade 2 No line marks
	Grade 5 Three line marks
	Grade 8 Six line marks
	Grade 2 No circumferential line marks
	Grade 5 Two circumferential line marks located 120° apart
	Grade 2 Two circumferential line marks located 60° apart
	Grade 2 No circumferential line marks
	Grade 5 Two circumferential line marks located 120° apart
	Grade 8 Two circumferential line marks located 60° apart

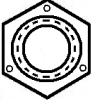
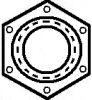
Grades of inch prevailing torque locknuts, all metal (three common marking methods)

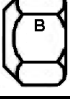
On prevailing torque locknuts, the grade of nut is identified by one of three different sets of markings that denote the strength level and manufacturer.

Common prevailing torque locknut grade identification markings

Grade identification marking	Grade Marking description
	<p>Grade A No marks</p>
	<p>Grade B (hex nut) and Grade F (flange nut) Three raised or indented dot marks (Marks do not have to be in corners.)</p>
	<p>Grade C (hex nut) and Grade F (flange nut) Six raised or indented dot marks (Marks do not have to be in corners.)</p>
	<p>Grade A No letter mark on side flat</p>
	<p>Grade B Letter B on side flat</p>
	<p>Grade C Letter C on side flat</p>
	<p>Grade A No notches</p>
	<p>Grade B One circumferential notch on all six corners</p>
	<p>Grade C Two circumferential notches on all six corners</p>

Basic instructions - Shop and assembly

Shimming

For each adjustment operation, select adjusting shims and measure the adjusting shims individually using a micrometer, then add up the recorded values. Do not rely on measuring the entire shimming set, which may be incorrect, or the rated value shown on each shim.

Rotating shaft seals

For correct rotating shaft seal installation, proceed as follows:

1. Before assembly, allow the seal to soak in the oil it will be sealing for at least thirty minutes.
2. Thoroughly clean the shaft and check that the working surface on the shaft is not damaged.
3. Position the sealing lip facing the fluid.

NOTE: *With hydrodynamic lips, take into consideration the shaft rotation direction and position the grooves so that they will move the fluid towards the inner side of the seal.*

4. Coat the sealing lip with a thin layer of lubricant (use oil rather than grease). Fill the gap between the sealing lip and the dust lip on double lip seals with grease.
5. Insert the seal in its seat and press down using a flat punch or seal installation tool. Do not tap the seal with a hammer or mallet.
6. While you insert the seal, check that the seal is perpendicular to the seat. When the seal settles, make sure that the seal makes contact with the thrust element, if required.
7. To prevent damage to the seal lip on the shaft, position a protective guard during installation operations.

O-ring seals

Lubricate the O-ring seals before you insert them in the seats. This will prevent the O-ring seals from overturning and twisting, which would jeopardize sealing efficiency.

Sealing compounds

Apply a sealing compound on the mating surfaces when specified by the procedure. Before you apply the sealing compound, prepare the surfaces as directed by the product container.

Spare parts

Only use CNH Original Parts or CASE IH Original Parts.

Only genuine spare parts guarantee the same quality, duration, and safety as original parts, as they are the same parts that are assembled during standard production. Only CNH Original Parts or CASE IH Original Parts can offer this guarantee.

When ordering spare parts, always provide the following information:

- Machine model (commercial name) and Product Identification Number (PIN)
- Part number of the ordered part, which can be found in the parts catalog

Protecting the electronic and/or electrical systems during charging and welding

To avoid damage to the electronic and/or electrical systems, always observe the following practices:

1. Never make or break any of the charging circuit connections when the engine is running, including the battery connections.
2. Never short any of the charging components to ground.
3. Always disconnect the ground cable from the battery before arc welding on the machine or on any machine attachment.
 - Position the welder ground clamp as close to the welding area as possible.
 - If you weld in close proximity to a computer module, then you should remove the module from the machine.
 - Never allow welding cables to lie on, near, or across any electrical wiring or electronic component while you weld.
4. Always disconnect the negative cable from the battery when charging the battery in the machine with a battery charger.

NOTICE: *If you must weld on the unit, you must disconnect the battery ground cable from the machine battery. The electronic monitoring system and charging system will be damaged if this is not done.*

5. Remove the battery ground cable. Reconnect the cable when you complete welding.

⚠ WARNING

Battery acid causes burns. Batteries contain sulfuric acid. Avoid contact with skin, eyes or clothing. Antidote (external): Flush with water. Antidote (eyes): flush with water for 15 minutes and seek medical attention immediately. Antidote (internal): Drink large quantities of water or milk. Do not induce vomiting. Seek medical attention immediately. Failure to comply could result in death or serious injury.

W0111A

Special tools

The special tools that CASE IH suggests and illustrate in this manual have been specifically researched and designed for use with CASE IH machines. The special tools are essential for reliable repair operations. The special tools are accurately built and rigorously tested to offer efficient and long-lasting operation.

By using these tools, repair personnel will benefit from:

- Operating in optimal technical conditions
- Obtaining the best results
- Saving time and effort
- Working in safe conditions



Suggest:

For more complete manuals. Please go to the home page.

<https://www.ebooklibonline.com>

If the above button click is invalid. Please download this document first, and then click the above link to download the complete manual.

Thank you so much for reading

General specifications

Model	DC133	DC163
-------	-------	-------

Overall Width		
Transport position	4.04 m (13 ft 4 in)	5.05 m (16 ft 7 in)
Field position – Two-point hitch	6.5 m (21 ft 3 in)	7.8 m (25 ft 7 in)
Field position – Drawbar	6.0 m (19 ft 7 in)	7.3 m (23 ft 11 in)

Overall Length		
Transport position – Two-point hitch	8.4 m (27 ft 5 in)	9.7 m (32 ft 0 in)
Transport position – Drawbar	8.1 m (26 ft 5 in)	9.4 m (31 ft 0 in)
Field position – Two-point hitch	7.0 m (23 ft 0 in)	8.1 m (26 ft 7 in)
Field position – Drawbar	6.7 m (22 ft 0 in)	7.8 m (25 ft 7 in)

Height		
Transport position	2.26 m (7 ft 5 in)	2.26 m (7 ft 5 in)
Field position	2.01 m (6 ft 7 in)	2.01 m (6 ft 7 in)

Ground clearance	
Header fully raised	411 mm (16.2 in)

Weight		
Shipping – Without hitch	2912 kg (6420 lb)	3104 kg (6843 lb)
Shipping – Two-point hitch and drawbar	2991 kg (6594 lb)	3184 kg (7020 lb)
Operating	2846 kg (6274 lb)	3039 kg (6700 lb)

Tractor requirements		
Power	67 kW (90 Hp) or greater with standard Category 2 or Category 3 ASAE/ASABE hitch and PTO locations.	75 kW (100 Hp) or greater with standard Category 2 or Category 3 ASAE/ASABE hitch and PTO locations.
Hydraulic circuits required	Two remote hydraulic circuits capable of 104 bar (1500 psi)	
Electrical	7-pin electrical connector for trailing and road transport lights	
Power Take-Off (PTO) shaft spline and size requirements	21-spline 1-3/8 in	
Input speed	1000 RPM only	
Drive line protection	Overrunning and friction slip clutch assembly at the front of the secondary PTO shaft	

Header		
Flotation	Vertical and radial, adjustable springs	
Windrow width	0.9 - 2.4 m (3.0 - 8.0 ft)	
Swath width – Roll conditioner units	3 m (10 ft)	3.7 m (12.0 ft)
Swath width – Flail conditioner units	3.4 m (11.0 ft)	4.0 m (13.0 ft)
Header lift	Hydraulic (master-slave system)	

Cutterbar		
Type	Modular	
Number of discs	8 counter-rotating	8 counter rotating, 2 co-rotating
Knives per disc	2	
Disc cutting diameter	618 mm (24.3 in)	
Disc drive method	PTO drive with a friction slip clutch to a bevel gearbox at the left-hand end of header, then to a vertical PTO shaft to the cutterbar	
Cutterbar shear protection	Frangible splines in disc drive hub	
Disc speed at 1000 RPM PTO speed	2250 RPM	
Knife tip speed at 1000 RPM PTO speed	261 km/h (162 mph)	
Cutting width	4.0 m (13 ft- 0 in)	4.95 m (16ft-3 in)

INTRODUCTION

Cutterbar	
Cutting height	20 - 69 mm (0.79 - 2.7 in)
Cutting height – High stubble shoes	79 - 140 mm (3.1 - 5.5 in)
Cutting height – Biomass shoes	124 - 198 mm (4.9 - 7.8 in)
Cutting height – Adjustable shoes	20 - 147.0 mm (0.79 - 5.8 in)
Cutterbar angle	-2 ° to -10 °

Conditioner	
Type – Roll conditioner	Chevron intermeshing molded rubber Chevron intermeshing steel rolls
Type – Flail conditioner	Flail rotor with 120 tapered flails
Drive – Roll conditioner	4HB V-shaped belt and enclosed gears
Drive – Flail conditioner	4HB V-shaped belt
Length	3175 mm (125 in)
Diameter – Roll conditioner	2 x 264 mm (10.38 in) rolls
Diameter – Flail conditioner	1 x 560 mm (22 in) flail rotor
Speed – Roll conditioner	Standard 750 RPM (640 RPM optional by swapping sheaves)
Speed – Flail conditioner	Standard 1042 RPM , Optional 752 RPM with the low-speed rotor kit (available from your authorized CASE IH dealer)
Conditioning roll tension adjustment – Roll conditioner	Single crank
Conditioner gap adjustment – Roll conditioner	Draw-bolt stop at each end
Conditioner gap adjustment – Flail conditioner	Single crank adjustment of rotor hood

Miscellaneous specifications	
Operating speed	0 - 14 km/h (0 - 9 mph)
Transport speed	32 km/h (20 mph) maximum
Capacity	3.1 Ha/hr (7.6 Ac/hr) at 10 km/h (6 mph) and 80 % field efficiency.
Tire	12.5L x 15 8PR, Tubeless agricultural rib implement tire
Tire pressure	248 kPa (36 psi)
Jack	2000 lb capacity side-wind
Tongue shift mechanism	Hydraulic

<https://www.ebooklibonline.com>

Hello dear friend!

Thank you very much for reading.

Enter the link into your browser.

The full manual is available for immediate download.

<https://www.ebooklibonline.com>