

2042, 2052 and 2062 Draper Header

Repair Manual

CE

Rac 6-14912

CASE *III*

TABLE OF CONTENTS

GENERAL INFORMATION	9
STANDARD BOLT TORQUE	9
U.S. Standard	9
Metric	10
Metric Torque for Aluminum Components	10
HYDRAULIC FITTINGS	11
Steel Hydraulic Fittings	11
PRODUCT IDENTIFICATION NUMBERS	12
ENVIRONMENT	12
PLASTIC AND RESIN PARTS	12
LEFT DRIVE SHIELD	13
MAXIMUM OPENING FOR RIGHT END DELIVERY	13
LUBRICATION AND MAINTENANCE CHART	14
GENERAL SAFETY INFORMATION	15
Safety Rules	15
Service Area, Fire Extinguisher, First Aid Kit	16
Personal Safety	17
Combine Ballast	18
Transportation Safety	19
Tire Safety	20
Maintenance Safety	21
Driveshaft Safety	22
COMBINE FEEDER SAFETY LOCK	23
REEL SAFETY LOCK	24
Fire or Explosion Prevention	24
TROUBLESHOOTING	25
GENERAL PROCEDURES	41
Taper Lock Hub	41
How It Works	41
Removal and Installation	41
Lock Collar	43
How It Works	43
Removal and Installation	43
Universal Joint	45
How It Works	45
Rebuilding the Universal Joint	45
Guards	49
How It Works	49
Guard Adjustment	50
Regular Guard	50
Stub Guard	50

KNIFE DRIVE SYSTEM	51
Knife Drive System - How It Works	51
Combine Output Shaft Speeds	51
Knife Drive Input Shaft	52
How It Works	52
Bearing Replacement	52
Drive Belt and Idler Tensioner	55
How It Works	55
Removal Alignment and Tensioning	55
Knife Drive Wobble Box	56
How It Works	56
Rebuilding Wobble Box Tools	59
Kit Contents	59
Wobble Box Removal	60
Wobble Box Disassembly	61
Wobble Box Reassembly	67
Wobble Box Installation	79
DRAPER DRIVE SYSTEM	81
Drive System	81
How It Works	81
Combine Adapter Hydraulic Schematics	82
Drapers	84
How It Works	84
Draper Design	84
Installing Drapers	85
Draper Rollers	85
How It Works	85
Hydraulic Draper Motor	85
Draper Drive Assembly	86
Drive Roller Bearing Replacement	87
Idler Roller Bearing Replacement	91
Feed Draper Rollers	94
How It Works	94
Feed Draper Roller Assembly	94
Feed Draper Drive Roller Bearing Replacement	95
Feed Draper Idler Roller Bearing Replacement	98
Draper Tensioning	103
How It Works	103
Draper Tensioning System Repair	104
Feed Draper Deck	106
How It Works	106
Feed Deck Options	106
Widths	106
Feed Draper Deck Removal	107
Prior to Combine Adapter P.I.N. CCC0016651	107
Combine Adapter P.I.N. CCC0016651 and After	111
Retractable Tine Drum (RTD)	114
How It Works	114
Tine Repair	114
Tine Pitch	116
Retractable Tine Drum (RTD) Repair	117
Removing and Repairing the Retracting Tine Drum (RTD)	118
Repositioning the Retracting Tine Drum (RTD)	120

<https://www.ebooklibonline.com>

Hello dear friend!

Thank you very much for reading.

Enter the link into your browser.

The full manual is available for immediate download.

<https://www.ebooklibonline.com>

REEL DRIVE SYSTEM	123
How It Works	123
Reel Drive Hydraulic Schematic	124
Three Arm Reel Lift	124
Reel and Conveyor Drives	125
Reel Drive Motor	126
How It Works	126
Reel Drive Motor Removal	127
Reel Drive Bearing Replacement	129
Reel Bearing Replacement (Tail End)	138
HYDRAULIC SYSTEM	139
How It Works	139
Combine Adapter Schematics	140
Forward Operation - Outer Pump	142
Combine Adapter Schematics - Outer Pump Forward Operation	143
Combine Adapter Schematics - Outer Pump Forward Operation, Over Relief	144
Forward Operation - Inner Pump	145
Combine Adapter Schematics - Inner Pump Forward Operation	146
Combine Adapter Schematics - Inner Pump Forward Operation, Over Relief	147
Reverse Operation	148
Combine Adapter Schematics - Reverse Operation	149
Combine Adapter Schematics - Reverse Operation, Relief	150
Combined Reel Fore/Aft Tilt Valve Block	151
Delta Selector Valve - Reel Fore/Aft	152
Prior to P.I.N. CCC0016651	152
HydraForce Selector Valve	153
P.I.N. CCC0016651 and After	153
HydraForce Selector Valve Schematics	154
AFX Combine	154
2300 Series Combines	155
Hydraulic Testing	156
Minimum Recommended Testing Equipment	156
Required Tools and Parts	156
Checking Relief Valve Setting and Flow Rating	157
RV3 Side Draper - Forward	157
If Relief Pressure Requires Adjustment	158
RV2 Retracting Tine Drum and Feed Draper - Forward	159
If Relief Pressure Requires Adjustment	160
RV1 Retracting Tine Drum and Feed Draper - Reverse	161
If Relief Pressure Requires Adjustment	162
Checking Sequence Valve Operation	163
Testing Hydraulic Flows	164
Testing Pump Output Pressure	165
Prior to Combine Adapter P.I.N. CCC0016044	165
Combine Adapter P.I.N. CCC0016044 and After	166
Hydraulic Oil Specifications	167
Oil Capacity	167
Hydraulic Oil Change Procedure	168
Hydraulic Oil Filter Change	169
Reel Lift Cylinders	170
Reel Lift Theory	170
Diagnostic Tests - Static	171
Diagnostic Tests - Dynamic	172
Static and Dynamic Test Diagnostic Chart	173
Problems and Solutions	173

Master Reel Lift Cylinder 174
 Prior to 2042 P.I.N. CCC0013130; Prior to 2052 P.I.N. CCC0014385 and
 Prior to 2062 P.I.N. CCC0015138 174
 2042 P.I.N. CCC0013130 and After; 2052 P.I.N. CCC0014385 and After;
 and 2062 P.I.N. CCC0015138 and After 175
 Center Master Reel Lift Cylinder 176
 Reel Lift Slave Cylinder Repair 177
 Disassembly 177
 Inspection 177
 Reassembly 177
 Fore/Aft Cylinder 178
 Hydraulic Motors 179
 Hydraulic Motor Repair 180
 Disassembly 180
 Gerotor End 180
 Follow the Reassembly Instructions 182
 Reassembly Procedure 183
 Shaft End 183
 Gerotor End 187
 Timing Procedure 187
 Hydraulic Motor - Retracting Tine Drum 188
 Disassembly 188
 Repair Motor 193
 Reassembly 193
 Hydraulic Motor - Feed Draper 198
 Repair Motor 198
 Repair Motor 203
 Assembly 204
 Gearbox and Pump 209
 How It Works 209
 Pump Repair 210
 Disassembly 210
 Repair 214
 Seal Repair 214
 Reassembly 216
 Gearbox Repair 219
 Disassembly 219
 Reassembly 222
 Valve Block 225
 How It Works 225
 Multi-Link - AFX Combine 227
 How It Works 227

ELECTRICAL SYSTEM	229
Lighting	229
How It Works	229
Electrical Schematic	230
Prior to 2042 P.I.N. CCC0013130; Prior to 2052 P.I.N. CCC0014385; Prior to 2062 P.I.N. CCC0015138	230
2042 P.I.N. CCC0013130 and After; 2052 P.I.N. CCC0014385; and After; 2062 P.I.N. CCC0015138 and After	230
Transport Option Electrical System	231
How It Works	231
Electrical Schematic	231
Normal Driving Mode	233
Turning Mode	233
Selector Valve	235
Prior to Header 2042 P.I.N. CCC0013130; Prior to 2052 P.I.N. CCC0014385; Prior to 2062 P.I.N. CCC0015138	235
Prior to Combine Adapter P.I.N. CCC0016651	235
How It Works	235
Hydraulic Schematic	235
Header 2042 P.I.N. CCC0013130 and After; 2052 P.I.N. CCC0014385 and After; 2062 P.I.N. CCC0015138 and After	241
Combine Adapter P.I.N. CCC0016651 and After	241
How It Works	241
Electrical/Hydraulic Schematic	241
Delta Coil Resistance	241
Hydraforce Coil Resistance	241
2300 Series Combine Electrical Setup for the Selector Valve	242
AFX Combine Electrical Setup for the Selector Valve	245
Float Optimizer	249
How It Works	249
Adjustment and Operation	253
Troubleshooting	254
Adjusting the Sensor Range	255
Check the Sensor Voltage Output	255
To Adjust High Voltage Limit	255
To Adjust Low Voltage Limit:	255
Potentiometer Troubleshoot	256
Diagnostic of Potentiometer	256
Test Procedure	256

LINKAGE AND SUSPENSION	257
Header and Combine Adapter	257
How It Works	257
Suspension Assembly	258
How It Works	258
Adapter Suspension Repair	259
Disconnecting Adapter from Header	259
Coil Springs	263
How It Works	263
Coil Spring Replacement	264
Lower Pivot Arm Bearings	268
How It Works	268
Bearing Replacement	268
Header Flotation	271
Adjusting the Float	271
To Increase Float	271
To Decrease Float	271
Vertical Wing Adjustment and Flotation Check Block Test) - Flex Header	272
Adjust Left Wing	274
Adjust Right Wing	274
Block Test Analysis	276
Wing Flex Range	277
Fore/Aft Straightness and Vertical Alignment of the Wing Frames	278
How It Works	278
Fore/Aft Adjustment	278
Vertical Adjustment	280
Cutter Bar Straightness - 2062 Header	281
Flex Range Adjustment	282
STRUCTURE	285
Impact Repairs	285
How It Works	285
Cutter Bar Stringing	285
Impact Repair Parts	286
HEADER WING REMOVAL	287
Reel Removal	287
Right Reel Removal	287
Left Reel Removal	288
Wing Removal	290
Wing Disassembly	290
Sickle (Cutter Bar) Removal	290
Right Wing Removal	291
Left Wing Removal	295
Support Bar Removal on Cutter Bar (Either Wing)	299
Supporting the Wings for Removal	300
How to Support Both Wings	300
Combine Adapter Removal	301
Disconnecting Header from Combine and Combine Adapter	301
Disconnecting Wing	305
Connecting the Wing	307
Installing Left Wing	312
Installing Right Wing	314
Attaching Combine Adapter	316
Attaching Header to Combine and Combine Adapter	316
Bell Crank Removal	322
Removing the Bell Crank	322
Installing the Bell Crank	325

FLOAT OPTIMIZER	329
Adjustment and Operation	329
Troubleshooting	330
Combine Calibration	331
2100 and 2300 Series Combine Configuration	331
Operation	332
Automatic Header Height Control	332
(If Equipped)	332
Diagnostic of Potentiometer	333
Test Procedure	333
AFX Combine Configuration	334
Automatic Header Height	334
Auto Height Mode	334
Header Calibration	336
Header Height Calibration	336
Ground Calibration	337
Raise and Lower Sensitivity	338
Manual Header Height Control	338
Height and Tilt Sensitivity	338
Setting the Working Setting and Operating Mode	339
Header Controls	340
Reel Position Switch	340
Diagnostic of Potentiometer	340
Test Procedure	340

NOTE: Throughout this manual you will see a  symbol. The information supplied after the symbol offers suggestions to help you with the operation and maintenance of the machine.

GENERAL INFORMATION

This Service Manual contains important information about the adjustment, how it works and repairing your Draper Header. Refer to the **Table of Contents** at the beginning of this manual for locating specific items about your machine.

This Service Manual should be used in conjunction with the Draper Header Operator's Manual.

The Left and Right side of the Draper Header are the same as your Left and Right hand while seated in the Combine Operator's Seat facing forward.

NOTE: Throughout this manual you will see a  symbol. The information supplied after the symbol offers suggestions to help you with the operation and maintenance of the machine.

STANDARD BOLT TORQUE

NOTE: The tables below give correct torque values for various bolt sizes. Tighten all bolts specified in the tables unless otherwise noted.

U.S. Standard

Grade 5 Bolts, Nuts, and Studs		
		
Size	Pound-Inches	Newton metres
1/4 inch	108 to 132	12 to 15
5/16 inch	204 to 252	23 to 28
3/8 inch	420 to 504	48 to 57
Size	Pound-Feet	Newton metres
7/16 inch	54 to 64	73 to 87
1/2 inch	80 to 96	109 to 130
9/16 inch	110 to 132	149 to 179
5/8 inch	150 to 180	203 to 244
3/4 inch	270 to 324	366 to 439
7/8 inch	400 to 480	542 to 651
1.0 inch	580 to 696	787 to 944
1-1/8 inch	800 to 880	1085 to 1193
1-1/4 inch	1120 to 1240	1519 to 1681
1-3/8 inch	1460 to 1680	1980 to 2278
1-1/2 inch	1940 to 2200	2631 to 2983

Grade 8 Bolts, Nuts, and Studs		
		
Size	Pound-Inches	Newton metres
1/4 inch	144 to 180	16 to 20
5/16 inch	288 to 348	33 to 39
3/8 inch	540 to 648	61 to 73
Size	Pound-Feet	Newton metres
7/16 inch	70 to 84	95 to 114
1/2 inch	110 to 132	149 to 179
9/16 inch	160 to 192	217 to 260
5/8 inch	220 to 264	298 to 358
3/4 inch	380 to 456	515 to 618
7/8 inch	600 to 720	814 to 976
1.0 inch	900 to 1080	1220 to 1465
1-1/8 inch	1280 to 1440	1736 to 1953
1-1/4 inch	1820 to 2000	2468 to 2712
1-3/8 inch	2380 to 2720	3227 to 3688
1-1/2 inch	3160 to 3560	4285 to 4827

NOTE: Use thick nuts with Grade 8 bolts.

Metric

Grade 8.8 Bolts, Nuts, and Studs		
		
Size	Pound-Inches	Newton metres
M4	24 to 36	3 to 4
M5	60 to 72	7 to 8
M6	96 to 108	11 to 12
M8	228 to 276	26 to 31
M10	456 to 540	52 to 61
Size	Pound-Foot	Newton metres
M12	66 to 79	90 to 107
M14	106 to 127	144 to 172
M16	160 to 200	217 to 271
M20	320 to 380	434 to 515
M24	500 to 600	675 to 815
M30	920 to 1100	1250 to 1500
M36	1600 to 1950	2175 to 2600

Grade 10.9 Bolts, Nuts, and Studs		
		
Size	Pound-Inches	Newton metres
M4	36 to 48	4 to 5
M5	84 to 96	9 to 11
M6	132 to 156	15 to 18
M8	324 to 384	37 to 43
Size	Pound-Foot	Newton metres
M10	54 to 64	73 to 87
M12	93 to 112	125 to 150
M14	149 to 179	200 to 245
M16	230 to 280	310 to 380
M20	450 to 540	610 to 730
M24	780 to 940	1050 to 1275
M30	1470 to 1770	2000 to 2400
M36	2580 to 3090	3500 to 4200

Metric Torque for Aluminum Components

Bolt Diameter	Grade 8.8		Grade 10.9	
	Nm	lb-ft	Nm	lb-ft
M3				1
M4			4	2.6
M5			8	5.5
M6	9	6	12	9
M8	20	14	28	20
M10	40	28	55	40
M12	70	52	100	73

HYDRAULIC FITTINGS

Tube OD Hose ID	Thread Size	Pound- Inches	Newton metres
37 Degree Flare Fitting			
1/4 inch 6.4 mm	7/16-20	72 to 144	8 to 16
5/16 inch 7.9 mm	1/2-20	96 to 192	11 to 22
3/8 inch 9.5 mm	9/16-18	120 to 300	14 to 34
1/2 inch 12.7 mm	3/4-16	180 to 504	20 to 57
5/8 inch 15.9 mm	7/8-14	300 to 696	34 to 79
Tube OD Hose ID	Thread Size	Pound- Foot	Newton metres
3/4 inch 19.0 mm	1-1/16-12	77 to 82	104 to 111
7/8 inch 22.2 mm	1-3/16-12	90 to 100	122 to 136
1.0 inch 25.4 mm	1-5/16-12	110 to 120	149 to 163
1-1/4 inch 31.8 mm	1-5/8-12	140 to 150	190 to 204
1-1/2 inch 38.1 mm	1-7/8-12	225 to 240	305 to 325

Tube OD Hose ID	Thread Size	Pound- Inches	Newton metres
Straight Threads with O-ring			
1/4 inch 6.4 mm	7/16-20	144 to 228	16 to 26
5/16 inch 7.9 mm	1/2-20	192 to 300	22 to 34
3/8 inch 9.5 mm	9/16-18	300 to 480	34 to 54
1/2 inch 12.7 mm	3/4-16	540 to 804	57 to 91
Tube OD Hose ID	Thread Size	Pound- Foot	Newton metres
5/8 inch 15.9 mm	7/8-14	58 to 92	79 to 124
3/4 inch 19.0 mm	1-1/16-12	80 to 128	108 to 174
7/8 inch 22.2 mm	1-3/16-12	100 to 160	136 to 216
1.0 inch 25.4 mm	1-5/16-12	117 to 187	159 to 253
1-1/4 inch 31.8 mm	1-5/8-12	165 to 264	224 to 357
1-1/2 inch 38.1 mm	1-7/8-12	250 to 400	339 to 542

Steel Hydraulic Fittings

Nom. SAE Dash Size	Tube OD	Thread Size	Pound- Inches	Newton metres	Thread Size	Pound- Inches	Newton metres
O-ring Face Seal End					O-ring Boss End Fitting or Lock Nut		
-4	1/4 inch 6.4 mm	9/16-18	120 to 144	14 to 16	7/16-20	204 to 240	23 to 27
-6	3/8 inch 9.5 mm	11/16-16	216 to 240	24 to 27	9/16-18	300 to 360	34 to 41
-8	1/2 inch 12.7 mm	13/16-16	384 to 480	43 to 54	3/4-16	540 to 600	61 to 68
					Thread Size	Pound- Foot	Newton metres
-10	5/8 inch 15.9 mm	1-14	552 to 672	62 to 76	7/8-14	35 to 40	47 to 54

Nom. SAE Dash Size	Tube OD	Thread Size	Pound-Feet	Newton metres	1-1/16-12	60 to 70	81 to 95
					1-3/16-12	70 to 80	95 to 109
-12	3/4 inch 19.0 mm	1-3/16-12	65 to 70	90 to 95	1-5/16-12	80 to 90	108 to 122
-14	7/8 inch 22.2 mm	1-3/16-12	65 to 70	90 to 95	1-5/8-12	95 to 115	129 to 156
-16	1.0 inch 25.4 mm	1-7/16-12	92 to 100	125 to 135	1-7/8-12	120 to 140	163 to 190
-20	1-1/4 inch 31.8 mm	1-11/16-12	125 to 140	170 to 190			
-24	1-1/2 inch 38.1 mm	2-12	150 to 165	200 to 225			

PRODUCT IDENTIFICATION NUMBERS

When ordering parts or when requesting information or assistance always give the following information:

1. Machine Name
2. Model Number
3. Product Identification Number (P.I.N.)

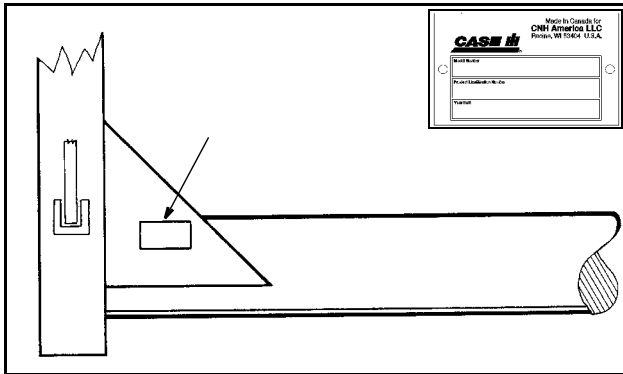

RH99A102 / RH04D002

HEADER P.I.N. PLATE - LEFT SIDE GUSSET NEAR MAIN TUBE

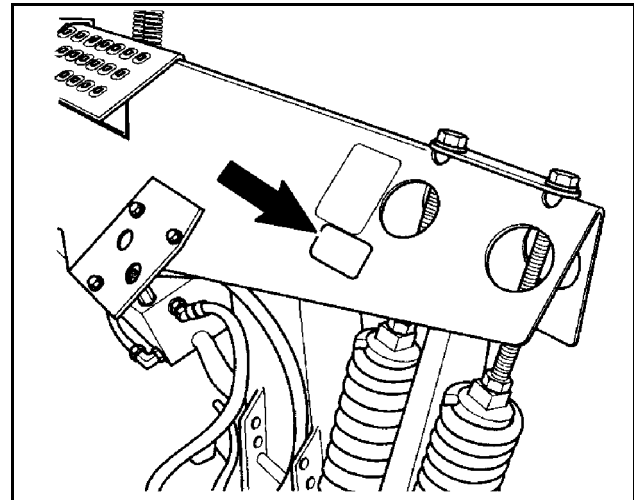

RH03G026

COMBINE ADAPTER P.I.N. PLATE - LEFT SIDE OF ADAPTER FRAME

ENVIRONMENT

Before you service this machine and before you dispose of the old fluids and lubricants, always remember the environment. DO NOT put oil or fluids into the ground or into containers that leak.

Check with your local environmental or recycling center or your dealer for correct disposal information.

PLASTIC AND RESIN PARTS

Avoid using gasoline, kerosene, paint thinner, etc., when cleaning plastic or resin parts. Use ONLY water, mild soap and a soft cloth when you clean these parts.

Using gasoline, kerosene, thinners, etc., will cause decolorization, cracking or deformation of the part being cleaned.

LEFT DRIVE SHIELD

Some Headers may be equipped with special tool operated latches.

These tool operated latches are used to lock and unlock the end shields and guards.

To unlock the latch use a flat blade screwdriver. Insert screwdriver blade into latch and pivot the screwdriver to release the latch, as shown in the illustration.

NOTE: *The Left drive shield, in the open position, rests on bracket (1) to prevent it from falling.*

To open drive shield - Pull catch handle (2).

To close drive shield - Push bracket (1) to free the welded bolt to travel in bracket slot. Lower shield and secure in Field Operation position.

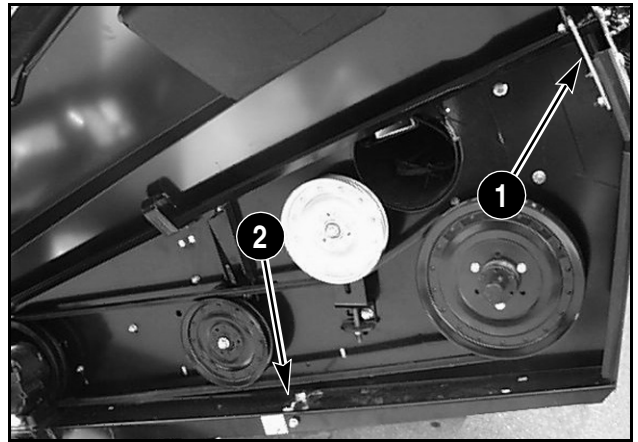

RR02H098

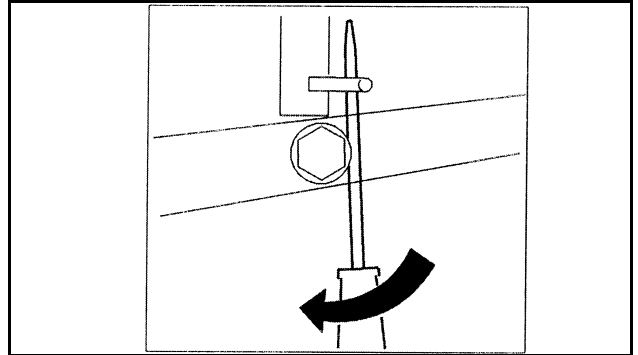

348636A

MAXIMUM OPENING FOR RIGHT END DELIVERY

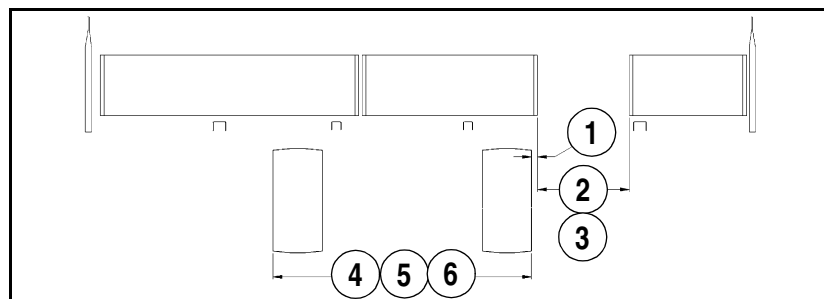

RH03J001

- | | |
|--|--|
| 1. 50 mm (2 INCH) | 4. MAX. COMBINE WIDTH FOR RIGHT OF CENTER DELIVERY |
| 2. WIDE FEEDER HOUSING - 1372-1640 mm (54-64.5 INCH) | 5. WIDE FEEDER HOUSING - 4400 mm (173 INCH) |
| 3. NARROW FEEDER HOUSING - 1037-1182 mm (40.8-46.5 INCH) | 6. NARROW FEEDER HOUSING - 5150 mm (203 INCH) |

LUBRICATION AND MAINTENANCE CHART

SERVICE POINTS	FREQUENCY IN HOURS				REPLACE
	NO. OF POINTS	GREASE	CHECK	CHANGE	
Secondary Drive Shaft	3	10			
Sickle Cutter Bar (See Note 1)	1	10			
Check Hydraulic Hoses and Lines for Leaks			10		
Hydraulic Oil Level	1		25		
Sickle Head	1	25			
Tire Pressure			50		
Reel Support Bushings (30 and 36 foot Pickup Reel)	1	50			
Reel Drive Support Bearing	1	100			
Reel Tail Support Bearing	1	100			
Reel Drive Support Cam	1	100			
Sickle Drive Shaft Support Bearings	2	100			
Gauge Wheel Pivot Bushing	2	100			
Upper Cross Auger Bearing (If equipped)	1	100			
Retracting Tine Drum Bearing (If equipped)	1	100			
Feed Draper Idler Roller Bearing - Combine Adapter	2	100			
Feeder Draper Drive Roller Bearing - Combine Adapter	1	100			
Wobble Box Mounting Bolts	4		100		
Gauge Wheel Bolt Torque	6		100		
Transport Wheel Support Pivot	4	100			
Split Reel Connector Block	1	100			
Draper Roller Bearing	6	100			
Combine Adapter Drum Bearing	1	100			
Lower Link Pins	2	10			
Hydraulic Oil Filter				250	
Gauge Wheel Hub Bearing (Per Wheel)	1	500			
Transport Wheel Hub Bearing		500			
Draper Drive Roller Bearings	4				500
Reel Drive Chain	1	*			
Hydraulic Oil Change (See Note 3)				1000	
Hydraulic Gearbox (See Note 2)				1000	
Wobble Box (See Note 2)	1		100	1000	

NOTE 1: USE SAE 10W ENGINE OIL

NOTE 2: USE SAE 85W-140

GEAR LUBRICANT - Change after first 50 hours of operation

NOTE 3: USE HYDRAULIC OIL

* ANNUALLY

Use NLGI Number 2 Multi Purpose Lithium EP Grease.

GENERAL SAFETY INFORMATION

Understand that your safety and the safety of other persons is measured by how you service and operate this machine. Know the positions and operations of all controls before you try to operate. **MAKE SURE YOU CHECK ALL CONTROLS IN A SAFE AREA BEFORE STARTING YOUR WORK.**

Make sure you understand all the controls of the machine. Refer to Operator's Manual. All equipment has a limit.

CNH America LLC is continuing to work for your safety: by making machines with better protection and by giving these rules for safe operation and servicing the machine.



*THIS SAFETY ALERT SYMBOL INDICATES IMPORTANT SAFETY MESSAGES IN THIS MANUAL. WHEN YOU SEE THIS SYMBOL, CAREFULLY READ THE MESSAGE THAT FOLLOWS AND BE ALERT TO THE POSSIBILITY OF DEATH OR SERIOUS INJURY.*M171C

Safety Rules

- Always shut OFF engine, remove the key and engage feeder safety lock in position on lift cylinder before working under Header or feeder. Failure to engage feeder safety lock may cause injury or death. M184D
- Never connect the reel fore/aft hydraulic couplers on the Header to each other. This would complete the circuit and allow the reel to slide unexpectedly. M209B
- Never make adjustments when Header or machine is running. R208B
- Never operate the machine with shields removed. M423
- ALWAYS make sure working area is clear of other persons before you start operating this machine. NEVER allow anybody in work area during machine operation or servicing.
- Always wear safety glasses when using a drill, hammer, saw, or other tools that may cause chips to fly. M428
- Replace all covers or guards after servicing or cleaning the machine. NEVER operate the machine with covers or guards removed. Serious injury or death can result. CM115A
- Do Not modify the machine. Unauthorized modifications may cause operational malfunction or safety hazard.
- ALWAYS make sure working area is clear of other persons, pets, tools, etc. before you start operating this machine. NEVER allow anybody in work area during machine operation.
- ALWAYS sound horn before starting the Combine.
- Keep service area clean and dry. Wet or oily floors are slippery. Wet areas can be dangerous when working with electrical equipment. Be sure all electrical outlets and tools are properly grounded.
- ALWAYS disconnect the battery (both terminals) before welding on any part of the machine. Failure to do so may cause damage to sensitive electrical components. M866
- Keep work areas organized and clean. Wipe up oil or spills of any kind. Keep tools and parts off of the floor. Eliminate the possibility of a fall which could result in a serious injury. M429
- After installation or servicing, make sure all tools and any equipment used during installation or service are removed from the machine. M430A

- Before leaving the machine, stop the engine, place all controls in neutral, engage the parking brake and remove the key. M581A

- A frequent cause of personal injury or death is persons falling off and being run over. Do not permit anyone to ride on the machine. M265A

- Hydraulic oil or diesel fuel leaking under pressure can penetrate the skin and cause infection or other injury.

To Prevent Personal Injury:

Relieve all pressure, before disconnecting fluid lines or performing work on the hydraulic system.

Before applying pressure, make sure all connections are tight and components are in good condition.

Never use your hand to check for suspected leaks under pressure.

Use a piece of cardboard or wood for this purpose.

If injured by leaking fluid, see your doctor immediately. M149C

- Always make sure to stay clear of drive shaft until all movement has stopped and Combine engine has stopped and key is removed from key switch. Entanglement with rotating drive shaft will cause serious injury or death. Always wear proper fitting clothing when working around machine.

- Handle cutter bar very carefully. Always wear heavy gloves when working around the cutter bar or handling sharp knives. Keep other body parts away from cutter bar.

- ALWAYS turn OFF Combine engine and remove the key before servicing the Header. Never under any conditions lubricate the Header while machine is running. M207C

- ALWAYS wear gloves when handling the hydraulic pump.

Service Area, Fire Extinguisher, First Aid Kit

Keep the area used for servicing the machine clean and dry. Wet or oily floors are slippery. Wet spots can be dangerous when working with electrical equipment. Be sure all electrical outlets and tools are properly grounded.

It is recommended that you have a Fire Extinguisher and a First Aid Kit in your maintenance area.



RH01N064

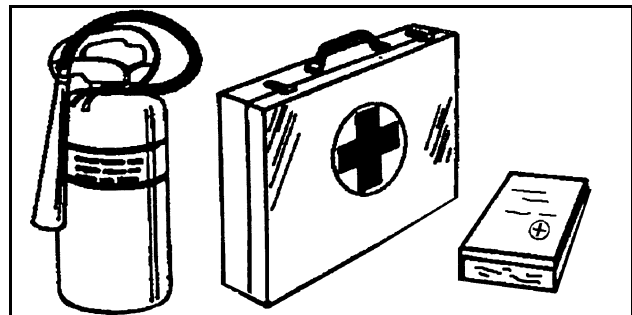

RH99E028

Personal Safety





RH02F040

Throughout this manual and on the machine's safety decals, you will find precautionary statements: **DANGER**, **WARNING** or **CAUTION** followed by specific instructions or ISO two panel safety pictorial symbols. These precautions are intended for your personal safety.

Failure to follow the **DANGER**, **WARNING** or **CAUTION** instructions may result in death or serious bodily injury.

DANGER, **WARNING** or **CAUTION** are defined as follows:

- **DANGER:** Indicates an immediate hazardous situation that, if not avoided, will result in death or serious injury. The color associated with Danger is RED.
- **WARNING:** Indicates a potentially hazardous situation that, if not avoided, could result in death or serious injury. The color associated with Warning is ORANGE.
- **CAUTION:** Indicates a potentially hazardous situation that, if not avoided, may result in minor or moderate injury. It may also be used to alert against unsafe practices. The color associated with Caution is YELLOW.
- ISO two panel **pictorial symbol decals** are defined as follows:
 - The first panel indicates the nature of the hazard.
 - The second panel indicates the appropriate avoidance of the hazard.
 - Background color is YELLOW.
 - Prohibition symbols such as   and  if used, are RED.

Combine Ballast

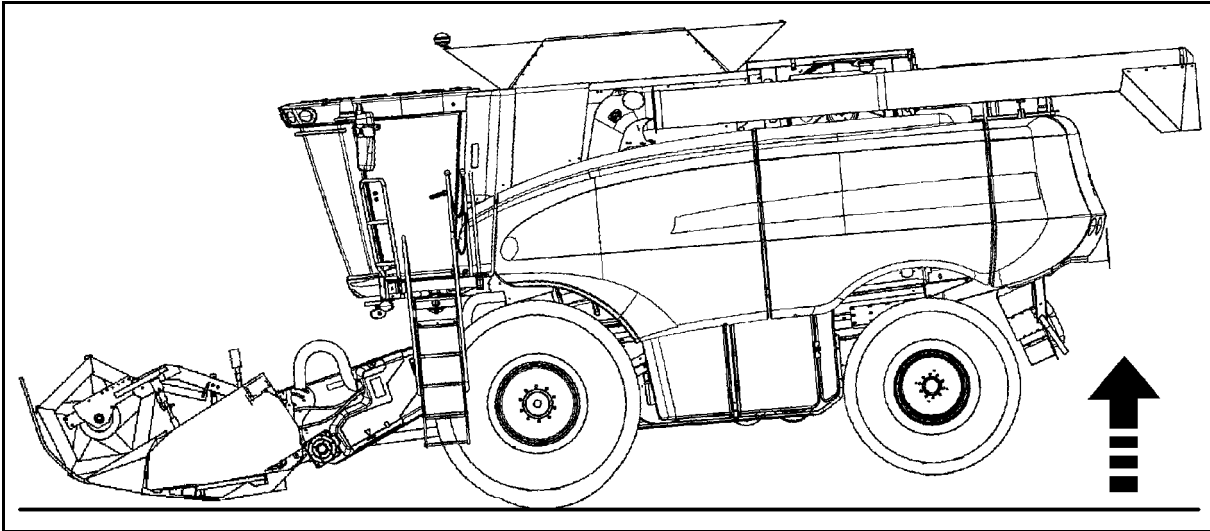

RH03G069

Make sure your Combine has proper ballasting. Large and/or heavy Headers may alter the center of gravity of your machine. This will affect your operating, steering and braking performance.

Refer to your Combine Operator's Manual for the correct ballast required for your application.

ATTENTION: 2300 Series Combines: 2388 - 12 Row Ready Combine is the only 2300 Series Combine authorized for use with the 36 foot Header.

ATTENTION: AFX Combine is the only Combine authorized for use with the 39 foot Header.



Suggest:

For more complete manuals. Please go to the home page.

<https://www.ebooklibonline.com>

If the above button click is invalid. Please download this document first, and then click the above link to download the complete manual.

Thank you so much for reading

Transportation Safety

- DO NOT drive Combine with Header attached on a road or highway at night or in conditions which reduce visibility such as fog or rain. The width of the Header may not be visible under these conditions.
- Check local laws for width regulations and lighting or marking requirements before transporting on roads.
- Make sure all warning, tail and head lamps are clean and in proper working order. Always use these lamps on roads to provide adequate warning to other vehicles.
- Connect hitch to towing vehicle with a proper hitch pin.
- Attach hitch safety chain to towing vehicle.
- Connect Header wiring harness to mating connector on towing vehicle.
- Do not tow Header with a vehicle weighing less than 2300 kg (5000 pounds).
- Before driving Combine on a road, be sure all warning lamps are clean and working properly.
- Lower reel completely. Make sure reel is completely back and on support arms.
- When travelling down hill, reduce speed and keep Header at a minimum height for maximum stability. Raise Header at bottom of grade to avoid contacting the ground.
- Header stability is reduced when turning corners. Turn corners only at very low speeds [8 km/h (5 m.p.h.) or less].
- Travel speed should be such that complete control and machine stability are maintained at all times. Do Not exceed 30 km/h (20 m.p.h.) when transporting.
- Drive SLOWLY - travel speed should be such that complete control and machine stability are maintained at all times.
- Never connect the fore/aft couplers to each other. This would complete the circuit and allow the reel to creep forward during transport, resulting in instability.
- Make sure all pins are properly secured in transport position at wheel supports, hitch and cutter bar support.
- On narrow or hilly roads or blind curves - where motor vehicles can suddenly come upon slow moving traffic, extra caution should be exercised, such as having two vehicles proceed/follow the Combine to warn and/or removing the Header and transport separately.

NOTE: *If transporting the Header in field position on a flat bed trailer, take care when positioning tie down straps to avoid damage to safety decals and reflectors on main tube.*

⚠ Tire Safety ⚠

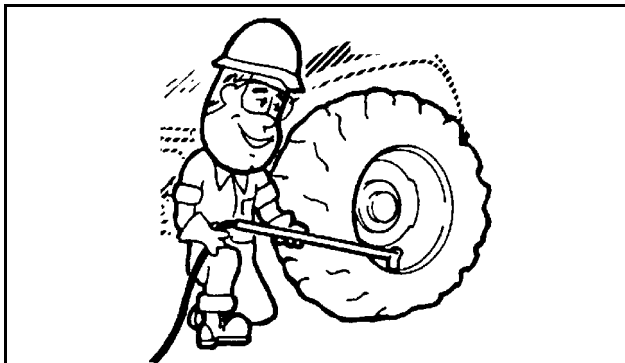

RH02F038

- Use a clip on air chuck, extension hose with gauge and stand away from the tire while inflating to prevent the possibility of personal injury due to a tire and rim separation, etc.
- Do not remove, install or make repairs to a tire on a rim. If required, the tire and wheel rim should be removed from the machine by a qualified field tire technician with the proper equipment. If required, the field technician should take the tire and wheel rim to a tire shop where persons with special training and special safety tools are available. If the tire is not in correct position on the rim, or if too full of air, the tire bead can loosen on one side and cause air to leak at high speed and with large force. Because the air leak can thrust the tire in any direction, and with much force, you will be in danger of injury. M169C



RH02F039

- Explosive separation of the tire and/or rim parts can cause injury or death. When tire service is necessary, have a qualified tire technician service the tires.
- DO NOT weld to wheel or rim until the tire is completely removed. Inflated tires can generate a gas mixture with the air that can be ignited by high temperatures from welding procedures performed on the wheel or rim. This condition can exist whether tires are inflated or deflated. Removing the air or loosening the tire on the rim (breaking the bead) will NOT eliminate the hazard. The tire MUST be completely removed from the wheel or rim prior to welding the wheel or rim. SC134
- A tire can explode during inflation and cause serious injury or death. Never increase air pressure beyond 35 PSI (2.4 bar) to seat the bead on the rim. Replace a tire if it has a defect. Replace a wheel rim which has cracks, wear or severe rust. Make sure that all the air is removed from a tire before removing the tire from the rim. Never use force on an inflated or partially inflated tire. Make sure the tire is correctly seated before inflating.

<https://www.ebooklibonline.com>

Hello dear friend!

Thank you very much for reading.

Enter the link into your browser.

The full manual is available for immediate download.

<https://www.ebooklibonline.com>