

MF 2430 - 2435 - 2440

**WORKSHOP MANUAL
P/N 3681774M1 - EDITION 01-2006**



MASSEY FERGUSON



TABLE OF CONTENTS

	Section N°	Edition
1 GENERAL INFORMATION		
General information	100	01-2006
2 ENGINE		
Engine	200	01-2006
3 CLUTCH		
Clutch	300	01-2006
4 GEARBOX		
Speedfive and Powerfive mechanical gearbox	400	01-2006
5 TRANSMISSION		
Rear axle and side final drives	500	01-2006
Front axle	510	01-2006
6 POWER TAKE-OFF		
Power take-off	600	01-2006
7 HYDRAULIC SYSTEMS		
Hydraulic systems - Rear power lift.	700	01-2006
8 STEERING		
Steering	800	01-2006
9 BRAKES		
Brakes	900	01-2006
10 ELECTRICAL SYSTEMS		
Electrical system - Instruments	1000	01-2006
Electrical system - Components	1010	01-2006
Electrical system – Ignition system	1020	01-2006
Electrical system – Recharging system	1030	01-2006
Electrical system - Battery	1040	01-2006
Electrical system – Electrical circuits	1050	01-2006
11 CAB		
Cab and A/C system	1100	01-2006



<https://www.ebooklibonline.com>

Hello dear friend!

Thank you very much for reading.

Enter the link into your browser.

The full manual is available for immediate download.

<https://www.ebooklibonline.com>

SECTION 100

GENERAL INFORMATION



TABLE OF CONTENTS

Description	Page
SAFETY NOTES	100-3
Personal risk	100-3
Avoid accidents	100-3
General rules	100-3
Starting	100-5
Engine	100-5
Electrical systems	100-5
Hydraulic circuits	100-5
Wheels and tyres	100-6
Unhitching and re-hitching	100-6
GENERAL INSTRUCTIONS	100-7
Battery	100-7
Adjuster shims	100-7
Spinning shaft seals	100-7
O-ring toroid seals	100-7
Bearings	100-7
Spring pins	100-7
Notes about spare parts	100-8
SPECIFIC EQUIPMENT	100-8
SYMBOLS	100-9
Meaning and use	100-9
DANGER SIGNS	100-11
Positions of the danger decals - WEO markets	100-11
SEALING AND FIXING SEALANTS	100-16
LUBRICANTS AND FUELS	100-17
CONVENTIONAL UNITS OF MEASUREMENT	100-18
Units of measurement (international system)	100-18
Conversion values for Imperial measurement system	100-18
STANDARD DRIVING TORQUE VALUES	100-19
Screws with metric threads	100-19
Nuts with metric threads	100-20



SAFETY NOTES

Personal risk

This warning symbol draws your attention to messages that are important for your safety.

Read the safety notes carefully and comply with the recommended precautions to avoid potential dangers and safeguard your health and personal safety.

This symbol appears in the text along with the following key words:

WARNING - To warn of unsuitable repair operations with potential consequences that could affect the repair technician's safety.

DANGER - To indicate warnings that specifically denote potential dangers for the operator's safety or for other directly or indirectly involved persons.



1

Avoid accidents

The majority of accidents that occur in workshops are caused by failure to comply with some simple and fundamental rule of caution and safety. Therefore IN MOST CASES THEY CAN BE AVOIDED: all that's needed is to foresee the possible causes and consequently act with due care and caution.

However well a machine is designed and built, it is never possible to absolutely exclude all hazardous situations.

A careful and prudent mechanic is the best guarantee against accidents.

Strict compliance with even only one elementary safety rule would be sufficient to avoid many serious accidents.

DANGER. Never carry out any cleaning, lubricating or servicing operations whilst the engine is running.

General rules

- Carefully comply with the prescribed maintenance and repair procedures.
- Do not wear rings, watches, jewellery, unfastened or hanging garments, such as ties, torn clothing, scarves, unbuttoned jackets or with open zip-fasteners that could become caught in moving parts. You are advised to wear approved safety garments, such as: non-slip footwear, gloves, safety goggles, helmets, etc.
- Never carry out repair work on the machine whilst someone is sitting in the driver's seat, unless this person is an authorized operator who is helping with the operations in progress.
- Only operate the machine and use the relative implements when you are sitting in the driver's seat.
- Do not carry out any work on the machine when the engine is running, unless this is specifically prescribed.
- Stop the engine and make sure that the pressure has been relieved from the hydraulic circuits before removing any caps, covers, valves, etc.
- All servicing work must be carried out with the utmost care and attention.
- Ladders and platforms used in workshops or in the field must comply with the current safety regulations.
- Disconnect the batteries and label all the controls to warn others that work is being carried out. Block the machine and all implements that must be raised.
- Do not check or fill fuel tanks, batteries, or use ignition fluid when smoking or near naked flames as these liquids are inflammable.
- The brakes are disengaged when released by hand for servicing work: in these cases, the machine must be kept under control by means of chocks or similar.



- The fuel pump nozzle must always remain in contact with the filler. Keep it there until you finish filling so as to prevent sparks from being created through an accumulation of static electricity.
- Only use the prescribed hitching points when towing. Make the connections with care: make sure that the provided pins and/or latches are firmly fixed in place before beginning to tow. Keep well away from tow bars, ropes or chains that are pulling a load.
- If possible, use a trailer or truck with a lowered loading platform when transferring a faulty machine.
- When a machine must be loaded on to or unloaded from the transport vehicle, choose flat ground able to provide a solid bearing surface for the wheels of the trailer or truck. Fasten the machine to the truck or trailer platform firmly and block the wheels as required by the haulage contractor.
- Only use auxiliary power sources with grounding circuits able to prevent electric shocks from electric heaters, battery chargers and similar equipment.
- Use hoists and similar equipment with an adequate carrying capacity if heavy parts must be lifted or transported.
- Pay particular attention to bystanders.
- Never pour petrol or diesel fuel into wide and shallow open vessels.
- Never use petrol, diesel fuel or other inflammable fluids as detergents: use the non-flammable and non-toxic solvents available in the shops.
- Protect your eyes by wearing goggles with side guards when using compressed air to clean parts.
- Limit the pressure to 2.1 bars at most, in compliance with the local or national laws in force.
- Do not run the engine in a closed room without adequate ventilation.
- Do not smoke, use naked flames or create sparks in the vicinity when refuelling or handling easily inflammable materials.
- Do not use flames as a means of lighting when repairing the machine or searching for "leaks".
- Move with the greatest care when working under, on or near the machine. Wear approved safety garments such as helmets, goggles and safety footwear.
- When the engine must be running in order to make the inspections, ask for help from an operator who must remain in the driver's seat and keep the mechanic under visual control at all times.
- If servicing is required away from the workshop, park the machine on flat ground and block it. If work on slopes is unavoidable, block the machine and move it to a horizontal surface as soon as this can be done within a certain safety margin.
- Do not use crushed or bent chains or ropes when lifting or towing are required. Always wear suitably thick gloves to handle them.
- Chains must be firmly fixed in place: make sure that the fastening is sufficiently strong to bear the load in question. Have all bystanders move well clear of the connection, chains or ropes used for lifting or towing.
- The area where the servicing operations are carried out must always be kept CLEAN and DRY. Puddles or water or oil stains must be cleaned up immediately.
- Do not form heaps of rags soaked in grease or oil: they could catch fire very easily. Always put them in a closed metal container.
- Check, regulate and lock the driver's seat before starting the machine or implements. Make sure that there are no bystanders within the range of action of the machine or implements.
- Do not carry objects that could drop unseen into the internal mechanisms of the machine, in your pockets.
- Wear goggles with side guards, helmets, special safety footwear and gloves when you could be struck by metal objects and similar, thrown up during the servicing work.
- Use the necessary safety protections when welding operations are carried out: dark glasses, helmets, dungarees, special gloves and footwear. Dark glasses should also be worn by the people not actually doing the work but who are in the vicinity when welding is being carried out. **NEVER LOOK AT THE WELDING ARC WITHOUT ADEQUATE EYE PROTECTION.**
- Metal ropes become frayed with wear: always protect yourself in an adequate way when handling them (wear gloves, goggles, etc.).



- Handle all parts with the utmost care. Keep your hands and fingers well away from gaps, wheelwork and similar. Always use approved personal protection devices such as safety goggles, gloves and safety footwear.



Before you get on to the tractor, it is essential for you to have read and strictly complied with the instructions in the operation and maintenance manual.

Starting

- Do not allow the engine to run in a closed room without adequate ventilation systems able to dispose of the exhaust gas.
- Never put your head, body, limbs, feet, hands or fingers near spinning fans or belts.

Engine

- Before removing the radiator plug completely, turn it very slowly to relieve the pressure in the circuit. Coolant fluid must only be topped up with the engine at a standstill or idling, if hot.
- Do not refuel whilst the engine is running, particularly if it is hot. This could lead to the risk of a fire outbreak if fuel were to be spilt.
- Do not attempt to check or adjust the tension of the fan belts with the engine running. Do not regulate the fuel injection pump whilst the machine is on the move.
- Never lubricate the machine when the engine is running.

Electrical systems

- If auxiliary batteries must be used, remember that the cables must be connected in the prescribed way at both ends: (+) with (+) and (-) with (-). Do not short-circuit the terminals. **THE GAS ISSUED BY BATTERIES IS HIGHLY INFLAMMABLE.** Always leave the battery compartment uncovered when recharging, to ensure a more efficient ventilation. Never ever check the battery charge using the "jumpers" obtained by placing metal objects on the terminals. Prevent sparks or flames in the battery area. Do not smoke as this could cause explosions.
- Before proceeding with any work, make sure that there are no fuel or electricity leaks: repair these leaks before proceeding.
- Do not recharge batteries in closed places: make sure that there is adequate ventilation to prevent accidental explosions from occurring due to an accumulation of the gas issued when recharging.
- Always disconnect the batteries before working on the electrical system.

Hydraulic circuits

- Fluid leaking from a very small hole can be almost invisible yet have sufficient force to penetrate under the skin. Use a piece of cardboard or wood if you must check for such leaks. **NEVER CHECK FOR LEAKS WITH THE HANDS:** immediately seek medical help if fluid penetrates under the skin. Serious infections or dermatitis may occur if you fail to receive prompt medical treatment.
- Use the right tools to check the pressure in the circuits.



Wheels and tyres

- Make sure that the tyres are correctly inflated to the pressure indicated by the manufacturer. Periodically check the rims and tyres to make sure that they are not damaged.
- Keep to the side of the tyre when correcting the inflation pressure.
- Only check the pressure with the machine unloaded and the tyres cold, to prevent incorrect measurements and overpressures. Do not reuse repaired wheel parts as badly made welds, brazing or heating could have weakened them and cause breakage.
- Never cut or weld a rim with a tyre mounted and inflated.
- Block the machine at the front and rear on all wheels before demounting these latter. After you have jacked up the machine, prevent it from dropping by placing supports underneath, in compliance with the current laws in force.
- Deflate the tyres before removing any objects jammed between the treads.
- Never inflate the tyres with inflammable gas. This could lead to explosions and injure bystanders.

Unhitching and re-hitching

- Lift and handle all heavy parts with lifting equipment of an adequate capacity. Make sure that the parts are supported by appropriate harness and hooks. Use the lifting eyelets provided. Take care of bystanders near the load being lifted.
- Handle all parts with the utmost care. Do not put your hands or fingers between one part and the next. Wear approved safety garments such as goggles, gloves and safety footwear.
- Do not twist metal ropes or chains. Always wear safety gloves when handling cables or chains.



GENERAL INSTRUCTIONS

IMPORTANT WARNING

All the maintenance operations and repairs described in this manual must be carried out by the MF assistance network only, in strict compliance with the indications given and using special tools if necessary.

Anyone who carries out the described operations without strictly complying with the instructions becomes personally responsible for any consequent damage.

Battery

Before proceeding with any work, disconnect and insulate the negative battery cable unless other instructions are given for the specific operation required (for example: an operation where the engine must be running). After the operation has been terminated, detach this cable in order to finish the work.

Adjuster shims

Whenever adjustments are made, select the adjuster shims by measuring them one by one with a micrometre and then adding the values gauged: do not trust in the erroneous measurement of the complete pack or in the nominal value given for each ring.

Spinning shaft seals

Comply with the following instructions to correctly mount the spinning shaft seals:

- before they are mounted, allow the seals to soak for at least half an hour in a bath of the same type of oil as that they will be sealing;
- thoroughly clean the shaft and make sure that its operating surfaces are not damaged;
- position the sealing lip towards the fluid. If the lip is the hydrodynamic type, the direction in which the scoring points (considering the direction in which the shaft spins) must tend to make the fluid flow towards the internal part of the seal;
- spread a film of lubricant (oil is preferable to grease) on the sealing lip and fill the gap between the sealing lip and dust guard lip of double-lipped seals with grease;
- fit the seal into its housing by pressing or use a punch with a flat contact surface. Never hit the seal with a hammer or mallet;
- when a seal is mounted, make sure that it is inserted perpendicular to its housing. After mounting, make sure that it touches the supporting ridge (if applicable);
- to prevent the seal lip from being damaged by the shaft, fit an adequate guard whilst the two parts are being assembled.

O-ring toroid seals

Lubricate the o-ring seals before they are fitted into their housings to prevent them from rolling around themselves and becoming twisted as they are mounted, something that would compromise their sealing ability.

Bearings

It is advisable to proceed in the following way when mounting bearings:

- heat them to 80 – 90 °C before fitting them on to their respective shafts;
- cool them before externally fitting them into their housings.

Spring pins

When mounting split tube spring pins, make sure that their notches point in the direction of the force exercised on the pin itself.

Spiral spring pins do not need to be set in any direction when mounted



Notes about spare parts

Only use genuine MF spare parts as only these are able to guarantee the same quality, life and safety as the original components mounted on your machine.

Only **genuine MF spare parts** can provide this guarantee.

Give the following information when ordering spare parts:

- tractor model (commercial denomination) and chassis number;
- engine type and number;
- order number of the required part, which can be found in the "Spare Parts Catalogue", according to which the orders are fulfilled.

SPECIFIC EQUIPMENT

The equipment that MF proposes and illustrates in this manual is:

- explicitly researched and designed for work on MF tractors;
- necessary for reliable repairs;
- carefully made and thoroughly tested to provide efficient and long-lasting tools.













Repairers should also remember that using the right equipment means:

- working in technically optimum conditions;
- obtaining the best result;
- saving time and effort;
- working in greater safety.





**SYMBOLS****Meaning and use**

Certain symbols are used in this manual to underline and draw the reader's attention to certain particular aspects of the description, or to indicate the type of operation being illustrated.

The meanings of the various symbols used are described in the table below.

SYMBOL	MEANING	NOTES
	Warning: personal risk	Indicates a danger with the risk of even mortal accident for the user. Pay the utmost attention to the texts indicated with this symbol.
	Warning: environmental hazard	Indicates a danger with the risk of damage to the natural environment. Pay the utmost attention to the texts indicated with this symbol.
	Caution	Warns that the machine or some other personal property of the user could be damaged.
	Note	Indicates a warning, a note about key functions or some other useful information.
	Prevent damage to material	This indication means that there is a considerable risk of damage to a part, e.g. when the wrong tool is used or an assembly made by means of an incorrect procedure.
	Special tool/ specific equipment	A special tool or specific equipment must be used for the operations.
	Visual observation	A visual inspection must be made. The user must read a measurement value, check an indication, etc...
	Listen	The operator must listen to a noise made when the machine operates. The inspection serves to identify abnormal noise.
	Tighten and torque	Symbol associated with a value: use a torque wrench to suit the value given and measure the dwell angle at that torque value.
	Torquing with angle	Symbol associated with two values: use a torque wrench to suit the value given and measure the dwell angle at that torque value.
	Adjustment/Regulation	Operation carried out in order to obtain precise values (pressure, preload, relative distance, etc.).
	Measuring/Gauging	Operation carried out in order to measure required to restore optimum functional conditions in the correct way.



SYMBOL	MEANING	NOTES
	Lubrication	Lubrication (oiling, greasing, etc...) of a part/ device.
	Sealing/Gluing	Sealant required in order to couple two parts together.
	Positioning	Coupling with relative position references.
	MF Spares.	Indicates that only MF spare parts must be used.



DANGER SIGNS

If a tractor part bearing a decal with a safety note (yellow colour) is replaced, it is ESSENTIAL to affix the same decal to the spare part.

A complete list of all the places where decals are applied is given below.

Positions of the danger decals - WEO markets

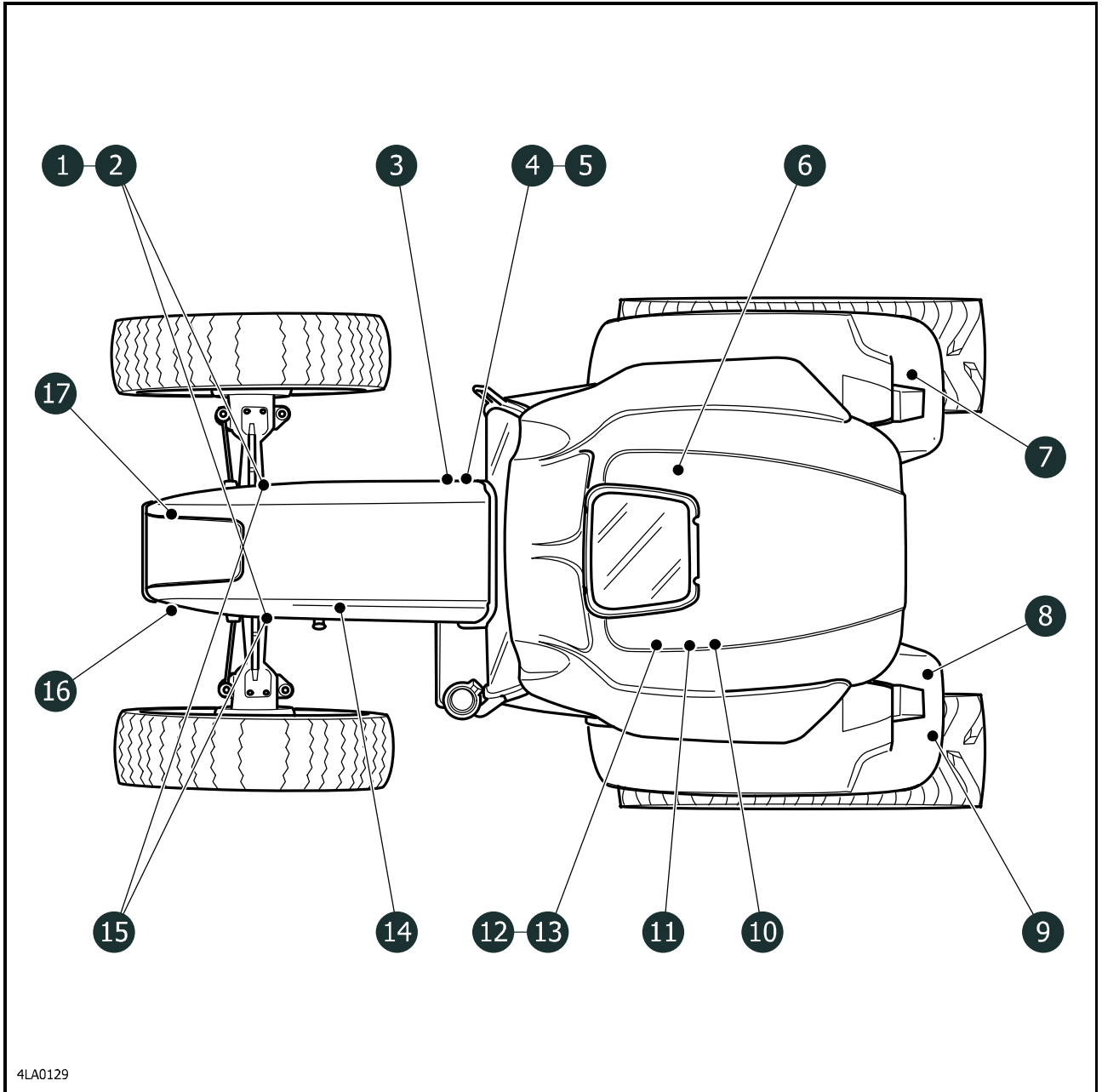

Positions of the danger decals
Complete set of danger decals N. 3559 552 M95



REF.	CODE	POSITION	DESCRIPTION	SYMBOL
1	3559 556 M1	On the left and right sides of the radiator or manifold.	WARNING: Danger of entanglement. Keep your hands well clear of the fan blades when the engine is running. Always keep the guards and screens mounted.	
2	3559 559 M1	On both sides of the radiator.	WARNING: Danger of entanglement. Keep your hands well clear of spinning parts. Take care not to become entangled in the belts or pulleys whilst the engine is running. Keep the guards in place.	
3	3647 157 M1	Near the brake circuit oil reservoir.	WARNING: Risk of damage to the brake circuit. Carefully read the danger warnings and the instructions shown in the operation and maintenance manual before starting maintenance operations.	
4	3559 555 M1	On the starter motor.	WARNING: Electric shock. Always disconnect the negative battery terminal before removing the cover of the solenoid and before servicing the electrical system.	
5	3648 152 M1	On the starter motor.	DANGER: Danger of being crushed. DO NOT start the engine by shorting across the terminals of the starter motor. This operation will place your life in danger. Only start the engine when you are sitting in the driving seat.	



Suggest:





For more complete manuals. Please go to the home page.

<https://www.ebooklibonline.com>

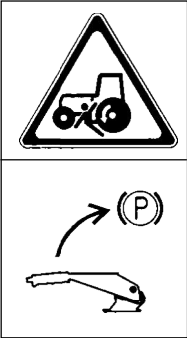

If the above button click is invalid. Please download this document first, and then click the above link to download the complete manual.

Thank you so much for reading



REF.	CODE	POSITION	DESCRIPTION	SYMBOL
6	3647 643 M1	Near handbrake lever.	DANGER: Danger of being crushed. When stopping the tractor, always apply the parking handbrake before getting off.	
7	3647 299 M1	On the right rear mudguard, with electronic power lift only.	DANGER: Danger of collisions and severe accidents. Stand by the side of a tractor when using the external power lift controls. DO NOT STAND between the tractor and the tool: you could be hit.	
8	3559 553 M1	On the inside of the rear mudguard.	DANGER: Danger of entanglement. Keep well away from spinning shafts. Take care NOT to remain caught up by the PTO driveline. Keep all the guards mounted on the transmission shafts of the tractor or implements.	
9	3647 463 M1	On the left rear mudguard, with electronic power lift only.	DANGER: Danger of collisions and severe accidents. Stand by the side of a tractor when using the external power lift controls. DO NOT STAND between the tractor and the tool: you could be hit.	

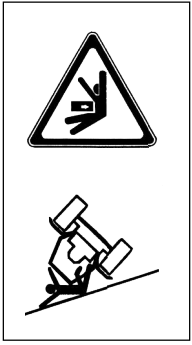
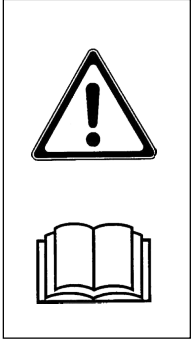

REF.	CODE	POSITION	DESCRIPTION	SYMBOL
10	3647 032 M1	Inside cab on top for tractors without second passenger seat and for tractors with frame on left mudguard	WARNING: Danger of being crushed. DO NOT allow anyone to sit on the mudguards or on any other part of the tractor or towed implements.	
11	3648 447 M1	Tractors with seat belts. On the pillar inside the cab or on the left mudguard for tractors with safety frame.	WARNING: Danger of being crushed. Always wear the seat belt when the safety frame is in the vertical position.	
12	3559 557 M1	Inside the cab on top or on the left mudguard for tractors with safety frame.	DANGER: The tractor could overturn and crush your chest. Hold firmly on to the steering wheel if the tractor is overturning. DO NOT leave your seat or jump off the tractor.	
13	3559 558 M1	Inside the cab on top or on the left mudguard for tractors with safety frame.	WARNING: Pay attention. Consult the operation and maintenance manual for information about safety and how to use the tractor.	

<https://www.ebooklibonline.com>

Hello dear friend!

Thank you very much for reading.

Enter the link into your browser.

The full manual is available for immediate download.

<https://www.ebooklibonline.com>