



## TABLE OF CONTENTS

Chap. 1 INTRODUCTION

Chap. 2 SPLITTING THE ASSEMBLIES

Chap. 3 ENGINE

Chap. 4 CLUTCH

Chap. 5 TRANSMISSION

Chap. 6 4WD FRONT AXLE

Chap. 7 POWER TAKE-OFF

Chap. 8 HYDRAULIC CIRCUIT

Chap. 9 ELECTRONIC POWER LIFT

Chap. 10 CAB

Chap. 11 ELECTRICAL SYSTEM

Chap. 12 SPECIAL TOOLS



CHAP.1

**INDEX**

<b>Sect. 1</b>	<b>Reading the manual</b> .....	1-3
	1-1 Introduction .....	1-4
	1-2 Structure of the manual.....	1-4
<b>Sect. 2</b>	<b>Tractor identification and technical specifications</b> .....	1-5
	2-1 Tractor identification .....	1-6
	2-2 Weights and dimensions .....	1-7
	2-3 Engine specifications .....	1-8
	2-4 Clutch specifications .....	1-9
	2-5 Transmission specifications .....	1-9
	2-6 Power take-off specifications .....	1-12
	2-7 2WD axle .....	1-12
	2-8 4WD front axle specifications (DNX) .....	1-13
	2-9 Specifications of 4WD front axle with bevel gear pairs .....	1-14
	2-10 Hydraulic circuit specifications .....	1-15
<b>Sect. 3</b>	<b>Working in safety</b> .....	1-17
	3-1 Essential rules for accident prevention .....	1-18
	3-2 Danger decals .....	1-24
	3-3 Replacing tractor parts .....	1-25
	3-4 Safe use of the tractor.....	1-25
<b>Sect. 4</b>	<b>Pre-delivery inspections and maintenance</b> .....	1-27
	4-1 General information .....	1-28
	4-2 Inspections before delivery .....	1-28
	4-3 Routine maintenance guide .....	1-29



CHAP.1

<b>Sect. 5 Conversion tables.</b> .....	1-31
5-1 Length .....	1-32
5-2 Area .....	1-35
5-3 Volume .....	1-36
5-4 Weight .....	1-39
5-5 Pressure .....	1-41
5-6 Moment of rotation .....	1-43
5-7 Temperature .....	1-45
<b>Sect. 6 Sealants.</b> .....	1-47
<b>Sect. 7 Table of bolt driving torques.</b> .....	1-49
<b>Sect. 8 General assembly instructions.</b> .....	1-51
8-1 Seals .....	1-52
8-2 O-Ring seals .....	1-53
8-3 Bearings .....	1-54

**<https://www.ebooklibonline.com>**

Hello dear friend!

Thank you very much for reading.

Enter the link into your browser.

The full manual is available for immediate download.

**<https://www.ebooklibonline.com>**



CHAP. 1

# Reading the manual

## INDEX

### Sect.1 Reading the manual

1-1 Introduction .....	1-4
1-2 Structure of the manual .....	1-4



## Sect.1 - Reading the manual

### 1-1 Introduction

The purpose of this manual is to provide the owner and user of **MF 2210 - 2225 - 2235** tractors with clear instructions on how to split the tractor parts.

It is designed for use by the workshop head since it does not give details about the disassembly, re-assembly and adjustment operations for all the assemblies, but just for those that require particular knowledge or recommendations.

**Before reading the manual, it is essential to read sect.3: WORKING IN SAFETY in order to prevent errors or mistakes that could jeopardize the safety of the technicians in the workshop.**

The information in this manual was up to date at the time of publication. Massey Ferguson reserves the right to make modifications without being obliged to give notice.

Please contact your area dealer or the importer if discrepancies are discovered or for any other requirement.

### 1.2 Structure of the manual

The manual is divided into chapters (chap.) and each chapter into sections (sect.). Page numbering begins with 1 for each chapter with the number of the chapter itself alongside.

**Example:** 5-7 indicates page 7 of chapter 5.

Numbering of the figures also begins with 1 in each chapter with the chapter number alongside.

**Example:** Fig. 73-5, indicates figure 73 of chapter 5.

The tools required for all the disassembly, re-assembly and adjustment operations are listed at the end of each chapter or important section. Not all the tools listed at the end of the chapter or section are, however, mentioned in the text, just those considered essential for correct disassembly, re-assembly and adjustment of the assembly in question.

The constructional drawings of all the tools described in the various chapters or sections are listed in chapter 12 to allow the dealer to provide his workshop with all those considered of importance.



# Tractor identification and technical specifications

## INDEX

### Sect.2 Tractor identification and technical specifications

2-1 Tractor identification .....	1-6
2-2 Weights and dimensions .....	1-7
2-3 Engine specifications .....	1-8
2-4 Clutch specifications .....	1-9
2-5 Transmission specifications .....	1-9
2-6 Power take-off specifications .....	1-12
2-7 2WD axle .....	1-12
2-8 4WD front axle specifications (DNX) .....	1-13
2-9 Specifications of 4WD front axle with bevel gear pairs .....	1-14
2-10 Hydraulic circuit specifications .....	1-15



## Sect. 2 - Tractor identification and technical specifications

### 2-1 Tractor identification

The tractor is identified by a serial number stamped on the rear part of the transmission housing and on the bonnet. The engine also has its own serial number stamped on the engine block.

To ensure a quick and efficient service when ordering spare parts or asking for technical specifications or other information, always state the chassis and engine serial number.

Chassis serial number .....

Engine serial number .....

Cab serial number .....

Type of tractor .....

Owner / Operator .....

Dealer's or Agent's address .....

Delivery date .....

Warranty expiry date .....

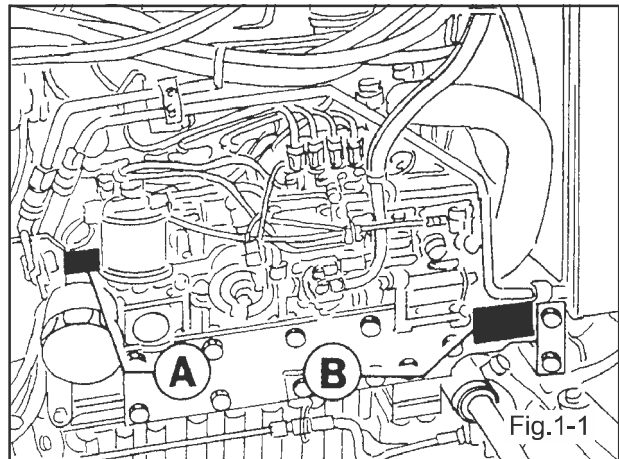

**A - Engine serial number**  
(engine block)  
**B - Chassis type and serial number**  
(on front radiator core)

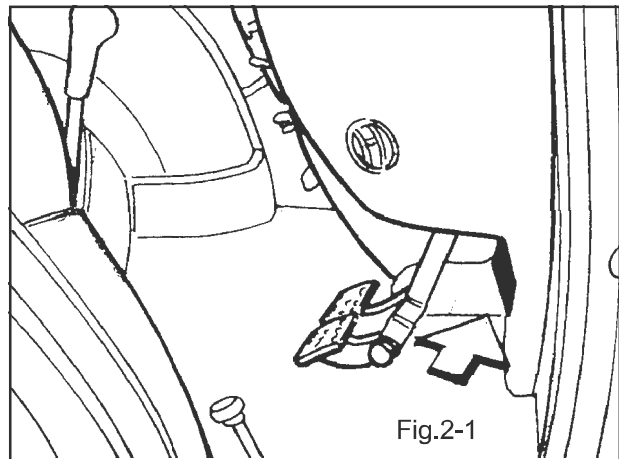

**Type of tractor and chassis serial number**  
(lower dashboard panel).

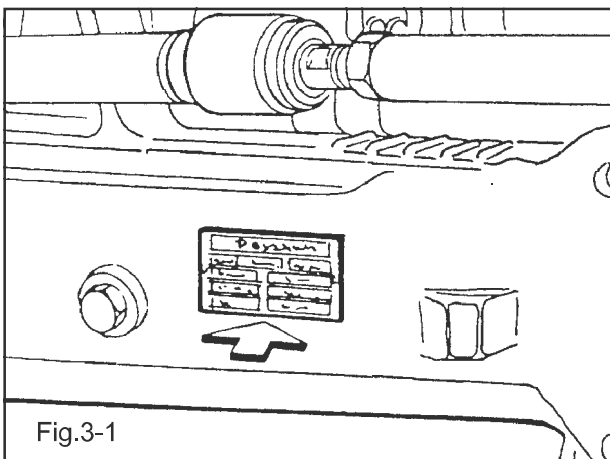

**Type and serial number of the front axle**  
(on axle housing).

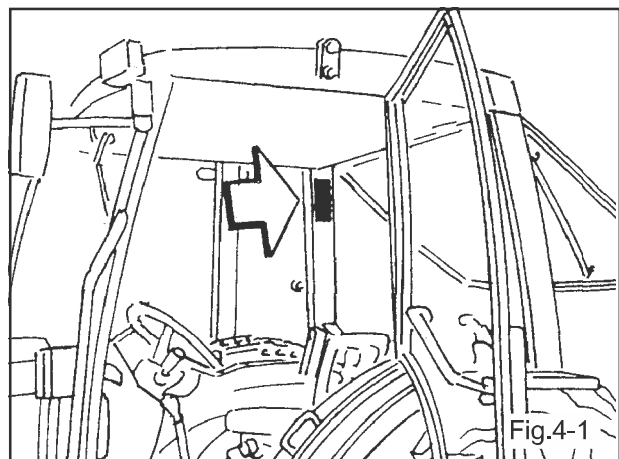

**Cab type and serial number**  
(on rear cab pillar).



# Tractor identification and technical specifications

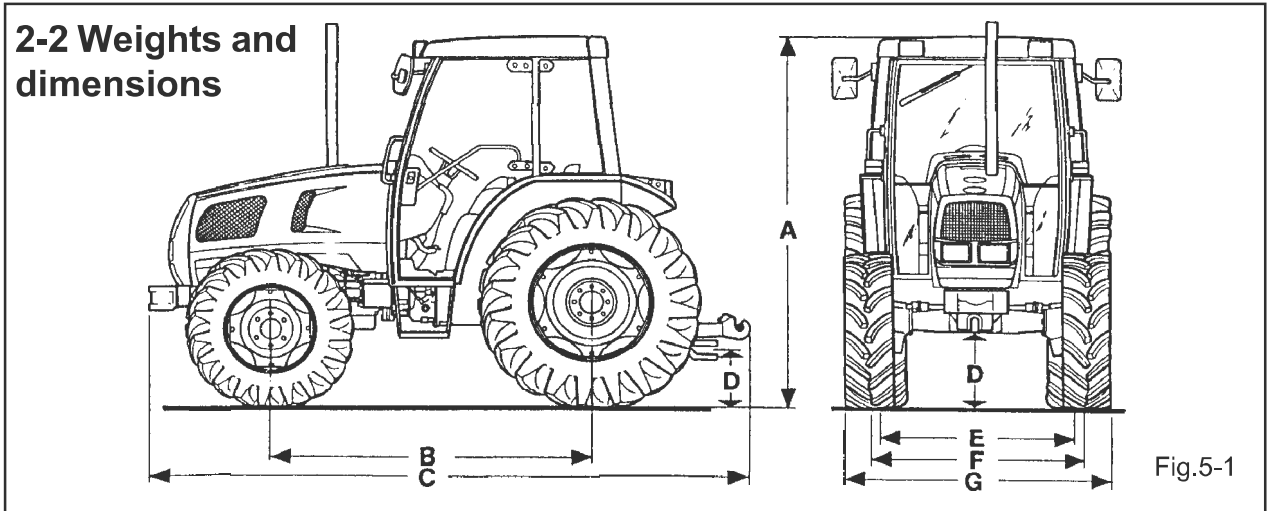

GENERAL SPECIFICATIONS	MF 2210		MF 2225		MF 2235		
	2WD	4WD	2WD	4WD	2WD	4WD	
With tyres:							
- Front	750-16	320/70 R20	7.50-16	320/70 R24	7.50-16	320/70 R24	
- Rear	14.9 R28	420/70 R28	480/70 R30	480/80 R30	480/80 R30	480/70 R30	
<b>WEIGHTS</b>							
In running order,							
with cab without ballast	kg	2350	2470	2350	2550	2350	2550
with front / rear ballast	kg	2850	3000	2880	3080	2880	3080
<b>DIMENSIONS</b>							
A - Height at cab	mm	2360	2423	2360	2445	2360	2445
B - Wheelbase	mm	2006	2006	-	2154	-	2154
C - Maximum length							
- without front ballast	mm	3650	3605	-	3708	-	3708
- with front ballast	mm	3915	3915	-	4017	-	4017
D - Ground clearance:							
- under tow hook	mm	250	395	270	455	270	455
- under front axle	mm	-	445	-	415	-	415
E - Rear track (see tables)	mm	1320-1620	1436-1696	1320-1620	1578-1848	1320-1620	1578-1848
F - Front track (see tables)	mm	1354-1850	1562-1962	1562-1962	1562-1962	1562-1962	1562-1962
G - Maximum width:							
- front axle	mm	2245	2270	2348	2348	2348	2348
- rear axle	mm	1732	1755	-	1549	-	1549



# Tractor identification and technical specifications

SHERPA SPECIFICATIONS		MF 2210	MF 2225
With tyres: Front - Rear		280/70-R20 14.9 - R28	300/70-R20 420/70-R28
<b>WEIGHTS</b>			
In running order, with cab without ballast	kg	2430	2500
with front / rear ballast	kg	2960	3030
<b>DIMENSIONS</b>			
A - Height at cab	mm	2354	2385
B - Min/max width	mm	1732/2244	1777/2286
C - Ground clearance	mm	335	345
D - Wheelbase	mm	1996	2123
E - Max length (with 2 ballasts)	mm	3904	3904
F - Tracks: Front min/max	mm	1325/1675	1325/1675
Rear min/max	mm	1354/1866	1354/1866

## 2-3 Engine specifications

ENGINE	MF 2210	MF 2225	MF 2235
Type:	Perkins diesel, with direct injection		
Model	903.27	1004.40	1004.42
Aspiration	Natural	Natural	Natural
Number of cylinders	3	4	4
Bore	mm	95	100
Stroke	mm	127	127
Swept volume	liters	2.7	3.99
Compression ratio		17.25:1	17.25:1
Power(DIN 700200)	HP/kW	54/39.7	66/48.6
Max. speed under load	RPM	2300	2200
Max. speed with no load	RPM	2475	2375
Max. torque (DIN 70020)	Nm	193.1	-
Max. torque speed	RPM	1350	-
Idling rate	RPM	750	750
<b>VALVE GEAR</b>			
Type	Overhead valves controlled by tappets		
tappet gap with engine cold:			
- Intake (mm)	0.20	0.20	0.20
- Exhaust (mm)	0.45	0.45	0.45
<b>FUEL SYSTEM</b>			
Fuel pump	AC-DELCO	AC-DELCO	AC-DELCO
Injection pump	ROTARY LUCAS DP 202	ROTARY LUCAS DP 202	ROTARY LUCAS DP 202
Filter on injection pump delivery	CAV	CAV	CAV
Injection order	1-2-3	1-3-4-2	1-3-4-2
Injectors	PERKINS	PERKINS	PERKINS
Injector pressure setting (bar)	296	296	290
Cold starting device	Thermostarter		
Air filter	Dry, with two elements removable for maintenance		



# Tractor identification and technical specifications

## 2-4 Clutch specifications

<b><u>Manufacturer</u></b>	LX (OX)
<b><u>Type</u></b>	Single-plate (with hydraulic PTO) Double-plate (with mechanical PTO)
<b><u>Dimensions</u></b>	11" (280 mm.) Single-plate (MF 2210-2225) 11" (245/280 mm.) Double-plate (MF 2210-2225) 12" (304.8 mm.) Single-plate (MF 2235) 12"/11 (304.8/880 mm.) Double-plate (MF 2235)
<b><u>Material</u></b>	Gearshift plate with 5 cerametallic plaques Organic PTO plate

## 2-5 Transmission specifications

<b><u>Manufacturer</u></b>	<b><u>Massey Ferguson</u></b>
<b><u>Gearbox</u></b>	
Speeds	Four synchronized speeds with infinitely meshed helical gears
Type of reduction ranges	Three forward ranges (Slow-Normal-Fast) Creeper (7.333 reduction).
Reverse shuttle	Synchronized on gearbox input
Number of speeds	12 forward and 12 reverse speeds with standard gearbox 15 forward and 15 reverse speeds with optional 24 forward and 24 reverse speeds with creeper 30 forward and 30 reverse speeds with optional gearbox 48/60 forward and 48/60 reverse speeds with Hi-Lo
<b><u>Rear axle</u></b>	
Bevel gear pair	9/37 with helical toothing, Gleason type (MF 2210) 11/41 with helical toothing, Gleason type (MF 2225-2235)
Final reduction	Straight-tooth type with 10/51 or 11/49 ratios (MF 2210) or 11/62 ratio (MF 2225-2235)
Total reduction ratio	23.23 or 20.29
Type of Differential	With two planetaries
Differential lock	With mechanical or electrohydraulic control, mechanically engaged Disengaged by means of the brakes (electrohydraulic control)
<b><u>Rear brakes</u></b>	
Type	Oil cooled multiple-plate type
Number of friction disks	8 (4 each side)
Friction disk material	Graphitized resin
Disk diameter	166x110 mm
Total braking area	1900 cm <sup>2</sup>
Diameter of braking cylinder	25.4 mm
Parking brake	Mechanical, engaged by a hand lever
<b><u>Rear brakes</u></b> (4WD axle)	
Type	Oil cooled multiple plate
Number of friction disks	8 (2 each side)
Friction disk material	Graphitized resin
Disk diameter	143x91 mm
Total braking area	764.5 cm <sup>2</sup>















# INTRODUCTION



## Tractor identification and technical specifications

MF 2210 Speed in kph with 2200 RPM engine rate.

Gearbox: 4 gears = 30 kph; 5 gears = 40 kph

	Option	Range	Gear	Hi-Lo Engaged			Hi-Lo Disengaged		
				12.4R28 420/70R24	13.6R28 380/70R28	14.9R28 420/70R28 12.4R32	12.4R28 420/70R24	13.6R28 380/70R28	14.9R28 420/70R28 12.4R32
<b>FORWARDSPEEDS</b>	<b>CREEPER*</b>	 Slow	1	0.16	0.16	0.17	0.19	0.20	0.21
			2	0.21	0.22	0.24	0.26	0.27	0.28
			3	0.30	0.32	0.34	0.37	0.39	0.40
			4	0.41	0.42	0.45	0.50	0.51	1.54
			5	0.55	0.56	0.60	0.66	0.68	0.72
		 Standard	1	0.43	0.45	0.48	0.52	0.54	0.57
			2	0.58	0.60	0.63	0.70	0.72	0.76
			3	0.82	0.86	0.90	0.99	1.03	1.08
			4	1.11	1.14	1.20	1.33	1.37	1.44
	 Fast*	1	1.18	1.22	1.29	1.42	1.47	1.54	
		2	1.59	1.64	1.73	1.91	1.97	2.07	
		3	2.27	2.34	2.46	3.63	3.75	3.94	
4		3.03	3.13	3.29	3.63	3.75	3.94		
5		4.03	4.17	4.38	4.83	5.00	5.25		
<b>STANDARDSPEEDS</b>	 Slow	1	1.19	1.23	1.29	1.43	1.48	1.56	
		2	1.60	1.65	1.74	1.92	1.98	2.08	
		3	2.28	2.36	2.48	2.74	2.83	2.97	
		4	3.04	3.15	3.31	3.65	3.78	3.96	
		5	4.06	4.20	4.40	4.86	5.03	5.27	
	 Standard	1	3.19	3.30	3.47	3.83	3.96	4.15	
		2	4.28	4.42	4.64	5.13	5.30	5.56	
		3	6.11	6.32	6.63	7.32	7.57	7.94	
		4	8.15	8.42	8.85	9.76	10.09	10.59	
 Fast	1	8.73	9.02	9.46	10.45	10.80	11.33		
	2	11.68	12.08	12.68	13.99	14.47	15.18		
	3	16.68	17.24	18.04	19.97	20.64	21.59		
	4	22.25	23.00	24.13	26.64	27.54	28.89		
	5	29.62	30.63	32.14	35.46	36.67	38.47		
<b>REVERSESPEEDS</b>	<b>CREEPER</b>	 Slow	1	0.16	0.16	0.17	0.20	0.20	0.21
			2	0.21	0.22	0.24	0.26	0.27	0.29
			3	0.31	1.32	1.34	1.38	0.39	0.41
			4	0.41	0.43	0.45	0.50	0.52	0.54
			5	0.55	0.57	0.61	0.67	0.69	0.73
		 Standard	1	0.44	0.45	0.48	0.53	0.54	0.57
			2	0.59	0.61	0.64	0.71	0.73	0.77
			3	0.84	0.87	0.91	1.01	1.04	1.09
			4	1.11	1.16	1.22	1.34	1.39	1.46
	 Fast	1	1.21	1.25	1.32	1.45	1.50	1.58	
		2	1.62	1.68	1.76	1.95	2.02	2.11	
		3	2.32	2.39	2.52	2.78	2.87	3.02	
4		3.09	3.20	3.36	3.71	3.83	4.02		
5		4.12	4.27	4.48	4.94	5.11	5.36		
<b>STANDARDSPEEDS</b>	 Slow	1	1.21	1.25	1.31	1.45	1.50	1.57	
		2	1.62	1.67	1.75	1.94	2.00	2.10	
		3	2.31	2.39	2.51	2.77	2.86	3.00	
		4	3.08	3.19	3.34	3.69	3.82	4.00	
		5	4.10	4.24	4.45	4.91	5.08	5.33	
	 Standard	1	3.23	3.34	3.51	3.87	4.00	4.20	
		2	4.32	4.48	4.69	5.18	5.36	5.62	
		3	6.18	6.39	6.70	7.40	7.65	8.02	
		4	8.23	8.52	8.94	9.86	10.20	10.70	
 Fast	1	8.82	9.12	9.57	10.56	10.92	11.46		
	2	11.82	12.22	12.82	14.15	14.63	15.35		
	3	16.85	17.42	18.29	20.18	20.86	21.89		
	4	22.48	23.35	24.39	26.92	27.83	29.20		
	5	29.94	30.96	32.48	35.84	37.06	38.88		











# INTRODUCTION



## Tractor identification and technical specifications

MF 2225-2235 Speed in kph with 2200 RPM engine rate.

Gearbox: 4 gears = 30 kph; 5 gears = 40 kph

	Option	Range	Gear	Hi-Lo Engaged			Hi-Lo Disengaged		
				14.9R 30	16.9R 28	16.9R 24	14.9R 30	16.9R 28	16.9R 24
				480 / 70R 30	540 / 65R 28		480 / 70R 30	540 / 65R 28	
<b>FORWARDSPEEDS</b>	<b>CREEPER</b>	 Slow	1	0.18	0.17	0.16	0.22	0.21	0.19
			2	0.24	0.23	0.21	0.29	0.28	0.26
			3	0.35	0.33	0.31	0.42	0.40	0.37
			4	0.46	0.45	0.41	0.56	0.54	1.50
			5	0.62	0.60	0.55	0.74	0.71	0.66
		Standard	1	0.49	0.47	0.43	0.58	0.56	0.52
			2	0.65	0.63	0.58	0.78	0.75	0.70
			3	0.93	0.90	0.83	1.12	1.08	1.00
			4	1.25	1.20	1.11	1.49	1.44	1.33
			5	1.66	1.60	1.48	1.99	1.92	1.77
		 Fast	1	1.33	1.29	1.19	1.60	1.54	1.42
			2	1.79	1.72	1.59	2.14	2.06	1.91
	3		2.55	2.46	2.28	3.06	2.95	2.73	
	4		3.41	3.28	3.04	4.08	3.93	3.64	
	5		4.54	4.37	4.05	5.43	5.24	4.85	
	Standard		1	1.34	1.29	1.20	1.61	1.55	1.43
		2	1.80	1.73	1.60	2.15	2.08	1.92	
		3	2.57	2.48	2.29	3.08	2.96	2.74	
		4	3.43	3.30	3.06	4.10	3.95	3.66	
		5	4.56	4.40	4.07	5.46	5.27	4.87	
	 Standard	1	3.59	3.46	3.20	4.30	4.15	3.84	
		2	4.81	4.64	4.29	5.77	5.56	5.14	
		3	6.87	6.62	6.13	8.23	7.93	7.34	
		4	9.16	8.83	8.17	10.97	10.58	9.79	
		5	12.20	11.76	10.88	14.61	14.08	13.03	
		 Fast	1	9.81	9.46	8.75	11.75	11.32	10.48
	2		13.14	12.67	11.72	15.74	15.17	14.04	
	3		18.75	18.07	16.72	22.45	21.64	20.03	
	4		25.01	24.11	22.31	29.95	28.87	26.72	
	5		33.30	32.10	29.71	39.88	38.44	35.57	
<b>REVERSESHUTTLE</b>	<b>CREEPER</b>		 Slow	1	0.18	0.17	0.16	0.22	0.21
		2		0.24	0.24	0.22	0.29	0.28	0.26
		3		0.35	1.34	1.31	1.42	0.40	0.37
		4		0.47	0.45	0.42	0.56	0.54	0.50
		5		0.62	0.60	0.56	0.75	0.72	0.67
		Standard	1	0.49	0.47	0.44	0.59	0.57	0.53
			2	0.56	0.64	0.59	0.79	0.76	0.70
			3	0.94	0.91	0.84	1.13	1.09	1.01
			4	1.26	1.21	1.12	1.51	1.45	1.34
			5	1.68	1.62	1.50	2.01	1.94	1.79
		 Fast	1	1.35	1.30	1.20	1.61	1.56	1.44
			2	1.81	1.74	1.61	2.16	2.09	1.93
	3		2.58	2.49	2.30	3.09	2.98	2.76	
	4		3.44	3.32	3.07	4.12	3.98	3.68	
	5		4.59	4.42	4.09	5.49	5.29	4.90	
	 Slow		1	1.36	1.31	1.21	1.62	1.57	1.45
		2	1.82	1.75	1.62	2.18	2.10	1.94	
		3	2.60	2.50	2.31	3.11	3.00	2.77	
		4	3.46	3.34	3.09	4.15	4.00	3.70	
		5	4.61	4.44	4.11	5.52	5.32	4.92	
		 Standard	1	3.63	3.50	3.24	4.35	4.19	3.88
	2		4.87	4.69	4.34	5.83	5.62	5.20	
	3		6.94	6.69	6.19	8.32	8.02	7.42	
	4		9.26	8.93	8.26	11.09	10.69	9.89	
	5		12.33	11.88	11.00	14.76	14.23	13.17	
	 Fast		1	9.91	9.56	8.84	11.87	11.44	10.59
		2	13.28	12.80	11.85	15.91	15.33	14.19	
		3	18.95	18.27	16.90	22.69	21.87	20.24	
		4	25.28	24.37	22.55	30.27	29.18	27.00	
		5	33.66	32.45	30.02	40.30	38.85	35.95	



# Tractor identification and technical specifications

## 2-6 Power take-off specifications

<b>Type:</b>	Independent
<b>Type of clutch:</b>	Mechanical with two speeds 540/750 or 540/1000 RPM  Electrohydraulic with 2 or 4 speeds engaged by a hydraulic clutch and with electrohydraulic control
<b>PTO output shaft</b>	In compliance with Asae standards 13/8 (34.9 mm) with 6 splines
<b>PTO speed</b>	Rotation rate  540 RPM with engine at 2070 RPM  540 ECO RPM with engine at 1339 RPM (Basic assembly). (2-speed PTO).  540 ECO RPM with engine at 1373 RPM (on request). (4-speed hydraulic PTO).  1000 RPM with engine at 2107 RPM (on request). (4-speed hydraulic PTO).  540 RPM PTO with drive reversal with engine at 2061 RPM (on request 4-speed PTO in certain markets only).  PTO proportional to ground speed (MF 2210); PTO shaft turns per wheel revolution: 10.677 (10 / 51 rear final drives).  PTO proportional to ground speed (MF 2225-2235); PTO shaft turns per wheel revolution: 10.769 (11 / 62 rear final drives).

## 2-7 2WD axle

<b>Type:</b>	Boxed and swivelling around the central pivot
<b>N° tracks</b>	4
<b>Min. track width</b>	1320 mm
<b>Max. track width</b>	1620 mm
<b>Track width increases</b>	100 mm
<b>Max. turning angle</b>	55°
<b>Max. angle of oscillation</b>	12°

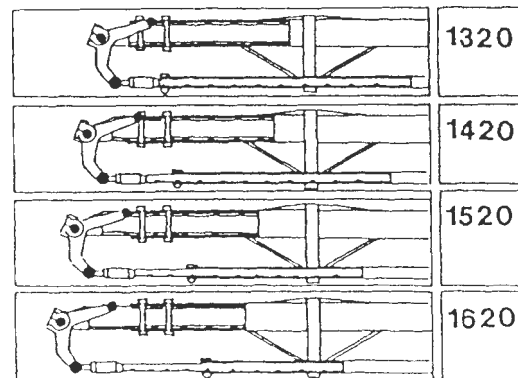

Fig. 6-1



# Tractor identification and technical specifications

## 2-8 4WD (DNX) front axle specifications

<b>Type of axle</b>	In spheroidal cast iron, oscillating with central pivot
<b>Type of reductions</b>	Standard axle with central pinion and ring gear (MF 2210-2225):39/8 Standard axle with central pinion and ring gear (MF 2235):53/13 Sherpa axle with central pinion and ring gear (MF 2210-2225):41/9 Sherpa axle with central pinion and ring gear (MF 2210-2225):51/13 Standard axle with dropped final drive (MF 2210-2225):47/11 Sperpa axle dropped final drive 4.6
<b>Clutch control</b>	Mechanical with hand lever or electrohydraulic
<b>Ratio between front and rear axle</b>	1.430 with 4 WD 2.500 with Fast Run
<b>Type of hydraulic clutch</b>	Hydraulic clutch for 4 WD with oil-cooled disks electrohydraulic control with 1:1 input/output ratio Hydraulic clutch with oil-cooled disks for Fast Run with automatic engagement when the steering angle exceeds 35°. Input/output ratio 1:1.78
<b>Max. steering angle</b>	55°
<b>Max. angle swing</b>	8°
<b>Turning radius</b>	3054 mm.



# Tractor identification and technical specifications

## 2-9 Technical specifications of 4WD front axle with bevel gear pairs

<b>Type of axle</b>	In spheroidal cast iron swivelling around a central pivot
<b>Type of reductions</b>	Central pinion and ring gear 14/32 20/26 and 18/41 double bevel drive and 3.333 epicyclic final drive
<b>Clutch control</b>	Mechanical with hand lever or electrohydraulic
<b>Ratio between front and rear axle</b>	1.430 with 4WD 2.543 with Fast Run
<b>Type of hydraulic clutch</b>	Hydraulic clutch for 4WD with oil-cooled disks, electrohydraulic control and 1:1 input/output ratio Hydraulic clutch with oil-cooled discs for Fast Run with automatic engagement when the steering angle exceeds 35°. 1:1.78 input/output ratio
<b>Max. steering angle</b>	52°
<b>Max. axle swing</b>	8°
<b>Turning radius</b>	3054 mm.



**Suggest:**

**For more complete manuals. Please go to the home page.**

**<https://www.ebooklibonline.com>**

**If the above button click is invalid. Please download this document first, and then click the above link to download the complete manual.**

**Thank you so much for reading**



# Tractor identification and technical specifications

## 2-10 Hydraulic circuit specifications

### PUMP

Type	Double gear type (in tandem)
Make	Bosch.
Model	A - 510 - 845 - 262
Pump / engine RPM ratio	1: 1.25
Max. operating pressure	180 $\pm$ 5 bar
Max. flow at engine rate	39 l/min MF 2210 / 54 l/min MF 2225 - 2235
Max. flow at engine rate	39 l/min MF 2210 / 54 l/min MF 2225 - 2235
Position	at side of engine
Drive	Timing system gears
Quantity of hydraulic oil / transmission	35 l.
Type of oil	transfluid AS/B.

### FILTERS

Type (on the intake)	With single washable metal gauze cartridge
filtering degree	40 micron
Type (on the delivery)	with single replaceable paper cartridge
filtering degree	15/20 micron

### STEERING SYSTEM

System	Power steering system
Make	Danfoss
Type	Orbitrol ospc 70 4 W.D. Orbitrol ospc 50 2 W.D.
4 WD nominal cylinder	70 cc. per rev.
2 WD nominal cylinder	50 cc. per rev.

Calibrating valve	155 $\pm$ 5 (built into the valve system block)
Antishock valve calibration	205 bar (built into the valve system block)

Steering cylinder	Quantity 1
Type	double-acting, balanced
Make	Massey Ferguson
dimensions	32 x 48 x 242 /2 mm.
pump delivery	27.3 l. / min. at 2600 RPM engine rate
steering wheel turns	2 turns to the right
steering wheel turns	1.75 turns to the left
steering wheel diameter	360 mm.

### HYDRAULIC POWER PACK

Make	Comatrol
Type	Electrohydraulic
Low pressure calibrating valve	18 bar
Cooling circuit calibrating valve	5 bar
Compensating valve	Modular
Forced lubrication valve	1.5 bar
Oil outlet towards the transmission	Spray lubrication
Uses	BLc - PTO/FRn - STR - DTi
Type of engagement	Electrohydraulic



# Tractor identification and technical specifications

## AUXILIARY CONTROL VALVES

Make	SLX
Operation	Standard-Single / double acting, hydraulic, with "Kick out" automatic release
Type	Open center with "Push - Pull" quick couplings
Calibrating valve	180 $\pm$ <sub>0</sub> <sup>5</sup> bar
Max. flow rate	35 l. / min.
Max. quantity	3 elements
Connection to circuit	in series
Position	at rear

## HYDRAULIC MECHANICAL POWER LIFT

Make	Mita / Massey Ferguson
Operating mode	position / draft control intermix - float mode lowering adjustment
Hydraulic system	with open-center
Standard cylinder	single-acting
Dimensions	ø 90 x 116 stroke
Supplementary cylinders	2 single-acting types
dimensions	ø 40 x 220 stroke
Calibrating valve	180 $\pm$ <sub>0</sub> <sup>5</sup> bar
Antishock valve	200 $\pm$ <sub>0</sub> <sup>5</sup> bar

## LIFTING CAPACITY

Standard	2100 Kg.
With 2 supplementary cylinders	3400 Kg.
lower links	Class 1 and 2
third point	with hydraulic ram (optional)

**<https://www.ebooklibonline.com>**

Hello dear friend!

Thank you very much for reading.

Enter the link into your browser.

The full manual is available for immediate download.

**<https://www.ebooklibonline.com>**