

Service Manual

MF1746 / 1756

Round Baler



VISION INNOVATION LEADERSHIP QUALITY RELIABILITY SUPPORT PRIDE COMMITMENT



MASSEY FERGUSON

Massey Ferguson®

1746 / 1756
Round Baler

SERVICE MANUAL 4283381M2

CONTENTS

GENERAL INFORMATION	01
DRIVES.....	02
PICKUP.....	03
ELECTRICAL	04
BALE FORMING	05
BALE WRAPPING.....	06
MAINFRAME AND WHEELS	07
HYDRAULICS	08
INDEX	09

NOTES

<https://www.ebooklibonline.com>

Hello dear friend!

Thank you very much for reading.

Enter the link into your browser.

The full manual is available for immediate download.

<https://www.ebooklibonline.com>

Massey Ferguson®

1746 / 1756
Round Baler

SERVICE MANUAL
4283381M2

01 - General Information

Contents

Introduction	01-3
Units of Measurement	01-3
Replacement Parts	01-3
Serial Number Plate Location	01-3
Machine Identification	01-3
Baler Operation	01-4
Tailgate Lockout Valve	01-5
Baler Components	01-6
Forming Belts Warranty	01-11
Safety	01-13
Safety Alert Symbol	01-13
Safety Signs	01-13
Safety Messages	01-13
Informational Messages	01-13
Operator Manual	01-14
A Word to the Operator	01-14
Prepare for Operation	01-14
Operation	01-15
Travel On Public Roads	01-17
Fire Prevention	01-18
Maintenance	01-18
Tire Safety	01-20
Specifications	01-21
4 X 6 Baler	01-21
5 X 6 Baler	01-24
Lubrication	01-27
Service Chart	01-27
Roller Chains	01-27
Gearbox	01-29
Grease Fittings	01-30
Sealed Bearings	01-33
Wheel Bearings	01-33
General Maintenance Information	01-33
General Service Procedures	01-33
Bolt Torque Values	01-33
Wheel Hardware	01-35
Bearing Replacement (Eccentric Self-Locking Collar)	01-36
Gib Key Removal And Installation	01-37

GENERAL INFORMATION

INTRODUCTION

The operation and maintenance instructions included in this manual are assembled from field testing and other data. The information is written for general conditions. Make adjustments as necessary for specific conditions.

Right-hand and left-hand, as used in this manual, is determined by facing the direction the machine will travel when in use.

Units of Measurement

Measurements are given in metric units of measurement followed by the equivalent in U.S. units. Hardware sizes are given in millimeters for metric hardware and inches for U.S. hardware.

Replacement Parts

To receive prompt efficient service, always remember to give the dealer the following information:

- Correct part description or part number.
- Model number of your machine.
- Serial number of your machine.

Serial Number Plate Location

FIG. 1: The serial number plate (1) is located on the inside of the left-hand side panel.

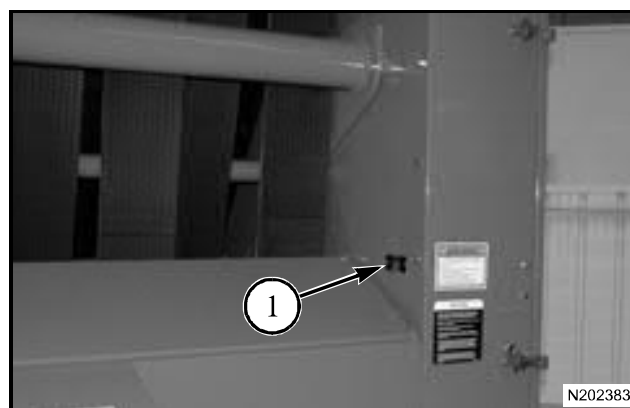

FIG. 1

Machine Identification

Machine Model No.: _____

Machine Serial No.: _____

Date of Delivery: _____

Dealer Name and Address: _____

Dealer's Telephone No.: _____

General Information

Dealer's Fax No.: _____

Baler Operation

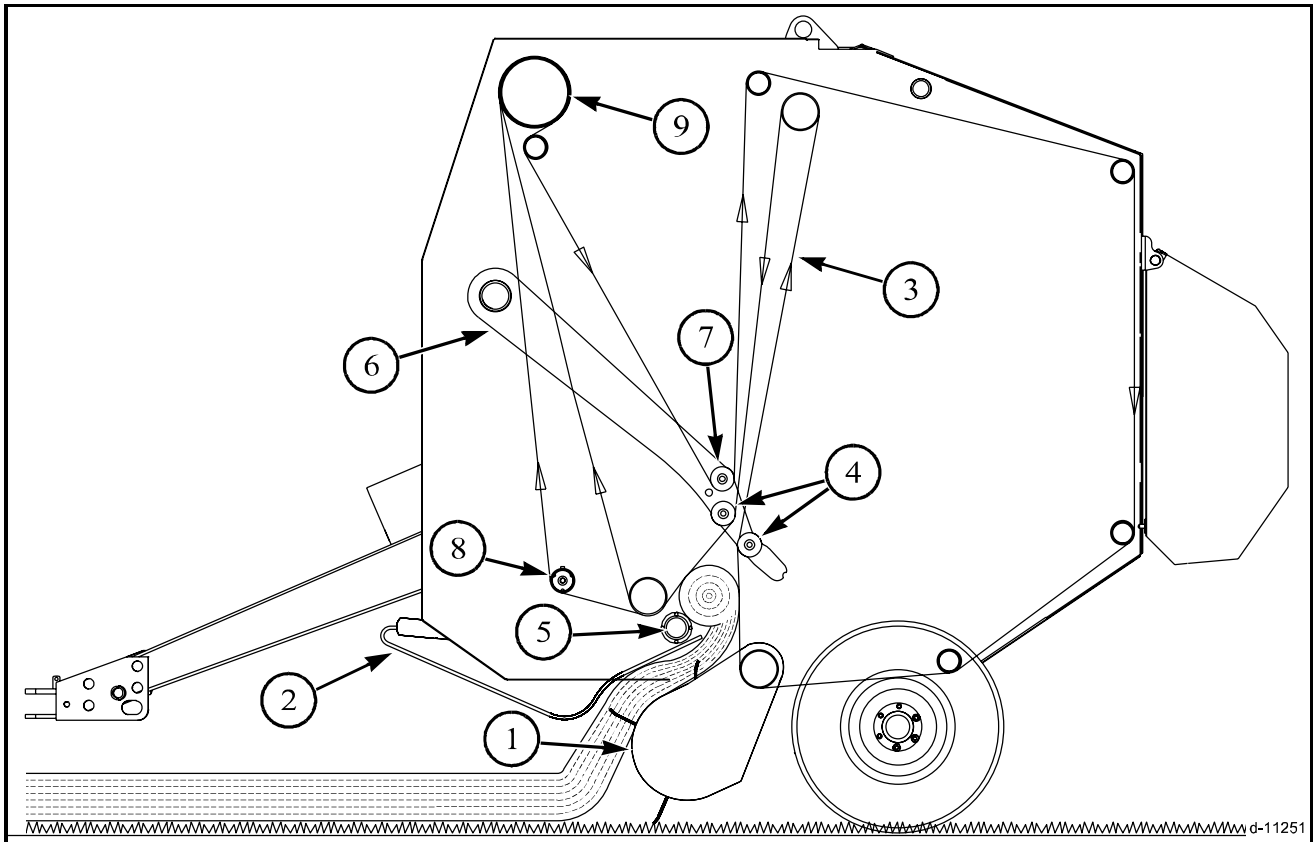

FIG. 2

FIG. 2: The illustration shows the windrowed crop being picked up. The crop moves across the pickup assembly (1) into the bottom of the open throat bale chamber. The windguard (2) holds the crop against the pickup assembly. In the bale chamber the crop contacts the rough top surface of the forming belts (3), which are moving upward. The forming belts carry the crop to the top of the starting chamber which is formed by the bale density rolls (4). The downward motion of the forming belts turns the crop downward against the starting roll (5). The starting roll folds the crop rearward into the crop coming in. The core is started and begins to roll.

Springs and hydraulic cylinders pull down on the tension arms (6). The bale density rolls are held down to reduce the size of the bale chamber to a starting size. The belt tension roll (7) is held down to remove the slack from the forming belts. As the bale increases in size, the bale density rolls are forced upward moving the bale size indicator downward. The bale density rolls put an increasing downward force against the bale. This force keeps tension on the bale and compresses the crop coming into the baler.

The stagger roll (8) holds some forming belts in front of the other forming belts. This releases crop deposits from behind the forming belts.

The forming belts are driven by the drive roll (9).

FIG. 3: The illustration shows the full size bale. The bale density rolls (1) have moved upward, to increase the size of the bale chamber. The bale is on the tailgate carrier roll (2).

The bale must now be wrapped and unloaded.

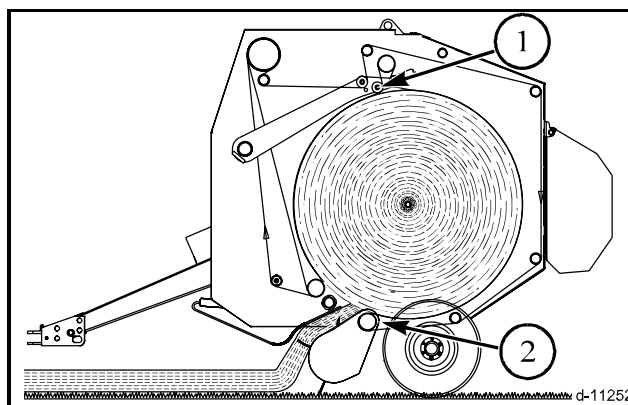

FIG. 3

Tailgate Lockout Valve

FIG. 4: When the tailgate is raised for any maintenance or service work, push the lockout valve (1) into the LOCKED position to prevent the tailgate from being lowered. The tailgate can only be lowered when the tailgate lockout valve is released (pulled out).

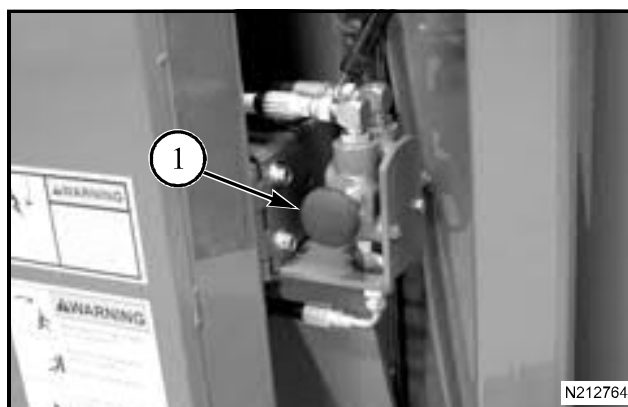

FIG. 4

General Information

Baler Components

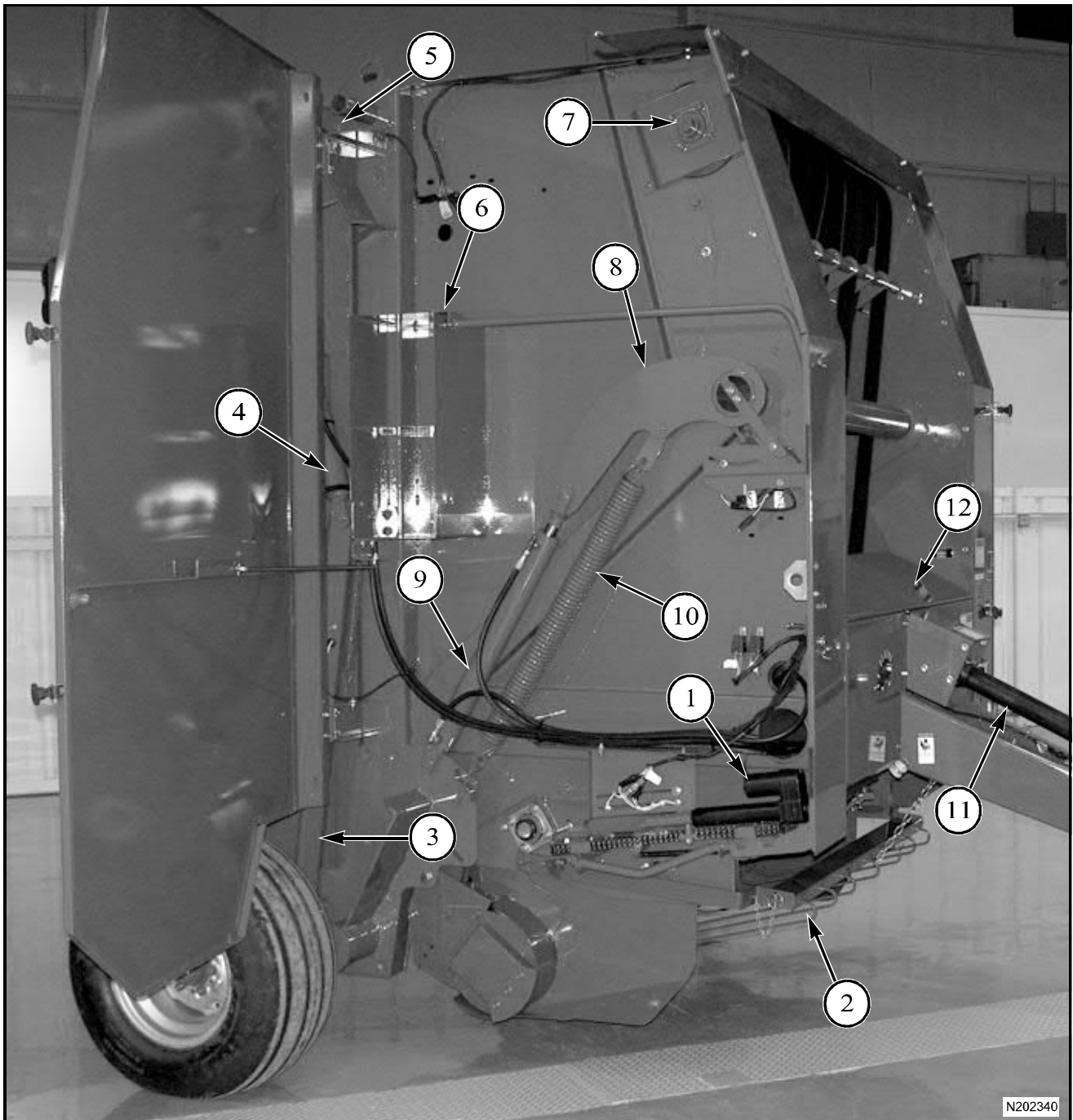

FIG. 5

Right-hand side of the baler.

- | | |
|---------------------------------|---------------------------------------|
| (1) Twine arm actuator | (7) Drive roll shaft |
| (2) Windguard | (8) Forming belts tensioning arm |
| (3) Tailgate latch strap | (9) Forming belts tensioning cylinder |
| (4) Tailgate hydraulic cylinder | (10) Forming belts tensioning spring |
| (5) Tailgate hinge pivot point | (11) Implement driveline |
| (6) Right-hand twine box | (12) Slip clutch (Located under lid) |

Tailgate

FIG. 5: The tailgate is the rear half section of the bale chamber and is supported by a hinge that is at the top. The tailgate is operated by two hydraulic cylinders to unload the bale. The tailgate has forming belt idler rolls and a bale carrier roll.

When the tailgate closes, the hydraulic cylinder must be completely retracted in to latch the tailgate. If the tailgate is not latched, the tailgate will swing open as the core is started and the core will stop rolling. The bale must be unloaded. The tailgate hydraulic cylinders are connected to linkage that releases the latches when the tailgate is opened.

Pickup Assembly

FIG. 6: The pickup assembly (1) picks up and feeds the hay into the bale chamber. The major components of the pickup assembly are the rotor shaft, tine bars, cam track, windguard, and the pickup height control crank.

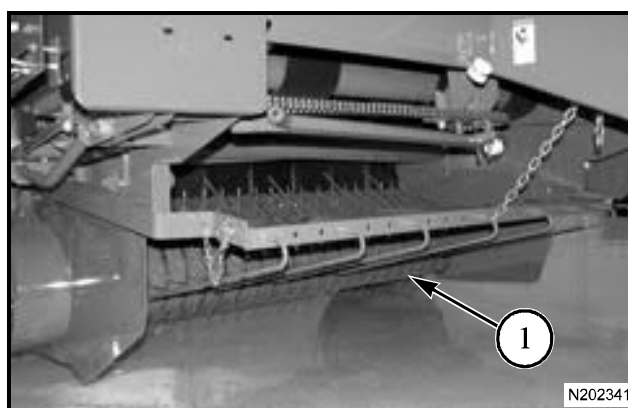

FIG. 6

Forming Belts

FIG. 7: The forming belts (1) are made of a high tensile strength, controlled stretch, synthetic fabric bonded to the covering material. The surface pattern on the forming belts helps to roll the bale. See the Specifications section for more information on the forming belts.

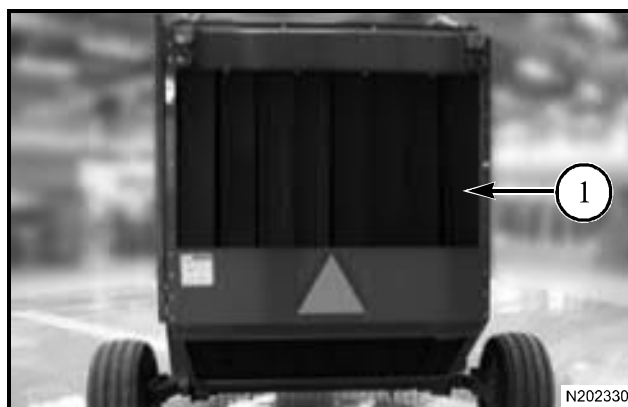

FIG. 7

General Information

Bale Density System

FIG. 8: The bale density is controlled by two springs (1) and a hydraulic tension system. As the bale increases in size, oil is forced from the rod end of the forming belts tensioning cylinder (2) through a non-adjustable relief valve (3) to the base end.

The pressure in the hydraulic tension system is held at 13 790 kPa (2000 psi) for the 4x6 baler or at 16 547 kPa (2400 psi) for the 5x6 baler.

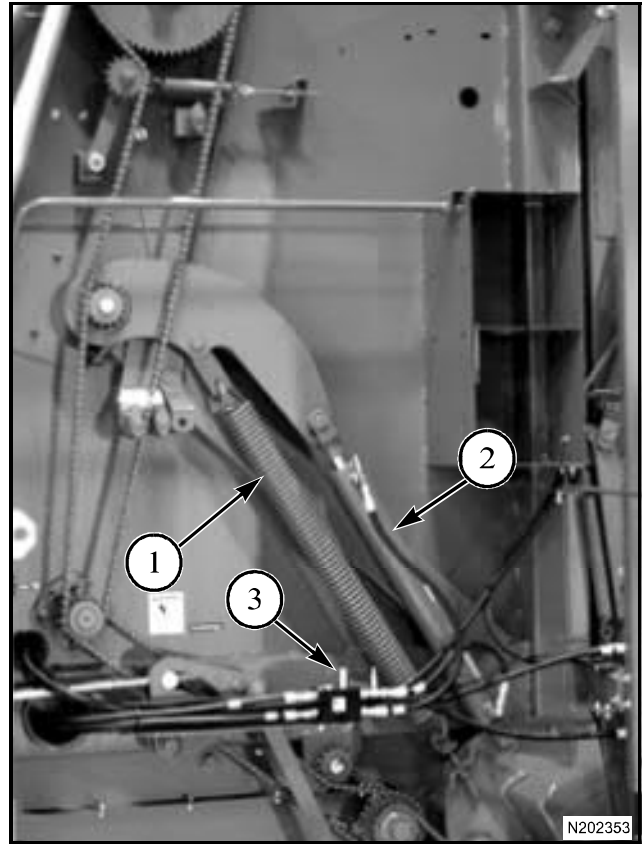

FIG. 8

Bale Size Indication

FIG. 9: The bale size indicator (1) is located on the front right-hand side of the baler. As the bale increases in size, the bale size indicator pointer will move down. Begin wrapping the bale immediately when the bale has reached the desired size.

The bale size indicator must be checked for accuracy for each tractor used. See the Adjustments section.

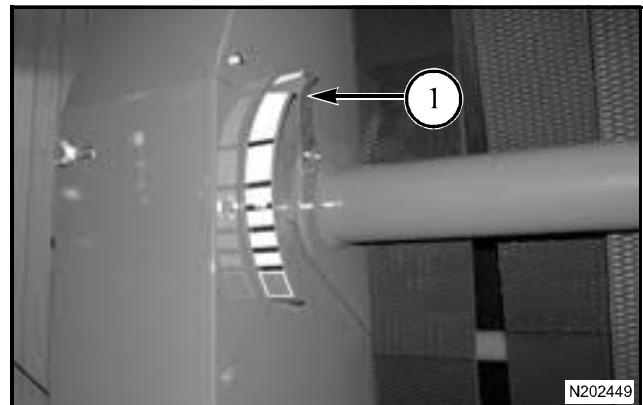

FIG. 9

Lighting and Reflectors

FIG. 10: The baler is equipped with a lighting and marking system. The lighting system includes the lighting wiring harness, seven pin SAE connector and the warning lamps (1). The marking system includes yellow front reflectors, red rear reflectors (2) and the SMV (slow moving vehicle) emblem (3) mounted on the back of the tailgate.

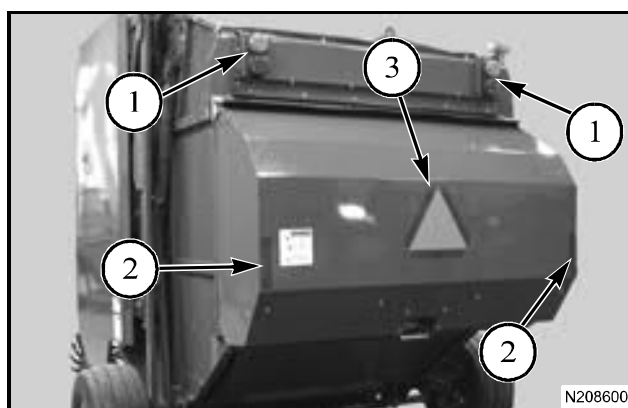

FIG. 10

Main Drive Slip Clutch

FIG. 11: The radial pin clutch (1) on the output shaft of the gearbox gives overload protection for all mechanical components.

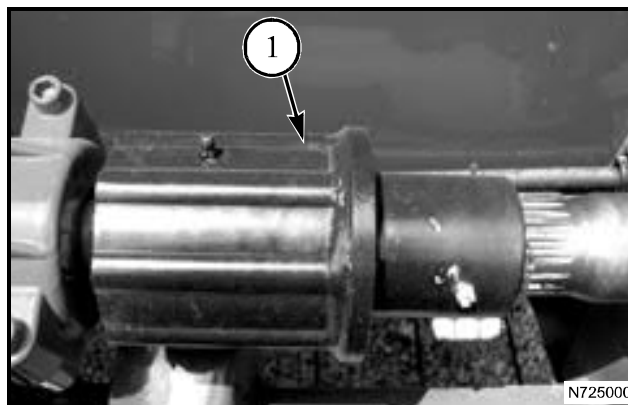

FIG. 11

Hydraulic System

Two hydraulic hoses connect to the tractor remote hydraulic system outlets for the tailgate cylinders. The hydraulic system requires tractor hydraulic pressure of 12 410 kPa (1800 psi) and a flow of 30 to 38 l/min (8 to 10 gal/min).

Twine System

The bales are wrapped with twine when the desired size is reached. The twine boxes are located behind the side doors of the baler. Each twine box holds two balls of twine for a total of four balls. The twine feeds through the twine tubes then between the twine tension plates, through the front shields and down to the twine arm and the main twine tensioning spring plates within the twine arm. The arm is controlled by an electrically controlled actuator.

General Information

Mesh Wrap System (Optional)

FIG. 12: The baler is available with an optional mesh wrap system (1) in addition to the twine system. The mesh wrap assembly is mounted on the rear of the baler.

The operator selects either twine or mesh wrap from the tractor using the console.

An electric actuator is used to engage and disengage the mesh wrap system. The operator controls the mesh wrap system from the tractor using the console.

See the Operation section for more details. The mesh wrap is driven by the forming belts.



FIG. 12

Control Console

FIG. 13: The control console contains the following:

- (1) Power switch
- (2) Drive left lamp
- (3) Drive lamp
- (4) Drive right lamp
- (5) Kicker switch
- (6) Twine/Mesh Wraps knob
- (7) Mesh Feed lamp
- (8) Auto Tie switch
- (9) Twine/Mesh Manual Control switch

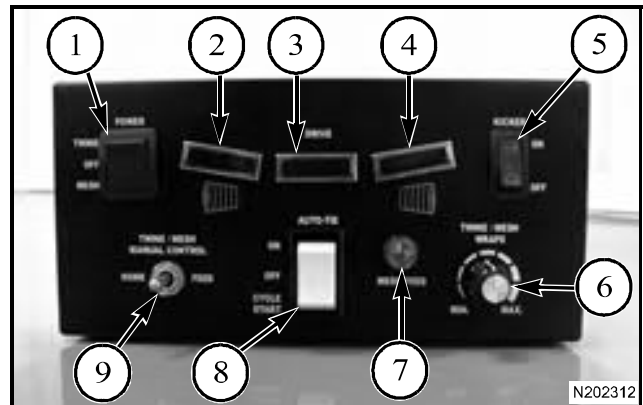

FIG. 13

Forming Belts Warranty

Forming Belts Eligible for Warranty Replacement

FIG. 14: Belts are warrantable if the material and/or workmanship is defective and the machine is under warranty. Ply separation is warrantable within the warranty period of the machine.



FIG. 14

Forming Belts Not Eligible for Warranty Replacement

FIG. 15: Slight fraying of the edges is a normal condition, and does not indicate a defective belt. Frayed edges are not a warrantable failure.

Wear on the back side of the forming belt indicates rubbing against the baler side wall or components. This does not indicate a defective belt, and is not warrantable. Adjustments must be made to correct belt tracking to avoid further wearing or curling of the belt.



FIG. 15

FIG. 16: Belts that are cut and/or torn in two are not considered a warranted failure.

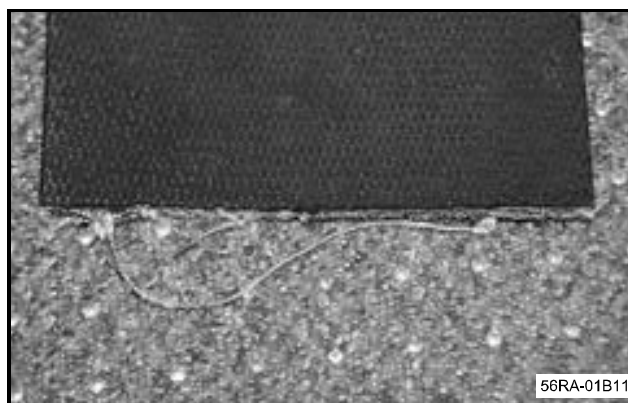

FIG. 16

General Information

FIG. 17: Belts with holes and/or tears are not considered a warranted failure.



FIG. 17

FIG. 18: Belts with tears are not considered a warranted failure.

Forming belts damaged by accumulation of crop and/or foreign objects are not eligible for warranty replacement.

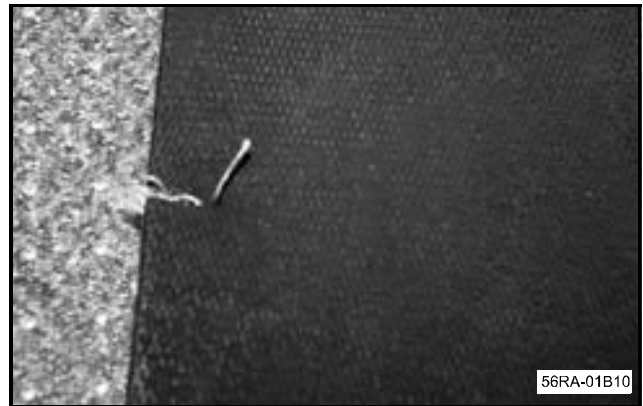

FIG. 18



Suggest:

For more complete manuals. Please go to the home page.

<https://www.ebooklibonline.com>

If the above button click is invalid. Please download this document first, and then click the above link to download the complete manual.

Thank you so much for reading

SAFETY

Safety Alert Symbol

FIG. 19: The safety alert symbol means ATTENTION! BECOME ALERT! YOUR SAFETY IS INVOLVED!

This safety alert symbol indicates important safety messages in this Operator Manual. When you see this symbol, carefully read the message that follows and be alert to the possibility of personal injury or death.

Safety Signs

If a used machine has been purchased, be sure that all safety signs are in the correct location and can be read.

Replace any safety signs that can not be read or are missing. Replacement safety signs are available from your dealer. The location of safety signs is illustrated at the end of this section.

Safety Messages

FIG. 20: Whenever you see the words and symbols shown below, used in this manual, you MUST take note of their instructions as they relate to personal safety.

 **DANGER:** Indicates an imminently hazardous situation that, if not avoided, will cause death or very serious injury.

 **WARNING:** Indicates a potentially hazardous situation that, if not avoided, could result in death or serious injury.

 **CAUTION:** Indicates a potentially hazardous situation that, if not avoided, may result in minor injury.



FIG. 19



FIG. 20

Informational Messages

The words IMPORTANT and NOTE are not related to personal safety, but are used to give additional information and tips for operating or servicing this equipment.

IMPORTANT: Identifies special instructions or procedures which, if not strictly observed, could result in damage to or destruction of the machine, process, or its surroundings.

NOTE: Identifies points of particular interest for more efficient and convenient repair or operation.

General Information

Operator Manual

The photos, illustrations, and data used in this manual were current at the time of printing, but due to possible in-line production changes, your machine can vary slightly in detail. The manufacturer reserves the right to redesign and change the machine as necessary without notification.



WARNING: In some of the illustrations or photos used in this manual, panels or guards may have been removed for clarity. Never operate the machine with any panels or guards removed. If the removal of panels or guards is necessary to make a repair, they **MUST** be replaced before operation.

A Word to the Operator

FIG. 21: It is **YOUR** responsibility to read and understand the Safety section in this book before operating this machine. Remember that **YOU** are the key to safety. Good safety practices not only protect you, but also the people around you. Study the features in this book and make them a working part of your safety program. Keep in mind that this Safety section is written only for this type of machine. Practice all other usual and customary safe working precautions, and above all **REMEMBER - SAFETY IS YOUR RESPONSIBILITY. YOU CAN PREVENT SERIOUS INJURY OR DEATH.**

This Safety section is intended to point out some of the basic safety situations that may be encountered during the normal operation and maintenance of your machine, and to suggest possible ways of dealing with these situations. This section is **NOT** a replacement for other safety practices featured in other sections of this book.

IMPORTANT: *This manual covers general safety practices for this machine. It must always be kept with the machine.*



WARNING: An operator should not use alcohol or drugs which can affect their alertness or coordination. An operator on prescription or 'over the counter' drugs needs medical advice on whether or not they can properly operate machines.

Prepare for Operation

Read this manual completely and make sure you understand the controls. Know the positions and operations of **all** controls before you operate this machine. Check all controls in an area clear of people and obstacles before starting your work.

All equipment has a limit. Make sure you understand the speed, brakes, steering, stability, and load characteristics of this machine before you start.

Make sure your machine has the correct equipment needed by the local regulations.

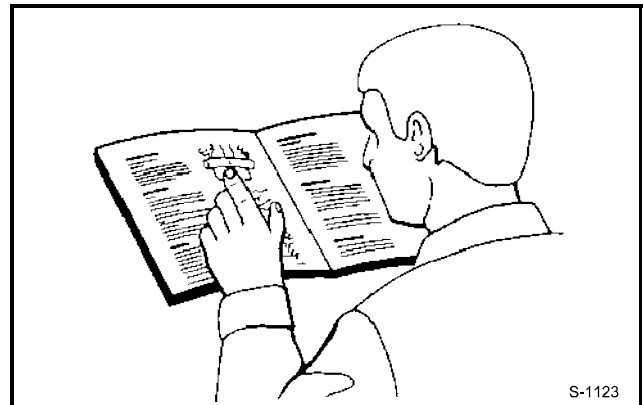

FIG. 21

<https://www.ebooklibonline.com>

Hello dear friend!

Thank you very much for reading.

Enter the link into your browser.

The full manual is available for immediate download.

<https://www.ebooklibonline.com>