

Service Manual

MF1734

Round Baler



VISION INNOVATION LEADERSHIP QUALITY RELIABILITY SUPPORT PRIDE COMMITMENT



MASSEY FERGUSON

Massey Ferguson®

1734 Round Baler

SERVICE MANUAL 4283412M1

CONTENTS

GENERAL INFORMATION	01
DRIVES.....	02
PICKUP.....	03
ELECTRICAL	04
BALE FORMING	05
BALE WRAPPING.....	06
CHASSIS	07
HYDRAULICS	08
INDEX	09

NOTES

<https://www.ebooklibonline.com>

Hello dear friend!

Thank you very much for reading.

Enter the link into your browser.

The full manual is available for immediate download.

<https://www.ebooklibonline.com>

Massey Ferguson®

1734
Round Baler

WORKSHOP SERVICE MANUAL
4283412M1

01 - General Information

Contents

Introduction	01-3
Units of Measurement	01-3
Replacement Parts	01-3
Serial Number Plate Location	01-3
Machine Identification	01-3
Baler Operation	01-4
Tailgate Cylinder Stops	01-5
Baler Components	01-6
Tailgate	01-7
Pickup Assembly	01-7
Bale Oversize Protection	01-7
Forming Belts	01-7
Bale Size Indication	01-8
Bale Full Audible Alert	01-8
Drive System	01-9
Hydraulic System	01-9
Twine System	01-9
Safety Alert Symbol	01-10
Safety Messages	01-10
Informational Messages	01-10
Safety Signs	01-11
A Word To The Operator	01-11
Operator Manual	01-12
Prepare For Operation	01-13
Operation	01-14
General Information	01-14
PPE (Personal Protection Equipment)	01-15
Seat Instructions	01-16
Shield and Guards	01-16
Exhaust Warning	01-17
Flying Debris	01-17
Agricultural Chemicals	01-17
Travel On Public Roads	01-18
Roller Chains	01-19
Grease Fittings	01-21
Gearbox	01-23
Maintenance	01-23
General Information	01-23
Fire Prevention and First Aid	01-25
Checking for High Pressure Leaks	01-26
Tire Safety	01-26
Dimensions and Weights	01-27
Bale Size	01-27

Contents

Bale Chamber	01-27
Tires	01-27
Drives	01-28
Pickup	01-28
Bale Wrapping Mechanism	01-28
Tractor Requirements	01-28
Lubrication	01-28
General Service Procedures	01-29
Bolt Torque Values	01-29
Wheel Hardware	01-30
Bearing Replacement (Eccentric Self-Locking Collar)	01-30
Gib Key Removal And Installation	01-31

GENERAL INFORMATION

INTRODUCTION

The operation and maintenance instructions included in this manual are assembled from field testing and other data. The information is written for general conditions. Make adjustments as necessary for specific conditions.

Right-hand and left-hand, as used in this manual, is determined by facing the direction the machine will travel when in use.

Units of Measurement

Measurements are given in metric units of measurement followed by the equivalent in U.S. units. Hardware sizes are given in millimeters for metric hardware and inches for U.S. hardware.

Replacement Parts

To receive prompt efficient service, always remember to give the dealer the following information:

- Correct part description or part number.
- Model number of your machine.
- Serial number of your machine.

Serial Number Plate Location

FIG. 1: The serial number plate (1) is located on the inside of the left-hand side panel.

Machine Identification

Machine Model No.: _____

Machine Serial No.: _____

Date of Delivery: _____

Dealer Name and Address: _____

Dealer's Telephone No.: _____

Dealer's Fax No.: _____

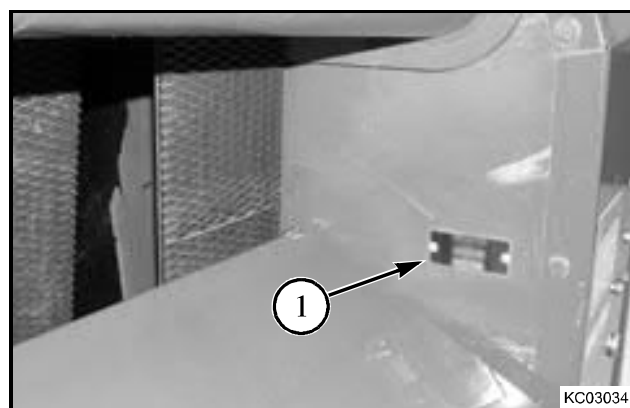

FIG. 1

General Information

Baler Operation

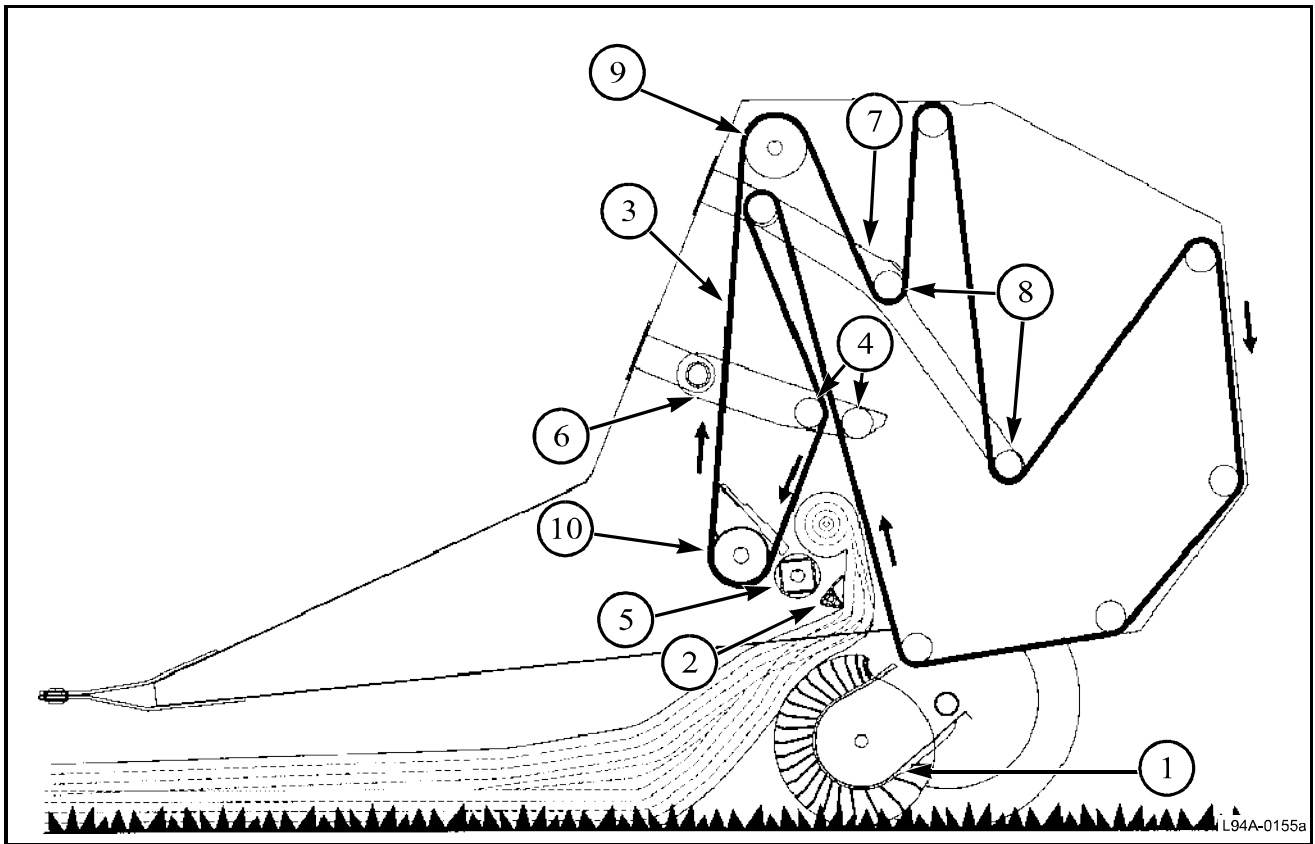

FIG. 2

FIG. 2: The illustration shows the windrowed crop being picked up. The crop moves across the pickup assembly (1) into the bottom of the open throat bale chamber. The crop rotates the filler plate (2) so the size of the throat opening is increased. In the bale chamber the crop contacts the rough top surface of the forming belts (3) which are moving upward. The forming belts carry the crop to the top of the starting chamber which is formed by the bale density rolls (4). The downward motion of the forming belts turn the crop downward against the starting roll (5). The starting roll folds the crop rearward into the crop coming in. The core is started and begins to roll. The rolling crop rotates the filler plate down so the filler plate helps support the core.

Springs pull down on the bale density arms (6) for the bale density rolls and the belt tension (7) arms for the belt tension rolls (8). The bale density rolls are held down to hold the size of the bale chamber to a starting size. The belt tension rolls are held down to remove the slack from the forming belts. As the bale increases in size, the bale density rolls and the belt tension rolls are forced upward. The bale density rolls put an increasing downward force against the bale. This force keeps tension on the bale and compresses the crop coming into the bale. The tensioning rolls move upward to give more forming belt for the increased size of the bale chamber. The bale tensioning rolls keep constant pressure on the forming belts.

The belts are driven by the upper drive roll (9) and the lower drive roll (10).

FIG. 3: The illustration shows the bale that is almost finished. The belt tensioning rolls have moved upward, to increase the size of the bale chamber.

The bale is being supported by the carrier roll, the tailgate carrier roll (1), the filler plate, and the forming belts.

The bale must now be wrapped with twine and unloaded.

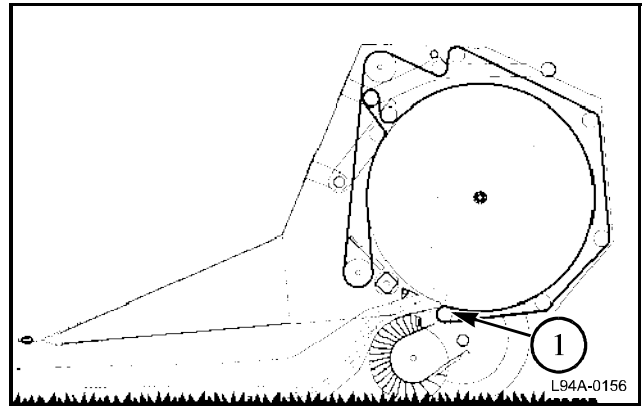

FIG. 3

Tailgate Cylinder Stops

FIG. 4: When the tailgate is raised for any maintenance or service work, install both tailgate cylinder stops (1) to prevent the tailgate from being lowered. The tailgate can only be lowered when the tailgate cylinder stops are removed.

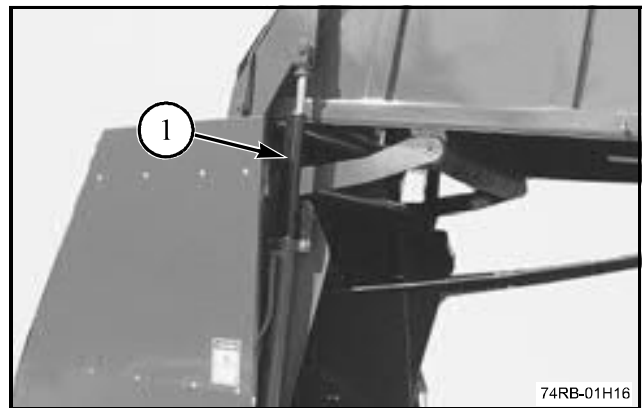

FIG. 4

FIG. 5: Make sure both tailgate cylinder stops are removed and in the storage position (1) before lowering the tailgate. Lowering the tailgate with one tailgate cylinder stop installed can twist the tailgate frame and cause belt tracking problems.

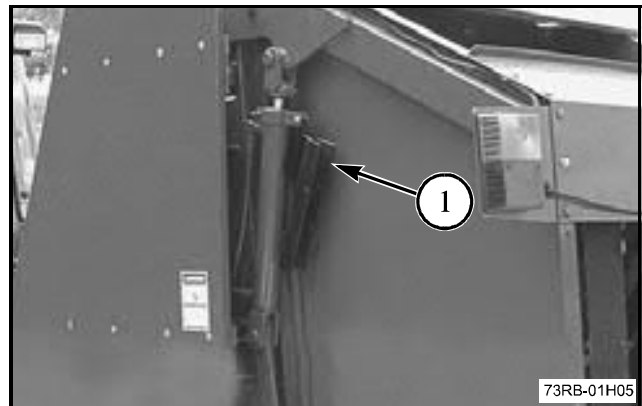

FIG. 5

General Information

BALER COMPONENTS

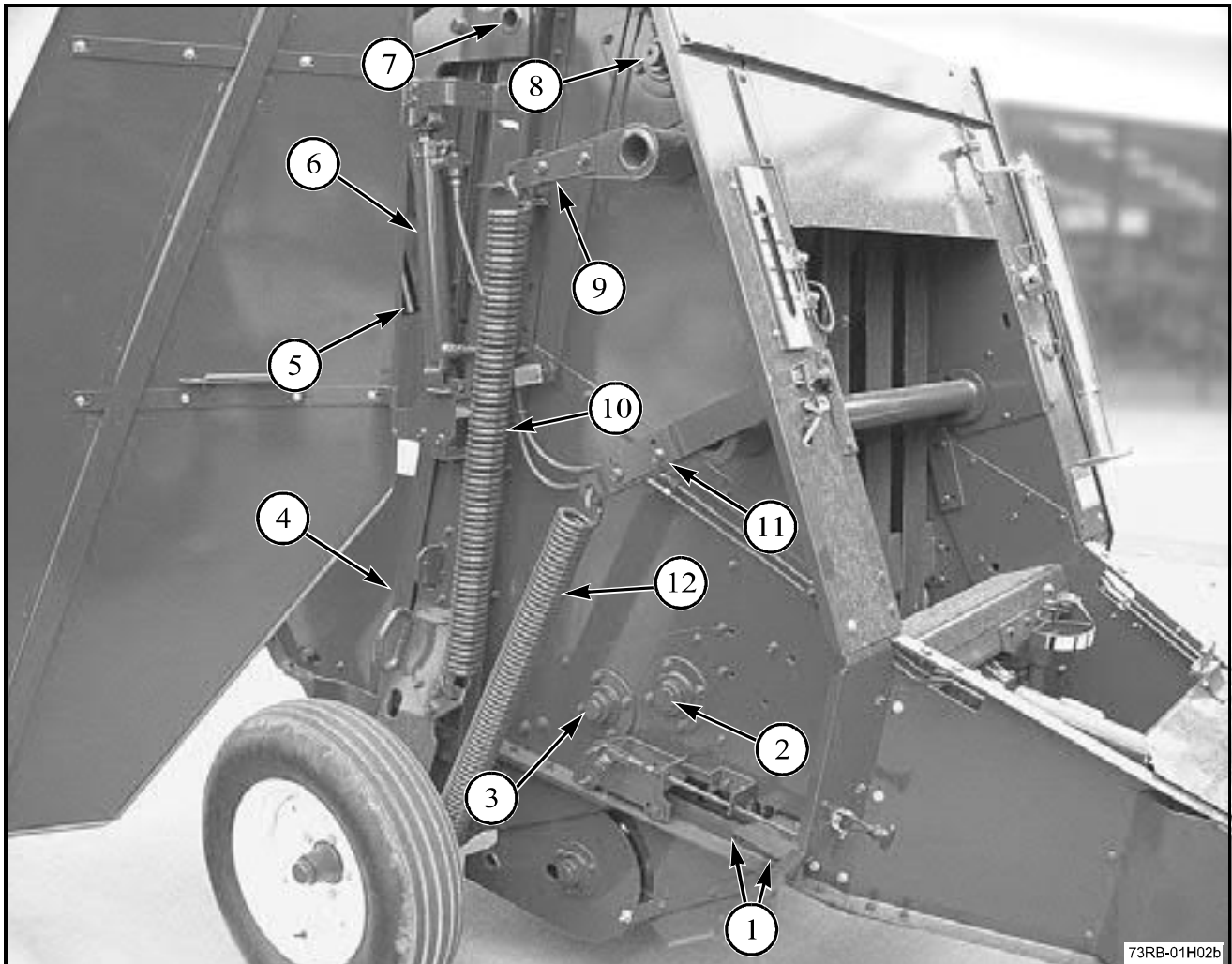

FIG. 6

FIG. 6: Right-hand side of the baler.

- (1) Twine Arm End Tubes
- (2) Lower Drive Roll Shaft
- (3) Starting Roll Shaft
- (4) Tailgate Latch Strap
- (5) Tailgate Cylinder Stop
- (6) Tailgate Hydraulic Cylinder
- (7) Tailgate Hinge Pivot Point
- (8) Upper Drive Roll Shaft
- (9) Forming Belts Tensioning Arm
- (10) Forming Belts Tensioning Spring
- (11) Bale Density Arm
- (12) Bale Density Arm Spring

Tailgate

FIG. 7: The tailgate is the rear half section of the bale chamber and is supported by a hinge at the top. The tailgate is operated by two hydraulic cylinders to unload the bale. The tailgate has three forming belt idler rolls and at the bottom, a bale carrier roll.

The tailgate hydraulic cylinders are connected to linkage that releases the latches when the tailgate is opened. When closed, the tailgate is latched to the mainframe. This latch must be engaged when making the bale. If the tailgate is not latched, the tailgate will swing open as the core is started and the core will stop rolling. The bale must be unloaded. When the tailgate closes, the hydraulic cylinder must be completely retracted in order to latch the tailgate.

An indicator rod (1) operated by the right-hand hydraulic cylinder will move out of view at the top of the machine to indicate that the tailgate is closed and latched.

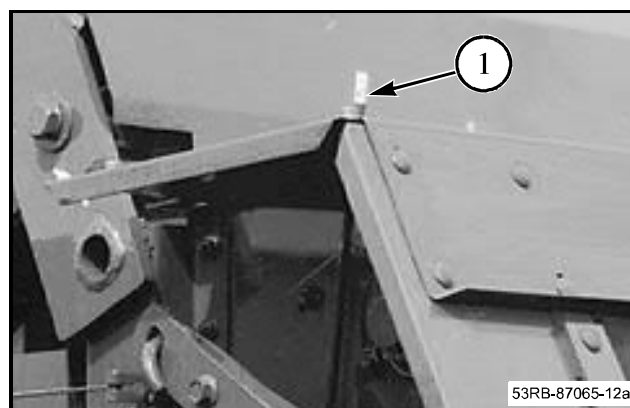

FIG. 7

Pickup Assembly

FIG. 8: The pickup (1) is belt driven and has three tine bars, each bar having tines for clean crop pickup. See the Specifications section for the number of tines. The tines extend when entering the windrow. The tines retract from the crop as the crop is fed into the throat of the bale chamber. Operate the pickup just high enough so the tines will clear the ground. The pickup drive belt (2) has a spring loaded tensioner (3) to hold proper belt tension.

Bale Oversize Protection

Overfill protection is given by declutching the pickup drive, using a declutcher rod (4) connected between the forming belts tension arm and the pickup drive belt tensioner arm. The declutcher is used to prevent damage to the machine from filling too full because of operator error or machine malfunction.

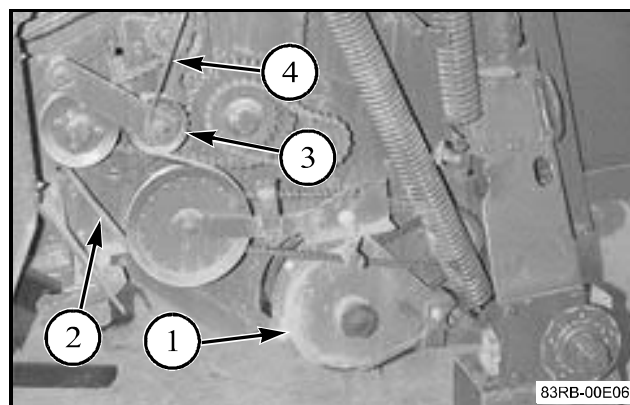

FIG. 8

Forming Belts

FIG. 9: The forming belts (1) are made of a high tensile strength, controlled stretch, synthetic fabric bonded to the covering material. The ends of the forming belts are joined with lacing pins. See the Specifications section for more information on the forming belts.



FIG. 9

General Information

Bale Size Indication

FIG. 10: A gauge (1) on the right-hand side of the machine has reference marks to use in determining bale size. An indicator or pointer connected to the right-hand bale density torque arm moves downward under the gauge as the bale increases in size. The marks are for reference only and do not indicate the exact bale size. To know the relationship of the diameter of the bale to the bale size gauge, stop and measure as the indicator reaches the reference marks while building the first bale.

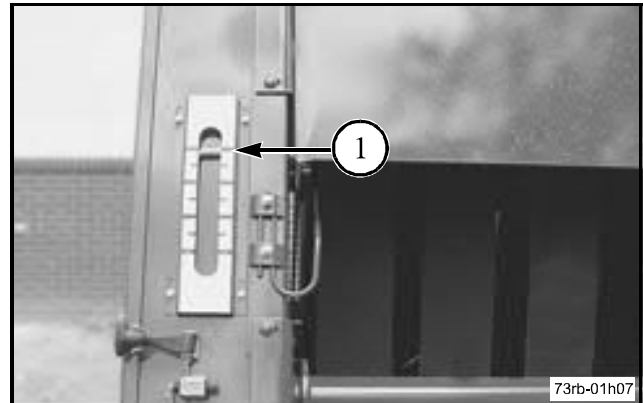

FIG. 10

Bale Full Audible Alert

FIG. 11: The baler is equipped with a mechanical audible alert mechanism (1) that tells the operator when the bale has reached full size and is ready to be wrapped. The audible alert rod contacts the sprocket (2) that is connected to the right-hand end of the front bale density roll. The audible alert mechanism makes a sharp intermittent sound which is easily heard. The operator must begin the wrapping procedure as soon as the audible alert sounds. The audible alert will continue to sound until the bale is discharged from the bale chamber.

If the operator continues to fill the bale chamber after the audible alert sounds, the idler is lifted off the pickup drive belt by the clutch rod to disengage the pickup assembly, which stops the feeding of the baler.

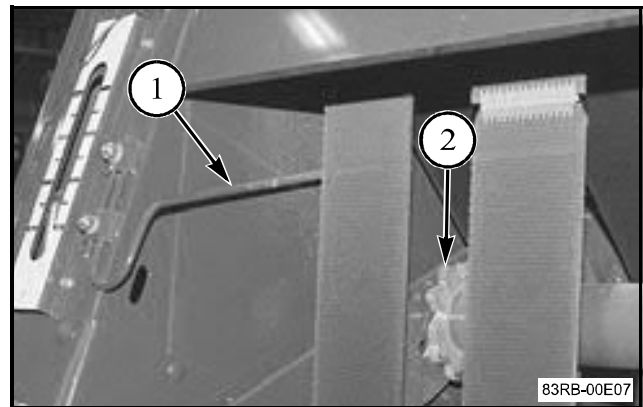

FIG. 11

General Information

FIG. 14: The twine knife is actuated through the pull rod (1) by the twine arm (2) when the twine arm returns the home position.

There is one twine guide rod mounted inside of the right-hand side of the baler to put the twine properly on the right-hand end of the bale. Limit of arm travel to the left-hand side of the baler puts twine properly on the left-hand end of the bale. See the Operation section for twine threading.

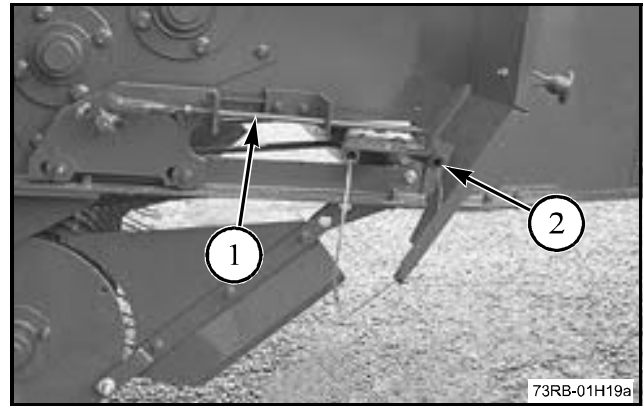

FIG. 14

SAFETY ALERT SYMBOL

FIG. 15: The safety alert symbol means ATTENTION! BECOME ALERT! YOUR SAFETY IS INVOLVED!

Look for the safety alert symbol both in this manual and on safety signs on this machine. The safety alert symbol will direct your attention to information that involves your safety and the safety of others.

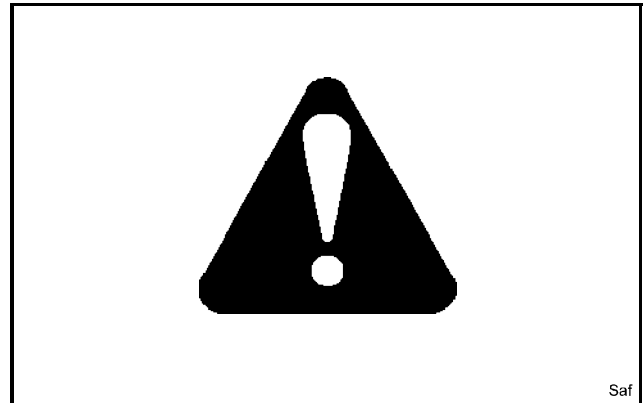



FIG. 15

SAFETY MESSAGES

FIG. 16: The words DANGER, WARNING or CAUTION are used with the safety alert symbol. Learn to recognize these safety alerts and follow the recommended precautions and safety practices.

 **DANGER:** Indicates an imminently hazardous situation that, if not avoided, will result in DEATH OR VERY SERIOUS INJURY.

 **WARNING:** Indicates a potentially hazardous situation that, if not avoided, could result in DEATH OR SERIOUS INJURY.

 **CAUTION:** Indicates a potentially hazardous situation that, if not avoided, may result in MINOR INJURY.



FIG. 16

INFORMATIONAL MESSAGES

The words IMPORTANT and NOTE are not related to personal safety, but are used to give additional information and tips for operating or servicing this equipment.

IMPORTANT: Identifies special instructions or procedures which, if not strictly observed, could result in damage to or destruction of the machine, process, or its surroundings.

NOTE: Identifies points of particular interest for more efficient and convenient repair or operation.

SAFETY SIGNS



WARNING: DO NOT remove or obscure Danger, Warning or Caution signs. Replace any Danger, Warning or Caution signs that are not readable or are missing. Replacement signs are available from your dealer in the event of loss or damage. The actual location of the safety signs is illustrated at the end of this section.

Keep signs clean by wiping off regularly. Use a cleaning solution if necessary.

If parts have been replaced or a used machine has been purchased, make sure all safety signs are in the correct location and can be read. Illustrations of safety sign locations are located at the rear of this section.

Replace any safety signs that can not be read or are missing. Clean the machine surface thoroughly with a cleaning solution before replacing signs. Replacement safety signs are available from your dealer.

A WORD TO THE OPERATOR

FIG. 17: It is YOUR responsibility to read and understand the safety section in this manual and the manual for all attachments before operating this machine. Remember YOU are the key to safety. Good safety practices not only protect you, but also the people around you.

Study the features in this manual and make them a working part of your safety program. Keep in mind that this safety section is written only for this type of machine. Practice all other usual and customary safe working precautions, and above all **REMEMBER - SAFETY IS YOUR RESPONSIBILITY. YOU CAN PREVENT SERIOUS INJURY OR DEATH.**

This safety section is intended to point out some of the basic safety situations that may be encountered during the normal operation and maintenance of your machine. This section also suggests possible ways of dealing with these situations. This section is NOT a replacement for other safety practices featured in other sections of this manual.

Personal injury or death may result if these precautions are not followed.

Learn how to operate the machine and how to use the controls properly.

Do not let anyone operate the machine without instruction and training.

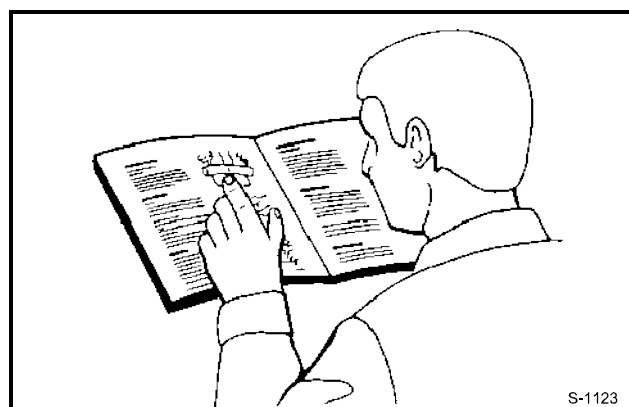

FIG. 17

General Information

For your personal safety and the personal safety of others, follow all safety precautions and instructions found in the manuals and on safety signs affixed to the machine and all attachments. Use only approved attachments and equipment.

Make sure your machine has the correct equipment needed by the local regulations.



WARNING: An operator should not use alcohol or drugs which can affect their alertness or coordination. An operator on prescription or 'over the counter' drugs needs medical advice on whether or not they can properly operate machines.



CAUTION: If any attachments used on this equipment have a separate Operator Manual, see that manual for other important safety information.

OPERATOR MANUAL

This manual covers general safety practices for this machine. The Operator Manual must always be kept with the machine.

Right-hand and left-hand, as used in this manual, are determined by facing the direction the machine will travel when in use.

The photos, illustrations, and data used in this manual were current at the time of printing, but due to possible in-line production changes, your machine can vary slightly in detail. The manufacturer reserves the right to redesign and change the machine as necessary without notification.



WARNING: In some of the illustrations and photos used in this manual, shields or guards may have been removed for clarity. Never operate the machine with any shields or guards removed. If the removal of shields or guards is necessary to make a repair, they **MUST** be replaced before operation.

PREPARE FOR OPERATION

Read and understand all operating instructions and precautions in this manual before operating or servicing the machine.

Make sure you know and understand the positions and operations of all controls. Make certain all controls are in neutral and the parking brake is applied before starting the machine.

Make certain all people are well away from your area of work before starting and operating the machine. Check and learn all controls in an area clear of people and obstacles before starting your work. Be aware of the machine size and have enough space available to allow for operation. Never operate the machine at high speeds in crowded places.

Emphasize the importance of using correct procedures when working around and operating the machine. Do not let children or unqualified persons operate the machine. Keep others, especially children, away from your area of work. Do not permit others to ride on the machine.

Make sure the machine is in the proper operating condition as stated in the Operator Manual. Make sure the machine has the correct equipment required by local regulations.

All equipment has a limit. Make sure you understand the speed, brakes, steering, stability, and load characteristics of this machine and the tractor before you start.



Suggest:

For more complete manuals. Please go to the home page.

<https://www.ebooklibonline.com>

If the above button click is invalid. Please download this document first, and then click the above link to download the complete manual.

Thank you so much for reading

General Information

OPERATION

General Information

FIG. 18: When parking, park the machine and the tractor on a solid level surface. Put all controls in neutral, put the tractor transmission in PARK, and apply the tractor parking brake. Stop the tractor engine and take the key with you.

Make sure the tractor and implement are in the proper operating condition according to the operators manuals. Make sure the tractor brakes and the machine brakes, if equipped, are adjusted correctly.

The tractor must have enough weight and braking capacity, especially when operating on roads and terrain that is not even. Use a tractor of recommended size and weight to tow the machine. See Specifications for the minimum tractor size and weight.

Tractor must be equipped with rollover protective structure (ROPS), and a seat belt. Use seat belt during operation.

Do not dismount from moving machinery.

Always operate the machine with the control console turned on.

Never start the tractor with PTO engaged or control console turned on.

Where possible avoid operating the baler near ditches, embankments and holes. Reduce speed when turning, crossing slopes, and on rough, slippery, or muddy surfaces.

Stay off slopes too steep for operation.

Be aware of the size of the equipment and have enough space available to allow for operation.

Always slide the hitch pin lock plate over the hitch pin and install the Klik pin when connecting the baler to the tractor.

To achieve proper braking capacity, the weight of the baler with a bale must not exceed 1.5 times the weight of the tractor.

Do not stand between the tractor and the implement to install the hitch pin when the tractor engine is running.

FIG. 19: Avoid contact with electrical power lines. Contact with electrical power lines can cause electrical shock, resulting in very serious injury or death.

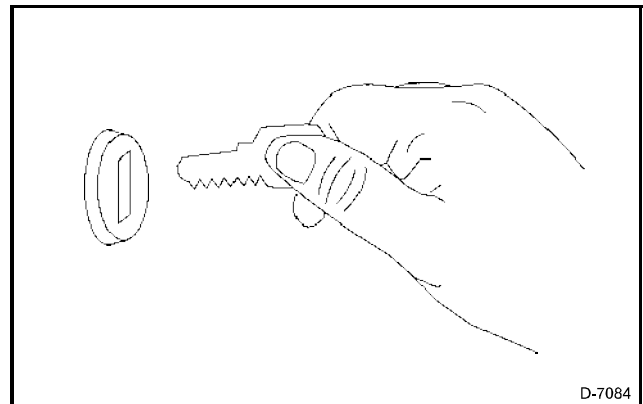

FIG. 18

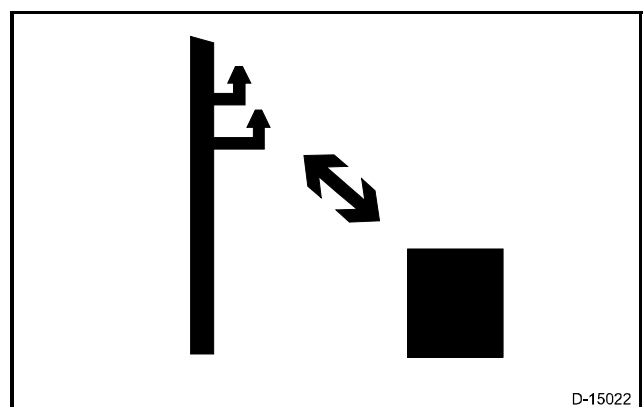

FIG. 19

FIG. 20: Stay at least 3.7 m (12 ft) away from the tailgate and kicker at all times. The tailgate and kicker operate faster than you can move away.

Always make sure the area around the tailgate and the kicker is clear for at least 3.7 m (12 ft) before opening the tailgate and unloading the bale. Keep bystanders away from the baler and the tailgate when unloading a bale.

Before raising the tailgate, make sure the baler is securely fastened to the tractor drawbar. The baler tongue may lift up when the tailgate is raised. This can cause the baler to tip to the rear, causing personal injury or damage to the machine.

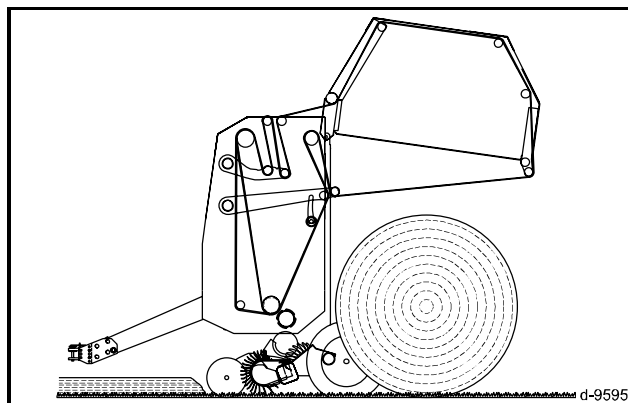

FIG. 20

FIG. 21: When moving bales, never use a tractor front end loader that is not equipped with a grapple or the proper bale handling equipment. Use the grapple to prevent the bale from rolling down the loader frame onto the operator. Always keep the load close to the ground to keep from off-balancing the tractor.

Never unload or store bales on a slope where bales can roll.

Always disengage the tractor PTO, put the tractor transmission in PARK and apply the parking brake before getting off of the tractor. Stop the tractor engine and remove the key before servicing or doing any maintenance on the machine.

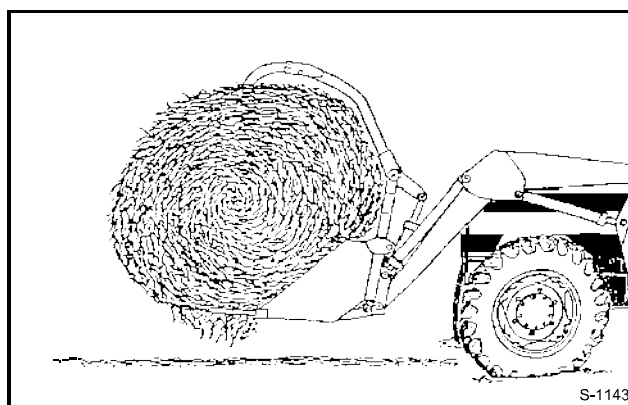

FIG. 21

PPE (Personal Protection Equipment)

FIG. 22: Wear all personal protective equipment (PPE) and protective clothing issued to you or called for by job conditions and country/local regulations. PPE includes, but is not limited to, equipment to protect eyes, lungs, ears, head, hands and feet when operating, servicing or repairing equipment.

Always keep hands, feet, hair, and clothing away from moving parts. Do not wear loose clothing, jewelry, watches, or other items that could entangle in moving parts. Tie up long hair that can also entangle in moving parts.

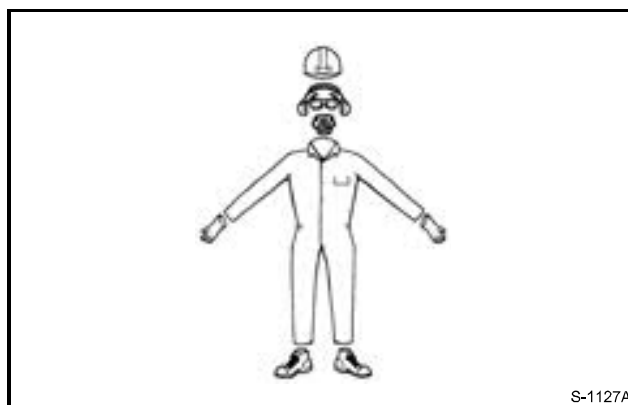

FIG. 22

<https://www.ebooklibonline.com>

Hello dear friend!

Thank you very much for reading.

Enter the link into your browser.

The full manual is available for immediate download.

<https://www.ebooklibonline.com>