

AGCO SISU POWER

Workshop Manual

4th Generation Engines

8370 79492

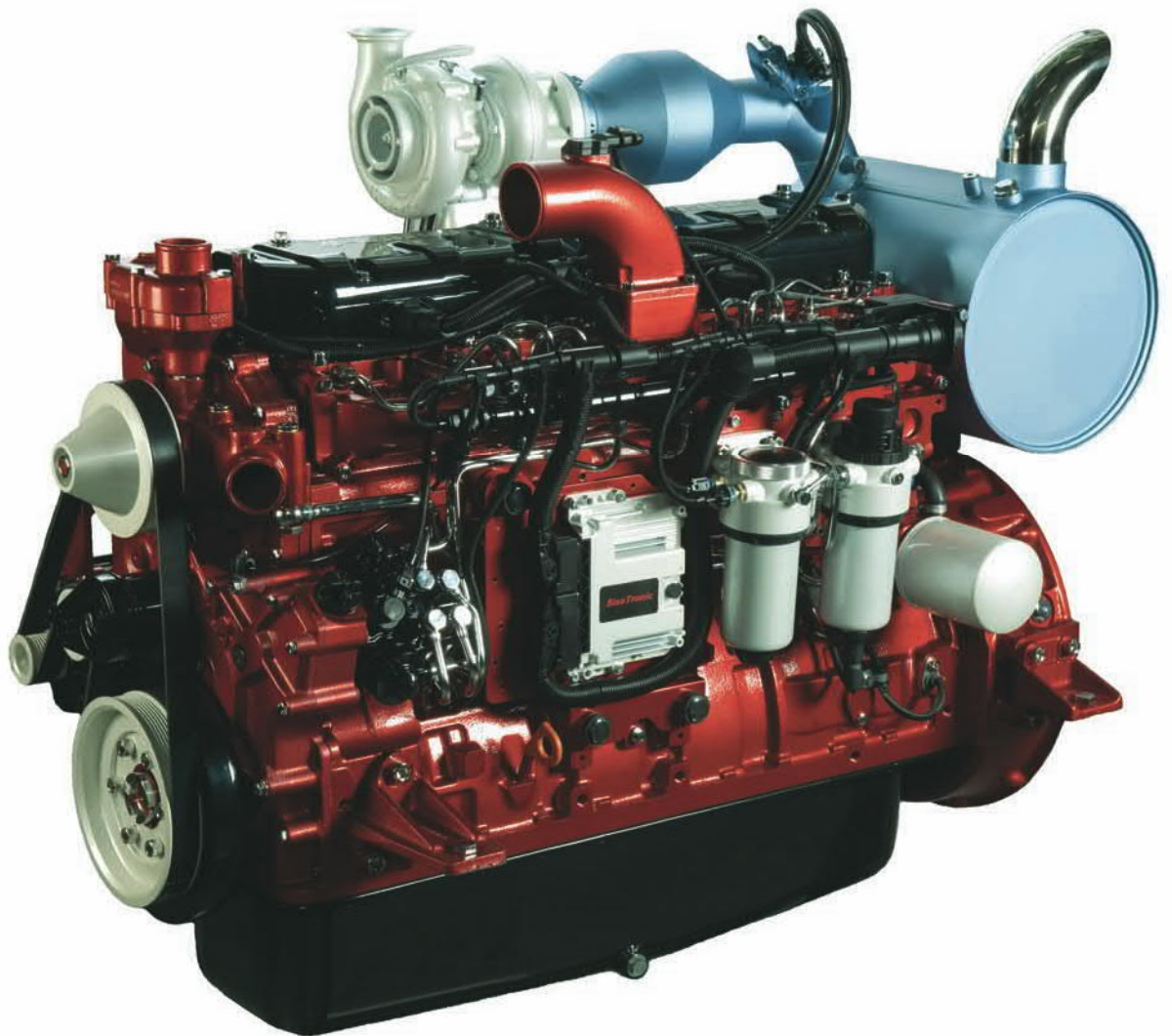

CONTENT

GENERAL

TO THE USER	1
SAFETY INSTRUCTIONS	2
ENGINE TYPE DESIGNATIONS	4
LOCATION OF THE ENGINE SERIAL NO.	4
MARKING OF THE EEM 4 CONTROL UNIT	5
LIFTING THE ENGINE	5

CONSTRUCTION

Technical Data	6
General	7
Cylinder Block	7
Flywheel Housing	7
Valve Mechanism	7
Cylinder Head	8
Crank Mechanism	8
Timing Gears	9
Lubricating System	10
Cooling System	11
Inlet and Exhaust System	12

TECHNICAL DATA

Cylinder Block	13
Cylinder Liners	13
Cylinder Head	14
Valves and Rockers	14
Tappets and Push Rods	15
Camshaft	15
Crankshaft	15
Flywheel	17
Balancing Unit	18
Timing Gears	18
Connecting Rod	18
Piston, Rings and Pin	19
Lubricating System	20
Oil Pump	20
Coolant Pump	21
Thermostat	22
Turbocharger	22

TIGHTENING TORQUES	23
--------------------------	----

SPECIAL TOOLS

Cylinder Block	24
Timing Gear and Flywheel Housing	25
Cylinder Head and Valve Mechanism	26
Crank Mechanism	27
Coolant Pump	28
Fuel System	29

WORK INSTRUCTIONS

1. CYLINDER BLOCK	
1.1. Measuring cylinder liner wear	.31
1.2. Removing cylinder liner	.31
1.3. Checking cylinder block	.31
1.4. Changing camshaft bushing	.32
1.5. Fitting plug at camshaft rear end	.33
1.6. Oversize bushings for camshaft	.33
1.7. Fitting plug at camshaft rear end (oversize bushings)	.34
1.8. Fitting cylinder liner	.34
2. FLYWHEEL HOUSING	
2.1. Fitting flywheel housing	.37
2.2. Changing crankshaft rear oil seal	.37
3. CYLINDER HEAD	
3.1. Removing cylinder head	.39
3.2. Removing valves	.39
3.3. Checking cylinder head	.40
3.4. Changing valve guides	.40
3.5. Machining valve seat	.41
3.6. Changing valve seat rings	.41
3.7. Grinding valves	.42
3.8. Fitting valves	.42
3.9. Fitting cylinder head	.42
4. VALVE MECHANISM	
4.1. Reconditioning valve mechanism	.45
4.2. Changing camshaft / camshaft gear	.46
4.3. Adjusting valves	.47
5. CRANKSHAFT	
5.1. Removing crankshaft	.49
5.2. Checking crankshaft	.49
5.3. Changing crankshaft gears	.50
5.4. Fitting crankshaft	.50
5.5. Crankshaft hub piece	.51
5.6. Checking element of the rubber damper	.52
5.7. Viscose type Vibration Damper	.52
6. CONNECTING RODS AND PISTONS	
6.1. Removing Pistons Together with Connecting Rods	.53
6.2. Changing Connecting Rod Bearings	.53
6.3. Checking Connecting Rod	.54
6.4. Changing Piston Rings	.55
6.5. Checking Pistons	.55
6.6. Fitting Piston Pin	.56
6.7. Fitting Piston Together with Connecting Rod	.56
7. COUNTERBALANCE (44- and 49-Engines)	
7.1. Removing and Disassembling Counterbalance Unit	.57
7.2. Reconditioning Counterbalance Unit	.57
7.3. Fitting Counterbalance Unit	.58
7.4. Changing Crankshaft Gear Rim	.58

<https://www.ebooklibonline.com>

Hello dear friend!

Thank you very much for reading.

Enter the link into your browser.

The full manual is available for immediate download.

<https://www.ebooklibonline.com>

8. FLYWHEEL	
8.1. Changing Starter Ring Gear on Flywheel	.59
8.2. Fitting Flywheel	.59
9. TIMING GEAR ASSEMBLY	
9.1. Removing Timing Gear Casing	.61
9.2. Fitting Timing Gear Casing	.62
9.3. Fitting the Crankshaft Hub, 98	.63
9.4. Power Take-off	.64
9.5. Fan Drive Device	.64
10. LUBRICATION SYSTEM	
10.1. Oil Pressure Regulating Valve	.65
10.2. Removing and Dismantling Lubricating Oil Pump	.65
10.3. Assembling and Fitting Lubricating Oil Pump	.66
10.4. Piston Cooling Nozzles	.66
10.5. Fitting Oil Sump Gasket	.67
10.6. Lubricating Oil Cooler	.67
10.7. Lubricating Oil Quality Requirements	.68
10.8. Oil Capacities	.69
10.8. Closed Crankcase Ventilation (CCV)	.69
11. COOLING SYSTEM	
11.1. Quality Requirements of Coolant	.71
11.2. Thermostat	.71
11.3. Reconditioning Coolant Pump	.72
11.4. Coolant Pumps with Heavy Duty Bearings	.74
11.5. Installing the Cylinder Head Connection Part	.76
12. INLET AND EXHAUST SYSTEM	
12.1. Checking the Air Cleaner	.77
12.2. Checking the Inlet and Exhaust Pipes	.77
12.3. Checking the Turbocharger.	.78
12.4. Fitting the Turbocharger	.79
12.5. EGR System	.80
13. FUEL SYSTEM	
13.1. Technical Data	.84
13.2. Bleeding Fuel System	.85
13.3. Measuring Fuel Feed Pressure	.85
13.4. Inspecting Injectors	.86
13.5. High-Pressure Pump	.88
13.6. Rail	.89
13.7. Fuel Quality Requirements	.90
13.8. SCR System	.91
14. EEM4 ENGINE CONTROL SYSTEM	
14.1. Construction of the EEM4	.95
14.2. EEM4 Engine Control System, Description	.96
14.3. Service Tool of the EEM4 System	.96
14.4. Changing the Control Unit (ECU)	.97
14.5. Wiring Sets	.98
14.6. Sensors of the Engine Control System	.100

15. ELECTRICAL SYSTEM

15.1. Alternators	103
15.2. Starters	106

GENERAL

TO THE USER

This Workshop Manual is intended to assist with workshop operations and repair work.

4th Generation engines (types 33, 44, 49, 66, 74, 84 and 98) are generally of the same construction, so the same repair instructions will usually apply to various engine types. The differences between the various engine types, which affect repair work, are mentioned in the technical data and repair instructions. All measurements are in millimetres and valid when the temperature of the parts is +20°C, unless otherwise stated.

Before starting any repair work, please read the safety instructions at the beginning of this book. Make sure that you have all the necessary tools, parts and accessories to hand. The special tools mentioned in the work instructions are not all essential, but they speed up and facilitate the work and contribute to successful execution of the work. An engine which has undergone repairs must be run in just like a new one.

Should the engine require work not described in this manual, please consult your local agent or the Service Department of AGCO SISU POWER Inc., Linnavuori, Finland. To facilitate consulting, find out the following facts about the engine before contacting us:

- engine type
- engine number
- model or equipment
- hours operated or kilometres driven.





This Workshop Manual does not cover the regular service procedure as this is explained in the 4th Generation series Instruction Manual.

As AGCO SISU POWER Inc. is continuously developing its products, all rights are reserved to alter the specifications, accessories and the service and repair procedure without separate notice.

SAFETY INSTRUCTIONS

There is always the risk of injury when using or servicing the engine. Before starting the service, please ensure you have read and understood the following safety instructions and remarks!

- ⚠ Do not start any repair work that you do not fully understand.
- ⚠ Make sure that the location and surroundings in which you are carrying out the repair provide a safe environment in which to work.
- ⚠ Always ensure the location is clean and free of clutter.
- ⚠ Do not use faulty or otherwise unsuitable tools.
- ⚠ Remove all rings, chains and watches before starting work.
- ⚠ Use up-to-date protection equipment while you work. For example, eye protection, as you will be working with compressed air for cleaning, grinding, hammering or similar.
- ⚠ Use a lifting device for lifting and transporting heavy (over 20 kg) pieces. Ensure all lifting hooks and chains are in good condition. The lifting eyes on the engine must not be subjected to side forces during lifting.
- ⚠ Never work under an engine that is hanging from a lifting device or raised up on a jack. Always use strong supports before starting the work.
- ⚠ Use only genuine **AGCO Sisu Power** spare parts.
- ⚠ Start the engine only by using the starting switch in the cabin.
- ⚠ Do not start an engine if the protection covers are removed. **Note!** The fan is difficult to see when the engine is running! Ensure that loose clothing or long hair does not get caught in the rotating parts of the engine.
- ⚠ If you start the engine indoors, ensure that there is proper ventilation.
- ⚠ Never use an aerosol starting aid! (Risk of explosion, personal injuries and engine damage.)
- ⚠ When you are operating the engine or working near it, use ear protection to avoid noise injuries.
- ⚠ Always stop the engine before starting any servicing or repair work.
- ⚠ Avoid touching the exhaust manifold, turbocharger and any other hot parts of the engine.
- ⚠ Open the radiator cap with care when the engine is hot, as the cooling system is pressurised. The cooling liquid and lubrication oil of a hot engine will cause injury if they come into contact with skin.
- ⚠ Do not open high pressure pipe connectors of the fuel system when the engine is running. Wait at least 30 sec. after the stopping of the engine. If the jet of high pressure fuel contacts your skin, fuel penetrates the skin causing severe injuries. Get medical help immediately!
- ⚠ Never allow a naked flame, smoking or sparks near the fuel system or batteries, especially when loading batteries, as these are explosive.
- ⚠ Always disconnect the negative (-) battery cable when servicing or repairing the electric system.

-  At temperatures in excess of 300°C, e.g. if the engine is burnt by a fire, the viton seals of the engine (i.e. the undermost cylinder liner O-ring) produce very highly corrosive hydrofluoric acid. Do not touch with bare hands when viton seals are subjected to abnormally high temperatures. Always use neoprene rubber or heavy-duty gloves and safety glasses when decontaminating. Wash the seals and the contaminated area with a 10% calcium hydroxide or other alkali solution. Put all removed material in sealed plastic bags and deliver them to the relevant disposal point provided by the authorities concerned. **Note!** Never destroy viton seals by burning!
-  When checking fuel injectors do not allow the jet of high-pressure fuel to come into contact with your skin. The fuel penetrates the skin causing severe injuries. Get medical help immediately!
-  The fuel, lubricating oil and coolant cause long-lasting irritation on contact with skin.
-  If you are carrying out welding or similar high current operations for the appliance, we recommend that you disconnect the EEM4 control unit main connector before starting work.

Avoid unnecessary idling of the engine.

Do not let oil and other liquids to the environment when servicing the engine. Take them to a proper disposal point.

All the engine gaskets are made of non-asbestos material.

Be careful when washing the engine with high-pressure washing machine equipment. Do not use high pressure to wash e.g. the electric and fuel equipment or the radiator because they can easily be damaged.



Suggest:

For more complete manuals. Please go to the home page.

<https://www.ebooklibonline.com>

If the above button click is invalid. Please download this document first, and then click the above link to download the complete manual.

Thank you so much for reading

ENGINE TYPE DESIGNATIONS

74 A W I G

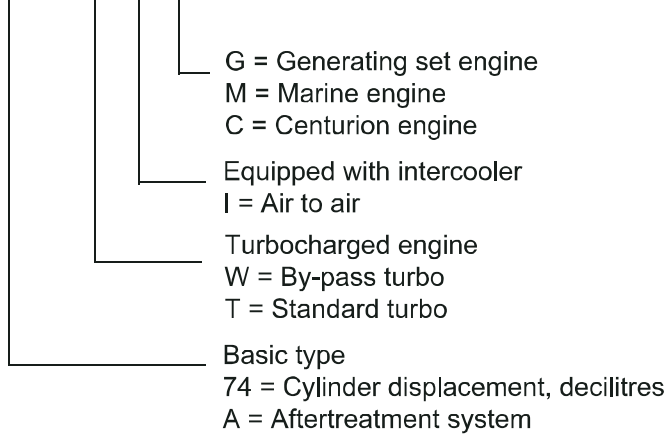

LOCATION OF THE ENGINE SERIAL NO.

The engine serial number is always stamped on the cylinder block as shown in the picture.

The serial number is also marked on the type plate.

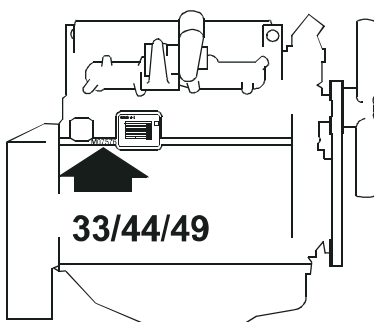
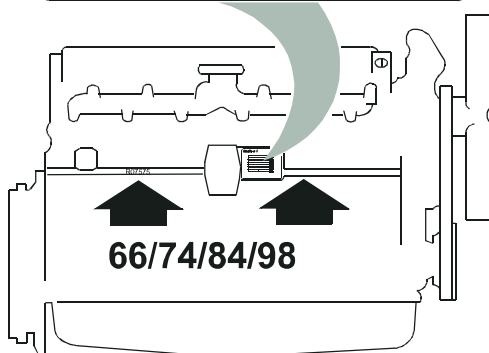
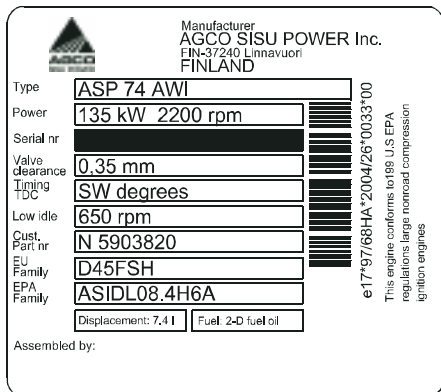

AGCO SISU POWER

MARKING OF THE EEM 4 CONTROL UNIT

The model specification is indicated on the type plate of the EEM 4 control unit. This specification must always be stated when ordering a control unit or requesting adjusted settings.

Note! The engine meets EU97/68/EC Stage IIIB and EPA 40 CFR 89 Tier 4i emission requirements.

Do not fit any components on the engine other than those originally intended for it. The use of parts other than original Sisu Power spare parts will invalidate the responsibility of AGCO SISU POWER Inc. with respect to the fulfilment of the emission requirements.

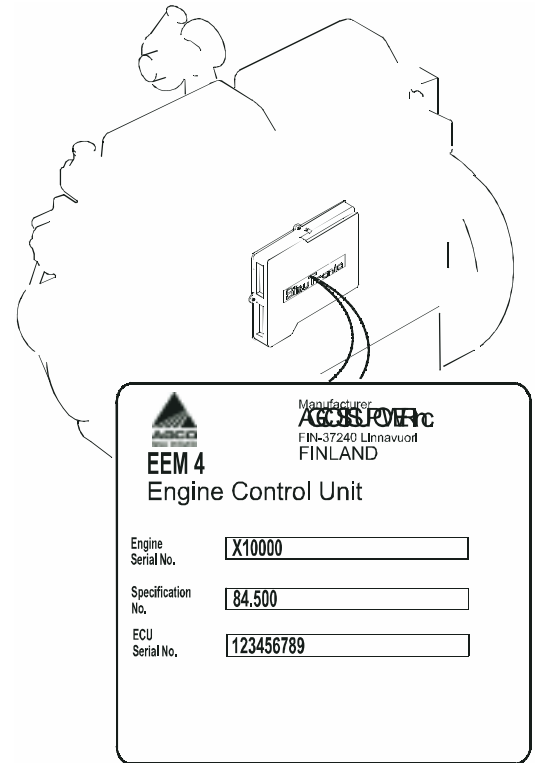

LIFTING THE ENGINE

Safe lifting of the engine is done with a lifting device where the lifting force affects the lifting eyes vertically.

Weight of engine

Engine type	Weight kg *)
33	330
44	345
49	345
66	515
74	525
84	650
98	790

*) Dry weight without flywheel, electrics, SCR and CCV components

A = Engine lifting eyes

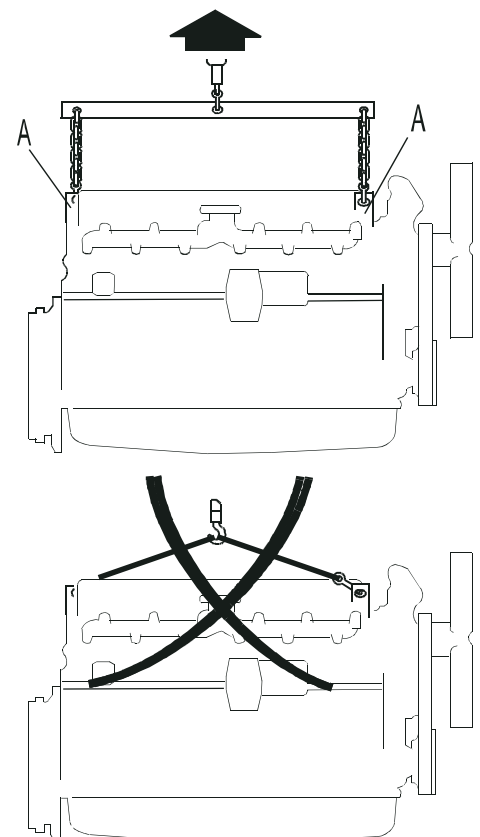

<https://www.ebooklibonline.com>

Hello dear friend!

Thank you very much for reading.

Enter the link into your browser.

The full manual is available for immediate download.

<https://www.ebooklibonline.com>