

9125 / 9145
Auger Header
Workshop Service Manual

MASSEY FERGUSON®

9125 / 9145

Auger Header

4283389M1

CONTENTS

SAFETY	01
GENERAL INFORMATION	02
ELECTRICAL	03
HYDRAULICS	04
GEARBOXES	05
REEL	06
SICKLE	07
AUGER	08
HAY CONDITIONER.....	09
TROUBLESHOOTING	10
SPECIFICATIONS	11
INDEX	12

NOTES

<https://www.ebooklibonline.com>

Hello dear friend!

Thank you very much for reading.

Enter the link into your browser.

The full manual is available for immediate download.

<https://www.ebooklibonline.com>

Massey Ferguson®

9125 / 9145
Auger Header

WORKSHOP SERVICE MANUAL
4283389M1

01 - Safety

Contents

Safety Alert Symbol	01-3
Safety Messages	01-3
Informational Messages	01-4
Safety Signs	01-4
Operator Manual	01-5
A Word to the Operator	01-5
Prepare for Operation	01-6
Operation	01-7
Travel on Public Roads	01-9
Fire Prevention	01-10
Maintenance	01-11
Accumulators	01-13
Cylinder Stops	01-13

NOTES

SAFETY

SAFETY ALERT SYMBOL

FIG. 1: The safety alert symbol means ATTENTION! BECOME ALERT! YOUR SAFETY IS INVOLVED!

Look for the safety alert symbol both in this manual and on safety signs on this machine. The safety alert symbol will direct your attention to information that involves your safety and the safety of others.



FIG. 1

SAFETY MESSAGES

FIG. 2: The words DANGER, WARNING or CAUTION are used with the safety alert symbol. Learn to recognize these safety alerts and follow the recommended precautions and safety practices.

 **DANGER:** Indicates an imminently hazardous situation that, if not avoided, will result in DEATH OR VERY SERIOUS INJURY.

 **WARNING:** Indicates a potentially hazardous situation that, if not avoided, could result in DEATH OR SERIOUS INJURY.

 **CAUTION:** Indicates a potentially hazardous situation that, if not avoided, may result in MINOR INJURY.



FIG. 2

Safety

INFORMATIONAL MESSAGES

The words IMPORTANT and NOTE are not related to personal safety, but are used to give additional information and tips for operating or servicing this equipment.

IMPORTANT: Identifies special instructions or procedures which, if not strictly observed, could result in damage to or destruction of the machine, process, or its surroundings.

NOTE: Identifies points of particular interest for more efficient and convenient repair or operation.

SAFETY SIGNS



WARNING: DO NOT remove or obscure Danger, Warning or Caution signs. Replace any Danger, Warning or Caution signs that are not readable or are missing. Replacement signs are available from your dealer in the event of loss or damage.

If a used machine has been purchased, make sure all safety signs are in the correct location and can be read.

Replace any safety signs that can not be read or are missing. Replacement safety signs are available from your dealer.

OPERATOR MANUAL

FIG. 3: The Operator Manual is stored in the holder (1) located on the windrower tractor. After using the Operator Manual, return the manual to the storage location.

Right-hand and left-hand, as used in this manual, is determined by facing the direction the machine will travel when in use.

The photos, illustrations, and data used in this manual were current at the time of printing, but due to possible in-line production changes your machine can vary slightly in detail. The manufacturer reserves the right to redesign and change the machine as necessary without notification.



WARNING: In some of the illustrations or photos used in this manual, panels or guards may have been removed for clarity. Never operate the machine with any panels or guards removed. If the removal of panels or guards is necessary to make a repair, they **MUST** be replaced before operation.



FIG. 3

A WORD TO THE OPERATOR

FIG. 4: It is **YOUR** responsibility to read and understand the safety division in this manual before operating this machine. Remember **YOU** are the key to safety. Good safety procedures not only protect you, but also the people around you.

Study the features in this manual and make them a working part of your safety program. Keep in mind this safety division is written only for this type of machine. Practice all other normal and customary safe working precautions, and above all **REMEMBER - SAFETY IS YOUR RESPONSIBILITY. YOU CAN PREVENT SERIOUS INJURY OR DEATH.**

This safety division is intended to point out some of the basic safety situations may be found during the normal operation and maintenance of this machine, and to suggest possible ways of dealing with these situations. This division is **NOT** a replacement for safety procedures featured in other divisions of this manual.

NOTE: *This manual covers general safety procedures for this machine. This manual must always be kept with the machine. Return the manual to the storage location after use.*



CAUTION: Refer to the tractor Operator Manual for other important safety information.

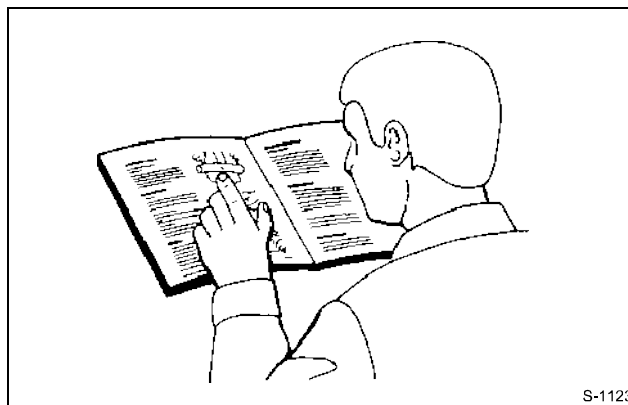

FIG. 4

Safety

PREPARE FOR OPERATION

Emphasize the importance of using correct procedures when working around and operating the machine. **DO NOT** let unqualified persons to operate your machine. Keep others, especially children, away from your area of work. **DO NOT** permit others to ride on the machine.

Read and understand all operating instructions and precautions in this manual before operating or servicing the machine. Make sure you know and understand the positions and operations of all controls.

Make sure the machine is in the proper operating condition as stated in this Manual. Make sure the machine has the correct equipment needed by local regulations.

Make certain all controls are in neutral and the parking brake is engaged before starting the machine. Make certain all people are well away from your area of work before starting and operating the machine.



WARNING: Any time the engine is running and the parking brake is disengaged, the machine will turn if the steering wheel is moved even though the travel control lever is in neutral.

All equipment has a limit. Make sure you understand the speed, brakes, steering, stability, and load characteristics of the machine before you start. Check all controls in an area clear of people and obstacles before starting your work.

Be aware of the machine size and have enough space available to allow for operation. Never operate the machine at high speeds in crowded places.



WARNING: An operator should not use alcohol or drugs which can affect their alertness or coordination. An operator taking prescription or 'over the counter' drugs needs medical advice on whether or not they can properly operate machines.

OPERATION

FIG. 5: All shields and guards must be in the correct operating position and in good condition.

DO NOT use attachments unless the attachments are approved optional equipment.

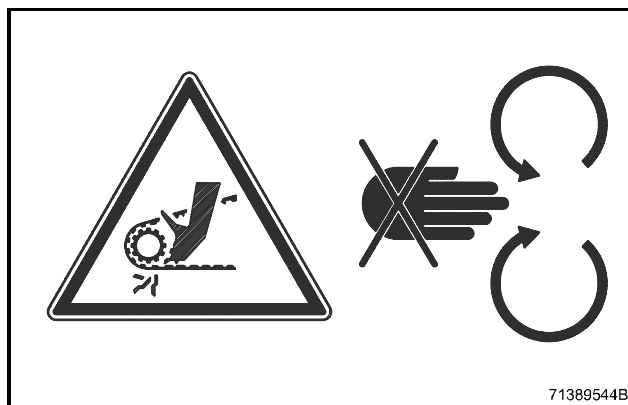

FIG. 5

FIG. 6: Do not operate the machine with drive shaft shields open or removed. Entanglement in rotating drive shafts can cause serious injury or death. Stay clear of rotating components.

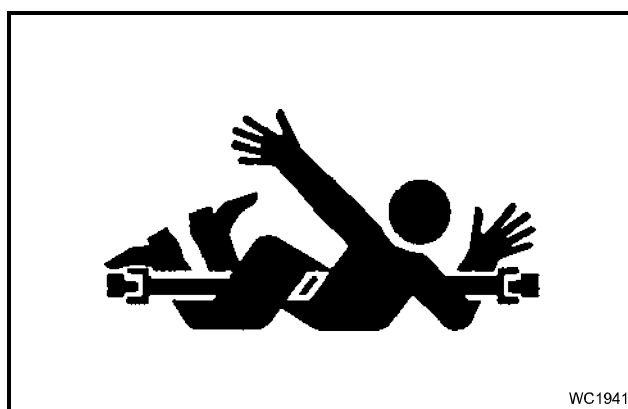

FIG. 6

FIG. 7: Never stand near the machine during operation. Debris can be thrown from the machine during operation possibly resulting in injury.

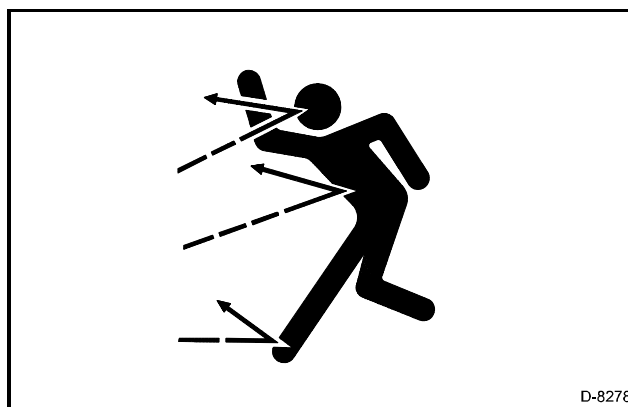

FIG. 7

Safety

FIG. 8: Wear all protective clothing and personal protective equipment issued to you or called for by job conditions.

Wear approved hearing protection whenever operating the machine as required by country/local regulations.

DO NOT wear loose clothing, jewelry, watches, or other items which could entangle in moving parts. Tie up long hair which can also entangle in moving parts.

Always keep hands, feet, hair, and clothing away from moving parts.

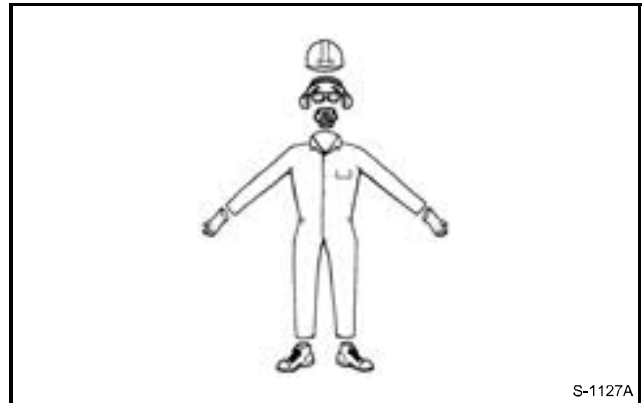

FIG. 8

FIG. 9: Securely fasten the seat belt before operating the machine. Always remain seated and have the seat belt fastened while operating the machine. Replace the seat belts when they become worn or broken.

Never wear a seat belt loosely or with slack in the belt system. Never wear the seat belt in a twisted condition or pinched between the seat structural members.

Securely fasten the seat belt when using the instructional seat, if equipped. The instructional seat is to be used only to train new operators or diagnose a problem. The instructional seat is only intended for short periods of use. Extra riders, especially children, are not permitted on the machine.

When the instructional seat is used the machine must be driven at a slower speed and on level ground. Avoid quick starts, stops, and sharp turns. Avoid driving on highways or public roads.

FIG. 10: Stay off slopes too steep for operation. Keep the header as low as possible while going down hills. Never suddenly reverse the wheels to stop or back up.

Where possible avoid operating the machine near ditches, embankments, and holes. Reduce ground speed when operating on rough, slippery, or muddy surfaces and when turning or crossing slopes.

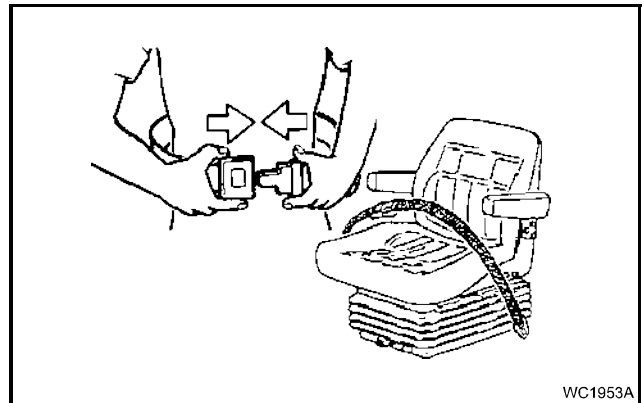

FIG. 9

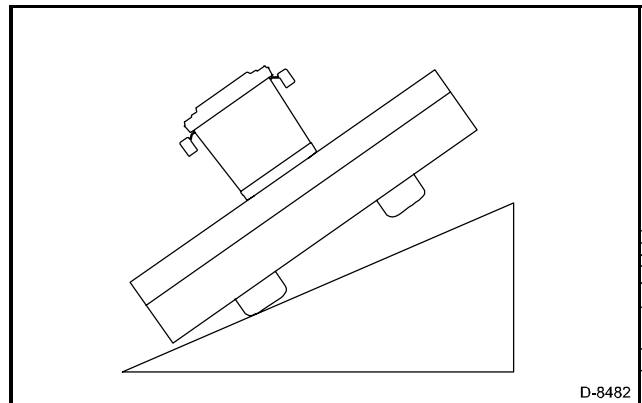

FIG. 10

FIG. 11: When parking, put the machine on a solid level surface and lower the header to the ground. Put all controls in neutral, center and lock the steering wheel, and engage the parking lock control lever. Stop the tractor engine and take the key with you when parking the machine.



WARNING: Do not leave the machine unattended with the header raised. Lower the header fully before leaving the machine. A sudden loss of hydraulic pressure can cause the header to drop without warning.

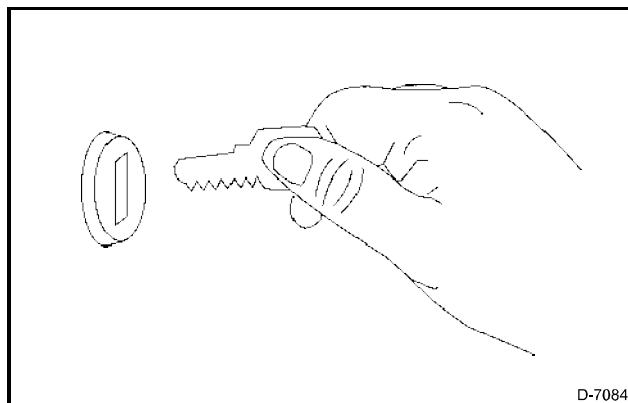

FIG. 11

D-7084

TRAVEL ON PUBLIC ROADS

FIG. 12: Use the lighting and marking system supplied with the machine when roading. Make sure all the flashers are operating prior to driving on the road. Make sure the reflectors are installed, in good condition, and wiped clean. Be sure the SMV emblem is clean, visible, and correctly mounted on the rear of the machine.

Familiarize yourself with and obey all road regulations which apply to your machine. Consult your local law enforcement agency for local regulations regarding movement of farm equipment on public roads.

Adjust travel speed to maintain control at all times. Limit speeds to 24 km/h (15 mph). Be aware of other traffic on the road. Keep well over to your own side of the road and pull over, when possible, to let faster traffic pass.

Be aware of the overall width and length of the machine. Be careful when transporting the machine on narrow roads and across narrow bridges.

Always travel with the header as low as possible. **DO NOT** drive with header up and the lift cylinder stops in the locked position. See Cylinder Stops in this division for more information.

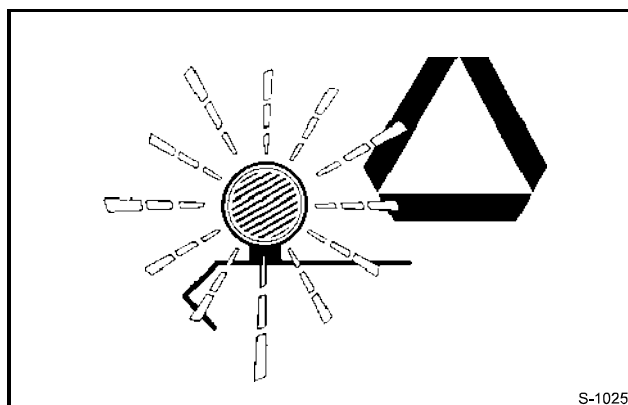

FIG. 12

S-1025

Safety

FIRE PREVENTION

FIG. 13: Because of the nature of the crops this machine will operate in, the risk of fire is present. Regular inspection of the machine can reduce the risk of fire.

Keep the machine free of crop debris to help prevent fires.

Check the machine daily for any noises which are not normal. Such noises could indicate a failed bearing and can cause heat build up.

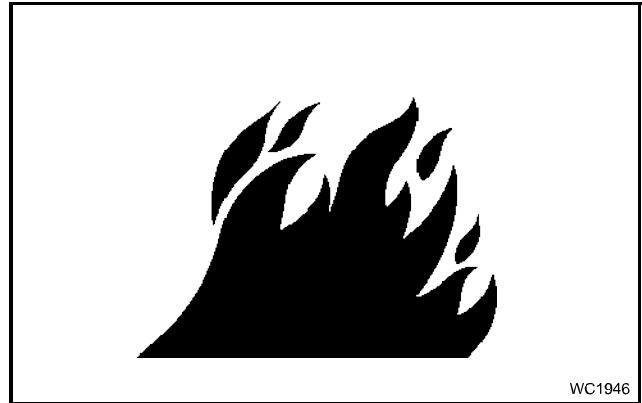

FIG. 13

FIG. 14: Because of the flammable nature of many crops, a fire extinguisher must be located within easy reach of the operator. Check the fire extinguisher regularly as instructed by the manufacturer.

Keep an emergency first aid kit handy for treatment of minor burns, cuts, or scratches.

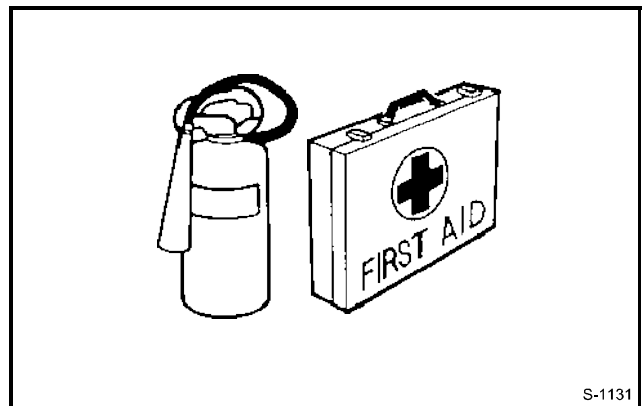

FIG. 14

MAINTENANCE

FIG. 15: Before doing any unplugging, lubricating, servicing, cleaning, or adjusting park the tractor on a solid level surface. Put all controls in neutral, center and lock the steering wheel, and engage the parking lock control lever. Stop the tractor engine and take the key with you.

LOOK AND LISTEN! Make sure all moving parts have stopped.

Always chock the wheels before working on or under the machine.

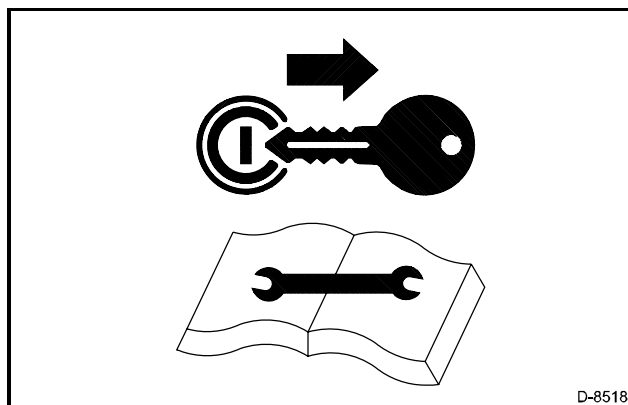

FIG. 15

FIG. 16: When working on the machine make sure the header is lowered to the ground.

When it is necessary for the header to be in the raised position, raise the header all the way and engage the header lift cylinder stops. See Cylinder Stops in this division for more information.



WARNING: Always install the header lift cylinder stops when working near the header. Do not rely on the hydraulic system to keep the header raised. A sudden loss of hydraulic pressure could cause the header to lower unexpectedly.

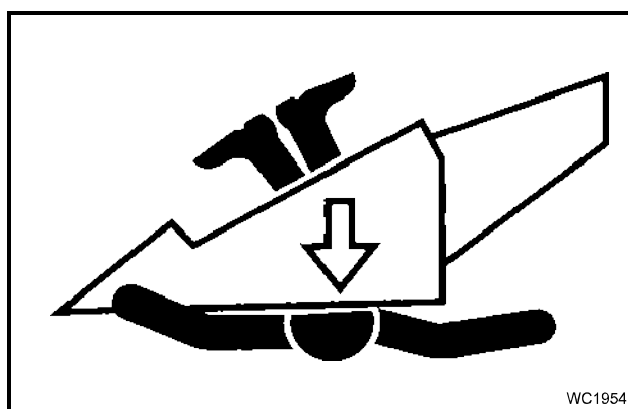

FIG. 16

FIG. 17: Never check, adjust, or lubricate chains or drive belts while the machine is running.

Never remove crop from the machine while the machine is running.

Moving parts can pull you in faster than you can move away!

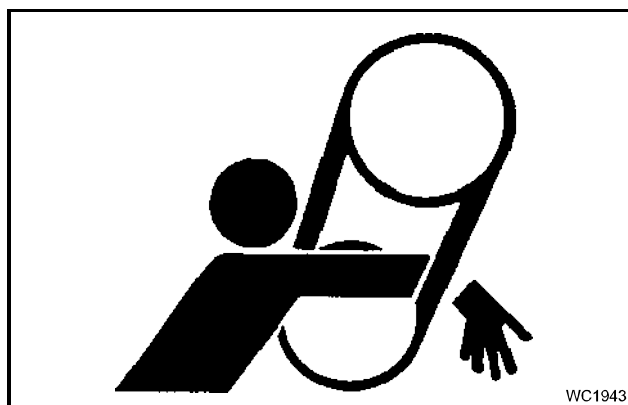

FIG. 17

Safety

FIG. 18: Hydraulic fluid escaping under pressure can have sufficient force to penetrate the skin, causing serious injury.

Fluid injected into the skin must be surgically removed within a few hours. If not treated immediately, a serious infection or toxic reaction can develop. See a doctor familiar with this type of injury immediately.

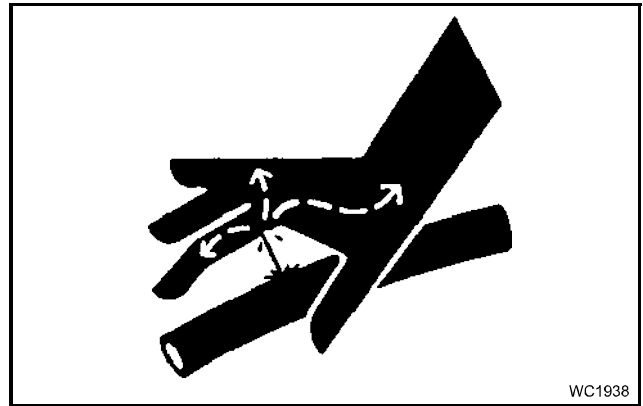

FIG. 18

FIG. 19: Hydraulic fluid escaping from a very small hole can be almost invisible. Use a piece of cardboard or wood to search for possible leaks, never use your hands. When checking for suspected leaks, wear leather gloves for hand protection and safety goggles for eye protection.

Be sure to relieve all pressure from hydraulic lines before disconnecting them. Before applying pressure to the system, make sure all hydraulic connections are tight and hydraulic lines have not been damaged.

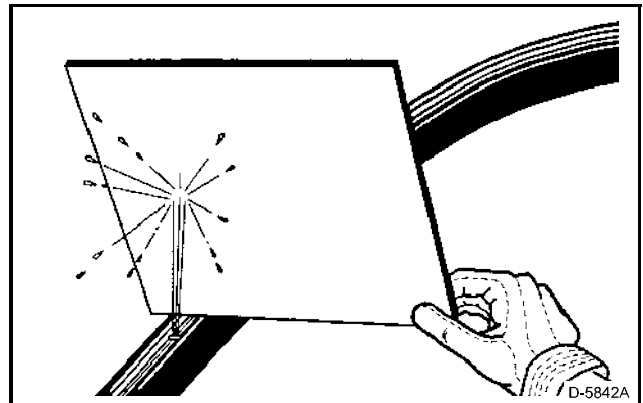

FIG. 19

Make sure electrical connectors are free of dirt and grease before connecting.

Check all nuts and bolts periodically for tightness. Check for loose, broken, missing, or damaged parts. Keep everything in good repair.

After unplugging, lubricating, servicing, cleaning, or adjusting the machine make sure all tools and equipment have been removed.

Make sure all shields and guards are in the correct position before operating the machine.

ACCUMULATORS

FIG. 20: The accumulators (1) are charged with dry nitrogen. Use only dry nitrogen when charging the accumulators. DO NOT use air or oxygen or an explosion will occur.

DO NOT drop the accumulators. Charged accumulators contains nitrogen under pressure. If the charging valves break away from the accumulators, the escaping nitrogen will propel the accumulators at a high rate of speed.



DANGER: Charging or replacing the accumulators must be performed by an authorized dealer only.

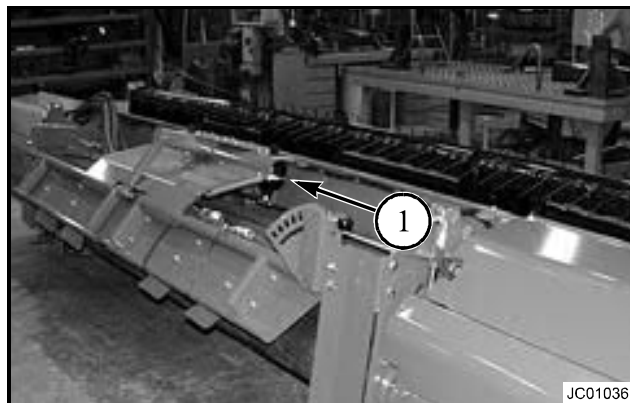

FIG. 20

CYLINDER STOPS

Both header lift cylinders have cylinder stops. The cylinder stops are activated by one lever outside the cab door.

FIG. 21: To engage the cylinder stops (1), raise the header completely. Move the lever (2) toward the cab and then pull back toward the rear of the machine to engage the cylinder stops. Make sure the cylinder stops are completely engaged in both header lift cylinders.

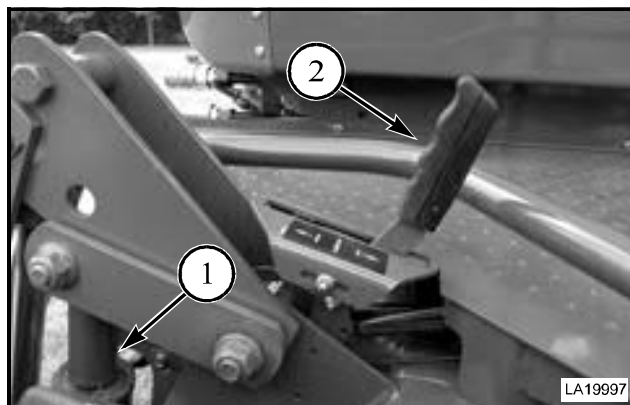

FIG. 21

FIG. 22: To disengage the cylinder stops, raise the header completely. Move the lever (1) toward the cab and then push forward toward the header to disengage the cylinder stops. Make sure the cylinder stops are completely disengaged from both header lift cylinders.

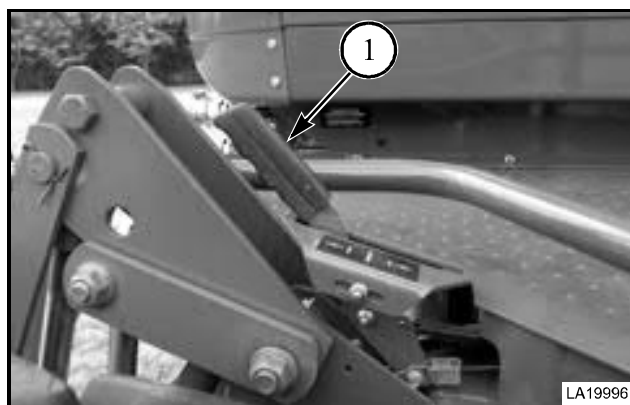

FIG. 22



Suggest:

For more complete manuals. Please go to the home page.

<https://www.ebooklibonline.com>

If the above button click is invalid. Please download this document first, and then click the above link to download the complete manual.

Thank you so much for reading

NOTES

Massey Ferguson®

9125 / 9145
Auger Header

WORKSHOP SERVICE MANUAL
4283389M1

02 - General Information

Contents

Introduction	02-3
Page Numbers	02-3
Units of Measurement	02-3
Replacement Parts	02-3
Machine Identification	02-3
Description - Single Conditioner	02-4
Crop Flow	02-4
Skid Shoes	02-5
Lean Bar	02-5
Reel	02-5
Cutterbar	02-5
Augers	02-5
Hay Conditioner	02-5
Swathboard	02-5
Forming Shields	02-5
Description - Double Conditioner	02-6
Crop Flow	02-6
Skid Shoes	02-7
Lean Bar	02-7
Reel	02-7
Cutterbar	02-7
Augers	02-7
Hay Conditioner	02-7
Swathboard	02-7
Forming Shields	02-7
Components Location	02-8
Components Access	02-9
End Shields	02-9
Drive Shields	02-10
Bolt Torque Values	02-11
Standard Bolt Torque Chart	02-11
Metric Bolt Torque Chart	02-11
Bearing Replacement	02-12
Gib Key Removal And Installation	02-13

<https://www.ebooklibonline.com>

Hello dear friend!

Thank you very much for reading.

Enter the link into your browser.

The full manual is available for immediate download.

<https://www.ebooklibonline.com>