

# Operator's Manual

HP | **MF400Xtra**  
110-130

Tractors

Models: MF 460, MF 470 and MF 480

6280531M1 - 02/10



INNOVATION - COMMITMENT - PROXIMITY - VISION - RELIABILITY - LEADERSHIP - SUPPORT - TECHNOLOGY



MASSEY FERGUSON

### Tractor models applied:

**MF 460, MF 470 and MF 480**

**Platform versions (Fig. 1) and with cab (Fig. 2)**

#### CONGRATULATION!

You have just acquired a modern, strong, reliable and unique tractor.

The 400Xtra Series tractors are the result of research, improvements and a large experience in industrial and agricultural equipment manufacturing. These tractors were designed to be operated in many different work conditions, showing an excellent performance, low fuel consumption and operational comfort.

Please carefully read this Manual before operating the tractor for the first time and also before performing any maintenance in the equipment. So you will be assuring the best performance and a long working life for your tractor.

At the Technical Delivery, please make sure the Dealer provides you all the necessary information. Besides the Genuine Replacement Parts, appropriate tools and factory trained personnel, only the Authorized Dealer can provide you reliable Technical Services.



Fig. 1



Fig. 2

Published by AGCO do Brasil,  
Canoas - Rio Grande do Sul - Brazil  
Publishing Code: **6280531M1**  
Edition: **02/10**  
AGCO do Brasil

This publication was prepared according to the international standard ISO3600 concerning information, content and layout of operator manuals supplied with tractors and agricultural and forestry machines.

# Operation Manual - MF 400Xtra

---

## Dear Owner

1 - Always keep this Manual in perfect conditions and present it to the technician at the Dealer that attended you in order to note all Warranty Maintenance date.

2 - Please carefully read Chapter 1 for Safety procedures.

3 - The Warranty will only be valid if the tractor's Delivery Certificate is properly registered in AGCO do Brasil Services and Warranty Department.

So, make sure that your Dealer fills out the Delivery Certificate for your tractor.

4 - Tractor's Technical Delivery

It will be performed by a professional at your Dealer.

See the booklet attached to this Manual, where general important information of your interest.

✓ Service Instructions.

✓ Delivery Instructions.

✓ Delivery Certificate.

5 - Changes in the tractors

Due to its policy of constant improvement for its products, AGCO do Brasil reserves the right to introduce changes and improvements in its products, without incurring in any liability or obligation for previously manufactured products.

In the same way, the content of this Manual is updated until the date of its printing and may be changed without previous notice.

6 - Many illustrations in this Manual are shown with covers, protections and components removed for a better comprehension. However, never operate the tractor with these parts removed.

7 - Some pictures may contain different details in relation to the ones showed in your tractor, since they have been taken from prototype tractors or tractors configured with accessories not present in your tractor.

8 - Massey Ferguson Original Parts

The use of parts other than MF original parts may result in a reduced performance of your tractor and also affect some other components.

AGCO do Brasil will not be liable for any responsibility derived from the usage of non-original parts. In case such non-original parts are used during the Terms of the Warranty, the tractor's Warranty will be voided.

9 - Due to the great number of variables in the working conditions, it is not possible for AGCO to contemplate all detailed or definitive instructions on its Publications about the performance or usage methods of its machines, neither AGCO will be responsible for eventual losses or damages arising from such statements or any misstatement or omissions.

If the tractor is used in abnormal conditions - as working in deep water - consult your Massey Ferguson Dealer for special instructions. Otherwise the Warranty will be voided.

These tractors are designed only for usage in regular agricultural operations (designed usage). Any use other than the above stated will not be AGCO do Brasil responsibility: these are solely the user's responsibility.

10 - The accomplishment and the observance, of the usage conditions, maintenance and servicing as stipulated by AGCO do Brasil are the fundamental basis for the "designed usage".

11 - We do insist that these tractors be operated, maintained and repaired only by personnel familiarized with their respective characteristic and safety rules.

So, we strongly recommend that the Customer contacts the nearest Dealer for any problem or question related to the equipment's maintenance or setup.

**<https://www.ebooklibonline.com>**

Hello dear friend!

Thank you very much for reading.

Enter the link into your browser.

The full manual is available for immediate download.

**<https://www.ebooklibonline.com>**

**Content**

<b>Safety Instructions</b>	<b>1</b>
<b>Identification and safety decals</b>	<b>2</b>
<b>Instruments and commands</b>	<b>3</b>
<b>Preparation</b>	<b>4</b>
<b>Operation</b>	<b>5</b>
<b>Maintenance</b>	<b>6</b>
<b>Specifications</b>	<b>7</b>
<b>Accessories</b>	<b>8</b>

Page left blank on purpose.

## Contents

1 - Introduction .....	3
2 - General Recommendations .....	4
3 - The Tractor .....	4
4 - Symbols and Safety Terms .....	4
5 - Notes to the operator .....	5
6 - Follow a safety program .....	5
6.1 - For a proper operation .....	5
7 - Protective Structure Against Overturn (PSAO) .....	6
8 - Preparing for a safety operation .....	7
8.1 - Know your equipment .....	7
8.2 - Protect yourself.....	7
8.3 - Use the safety and protection devices available .....	8
8.4 - Check the equipment .....	8
8.5 - Tractor cleaning .....	9
8.6 - Protect the environment .....	9
9 - Tractor maintenance .....	10
10 - Start .....	10
10.1 - Alert before the start .....	10
10.2 - How to get on and get off the machine safely .....	10
10.3 - Safe start .....	10
10.4 - Follow the start procedures recommended .....	11
10.5 - Test the controls .....	11
10.6 - Start fluid.....	11
11 - Safe operation .....	12
11.1 - Do the correct movements .....	12
11.2 - Safety practices .....	12
11.3 - Overturn risk .....	13
11.4 - To avoid rear overturn .....	14
11.5 - To avoid lateral overturn .....	14
11.6 - Generic risks during the operation .....	15
11.7 - Points about ergonomic behavior .....	16
12 - Additional implements and equipment .....	17
12.1 - Towing equipment .....	18
13 - Transportation on roads .....	18
13.1 - Road rules .....	19
14 - Safety after operation .....	19
15 - Fuel .....	20
15.1 - Storage, handling and cleaning .....	20
15.2 - Specifications .....	21
16 - Parts and lubricants storage .....	22
17 - Quality, Environmental, Safety and Occupational Health Policy .....	22
17.1 - Main guidelines .....	22
17.2 - ISO 14000 .....	23
17.3 - Environmental Management System .....	23
17.4 - Environmental Issues .....	23
17.5 - Recommendations for owners and users of MF tractors .....	24
17.6 - CONAMA Resolution.....	25
17.7 - Risks of the contact with acid solution and with Lead .....	25

# 1. Safety Instructions

---

**1**

## 1 - Introduction

The purpose of this manual is to enable the owner and driver to drive the tractor safely and properly. If the instructions are carefully observed, the tractor will be in operation for many years, following Massey Ferguson's tradition. The configuration and the tractor setup at the Dealer will assure that these operational and service instructions will be correctly understood.

Always contact a Dealer if any part of this Manual is not fully understood. It is essential that these instructions are fully understood and observed.

The daily maintenance must become a routine. Always keep a record of the equipment's service hours.

When requesting new parts, use only MF original parts. MF Dealers network supply original parts and can provide you installation and use instructions. The use of low quality parts can cause severe damages to your equipment.

It is recommended to the customers to purchase service parts only at authorized MF Dealers.

Due to the variation on the operational conditions, it is impossible for the manufactures to make a comprehensive or a definitive statement on its publications related to the performance or ways of use for its equipments, nor be responsible for any damage or losses resulting from such statements, or inaccuracy or omission.

To avoid the possibility of voiding the warranty, consult your MF Dealer about special instructions, if the tractor is to be operated in special conditions, which can be harmful for the equipment (operation in deep waters or swamps, for example). These tractors were designed for use in agricultural applications only (proper use). Any other use will be consider as irregular.

AGCO will not be liable for personal injuries or damages to the equipment resulting from misuse. It will be totally the user's responsibility the consequences for all misuse of the equipment.

The unrestricted commitment and adherence to the operation, services and maintenance requirements, as per specified by AGCO, are considered essential factors for the proper use.

These tractors must be operated and serviced only by qualified personnel, familiarized with the tractor's characteristics and also with the safety rules and regulations (accident prevention).

It is recommended that the customers contact an MF Dealer in case of any after sale problem and for any setup which may be required.

# 1. Safety Instructions

## 1

### 2 - General recommendations

Why is safety so important?

- 1 - Accidents can lead to disabling personal injuries or death.
- 2 - Accidents usually impose onerous costs.
- 3 - Accidents can be avoided.

This Manual describes safety procedures and recommendations related to the tractor, however it does not specify the details about the care with the accessory coupled and/or actuated by the tractor. Therefore, see the Manual of the accessory used.

This Section of the Manual aims to point out some basic safety situations related to your tractor, as well as some suggestions about how to avoid risk and accident situations.

Therefore, the user must be provided with all necessary means and orientation available. For each accessory and working situation, there is always a number of care that must be taken, which makes impossible to list all of them in this Manual.

It is impossible for AGCO do Brasil to make a direct control over all use situations, maintenance or service to which the tractor is submitted to. Therefore, it is the user's responsibility to observe the proper practices aiming his/her safety and the tractor integrity, and also the safety of other people or equipment at the same working area.

### 3 - The Tractor

The tractor is a source of mechanic and hydraulic power.

- The tractor alone has little practical value. Only when used along with an implement or other accessory, it becomes a work unit.
- This Manual has been compiled to cover the safety practices when the tractor is operating under normal conditions.
- This manual does not address the operation instructions relevant to all implements and accessories known that can be installed at the tractor delivery or any other date.
- It is essential that the operator read and understand the manuals of the relevant implements and accessories.

### 4 - Symbols and Safety Terms

The following symbol means: ATTENTION! BE AWARE! YOU MAY BE IN DANGER!



The symbol for safety alert identifies important safety messages in machines, safety boards, manuals, etc. When you see the symbol, be aware for potential injuries or death. Follow the instructions in the safety message.

Whenever you see one of the words and symbols below, used in this Operator's Manual and decals, you must pay careful attention to the instructions, once they are directly connected to your personal safety.



**WARNING:**

*Indicates an immediate hazardous situation which, if not avoided, will result in DEATH OR SERIOUS INJURY.*



**CAUTION!**

*Indicates a potential immediate hazardous situation which, if not avoided, will result in DEATH OR SERIOUS INJURY.*



**CAUTION:**

*Indicates a potential hazardous situation which, if not avoided, may result in minor or moderate injury.*

The following words and instructions are not directly related to personal safety, but they are not used by this manual bringing you additional tips about operation and service of this equipment.



**IMPORTANT:**

*they identify special instructions or procedure which, if not carefully observed, can result in damages or destruction to the equipment, the operational process or even to objects nearby.*



**NOTE:**

*It indicates additional information about some subject or procedure that will make the operation or repair more convenient or efficient.*

## 5 - Notes to the operator

It is your responsibility to read and understand the Safety Section in this Manual, before using the equipment. You must follow the safety instructions which will guide you step by step during your working journey.

Remember that you are an essential part to make the operation of the machine safe. Good safety practices not only protect you, but also the people near you. Carefully read the safety instructions herein and include them in your safety program.

Remember that this Safety Section was specially designed for this equipment. Follow all usual and habitual safety precautions and, above of all else, REMEMBER THAT YOUR SAFETY DEPENDS ONLY OF YOU. YOU CAN PREVENT ACCIDENTS.

## 6 - Follow a safety program

### 6.1 - For a proper operation

For a proper operation of the tractor, it must be operated by qualified and authorized staff. In order to be qualified, you must understand the instructions delivered in this Manual, receive proper training and know the safety standards and rules related to your work. For example, some traffic rules determine that people under age 16 years old are not allow to operate agricultural machines. In other locations, the law determines that only 18-year-old people are allowed. The tractors are part of this category. It is your responsibility to know such rules and obey them.

These regulations include, but they are not limited to, the following instructions for a safe operation:



#### CAUTION!

*The operator must not drink alcoholic drinks or substances that may affect his consciousness or coordination. If the operator is taking prescription drugs or over the counter drugs, he must see a doctor in order to check if his ability to operate the machine may be impaired by such drug.*



#### CAUTION:

*If any implement or kit used has a manual, identify if there is other important safety information.*

Observe the following instructions:

- DO NOT allow children or people non qualified for the job operate the tractor. Keep people away from the work area.
- Always use the safety belt.
- Whenever possible, avoid operating the tractor near ditches, barriers or holes. Reduce the speed in curves, when going up or down hills or on rough, slippery or muddy surfaces.
- Avoid very steep hills.
- Pay careful attention to where you are going to, mainly at the end of aisles, roads or when operating near trees.
- The instructor's seat must be used for short periods only.
- DO NOT allow children on the instructor's seat.
- DO NOT give ride to anyone on the machine or implement, unless there is a proper instructor's seat.
- The implement must only be coupled to the steering rod or to the coupling points recommended and never above the central line of the rear shaft.
- Operate the tractor slowly and carefully - with no maneuvers, sudden starts or sudden breaking. When the tractor is stopped, engage the parking break. Lower the implement and take the starting key from the ignition.
- DO NOT change or remove any part from the equipment and DO NOT use accessories that are not suitable for the tractor.

## 1. Safety Instructions

# 1

### 7 - Protective Structure Against Overturn (PSAO)

The tractor has been mounted with a PSAO (Fig. 3) or cab and a safety belt. PSAO is effective to reduce potential harms or injuries during the overturn if the safety belt is being used correctly. Do not operate the tractor with the PSAO removed.

Before using the tractor, make sure that the PSAO or cab are not damaged, and that they are safely fixed to the tractor and, if the portable type is installed, make sure it is in the extended position and safely locked.

If for any reason, the PSAO has been folded, it must return to the extended position as soon as the conditions allow.

Do not mount additional components to the PSAO or cab, such as chains, ropes or cables with the purpose of pulling something, because it may cause displacement or damages to the PSAO.

Always use the safety belt, adjusting it properly (Fig. 4), except when operating the PSAO retracted. Check the safety belt for damages regularly. Damaged safety belt must be replaced.

The PSAO or cab must be inspected for damages regularly. Any damaged component must be replaced before the tractor is operated. If the PSAO is damaged during an overturn or damaged by the impact from any object that provokes deformation must be replaced. Do not try to repair a damaged PSAO.

NEVER weld or puncture the PSAO or structure of the cab, for any reason, because it may lead to failures and reduction on the protection for the structure.

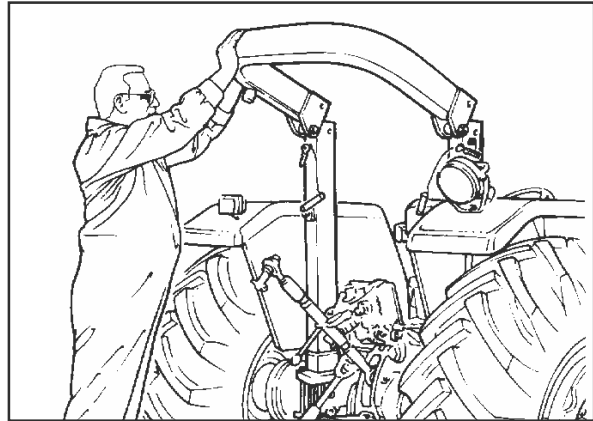

Fig. 3

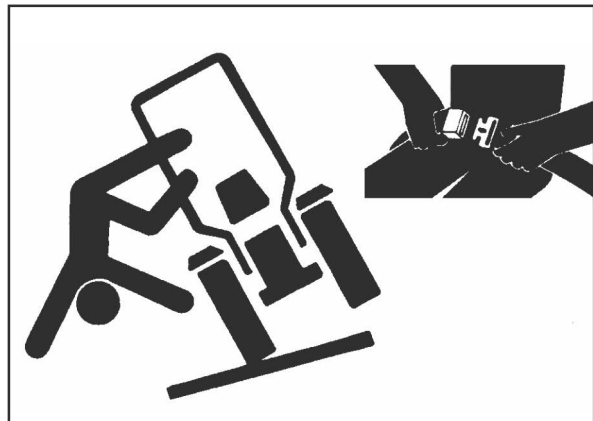

Fig. 4

## 8 - Preparing for a safe operation

### 8.1 - Know your equipment

Know your tractor, know how to operate every

equipment of your machine and the implements and accessories it uses. Know all functions of all controls, gauges, instruments and commands. Know the rated load capacity, the speed range, the breaking capacity and the steering characteristics of the machine, besides the turning radius and operations clearances. Remember that rain, snow, gravel, soft soil, etc. may affect the tractor operation.

Under bad conditions of operation, drive slower and be more careful. Engage the front drive, if equipped. Study the safety decals for DANGER, WARNING, PRECAUTION or CAUTION located on the tractor, in addition to the information decal.

**READ THIS MANUAL BEFORE STARTING THE ENGINE. STUDY IT BEFORE STARTING WORKING (Fig. 5). IF YOU DO NOT UNDERSTAND ANY INFORMATION IN THIS MANUAL, ASK SOMEBODY TO EXPLAIN TO YOU.**

This Manual covers all generic safety practices for agricultural tractors. It must always be kept in the tractor. If additional copies of this Manual are required, contact your MF Dealer.



Fig. 5

### 8.2 - Protect yourself

Use equipments and protective clothing appropriate for your work. 6). Do not take risks.

You will need:

- A protective hard hat.
- Protective goggles or masks.
- Ear protection.
- Respirator or filter mask.
- Special clothing for cold weather.
- Reflective clothing.
- Heavy gloves (neoprene for chemicals or leather for heavy duty).
- Boots.

**DO NOT** wear loose clothing, jewel, or any other item that might get caught in the controls or other parts in the tractor. Also, tie your hair if it is long.

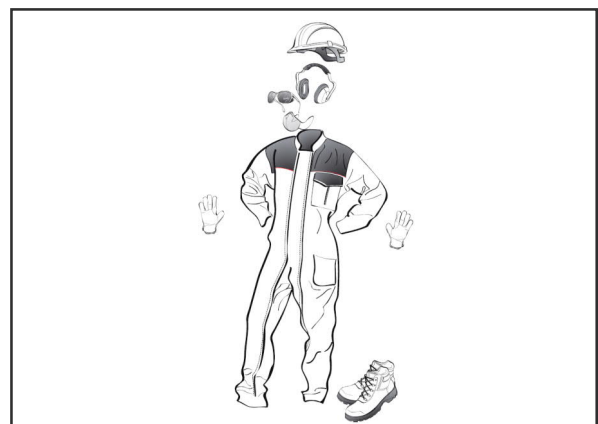

Fig. 6

# 1. Safety Instructions

1

Note the position of fire extinguishers and first aid kits (Fig. 7) and be aware of where to find assistance in case of an emergency. Know your equipment well and know how to use it.

## 8.3 - Use the safety and protection devices available

Keep all the protection devices in the position and properly attached. Make sure that all protections and covers are properly installed, as specified, and in good conditions.

In order to keep you and other people safe, the tractor must be equipped with:

- Safety belt.
- PTO protection.

According to the type of operation, the tractor may also need:

- Rearview mirror.
- Fire extinguisher.
- Safety triangle, protections, reverse gear alarm, lighting and additional safety decals.

It is very important to know how to use the tractor safety devices. Make sure they are in the position and in good conditions. **DO NOT** remove or disconnect any safety device.

## 8.4 - Check the equipment

Before starting your working day, reserve some time to check your equipment and make sure all systems are in good operational conditions.

- **DO NOT** smoke while refilling the tractor. Keep away from flames (Fig. 8).
- Stop the engine and wait it cools before refilling the tractor.
- Check for damaged, cracked, loose or missing parts. Keep all parts in good condition. Make sure all guards, protections and covers are in place.
- Check the safety belt for damages regularly. If the belt is damaged, it must be replaced.
- Make sure the implements and accessories are correctly installed and that the tractor PTO speed and implement are correct.
- Check the condition and calibration of tires (absence of cuts and bulges). Replace damaged or worn tires. Check if the parking break and pedal are working correctly. Adjust them if necessary.

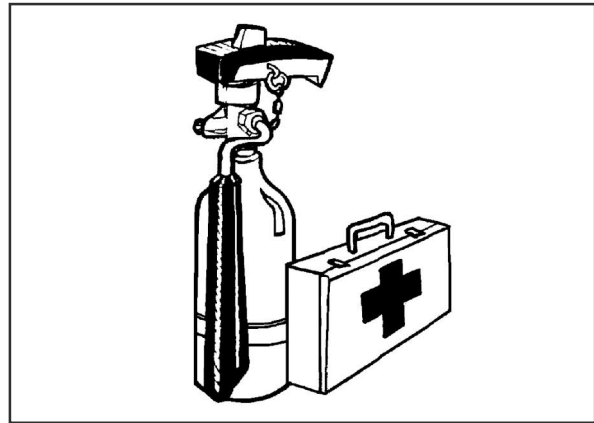

Fig. 7



Fig. 8

- Make sure the safety devices of the PTO shaft are locked.
- Make sure that the PTO protection and the shaft protections are in place and working properly.
- Check the hydraulic system of the implement and tractor. Repair or replace damaged or missing parts.

# 1. Safety Instructions



## CAUTION!

*Pressurized hydraulic fluid or diesel leak can penetrate in your skin and cause severe personal injuries, blindness or even death. Pressurized fluid leaks may not be visible. Use a carton board or wood to find the leaks. DO NOT place your hands directly to the equipment. Always wear protective goggles. If the fluid penetrates in your skin, it must be surgically removed within a few hours by a physician familiarized with such procedure (Fig. 9).*

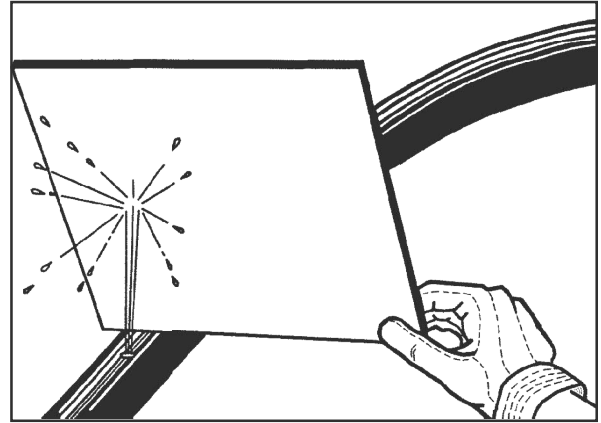

Fig. 9

1

Before applying pressure to the fuel or the hydraulic system, make sure that all connections are well fit and all tubing, pipes and hoses are in good conditions. Before disconnecting the hydraulic or fuel lines, relieve all pressure. Make sure that all hydraulic lines are correctly installed and without bents.



## CAUTION!

*The cooling systems accumulate pressure as the engine warms. Before removing the radiator cap, stop the engine and wait the system cool down.*

## 8.5. Tractor cleaning

- Keep the working surfaces and engine compartments clean.
- Before cleaning the machine, always lower the implements to the ground level, set the transmission to neutral, engage the parking brake, stop the engine and remove the starting key from the ignition.
- Clean the steps, the pedals and operator platform. Remove the grease or oil. Clean all dust or mud off. In the winter, remove the snow or ice. Remember: slippery surfaces are dangerous.
- Remove and store the tools, chains or hooks.

## 8.6 - Protect the environment

It is illegal to pollute sewer, brooks or soil. The waste must be sent to authorized places, away from urban or preservation areas. Furthermore, the dirty oil removed from the tractor must be packed in proper containers before being disposed. If you have any question, see the local authorities.

# 1. Safety Instructions

## 9. Tractor maintenance

- DO NOT make any repair or maintenance service with the engine running or still hot, or with the tractor in operation (Fig. 10).
- Before making adjustments or repair the electric system, disconnect the battery cables: first, disconnect the negative (-) cable.
- To prevent fire or explosions keep flames away from the battery or from the cold start devices. To prevent sparks, that can cause explosions, use jumper cables according to the instructions in this manual.
- When performing repairs or adjustments, it is recommended to contact a Massey Ferguson Dealer so the work can be performed by trained personnel.
- The implement and/or tractor must be placed on wood blocks or proper stands, NEVER on a hydraulic jack.
- Check all nuts and bolts for tightening periodically, mainly the hub wheel nuts and the wheel ring nuts. Fasten them according to the specified torque.



Fig. 10

## 10 - Start

### 10.1 - Alert before the start

Before starting the engine, walk around the tractor and the implement coupled. Make sure there is nobody under, on or near the machines. Tell people near the tractor you will start it soon. Do not start the tractor while there are people around the tractor, implements or towed equipment.

Make sure all pedestrians, mainly children, are at a reasonable distance before starting the engine.

### 10.2 - How to get on and get off the machine safely

Always adopt the “three-point contact” with the machine and keep a front position when getting on it. The three-point contact means both hands and one foot or one hand and two feet in contact with the machine, all the time, when getting on or off it.

Clean your shoes and wash and dry your hands before getting on the machine. Use the handrail. Hold the handrails and always use the stairs or steps when getting on or off the machine.

DO NOT use the control levers as a handrail and never step on the pedal controls when getting on or off the

machine.

DO NOT try to get on or off when the tractor is running.  
DO NOT jump off the tractor, unless it is an emergency.

### 10.3 - Safe start



#### **IMPORTANT:**

*Before starting the engine, make sure there is enough ventilation. DO NOT start the engine in closed environments. The smoke from the engine may cause suffocation.*

Always start the engine from the operator seat with all transmission levers in neutral and the PTO lever in neutral.

Make sure all the brake pedals are always locked by the locking device, except when in maneuvers in the field which requires the independent use of brakes. Make sure the brakes are properly regulated, so that both brakes are engaged at the same time.

# 1. Safety Instructions

1

Adjust the seat, put on the safety belt, engage the parking brake and set all controls to neutral before starting.



**WARNING!**

*Start the engine with the starting key and always sitting on the operator seat. NEVER try to start the engine by a direct start.*

*The machine will start engaged if the safety switch circuit is turned. This may cause severe injuries or death if there is someone near the tractor (Fig. 11).*



Fig. 11

## 10.4 - Follow the start procedures recommended

Follow the start procedures recommended in the Operation Section in this Manual. Such procedures include normal start, cold start and the usage of boost fluids.

## 10.5 - Test the controls

After starting the machine, check all meters and lights again. Make sure everything is working properly. If the tractor does not respond correctly when every control is activated, DO NOT use the machine until the problem is solved. Make sure engine start solenoid cover is always in place.

## 10.6 - Start fluid



**CAUTION!**

*It is very important that you read and follow all the instructions on the ether can before installing the ether base cold start aid in the tractor.*

For tractors equipped with glow plugs or preheating system, these pieces of equipment must be removed before installing an ether start device.

DO NOT use aerosol packages of start fluids in tractors equipped with the reheating system connected to the electrical system. Ether combined with the preheating system may cause explosions, damaging the engine, provoking injury to whoever is handling it or both. Handle the start fluid correctly. The start fluid must only be used when the ether start aid is used as original default equipment or when installed as accessory by the Dealer.



Fig. 12



**Suggest:**

**For more complete manuals. Please go to the home page.**

**<https://www.ebooklibonline.com>**

**If the above button click is invalid. Please download this document first, and then click the above link to download the complete manual.**

**Thank you so much for reading**

# 1. Safety Instructions

1

If start fluid aerosol cans or ether start aid is used, the preheating system must be disconnected. Remove the cable from the preheating system unit that is found in the intake manifold. Use isolating tape on the cable end to avoid short circuit.

## 11 - Safe operation



### CAUTION!

*An unbalanced tractor can overturn and cause serious accidents.*

Make sure the counterweights in the front frame, the wheel weights and wheel ballasts are used according to the manufacturer's recommendations. DO NOT add extra weight to make up for an overloaded tractor. It is recommended to reduce the load. Keep all your limbs inside the operator compartment while operating the tractor.

### 11.1 - Do the correct movements

Make sure the tractor is ready for the work to be done. Know its rated load capacities and never exceed the numbers. Make sure that the equipment or implement used DO NOT exceed the tractor load capacity. Make sure the tractor PTO and the implement PTO are compatible.

Remember that the tractors normally operate on rough, unpaved or bumpy surfaces. The operating conditions can reduce the weight quantity that you can carry or tow.

### 11.2 - Safety practices

- Operate the controls carefully. Do not turn the steering or make sudden movements to activate other controls.
- DO NOT get on or off the tractor when it is in operation. Hold the steering wheel with both hands and firmly.
- Make sure there is enough room in all directions, for the tractor and the implement as well.
- DO NOT play with the tractor or equipment. They must be used for the purpose indicated only.

- DO NOT try to activate the controls if you are not on the operator's seat.
- Before getting off the tractor, always disengage the PTO, lower the accessories and the implements to the ground, set the tractor to neutral, engage the parking brake, stop the engine and remove the key from the ignition.

**Be alert!** If anything breaks down, get loose or fail in the equipment, stop working, inspect the machine and make the necessary repairs before starting the operation again.

### Be careful with pedestrians

Be attentive to what is going on around you. DO NOT allow not trained or not qualified operate the tractor. They can cause serious accidents.



### WARNING!

*DO NOT give ride on the machine or implement (Fig. 13).*

DO NOT allow that other people ride the implement or other equipment, such as wagons, except for some cropping equipment which are specially designed for passengers during the cropping operations (not during transportation). There must be some space in such equipment, so such type of transportation can be done safely. DO NOT allow children on the tractor.



Fig. 13

# 1. Safety Instructions

1

- Make sure you can control both the machine speed and the steering before starting it. Move the machine slowly until everything is working properly. After the start, check the steering angle again - to the right and to the left. Make sure you can move the machine both to the right and to the left and can control the machine completely. If the differential is blocked, DO NOT operate or maneuver the tractor in high speed until the differential is unlocked.
- DO NOT lift objects that do not fit in the bumper. Purchase the correct equipment.
- DO NOT lift loads over other people.
- Keep people away from the working area. DO NOT allow other people to stay or pass under an implement lifted (Fig. 14).
- If a charger is used, avoid sudden stops, starts or maneuvers, or sudden changes of direction. Keep the loads close to the ground during the transportation.
- NEVER stop (or allow other to stop) in front of, under or behind loaded equipment or equipment being loaded. DO NOT drive the tractor towards someone standing in front of a fixed object.
- Keep people away from the yokes, couplings, steering rod, lift arms, PTO driving parts, cylinders, belts, pulleys and other moving parts. Keep all protections and guards in their places.

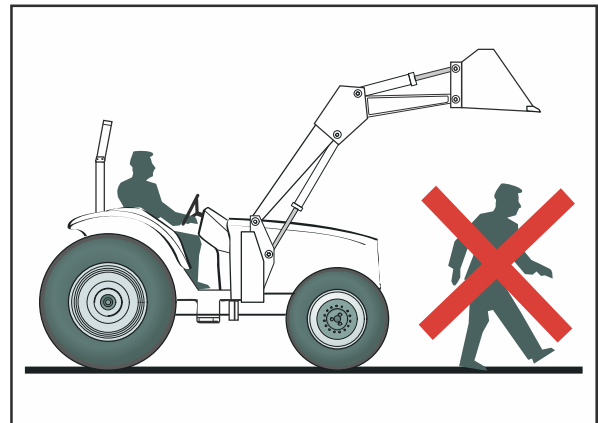

Fig. 14



## CAUTION!

*DO NOT stand nor allow anyone to stand between the tractor and the implement, unless the engine is off, the parking brake is applied, the transmission is in Neutral and all accessories are lowered to the ground level.*

## 11.3 - Overturn risk

If a tractor equipped with PSAO overturns, hold the steering wheel firmly and DO NOT try to get off the seat until the tractor stops completely and DO NOT leave the operator's seat until the tractor stops completely (Fig. 15 ). If the cab doors are blocked, leave the tractor through the rear window or roof hatchway.

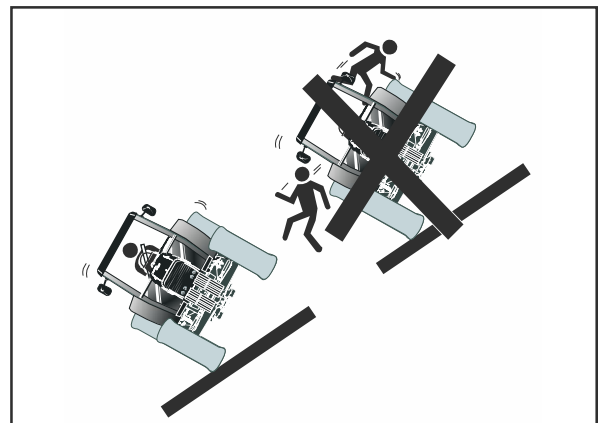

Fig. 15

**<https://www.ebooklibonline.com>**

Hello dear friend!

Thank you very much for reading.

Enter the link into your browser.

The full manual is available for immediate download.

**<https://www.ebooklibonline.com>**