

Product: BACKHOE LOADER

Model: 428F BACKHOE LOADER RAK

Configuration: 428F Backhoe Loader Side Shift RAK00001-UP (MACHINE) POWERED BY C4.4 Engine

## **Operation and Maintenance Manual 428F, 432F, 434F and 444F Backhoe Loaders**

Media Number -SEBU8716-03

Publication Date -01/10/2013

Date Updated -09/10/2013

s00037320

## **Foreword**

### **Literature Information**

This manual should be stored in the operator's compartment in the literature holder or seat back literature storage area.

This manual contains safety information, operation instructions, transportation information, lubrication information and maintenance information.

Some photographs or illustrations in this publication show details or attachments that can be different from your machine. Guards and covers might have been removed for illustrative purposes.

Continuing improvement and advancement of product design might have caused changes to your machine which are not included in this publication. Read, study and keep this manual with the machine.

Whenever a question arises regarding your machine, or this publication, please consult your Cat dealer for the latest available information.

## **Safety**

The safety section lists basic safety precautions. In addition, this section identifies the text and locations of warning signs and labels used on the machine.

Read and understand the basic precautions listed in the safety section before operating or performing lubrication, maintenance and repair on this machine.

## **Operation**

The operation section is a reference for the new operator and a refresher for the experienced operator. This section includes a discussion of gauges, switches, machine controls, attachment controls, transportation and towing information.

Photographs and illustrations guide the operator through correct procedures of checking, starting, operating and stopping the machine.

Operating techniques outlined in this publication are basic. Skill and techniques develop as the operator gains knowledge of the machine and its capabilities.

## Maintenance

The maintenance section is a guide to equipment care. The Maintenance Interval Schedule (MIS) lists the items to be maintained at a specific service interval. Items without specific intervals are listed under the "When Required" service interval. The Maintenance Interval Schedule lists the page number for the step-by-step instructions required to accomplish the scheduled maintenance. Use the Maintenance Interval Schedule as an index or "one safe source" for all maintenance procedures.

### Maintenance Intervals

Use the service hour meter to determine servicing intervals. Calendar intervals shown (daily, weekly, monthly, etc.) can be used instead of service hour meter intervals if they provide more convenient servicing schedules and approximate the indicated service hour meter reading. Recommended service should always be performed at the interval that occurs first.

Under extremely severe, dusty or wet operating conditions, more frequent lubrication than is specified in the maintenance intervals chart might be necessary.

Perform service on items at multiples of the original requirement. For example, at every 500 service hours or 3 months, also service those items listed under every 250 service hours or monthly and every 10 service hours or daily.

## California Proposition 65 Warning

Diesel engine exhaust and some of its constituents are known to the State of California to cause cancer, birth defects, and other reproductive harm.

Battery posts, terminals and related accessories contain lead and lead compounds. **Wash hands after handling.**

## Certified Engine Maintenance

Proper maintenance and repair is essential to keep the engine and machine systems operating correctly. As the heavy duty off-road diesel engine owner, you are responsible for the performance of the required maintenance listed in the Owner Manual, Operation and Maintenance Manual, and Service Manual.

It is prohibited for any person engaged in the business of repairing, servicing, selling, leasing, or trading engines or machines to remove, alter, or render inoperative any emission related device or element of design installed on or in an engine or machine that is in compliance with the regulations (40 CFR Part 89). Certain elements of the machine and engine such as the exhaust system, fuel system, electrical system, intake air system and cooling system may be emission related and should not be altered unless approved by Caterpillar.

## Machine Capacity

Additional attachments or modifications may exceed machine design capacity which can adversely affect performance characteristics. Included would be stability and system certifications such as brakes, steering, and rollover protective structures (ROPS). Contact your Cat dealer for further information.

## Cat Product Identification Number

Effective First Quarter 2001 the Cat Product Identification Number (PIN) has changed from 8 to 17 characters. In an effort to provide uniform equipment identification, Caterpillar and other construction equipment manufacturers are moving to comply with the latest version of the product identification numbering standard. Non-road machine PINs are defined by ISO 10261. The new PIN format will apply to all Cat machines and generator sets. The PIN plates and frame marking will display the 17 character PIN. The new format will look like the following:



---

Illustration 1

g00751314

Where:

1. Caterpillar's World Manufacturing Code (characters 1-3)
2. Machine Descriptor (characters 4-8)
3. Check Character (character 9)
4. Machine Indicator Section (MIS) or Product Sequence Number (characters 10-17). These were previously referred to as the Serial Number.

Machines and generator sets produced before First Quarter 2001 will maintain their 8 character PIN format.

**<https://www.ebooklibonline.com>**

Hello dear friend!

Thank you very much for reading.

Enter the link into your browser.

The full manual is available for immediate download.

**<https://www.ebooklibonline.com>**

Components such as engines, transmissions, axles, etc. and work tools will continue to use an 8 character Serial Number (S/N).

---

Product: BACKHOE LOADER

Model: 428F BACKHOE LOADER RAK

Configuration: 428F Backhoe Loader Side Shift RAK00001-UP (MACHINE) POWERED BY C4.4 Engine

## Operation and Maintenance Manual 428F, 432F, 434F and 444F Backhoe Loaders

Media Number -SEBU8716-03

Publication Date -01/10/2013

Date Updated -09/10/2013

i05001131

### Safety Messages

SMCS - 7000; 7405

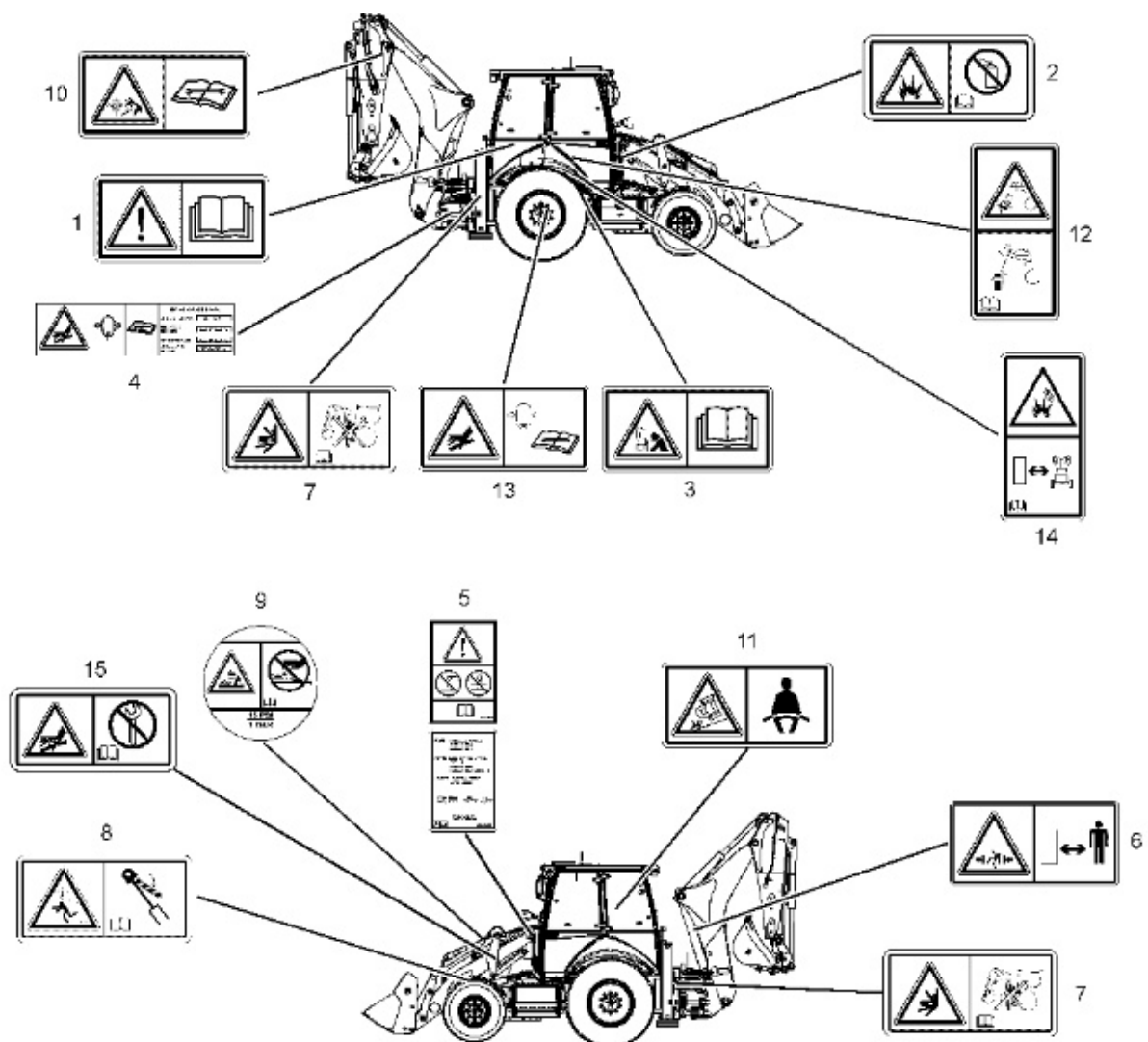

Illustration 1

g03176999

There are several specific safety messages on this machine. The exact location of the hazards and the description of the hazards are reviewed in this section. Please become familiarized with all safety messages.

Make sure that all of the safety messages are legible. Clean the safety messages or replace the safety messages if you cannot read the words. Replace the illustrations if the illustrations are not legible. When you clean the safety messages, use a cloth, water, and soap. Do not use solvent, gasoline, or other harsh chemicals to clean the safety messages. Solvents, gasoline, or harsh chemicals could loosen the adhesive that secures the safety message. Loose adhesive will allow the safety message to fall.

Replace any safety message that is damaged, or missing. If a safety message is attached to a part that is replaced, install a safety message on the replacement part. Any Caterpillar dealer can provide new safety messages.

### Do Not Operate (1)

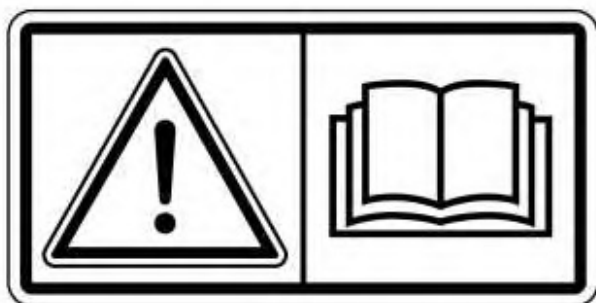

---

Illustration 2

g01370904

This safety message is located under the engine start switch.

 **WARNING**

**Do not operate or work on this machine unless you have read and understand the instructions and warnings in the Operation and Maintenance Manuals. Failure to follow the instructions or heed the warnings could result in injury or death. Contact your Cat dealer for replacement manuals. Proper care is your responsibility.**

---

### No Ether In Air Inlet (2)

---



Illustration 3

g01372254

This safety message is located on the air filter cover.

**! WARNING**

**If equipped with an air inlet heater (AIH) for cold weather starting, do not use aerosol types of starting aids such as ether. Such use could result in an explosion and personal injury.**

**Proper Connections for Jump Start Cables (3)**



Illustration 4

g01370909

This safety message is located on the inside of the door for the battery compartment.

**! WARNING**

**Explosion Hazard! Improper jumper cable connections can cause an explosion resulting in serious injury or death. Batteries may be located in separate compartments. When using jump start cables, always**

connect the positive (+) cable from the source to the positive (+) terminal of the battery that is connected to the starter solenoid. Connect the negative (-) cable from the source to the negative (-) terminal of the starter. If the machine is not equipped with a starter negative terminal, connect the negative (-) cable to the engine block. Follow the procedure in the Operation and Maintenance Manual.

---

#### High Pressure Accumulator (4)

This safety message is located on the accumulator for the pilot operated hydraulic controls. This accumulator is located on the frame on the right rear of the machine.

---



g01374065

### **WARNING**

Hydraulic accumulator contains gas and oil under high pressure. Improper removal or repair procedures could cause severe injury. To remove or repair, instructions in the service manual must be followed. Special equipment is required for testing and charging.

---

#### ROPS (5)

---



Illustration 5

g01113333

This safety message is located on the cab next to the left side door.



**Structural damage, an overturn, modification, alteration, or improper repair can impair this structure's protection capability thereby voiding this certification. Do not weld on or drill holes in the structure. Consult a Caterpillar dealer to determine this structure's limitations without voiding its certification.**

**Crush Hazard (6)**



Illustration 6

g01371644

This safety message is located on the boom above the boom foot pin.



**Crushing Hazard! Stay back a safe distance. There is no clearance for a person in this area when the machine turns. Failure to follow these instructions could cause serious injury or death.**

### No Exit (7)



Illustration 7

g01407377

This safety message is located on the back of the cab.



**Crush hazard; This is not an entrance or exit. Stay clear of this area when the machine is operating. Start and operate the backhoe from the**

**operator seat only. Failure to follow these warnings could result in injury or death.**

---

### **Brace The Lift Cylinder (8)**



Illustration 8

g01407376

This safety message is located on the brace for the loader lift arm.

## **! WARNING**

**When performing any work underneath a raised loader lift arm, the loader lift arm brace must be in place. Install the loader lift arm brace as follows.**

- 1. Empty loader bucket. Remove pin that secures loader lift arm brace to left loader arm. Raise the loader arms with the bucket in the dump position.**
- 2. Position service brace over left lift cylinder with flat end against cylinder end.**
- 3. Push pin through holes of loader lift arm brace and install cotter pin.**
- 4. Slowly lower loader arms until brace contacts the top of the lift cylinder and bosses on loader arm.**
- 5. To remove loader lift arm brace, reverse procedure.**

**Failure to follow this procedure can result in death or serious injury if the loader arms are accidentally lowered.**

---

Refer to Operation and Maintenance Manual, "Lift Cylinder Brace - Connect and Disconnect" for more information.

### Pressurized System (9)

This safety message is located on the cooling system filler cap.



g01370913



**Pressurized system: Hot coolant can cause serious burn. To open cap, stop engine, wait until radiator is cool. Then loosen cap slowly to relieve the pressure.**

---

### High Cylinder Pressure (10)

This safety message is located on both sides of the boom near the connection with the stick.



g01407379

**! WARNING**

**High Pressure Cylinder. Failure to read and follow these instructions can cause rapidly discharging gas and/or hydraulic fluid which can result in death, personal injury and property damage.**

---

**Seat Belt (11)**



Illustration 9

g01370908

This safety message is located under the engine start switch.

**! WARNING**

**A seat belt should be worn at all times during machine operation to prevent serious injury or death in the event of an accident or machine overturn. Failure to wear a seat belt during machine operation may result in serious injury or death.**

---

**Quick Coupler (12) (If Equipped)**

This safety message is located in the front of the cab on the right side.

---



---

g01411137

 **WARNING**

**CRUSH INJURY. COULD CAUSE SERIOUS INJURY OR DEATH.  
ALWAYS CONFIRM QUICK COUPLER PINS ARE ENGAGED.  
REFER TO THE OPERATION AND MAINTENANCE MANUAL**

---

### High Pressure Accumulator (13)

This safety message is located next to the accumulator if the machine is equipped with the option for ride control. The accumulator is located behind the battery box.

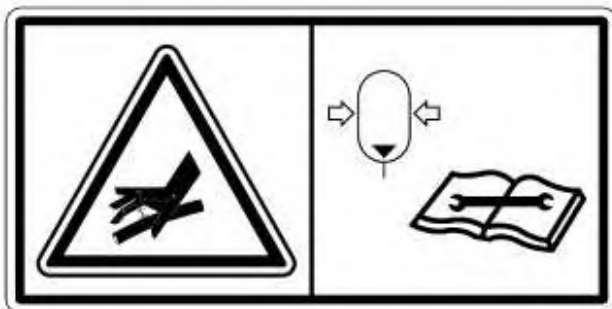

---

g01370912

 **WARNING**

**Hydraulic accumulator contains gas and oil under high pressure. Improper removal or repair procedures could cause severe injury. To remove or repair, instructions in the service manual must be followed. Special equipment is required for testing and charging.**

---

### **Product Link (14) (If Equipped)**

This safety message is located in the front of the cab on the left post.



g01381177

## **⚠ WARNING**

**This machine is equipped with a Caterpillar Product Link communication device. When electric detonators are used, this communication device should be deactivated within 12 m (40 ft) of a blast site for satellite-based systems and within 3 m (10 ft) of a blast site for cellular based systems, or within the distance mandated under applicable legal requirements. Failure to do so could cause interference with blasting operations and result in serious injury or death.**

**In cases where the type of Product Link module cannot be identified, Caterpillar recommends that the device be disabled no less than 12 m (40 ft) from the blast perimeter.**

---

### **High Pressure Fuel (15)**

---



---

Illustration 10

g01381180

This safety message is located on the fuel rail on the top of the engine.

 **WARNING**

**Do not loosen any high pressure fuel lines when the engine is running.  
The high pressure in the fuel lines can cause personal injury or death.  
Wait 60 seconds after the engine has stopped to allow pressure to purge  
before any service or repair is performed on the engine fuel lines.**

---

Product: BACKHOE LOADER

Model: 428F BACKHOE LOADER RAK

Configuration: 428F Backhoe Loader Side Shift RAK00001-UP (MACHINE) POWERED BY C4.4 Engine

## **Operation and Maintenance Manual 428F, 432F, 434F and 444F Backhoe Loaders**

Media Number -SEBU8716-03

Publication Date -01/10/2013

Date Updated -09/10/2013

i05391116

## **Additional Messages**

SMCS - 7000; 7405

---

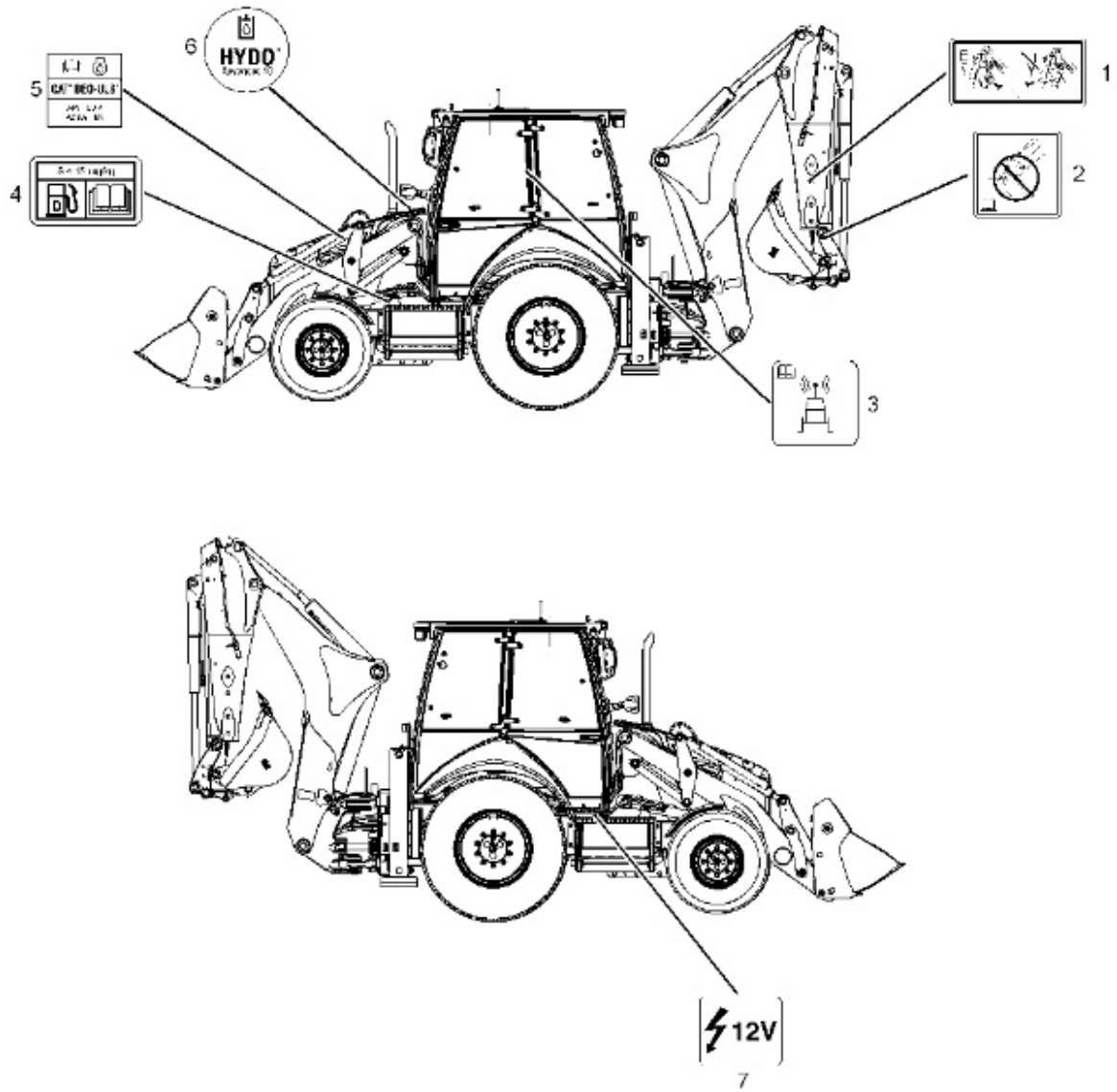
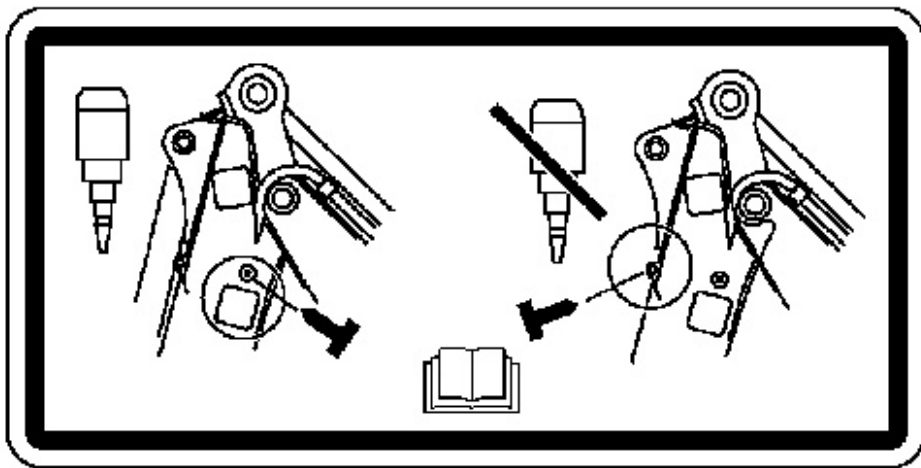

Illustration 1

g03408204

**Pinning of the Extendable Stick (1)**

If equipped, this message is located on the stick.



---

Illustration 2

g01202535

**⚠ CAUTION**

**The E-Stick must be pinned before using attachments, to prevent movement which could cause personal injury.**

---

### **Improper Location of the Backhoe Bucket (2)**

This message is located by the linkage for the backhoe bucket.

---

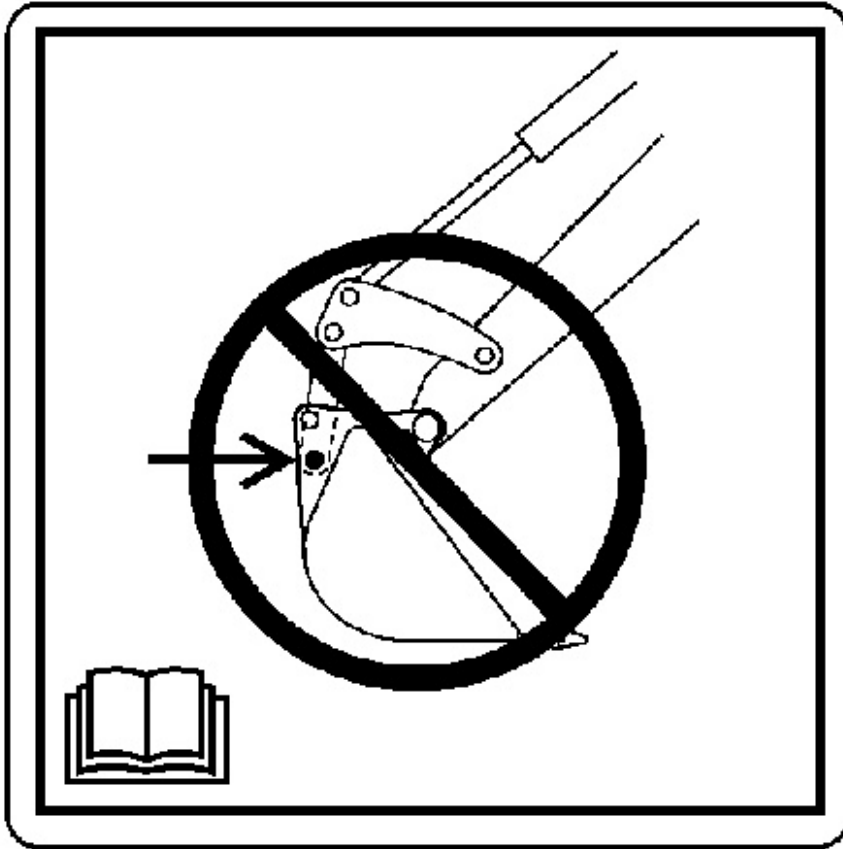

Illustration 3

g01202537



**Improper bucket pin connection can cause machine damage. Make sure the bucket pins are connected properly.**

### Data Privacy (3)

This message is located in the cab.



**Diesel Fuel Recommendations (4)**

This message is located next to the fuel fill.

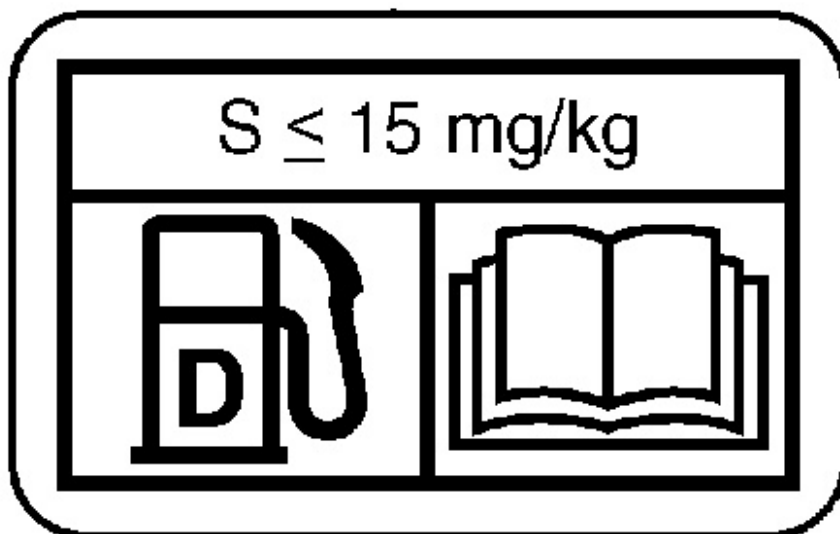

Use Ultra Low Sulfur Diesel (ULSD) fuel.

The United States (U.S.) Environmental Protection Agency (EPA) defines Ultra-Low Sulfur Diesel (ULSD - S15) as a U.S. diesel fuel with a sulfur content not to exceed 15 parts per million (ppm (mg/kg)) or 0.0015 percent by weight. Engines certified to nonroad Tier 4 standards (Stage IV in Europe) and are equipped with exhaust aftertreatment systems are designed to run on ULSD only. Use of LSD or fuels higher than 15 ppm (mg/kg) sulfur in these engines will reduce engine efficiency and engine durability and will damage emissions control systems and/or shorten the service interval. Failures that result from the use of fuels are not Cat factory defects. Therefore the cost of repairs would not be covered by a Cat warranty.

In Europe, ultra low sulfur diesel fuel will have a maximum of 0.0010 percent (10 ppm(mg/kg)) sulfur and is typically referred to as "sulfur-free". This sulfur level is defined in European Standard "EN 590:2004".

Refer to Special Publication, SEBU6250, "Caterpillar Machine Fluids Recommendations" for more information about diesel fuels and sulfur.

Refer to Operation and Maintenance Manual, "Capacities (Refill)".

**Required Engine Oil (5)**

This message is located on top of the engine on the left side of the machine.

---

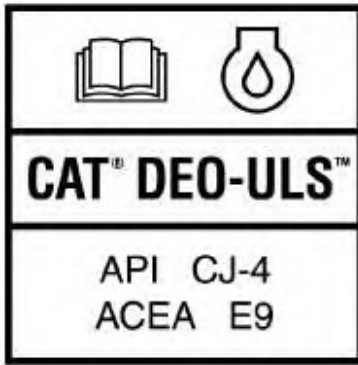

---

Illustration 6

g02176761

### Machine Hydraulic System (6)

The following message is located in the engine compartment.



---

Illustration 7

g02096113

This machine hydraulic system is filled with Cat HYDO Advanced oil. The following message is located in the engine compartment.

Refer to Operation and Maintenance Manual, "Lubricant Viscosities" for more information about the hydraulic oil.

### 12 V (7)

The following message is located on the right side of the machine below the door.

---

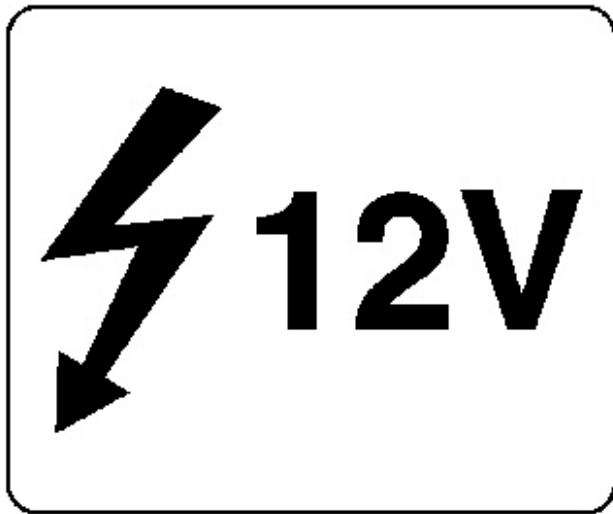

---

Illustration 8

g03407930

---



**Suggest:**

**For more complete manuals. Please go to the home page.**

**<https://www.ebooklibonline.com>**

**If the above button click is invalid. Please download this document first, and then click the above link to download the complete manual.**

**Thank you so much for reading**

Product: BACKHOE LOADER

Model: 428F BACKHOE LOADER RAK

Configuration: 428F Backhoe Loader Side Shift RAK00001-UP (MACHINE) POWERED BY C4.4 Engine

## Operation and Maintenance Manual 428F, 432F, 434F and 444F Backhoe Loaders

Media Number -SEBU8716-03

Publication Date -01/10/2013

Date Updated -09/10/2013

i07500894

## General Hazard Information

SMCS - 7000

---

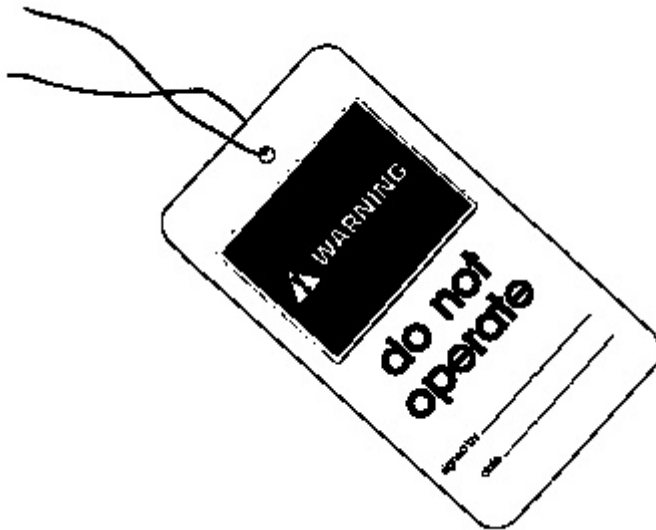

---

Illustration 1

g00104545

Typical example

Attach a "Do Not Operate" warning tag or a similar warning tag to the start switch or to the controls. Attach the warning tag before you service the equipment or before you repair the equipment. Warning tag SEHS7332 is available from your Cat dealer.



**Operating the machine while distracted can result in the loss of machine control. Use extreme caution when using any device while operating the**

**machine. Operating the machine while distracted can result in personal injury or death.**

---

Know the width of your equipment in order to maintain proper clearance when you operate the equipment near fences or near boundary obstacles.

Be aware of high voltage power lines and power cables that are buried. If the machine comes in contact with these hazards, serious injury or death may occur from electrocution.

---

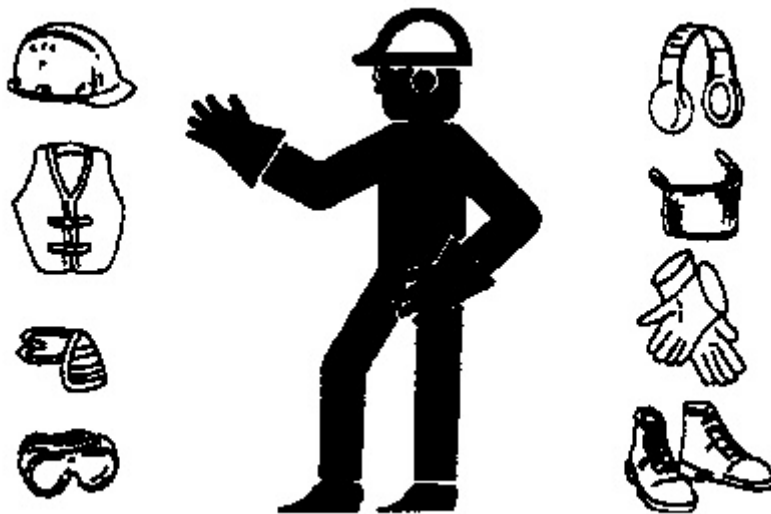

---

Illustration 2

g00702020

Wear a hard hat, protective glasses, and other protective equipment, as required.

Do not wear loose clothing or jewelry that can snag on controls or on other parts of the equipment.

Make sure that all protective guards and all covers are secured in place on the equipment.

Keep the equipment free from foreign material. Remove debris, oil, tools, and other items from the deck, from walkways, and from steps.

Secure all loose items such as lunch boxes, tools, and other items that are not a part of the equipment.

Know the appropriate work site hand signals and the personnel that are authorized to give the hand signals. Accept hand signals from one person only.

Do not smoke when you service an air conditioner. Also, do not smoke if refrigerant gas may be present. Inhaling the fumes that are released from a flame that contacts air conditioner refrigerant can cause bodily harm or death. Inhaling gas from air conditioner refrigerant through a lighted cigarette can cause bodily harm or death.

Never put maintenance fluids into glass containers. Drain all liquids into a suitable container.

**<https://www.ebooklibonline.com>**

Hello dear friend!

Thank you very much for reading.

Enter the link into your browser.

The full manual is available for immediate download.

**<https://www.ebooklibonline.com>**