

Product: EXCAVATOR

Model: 320C EXCAVATOR CLM

Configuration: 320C U 320C LU Excavators CLM00001-UP (MACHINE) POWERED BY 3066 Engine

## **Operation and Maintenance Manual 320C U Excavator**

Media Number -SEBU7503-06

Publication Date -01/12/2004

Date Updated -16/12/2004

s00037320

## **Foreword**

SMCS - 6001-011; 6001; 6101; 6102; 6523

## **Literature Information**

This manual should be stored in the operator's compartment in the literature holder or seat back literature storage area.

This manual contains safety information, operation instructions, transportation information, lubrication information and maintenance information.

Some photographs or illustrations in this publication show details or attachments that can be different from your machine. Guards and covers might have been removed for illustrative purposes.

Continuing improvement and advancement of product design might have caused changes to your machine which are not included in this publication. Read, study and keep this manual with the machine.

Whenever a question arises regarding your machine, or this publication, please consult your Cat dealer for the latest available information.

## **Safety**

The safety section lists basic safety precautions. In addition, this section identifies the text and locations of warning signs and labels used on the machine.

Read and understand the basic precautions listed in the safety section before operating or performing lubrication, maintenance and repair on this machine.

## **Operation**

The operation section is a reference for the new operator and a refresher for the experienced operator. This section includes a discussion of gauges, switches, machine controls, attachment controls, transportation and towing information.

Photographs and illustrations guide the operator through correct procedures of checking, starting, operating and stopping the machine.

Operating techniques outlined in this publication are basic. Skill and techniques develop as the operator gains knowledge of the machine and its capabilities.

## Maintenance

The maintenance section is a guide to equipment care. The Maintenance Interval Schedule (MIS) lists the items to be maintained at a specific service interval. Items without specific intervals are listed under the "When Required" service interval. The Maintenance Interval Schedule lists the page number for the step-by-step instructions required to accomplish the scheduled maintenance. Use the Maintenance Interval Schedule as an index or "one safe source" for all maintenance procedures.

### Maintenance Intervals

Use the service hour meter to determine servicing intervals. Calendar intervals shown (daily, weekly, monthly, etc.) can be used instead of service hour meter intervals if they provide more convenient servicing schedules and approximate the indicated service hour meter reading. Recommended service should always be performed at the interval that occurs first.

Under extremely severe, dusty or wet operating conditions, more frequent lubrication than is specified in the maintenance intervals chart might be necessary.

Perform service on items at multiples of the original requirement. For example, at every 500 service hours or 3 months, also service those items listed under every 250 service hours or monthly and every 10 service hours or daily.

## California Proposition 65 Warning

Diesel engine exhaust and some of its constituents are known to the State of California to cause cancer, birth defects, and other reproductive harm.

Battery posts, terminals and related accessories contain lead and lead compounds. **Wash hands after handling.**

## Certified Engine Maintenance

Proper maintenance and repair is essential to keep the engine and machine systems operating correctly. As the heavy duty off-road diesel engine owner, you are responsible for the performance of the required maintenance listed in the Owner Manual, Operation and Maintenance Manual, and Service Manual.

It is prohibited for any person engaged in the business of repairing, servicing, selling, leasing, or trading engines or machines to remove, alter, or render inoperative any emission related device or element of design installed on or in an engine or machine that is in compliance with the

regulations (40 CFR Part 89). Certain elements of the machine and engine such as the exhaust system, fuel system, electrical system, intake air system and cooling system may be emission related and should not be altered unless approved by Caterpillar.

## Machine Capacity

Additional attachments or modifications may exceed machine design capacity which can adversely affect performance characteristics. Included would be stability and system certifications such as brakes, steering, and rollover protective structures (ROPS). Contact your Cat dealer for further information.

## Cat Product Identification Number

Effective First Quarter 2001 the Cat Product Identification Number (PIN) has changed from 8 to 17 characters. In an effort to provide uniform equipment identification, Caterpillar and other construction equipment manufacturers are moving to comply with the latest version of the product identification numbering standard. Non-road machine PINs are defined by ISO 10261. The new PIN format will apply to all Cat machines and generator sets. The PIN plates and frame marking will display the 17 character PIN. The new format will look like the following:



---

Illustration 1

g00751314

Where:

1. Caterpillar's World Manufacturing Code (characters 1-3)
2. Machine Descriptor (characters 4-8)
3. Check Character (character 9)
4. Machine Indicator Section (MIS) or Product Sequence Number (characters 10-17). These were previously referred to as the Serial Number.

**<https://www.ebooklibonline.com>**

Hello dear friend!

Thank you very much for reading.

Enter the link into your browser.

The full manual is available for immediate download.

**<https://www.ebooklibonline.com>**

Machines and generator sets produced before First Quarter 2001 will maintain their 8 character PIN format.

Components such as engines, transmissions, axles, etc. and work tools will continue to use an 8 character Serial Number (S/N).

---



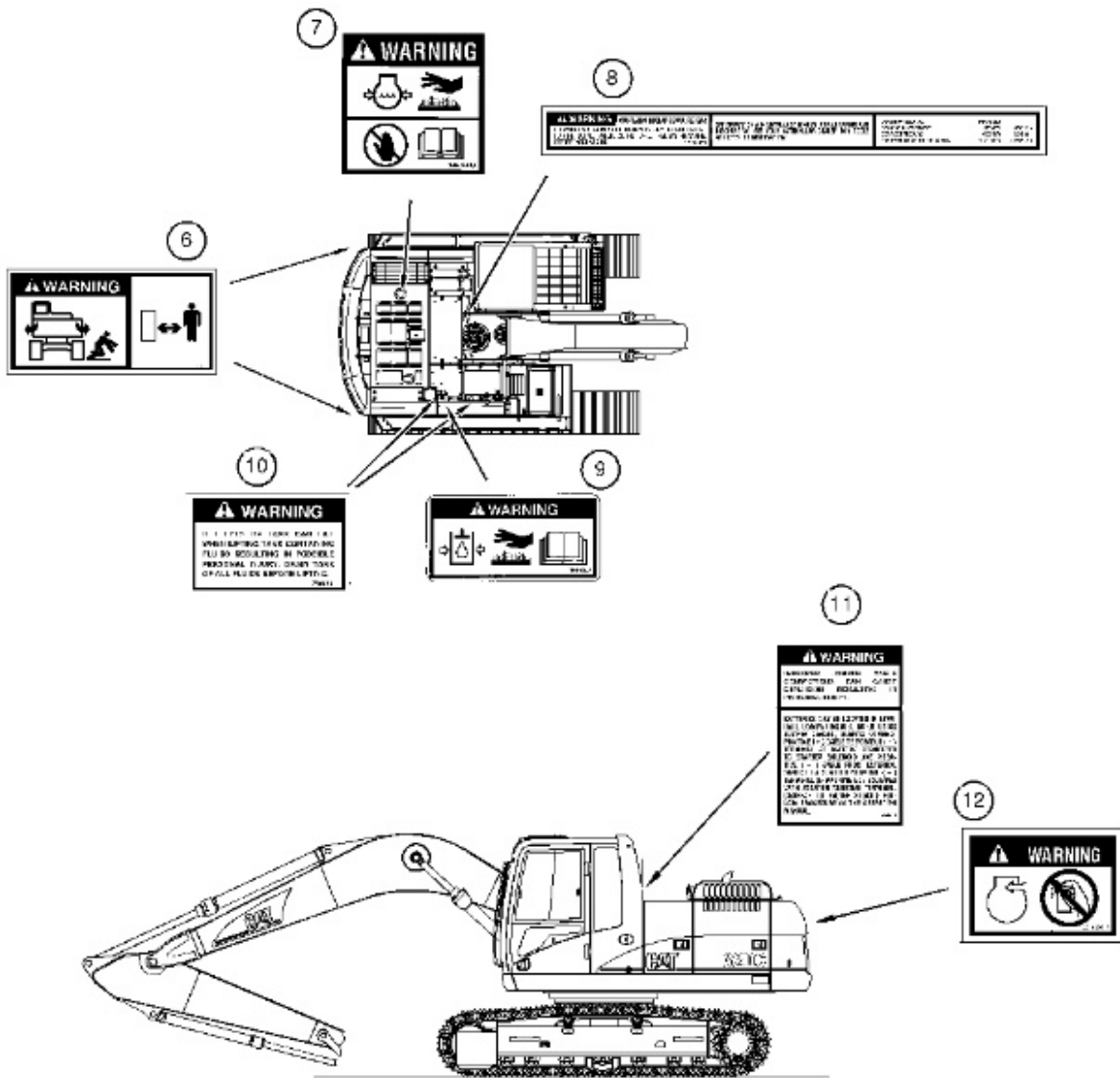

Illustration 3

g01015223

There are several specific safety messages on this machine. The exact location of the messages and the description of the messages are reviewed in this section. Please become familiarized with all safety messages.

Make sure that all of the safety messages are legible. Clean the safety messages or replace the safety messages if you cannot read the words. Replace the illustrations if the illustrations are not legible. When you clean the safety messages, use a cloth, water and soap. Do not use solvent, gasoline, or other harsh chemicals to clean the safety messages. Solvents, gasoline, or harsh chemicals could loosen the adhesive that secures the safety messages. Loose adhesive will allow the safety message to fall.

Replace any safety message that is damaged, or missing. If a safety message is attached to a part that is replaced, attach a safety message on the replacement part. Any Caterpillar dealer can provide new safety messages.

### (1) Do Not Operate

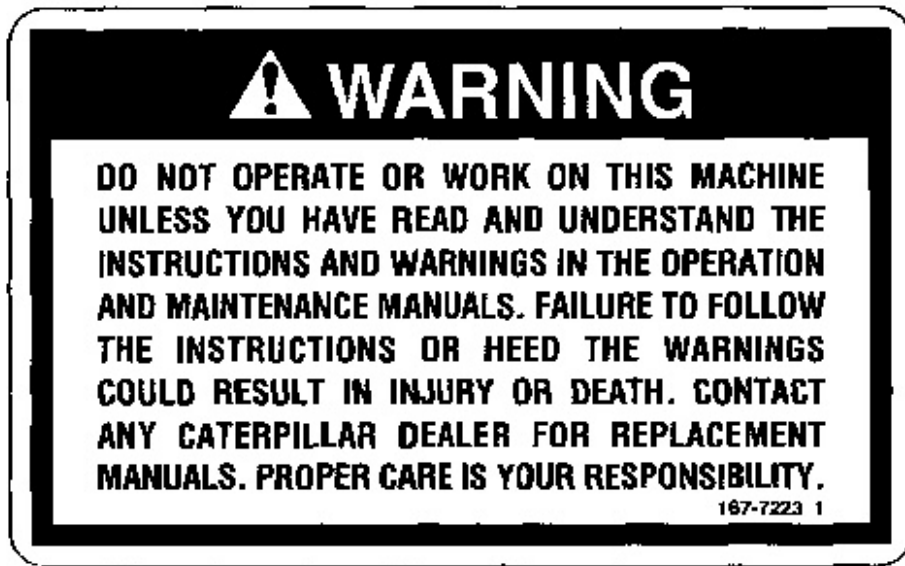

Illustration 4

g00684449

This safety message is located in the cab.



**Do not operate or work on this machine unless you have read and understand the instructions and warnings in the Operation and Maintenance Manuals. Failure to follow the instructions or heed the warnings could result in injury or death. Contact your Caterpillar dealer for replacement manuals. Proper care is your responsibility.**

---

**(2) Crushing Hazard**



Illustration 5

g00684465

This safety message is located in the cab.



Personal injury can result if the window is not latched in the overhead position; ensure the auto lock is engaged.

### (3) Travel Speed Control Switch

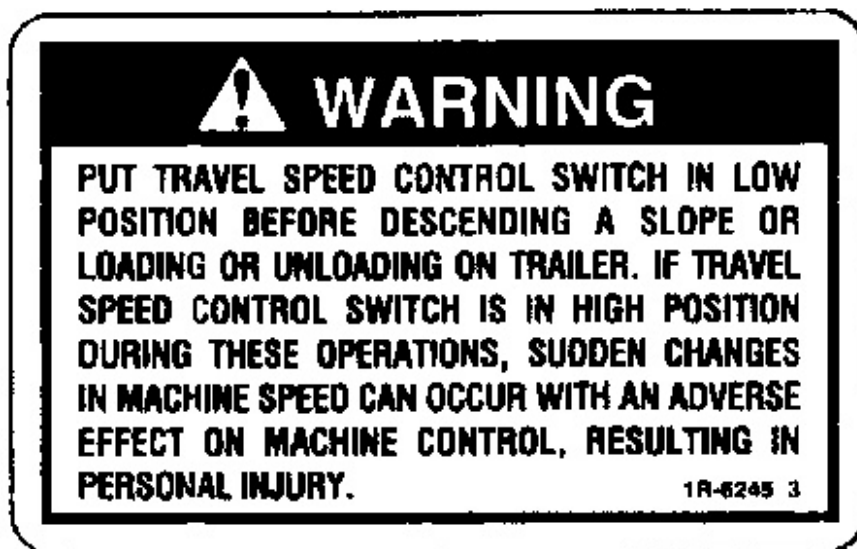

Illustration 6

g00577852

This safety message is located in the cab.

 **WARNING**

Put travel speed control switch in **LOW** position before descending a slope or loading or unloading on trailer. If travel speed control switch is in **HIGH** position during these operations, sudden changes in machine speed can occur with an adverse effect on machine control, resulting in personal injury.

**(4) Automatic Engine Speed Control (AEC)**

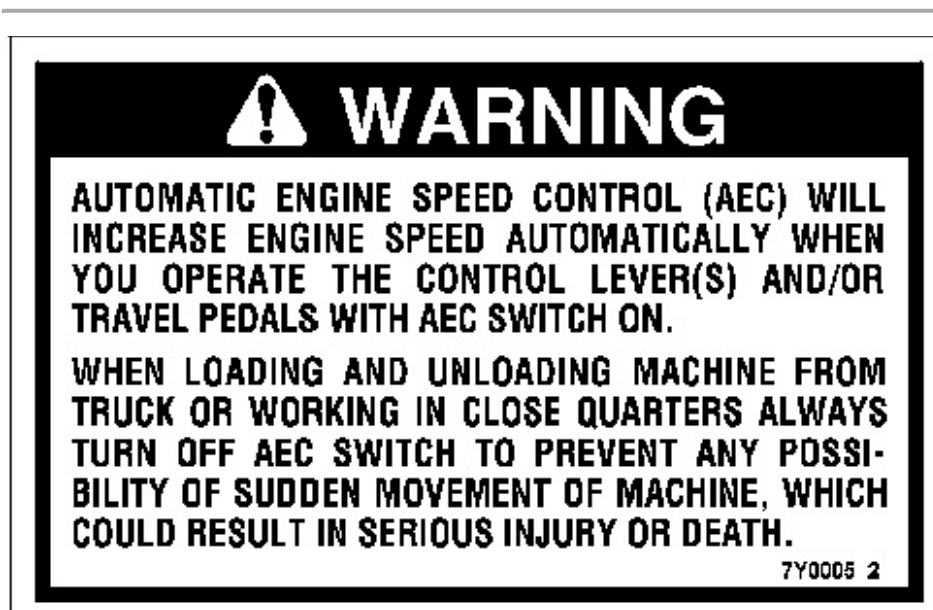

Illustration 7

g00100749

This safety message is located in the cab.

 **WARNING**

Automatic Engine Speed Control (AEC) will increase engine speed automatically when you operate the control lever(s) and/or travel pedals when in position **TWO**.

When loading and unloading machine from truck or working in close quarters, always have AEC switch in position **ONE** to prevent any possibility of sudden movement of machine, which could result in serious injury or death.

(5) Electrical Power Lines

---



Illustration 8

g00100702

This safety message is located in the cab.

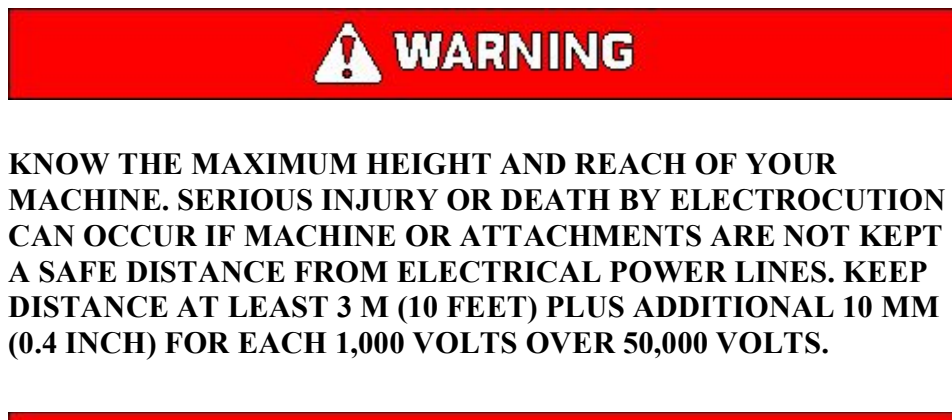

(6) Machine Swing

---

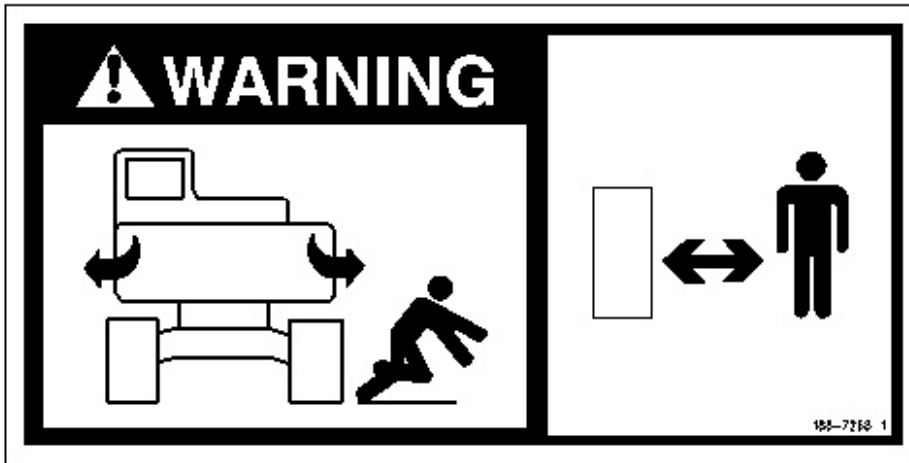

---

Illustration 9

g00750340

This safety message is located on the two outside rear corners of the machine.



**Machine swings. Stay back. Crushing hazard could cause serious injury or death.**

---

**(7) Pressurized System**



Illustration 10

g00768931

This safety message is located inside the engine compartment next to the cooling system filler cap.



**Pressurized system: Hot coolant can cause serious burn. To open cap, stop engine, wait until radiator is cool. Then loosen cap slowly to relieve the pressure.**

### (8) High Pressure Gas



This safety message is located on the hydraulic accumulator.



**This system contains high pressure gas. Failure to follow the instructions and warnings could cause an explosion, resulting in possible injury or death.**

**Do not expose to fire. Do not weld. Do not drill. Relieve pressure before discharging.**

**See Operation and Maintenance Manual for charging and discharging. See your Caterpillar Dealer for tools and detailed information.**

---

**(9) Relieve Hydraulic Tank Pressure**



This safety message is located on top of the hydraulic tank.



**HYDRAULIC TANK**

**RELIEVE TANK PRESSURE WITH ENGINE OFF BY REMOVING CAP SLOWLY TO PREVENT BURNS FROM HOT OIL.**

---

## (10) Lift Eyes Can Fail

---

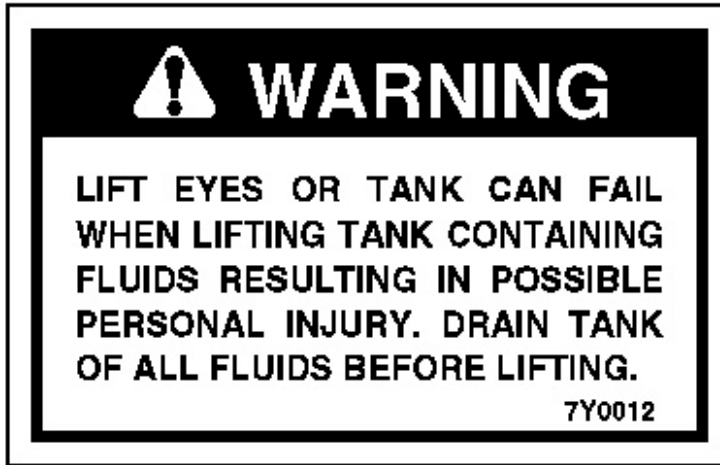

---

Illustration 13

g00100728

This safety message is located on the top of the hydraulic tank and on top of the fuel tank.



**LIFT EYES OR TANK CAN FAIL WHEN LIFTING TANK CONTAINING FLUIDS RESULTING IN POSSIBLE PERSONAL INJURY. DRAIN TANK OF ALL FLUIDS BEFORE LIFTING.**

---

## (11) Jump Start Cables

---



---

Illustration 14

g00913047

This safety message is located on the right side of the circuit breaker panel.



**IMPROPER JUMPER CABLE CONNECTIONS CAN CAUSE EXPLOSION RESULTING IN PERSONAL INJURY.**

**BATTERIES MAY BE LOCATED IN SEPARATE COMPARTMENTS. WHEN USING JUMPER CABLES, ALWAYS CONNECT POSITIVE (+) CABLE TO POSITIVE (+) TERMINAL OF BATTERY CONNECTED TO STARTER SOLENOID AND NEGATIVE (-) CABLE FROM EXTERNAL SOURCE TO STARTER NEGATIVE (-) TERMINAL (IF MACHINE NOT EQUIPPED WITH STARTER NEGATIVE TERMINAL, CONNECT TO ENGINE BLOCK.) FOLLOW PROCEDURE IN THE OPERATION MANUAL.**

---

(12) Aerosol Starting Aid

---



Illustration 15

g00912750

This safety message is located on the cover of the intake duct of the air cleaner.



**Since this machine is equipped with an air inlet heater, ether should not be used for starting. Using ether can create explosions or fires that can cause personal injury or death. Follow the starting procedure in the Operation and Maintenance Manual.**

### Product Link



This safety message is located in the cab.



**This machine is equipped with a Caterpillar Product Link radio communication device which must be deactivated within 6.0 m (20 ft) of a blast zone. Failure to do so could result in serious injury or death.**

---

Product: EXCAVATOR

Model: 320C EXCAVATOR CLM

Configuration: 320C U 320C LU Excavators CLM00001-UP (MACHINE) POWERED BY 3066 Engine

## Operation and Maintenance Manual 320C U Excavator

Media Number -SEBU7503-06

Publication Date -01/12/2004

Date Updated -16/12/2004

i01948255

### Additional Messages

SMCS - 7000; 7405

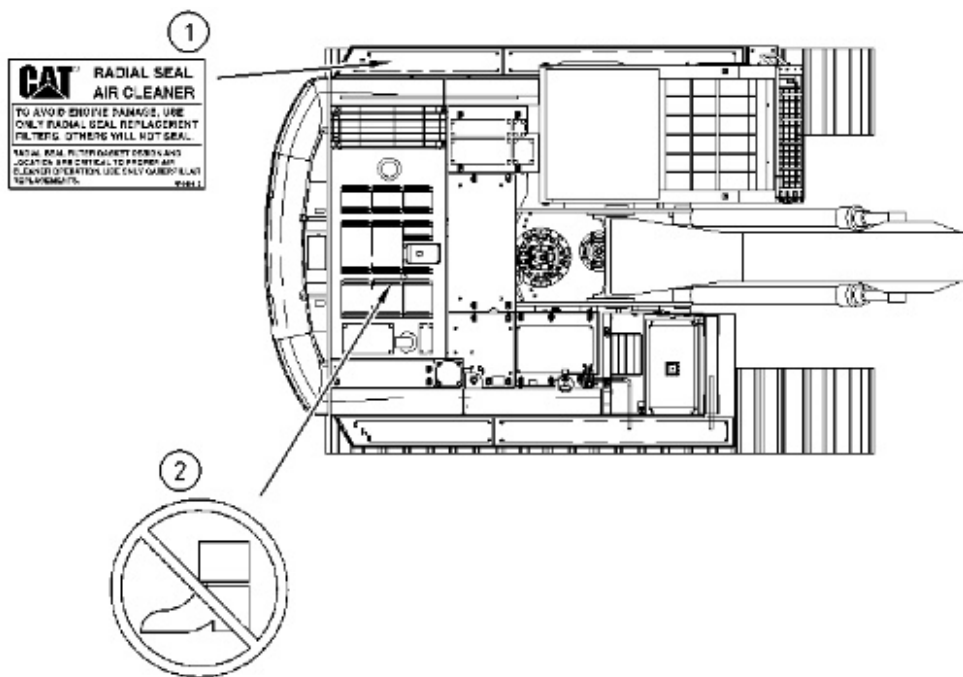

Illustration 1

g00937179

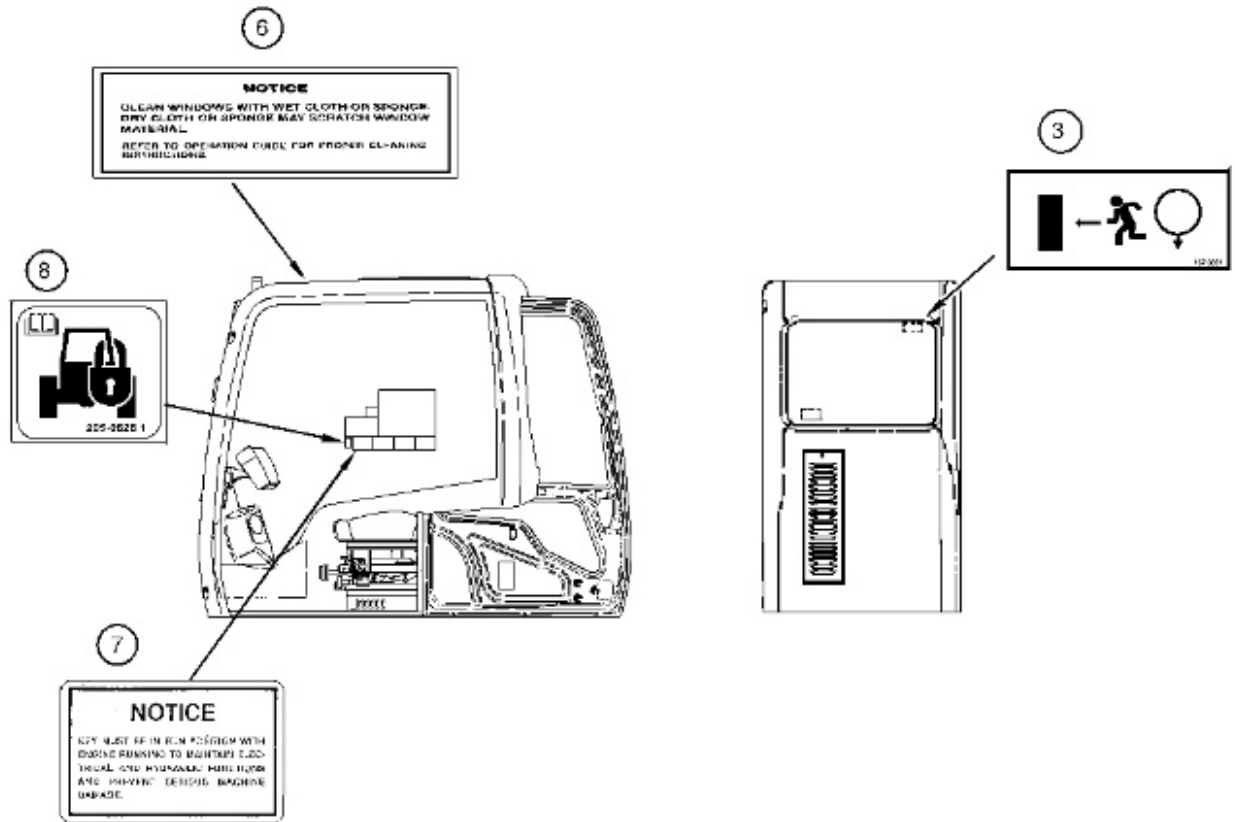

Illustration 2

g01014168

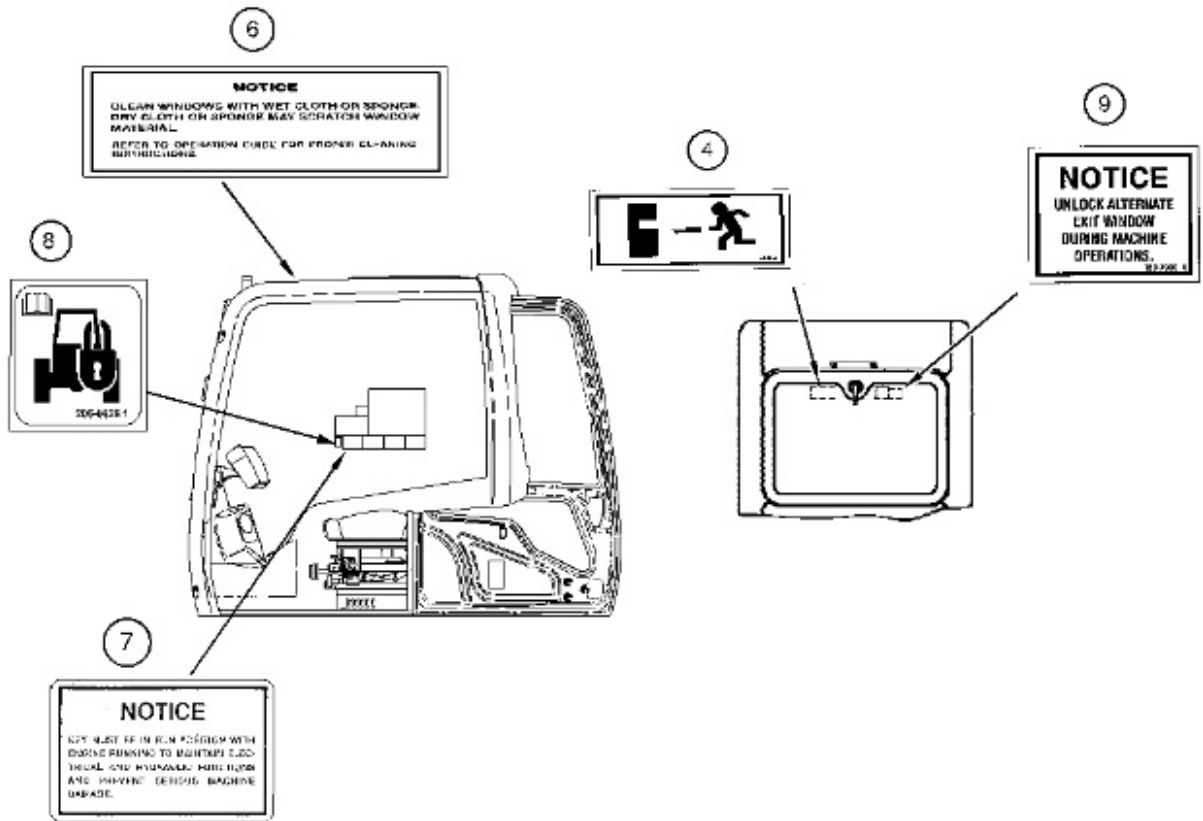

Illustration 3

g01014172

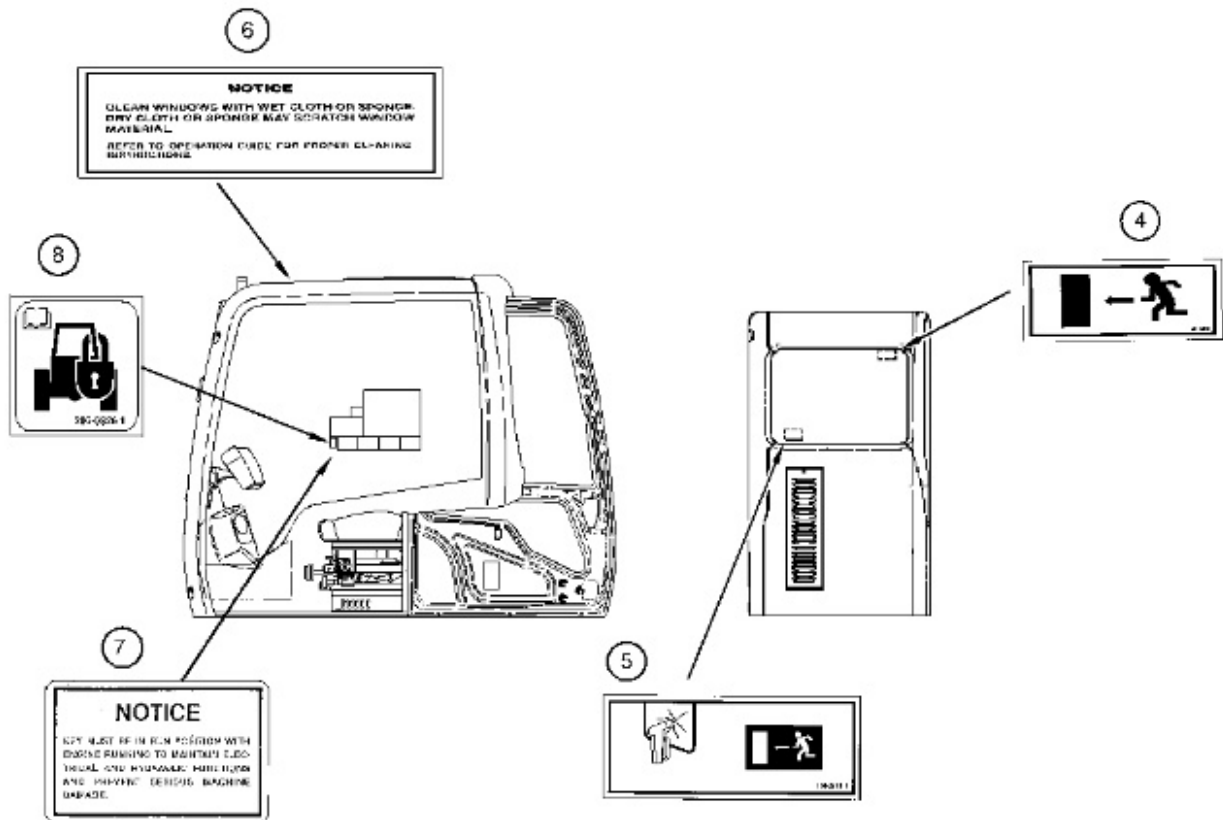

Illustration 4

g01014173

### Radial Air Cleaner (1)

This message is located on the cover of the air cleaner.



---

Illustration 5

g00911166

In order to avoid engine damage, replace old filters with radial seal air filters. Other replacement filters will not seal.

The location and design of the gasket for the radial seal air filter is critical to the proper operation of the air cleaner element. Use only Caterpillar replacements.

**No Step (2)**

This message is located on the engine cover on the top of the machine.

---

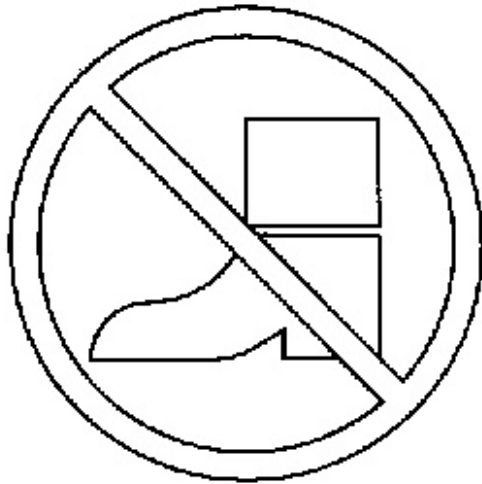

---

Illustration 6

g00911158

Do not step in this area.

**Alternate Exit (3)**

This message is located in the upper right corner of the rear window.

---

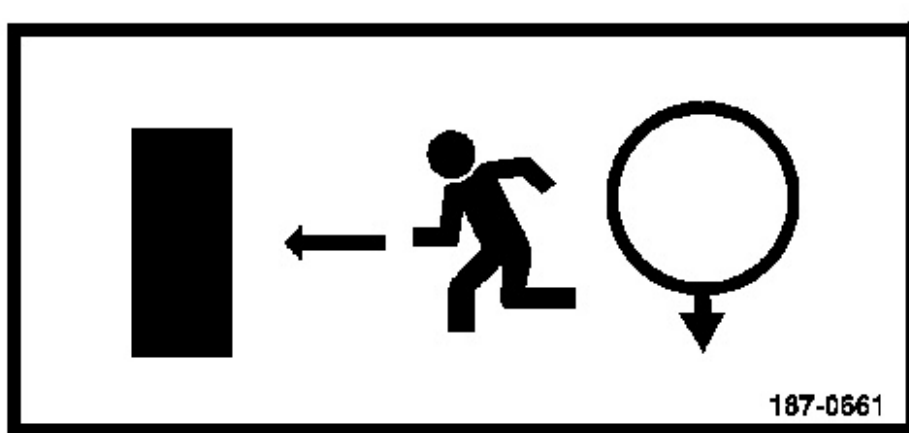

---

Illustration 7

g00939891

If the Primary exits are blocked, pull the ring in order to open the rear window. Exit the machine through the window.

**Alternate Exit (If Equipped) (4)**

This message is located on the rear window of the cab.



**Suggest:**

**For more complete manuals. Please go to the home page.**

**<https://www.ebooklibonline.com>**

**If the above button click is invalid. Please download this document first, and then click the above link to download the complete manual.**

**Thank you so much for reading**

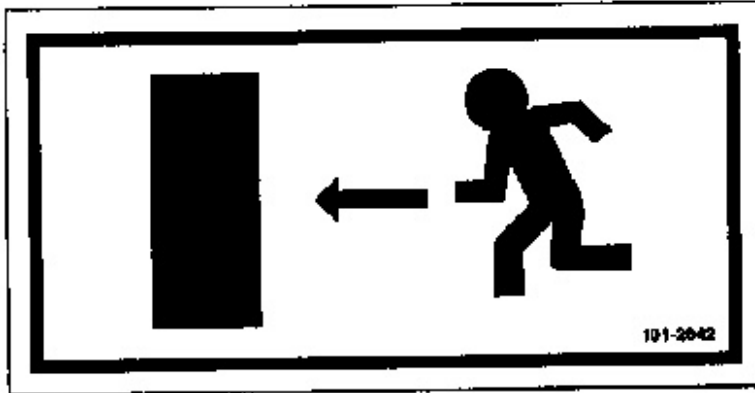

Illustration 8

g00911516

Exit through rear window.

**Alternate Exit (If Equipped) (5)**

This message is located on the back window of the cab in the lower left hand corner.

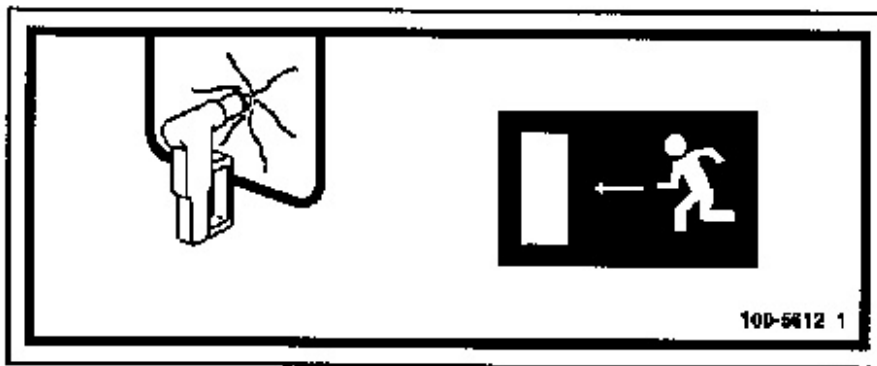

Illustration 9

g00911175

Break glass in order to exit.

**Clean Glass (6)**

Notice (6) is located on the upper window in the cab.

---

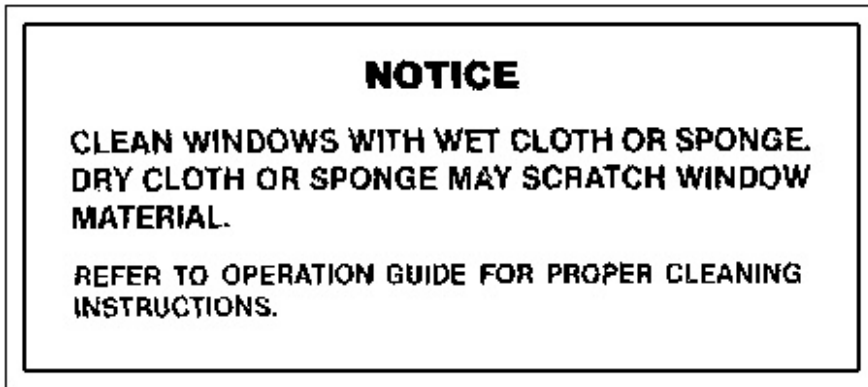

---

Illustration 10

g00911414

---

**NOTICE**

**Clean windows with a wet cloth or sponge. Dry cloth or sponge may  
scratch window material.**

---

**Key in Run Position (7)**

Notice (7) is located on the window on the right side of the cab.

---

**<https://www.ebooklibonline.com>**

Hello dear friend!

Thank you very much for reading.

Enter the link into your browser.

The full manual is available for immediate download.

**<https://www.ebooklibonline.com>**