

Product: SKID STEER LOADER

Model: 242B SKID STEER LOADER BXM

Configuration: 242B2 Skid Steer Loader BXM04225-UP (MACHINE) POWERED BY 3024C Engine

Operation and Maintenance Manual 216B2, 226B2, 232B2, 236B2, 242B2 and 252B2 Skid Steer Loaders

Media Number -SEBU8385-04

Publication Date -01/01/2011

Date Updated -13/03/2017

i02857061

Safety Messages

SMCS - 7000; 7405

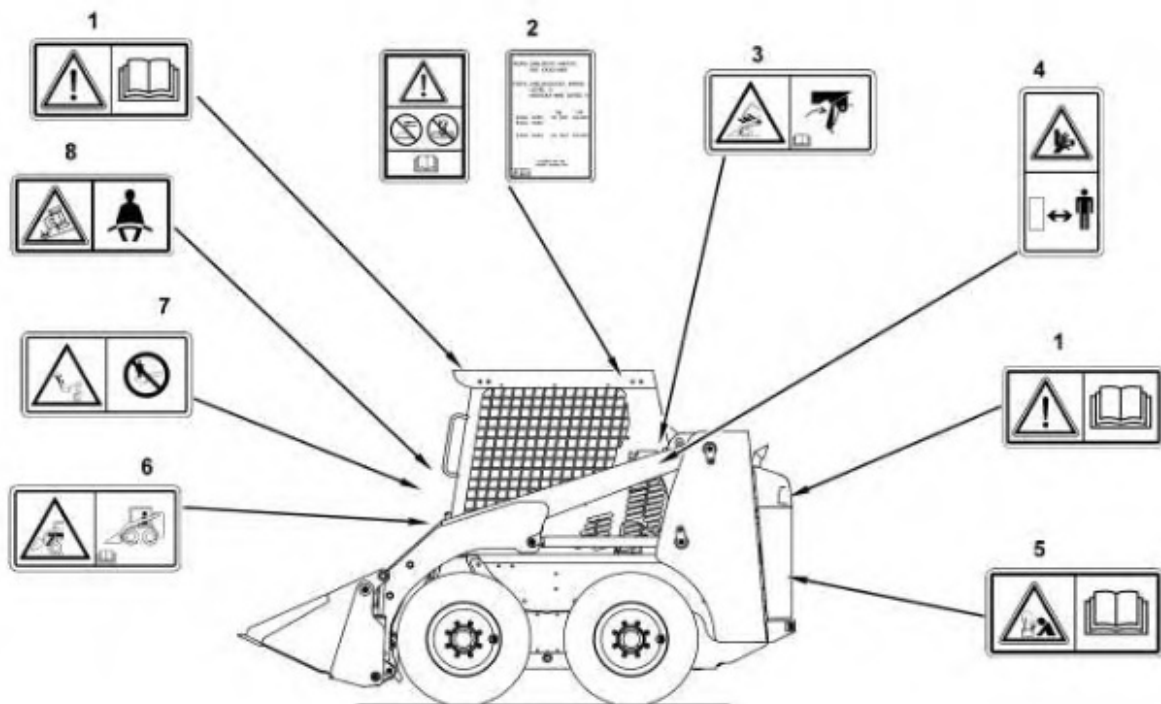

Illustration 1

g01428625

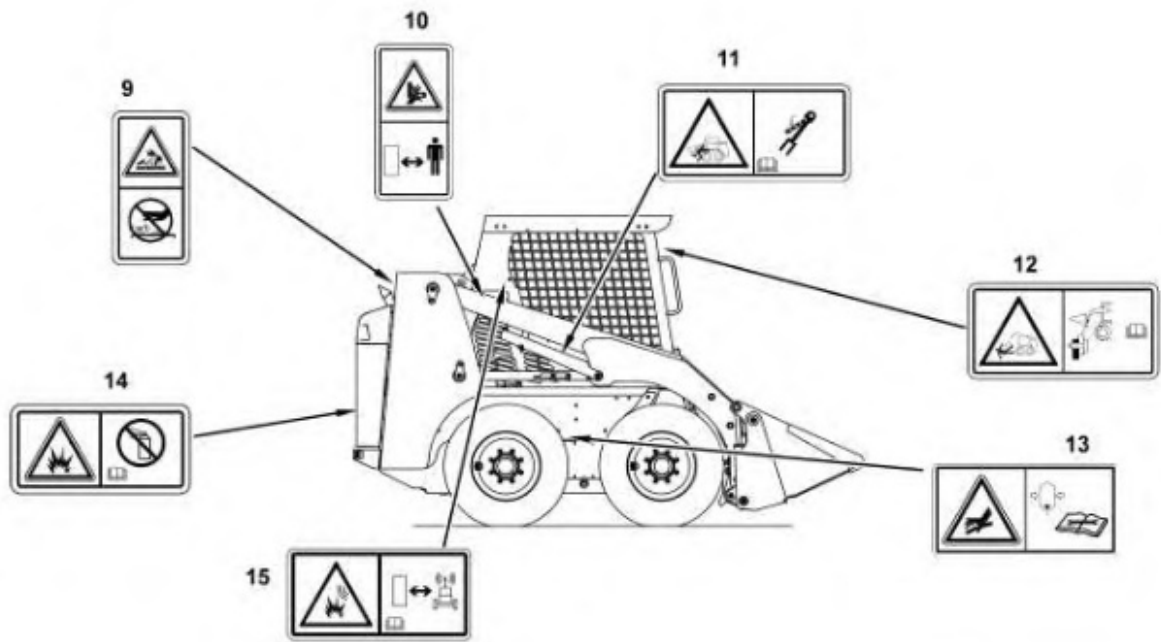

Illustration 2

g01423202

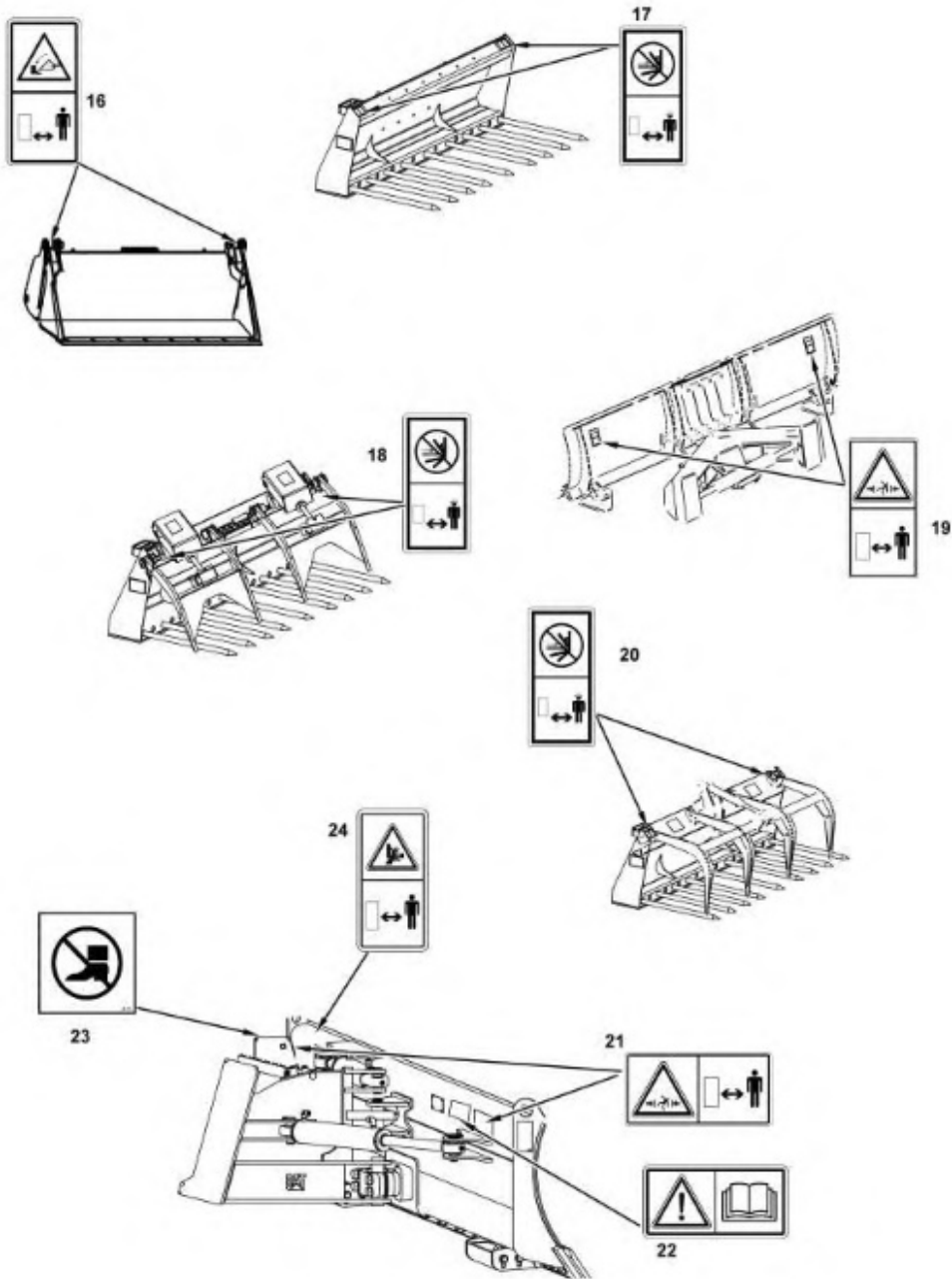

Illustration 3

g01433202

There are several specific safety messages on this machine. The exact location of the hazards and the description of the hazards are reviewed in this section. Please become familiarized with all safety messages.

Make sure that all of the safety messages are legible. Clean the safety messages or replace the safety messages if you cannot read the words. Replace the illustrations if the illustrations are not legible. When you clean the safety messages, use a cloth, water and soap. Do not use solvent, gasoline, or other harsh chemicals to clean the safety messages. Solvents, gasoline, or harsh chemicals could loosen the adhesive that secures the safety message. Loose adhesive will allow the safety message to fall.

Replace any safety message that is damaged, or missing. If a safety message is attached to a part that is replaced, install a safety message on the replacement part. Any Caterpillar dealer can provide new safety messages.

<https://www.ebooklibonline.com>

Hello dear friend!

Thank you very much for reading.

Enter the link into your browser.

The full manual is available for immediate download.

<https://www.ebooklibonline.com>

Do Not Operate (1)

This warning message is located inside the cab on the upper left side. This warning message is located also on the engine.

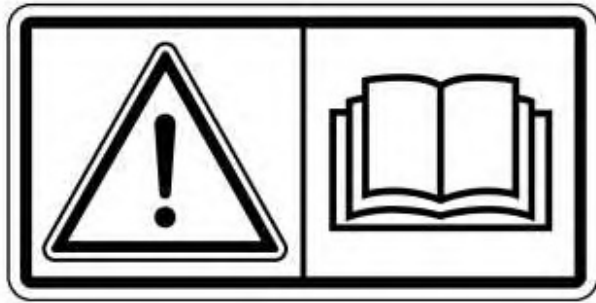

Illustration 4

g01370904



Read and understand the instructions and warnings in the operation and maintenance manuals. Contact any Caterpillar dealer for replacement manuals. Proper care is your responsibility.

Be alert! Know work conditions. Note and avoid all hazards and obstructions. Keep by-standers away when operating.

Fasten seat belt and lower armrest.

Make certain all controls are in neutral position and start engine.

Disengage parking brake.

Machine controls are active.

Failure to follow the instructions or heed the warnings could result injury or death.

Rollover Protective Structure/Falling Object Protective Structure (2)

This warning film and the certification film are located inside the cab on the upper left side.



Illustration 5

g01211895



Structural damage, an overturn, modification, alteration, or improper repair can impair this structure's protection capability thereby voiding this certification. Do not weld on or drill holes in the structure. Consult a Caterpillar dealer to determine this structure's limitations without voiding its certification.

This machine has been certified to the standards that are listed on the certification plate. The maximum mass of the machine, which includes the operator and the attachments without a payload, should not exceed the mass on the certification film.

Cab Support (3)

This warning message is located on the left side of the machine near the cab support lever. This warning message is also located inside the cab on the lower left side.

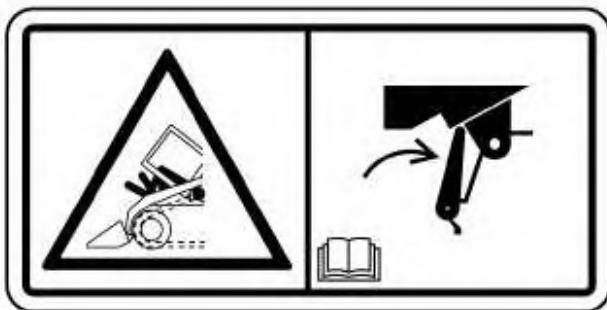

Illustration 6

g01427440



Do not go beneath cab unless cab is empty and support lever is engaged.

Failure to follow the instructions or heed the warnings could result in injury or death.

Crush Hazard (4)

This warning is located on the loader arms of the machines that are equipped with extended reach.



Illustration 7

g01378775



No clearance for person in this area during operation. Severe injury or death from crushing could occur. Stay away from the work tool while it is in operation.

Batteries (5)

This warning message is located on the inside of the engine access door.

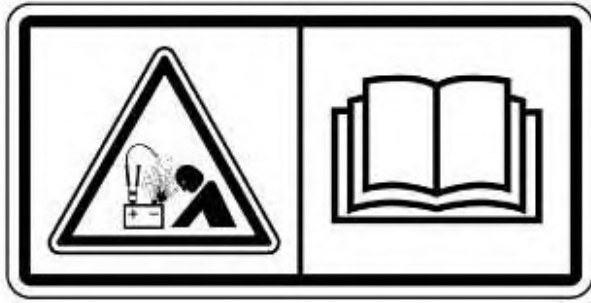

Illustration 8

g01370909

! WARNING

Improper jumper cable connections can cause explosion resulting in personal injury. Batteries may be located in separate compartments, always connect positive (+) cable to positive (+) terminal of battery connected to starter solenoid and negative (-) cable from external source to engine block or frame.

Stay Inside Operator Station (6)

This warning message is located below the operator seat.

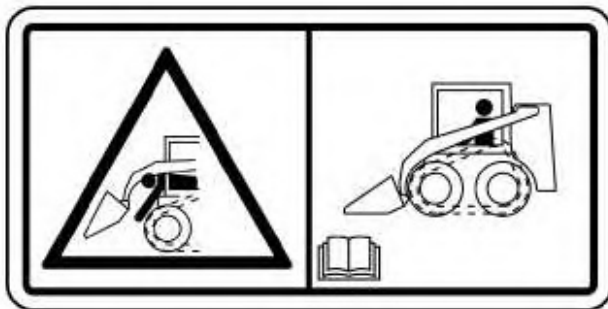

Illustration 9

g01427449

! WARNING

**Keep your body inside the operator station while operating the loader.
Never work with your arms, feet or legs beyond the operator station.**

Failure to follow the instructions or heed the warnings will result in injury or death.

Never Permit Riders (7)

This warning message is located below the operator seat.

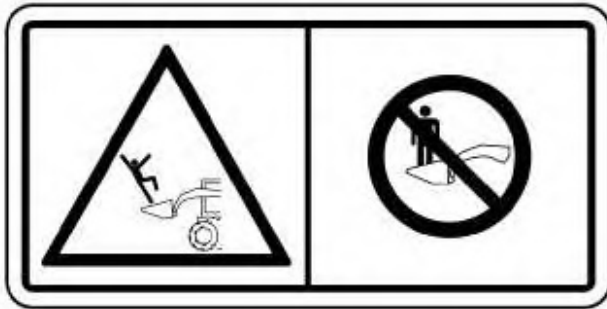

Illustration 10

g01427444



Never permit riders.

Never use work tool for a work platform.

Failure to follow the instructions or heed the warnings could result in injury or death.

Seat Belt (8)

This warning message is located below the operator seat.





A seat belt should be worn at all times during machine operation to prevent serious injury or death in the event of an accident or machine overturn. Failure to wear a seat belt during machine operation may result in serious injury or death.

Refer to Operation and Maintenance Manual, "Seat Belt" for more information.

Pressurized System (9)

This warning message is located below the radiator cap.



Pressurized system: Hot coolant can cause serious burn. To open cap, stop engine, wait until radiator is cool. Then loosen cap slowly to relieve the pressure.

Crush Hazard (10)

This warning is located on the loader arms.



Illustration 13

g01378775

 **WARNING**

No clearance for person in this area during operation. Severe injury or death from crushing could occur. Stay away from the work tool while it is in operation.

Brace for the Loader Lift Arms (11)

This warning message is located on the brace for the loader lift arms.

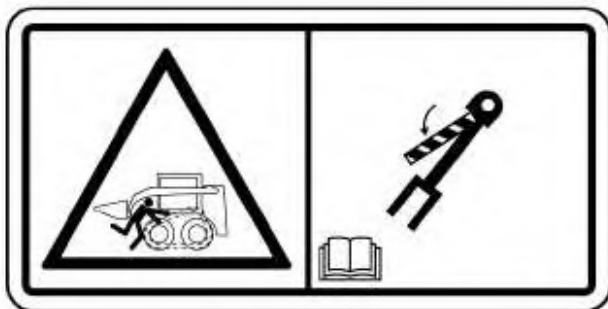

Illustration 14

g01427443

 **WARNING**

Loader lift arm brace must be in place when working under raised lift arms.

Failure to follow the instructions or heed the warnings could result in injury or death.

Refer to Operation and Maintenance Manual, "Loader Lift Arm Brace Operation" for operating information.

Work Tool Coupler (12)

This warning message is located inside the cab on the upper left side.

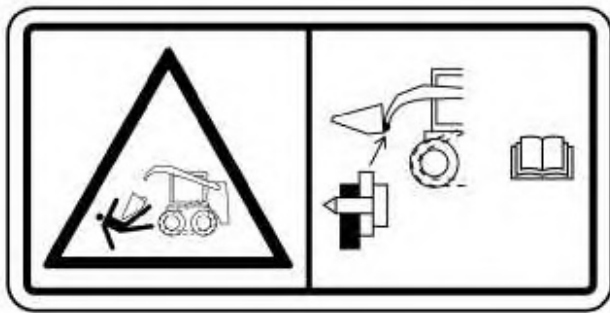

Illustration 15

g01427447

! WARNING

Improper Attachment of the Work Tool could result in injury or death.

Do not operate the machine without confirmation that the coupler pins are fully engaged. Follow the operating procedures in the Operation and Maintenance Manual.

Tilt the work tool downward.

Put down pressure on the work tool.

Move the machine backward. Ensure that the work tool has not separated from the coupler assembly.

Accumulator (13)

This warning message is located near the accumulator underneath the cab.

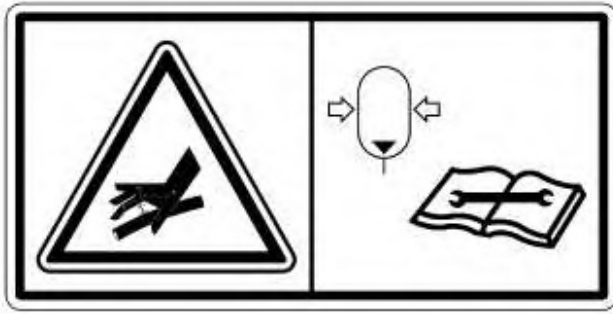

Illustration 16

g01370912

! WARNING

Accumulator may contain high pressure oil. Do not service the accumulator or any hydraulic lines until all of the pressure has been relieved. See the Service Manual for proper procedures. Failure to heed this warning could result in injury or death.

Aerosol Starting Aid (14)

This warning message is located on top of the fuel pump housing.



Illustration 17

g01372254

! WARNING

Do not use aerosol types of starting aids such as ether. Such use could result in an explosion and personal injury.

Product Link (15)

This safety message is located inside the cab on the right hand window.

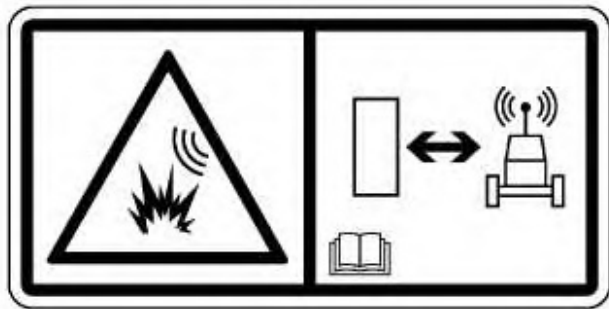

Illustration 18

g01370917

 **WARNING**

This machine is equipped with a Caterpillar Product Link communication device which must be deactivated within 12 m (40 ft) of a blast zone. Failure to do so could result in serious injury or death.

Multipurpose Bucket (16)

These warning messages are located on the front of the multipurpose bucket.



Illustration 19

g01389199

! WARNING

No clearance for person in this area during operation. Severe injury or death from crushing could occur. Stay away from the work tool while it is in operation.

Utility Fork (17)

These warning messages are located on top of the fork carriage.



Illustration 20

g01381064

! WARNING

No clearance for person in this area during operation. Severe injury or death from impalement could occur. Stay away from the work tool while it is in operation.

Industrial Grapple Fork (18)

These warning messages are located on top of the fork carriage.



Illustration 21

g01381064



No clearance for person in this area during operation. Severe injury or death from impalement could occur. Stay away from the work tool while it is in operation.

Angle Blade (19)

These warning messages are located on the back side of the blade.



Illustration 22

g01377717

! WARNING

No clearance for person in this area during operation. Severe injury or death from crushing could occur. Stay away from the work tool while it is in operation.

Utility Grapple Fork (20)

These warning messages are located on top of the fork carriage.



Illustration 23

g01381064

! WARNING

No clearance for person in this area during operation. Severe injury or death from impalement could occur. Stay away from the work tool while it is in operation.

Dozer Blade (21)

These warning messages are located on the back side of the blade.

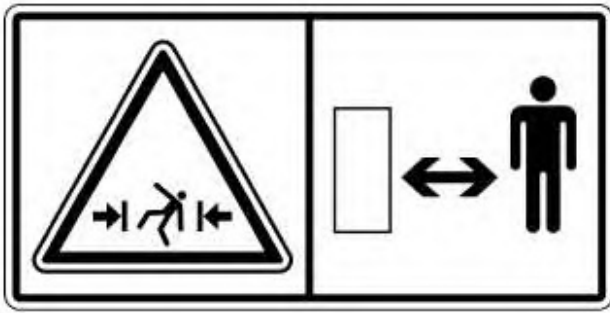

Illustration 24

g01371644

 **WARNING**

No clearance for person in this area during operation. Severe injury or death from crushing could occur. Stay away from the work tool while it is in operation.

Dozer Blade (22)

This warning is located on right hand side on the back of the blade.



Illustration 25

g01370904

 **WARNING**

DO NOT OPERATE OR WORK ON THIS MACHINE UNLESS YOU HAVE READ AND UNDERSTAND THE INSTRUCTIONS AND WARNINGS IN THE OPERATION AND MAINTENANCE MANUALS. FAILURE TO FOLLOW THE INSTRUCTIONS OR HEED THE WARNINGS COULD RESULT IN INJURY OR DEATH.

**CONTACT ANY CATERPILLAR DEALER FOR REPLACEMENT
MANUALS. PROPER CARE IS YOUR RESPONSIBILITY.**

Dozer Blade (23)

This warning message is located on top of the dozer blade.

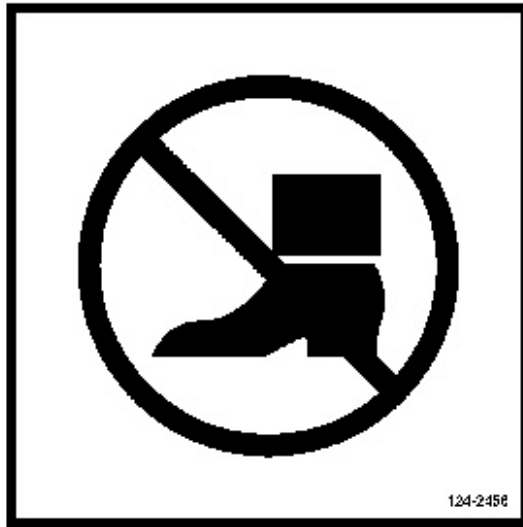

Illustration 26

g00946617



**Falling Hazard - Area may be oily and slippery. Do not step on
cylinders. Serious injury or death could occur from a fall.**

Dozer Blade (24)

This warning message is located on top of the dozer blade.



Illustration 27

g01378775

 **WARNING**

No clearance for person in this area during operation. Severe injury or death from crushing could occur. Stay away from the work tool while it is in operation.

Product: SKID STEER LOADER

Model: 242B SKID STEER LOADER BXM

Configuration: 242B2 Skid Steer Loader BXM04225-UP (MACHINE) POWERED BY 3024C Engine

Operation and Maintenance Manual 216B2, 226B2, 232B2, 236B2, 242B2 and 252B2 Skid Steer Loaders

Media Number -SEBU8385-04

Publication Date -01/01/2011

Date Updated -13/03/2017

i02879615

Additional Messages

SMCS - 7000; 7405

Product Link



Illustration 1

g01418953

The Product Link System is a satellite communication device that transmits information regarding the machine back to Caterpillar and Caterpillar dealers and customers. All logged events and diagnostic codes that are available to the Caterpillar Electronic Technician (ET) on the CAT data link can be sent to the satellite. Information can also be sent to the Product Link System. The information is used to improve Caterpillar products and Caterpillar services.

Refer to Operation and Maintenance Manual, "Product Link" for more information.



Suggest:

For more complete manuals. Please go to the home page.

<https://www.ebooklibonline.com>

If the above button click is invalid. Please download this document first, and then click the above link to download the complete manual.

Thank you so much for reading

Product: SKID STEER LOADER

Model: 242B SKID STEER LOADER BXM

Configuration: 242B2 Skid Steer Loader BXM04225-UP (MACHINE) POWERED BY 3024C Engine

Operation and Maintenance Manual 216B2, 226B2, 232B2, 236B2, 242B2 and 252B2 Skid Steer Loaders

Media Number -SEBU8385-04

Publication Date -01/01/2011

Date Updated -13/03/2017

i07500894

General Hazard Information

SMCS - 7000

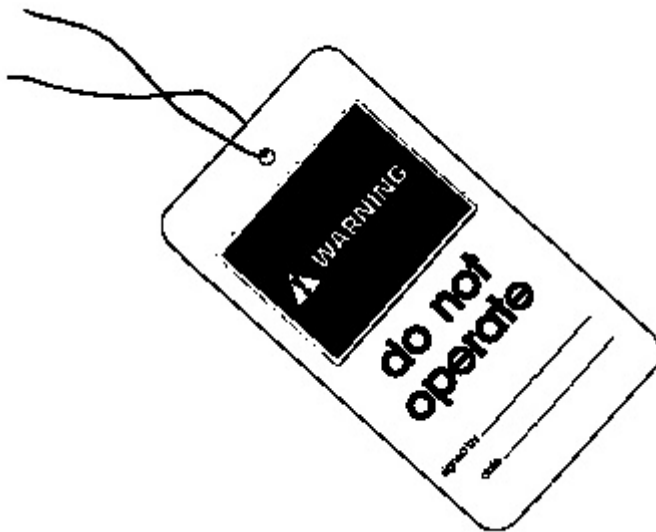

Illustration 1

g00104545

Typical example

Attach a "Do Not Operate" warning tag or a similar warning tag to the start switch or to the controls. Attach the warning tag before you service the equipment or before you repair the equipment. Warning tag SEHS7332 is available from your Cat dealer.



Operating the machine while distracted can result in the loss of machine control. Use extreme caution when using any device while operating the

machine. Operating the machine while distracted can result in personal injury or death.

Know the width of your equipment in order to maintain proper clearance when you operate the equipment near fences or near boundary obstacles.

Be aware of high voltage power lines and power cables that are buried. If the machine comes in contact with these hazards, serious injury or death may occur from electrocution.

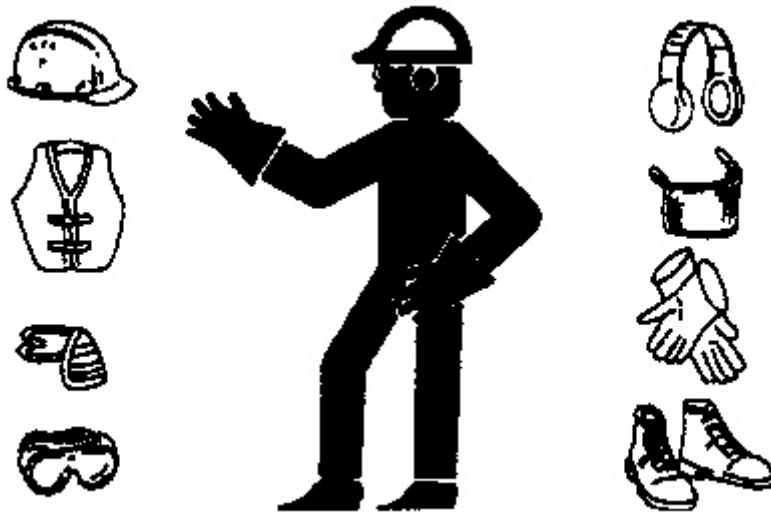

Illustration 2

g00702020

Wear a hard hat, protective glasses, and other protective equipment, as required.

Do not wear loose clothing or jewelry that can snag on controls or on other parts of the equipment.

Make sure that all protective guards and all covers are secured in place on the equipment.

Keep the equipment free from foreign material. Remove debris, oil, tools, and other items from the deck, from walkways, and from steps.

Secure all loose items such as lunch boxes, tools, and other items that are not a part of the equipment.

Know the appropriate work site hand signals and the personnel that are authorized to give the hand signals. Accept hand signals from one person only.

Do not smoke when you service an air conditioner. Also, do not smoke if refrigerant gas may be present. Inhaling the fumes that are released from a flame that contacts air conditioner refrigerant can cause bodily harm or death. Inhaling gas from air conditioner refrigerant through a lighted cigarette can cause bodily harm or death.

Never put maintenance fluids into glass containers. Drain all liquids into a suitable container.

<https://www.ebooklibonline.com>

Hello dear friend!

Thank you very much for reading.

Enter the link into your browser.

The full manual is available for immediate download.

<https://www.ebooklibonline.com>