

Product: BACKHOE LOADER

Model: 416D BACKHOE LOADER BFP

Configuration: 416D Backhoe Loader BFP00001-17198 (MACHINE) POWERED BY 3054 Engine

Operation and Maintenance Manual

416D Backhoe Loader

Media Number -SEBU7398-08

Publication Date -01/03/2015

Date Updated -03/03/2015

s00037320

Foreword

Literature Information

This manual should be stored in the operator's compartment in the literature holder or seat back literature storage area.

This manual contains safety information, operation instructions, transportation information, lubrication information and maintenance information.

Some photographs or illustrations in this publication show details or attachments that can be different from your machine. Guards and covers might have been removed for illustrative purposes.

Continuing improvement and advancement of product design might have caused changes to your machine which are not included in this publication. Read, study and keep this manual with the machine.

Whenever a question arises regarding your machine, or this publication, please consult your Cat dealer for the latest available information.

Safety

The safety section lists basic safety precautions. In addition, this section identifies the text and locations of warning signs and labels used on the machine.

Read and understand the basic precautions listed in the safety section before operating or performing lubrication, maintenance and repair on this machine.

Operation

The operation section is a reference for the new operator and a refresher for the experienced operator. This section includes a discussion of gauges, switches, machine controls, attachment controls, transportation and towing information.

Photographs and illustrations guide the operator through correct procedures of checking, starting, operating and stopping the machine.

Operating techniques outlined in this publication are basic. Skill and techniques develop as the operator gains knowledge of the machine and its capabilities.

Maintenance

The maintenance section is a guide to equipment care. The Maintenance Interval Schedule (MIS) lists the items to be maintained at a specific service interval. Items without specific intervals are listed under the "When Required" service interval. The Maintenance Interval Schedule lists the page number for the step-by-step instructions required to accomplish the scheduled maintenance. Use the Maintenance Interval Schedule as an index or "one safe source" for all maintenance procedures.

Maintenance Intervals

Use the service hour meter to determine servicing intervals. Calendar intervals shown (daily, weekly, monthly, etc.) can be used instead of service hour meter intervals if they provide more convenient servicing schedules and approximate the indicated service hour meter reading. Recommended service should always be performed at the interval that occurs first.

Under extremely severe, dusty or wet operating conditions, more frequent lubrication than is specified in the maintenance intervals chart might be necessary.

Perform service on items at multiples of the original requirement. For example, at every 500 service hours or 3 months, also service those items listed under every 250 service hours or monthly and every 10 service hours or daily.

California Proposition 65 Warning

Diesel engine exhaust and some of its constituents are known to the State of California to cause cancer, birth defects, and other reproductive harm.

Battery posts, terminals and related accessories contain lead and lead compounds. **Wash hands after handling.**

Certified Engine Maintenance

Proper maintenance and repair is essential to keep the engine and machine systems operating correctly. As the heavy duty off-road diesel engine owner, you are responsible for the performance of the required maintenance listed in the Owner Manual, Operation and Maintenance Manual, and Service Manual.

It is prohibited for any person engaged in the business of repairing, servicing, selling, leasing, or trading engines or machines to remove, alter, or render inoperative any emission related device or element of design installed on or in an engine or machine that is in compliance with the regulations (40 CFR Part 89). Certain elements of the machine and engine such as the exhaust system, fuel system, electrical system, intake air system and cooling system may be emission related and should not be altered unless approved by Caterpillar.

Machine Capacity

Additional attachments or modifications may exceed machine design capacity which can adversely affect performance characteristics. Included would be stability and system certifications such as brakes, steering, and rollover protective structures (ROPS). Contact your Cat dealer for further information.

Cat Product Identification Number

Effective First Quarter 2001 the Cat Product Identification Number (PIN) has changed from 8 to 17 characters. In an effort to provide uniform equipment identification, Caterpillar and other construction equipment manufacturers are moving to comply with the latest version of the product identification numbering standard. Non-road machine PINs are defined by ISO 10261. The new PIN format will apply to all Cat machines and generator sets. The PIN plates and frame marking will display the 17 character PIN. The new format will look like the following:



Illustration 1

g00751314

Where:

1. Caterpillar's World Manufacturing Code (characters 1-3)
2. Machine Descriptor (characters 4-8)
3. Check Character (character 9)
4. Machine Indicator Section (MIS) or Product Sequence Number (characters 10-17). These were previously referred to as the Serial Number.

Machines and generator sets produced before First Quarter 2001 will maintain their 8 character PIN format.

<https://www.ebooklibonline.com>

Hello dear friend!

Thank you very much for reading.

Enter the link into your browser.

The full manual is available for immediate download.

<https://www.ebooklibonline.com>

Components such as engines, transmissions, axles, etc. and work tools will continue to use an 8 character Serial Number (S/N).

Product: BACKHOE LOADER

Model: 416D BACKHOE LOADER BFP

Configuration: 416D Backhoe Loader BFP00001-17198 (MACHINE) POWERED BY 3054 Engine

Operation and Maintenance Manual 416D Backhoe Loader

Media Number -SEBU7398-08

Publication Date -01/03/2015

Date Updated -03/03/2015

i01863082

Safety Messages

SMCS - 7000; 7405

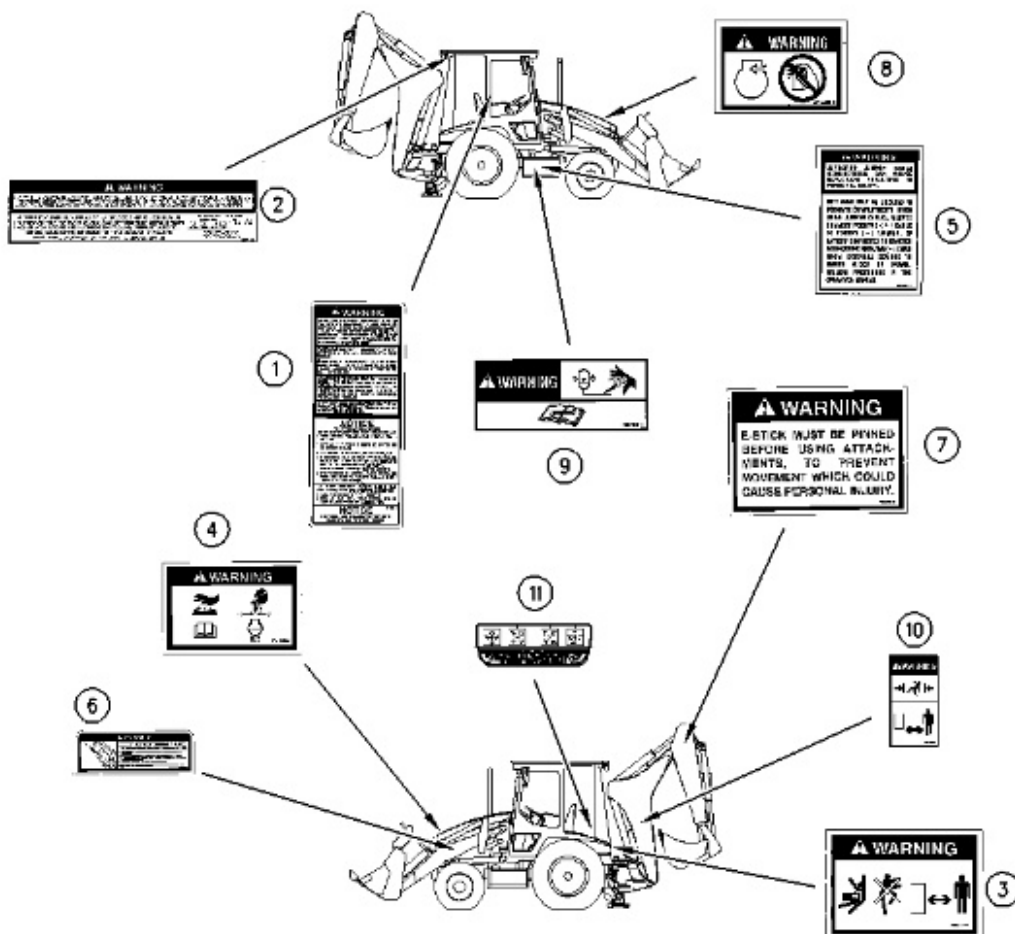

There are several specific safety messages on this machine. The exact location of the hazards and the description of the hazards are reviewed in this section. Please become familiarized with all safety messages.

Make sure that all of the safety messages are legible. Clean the safety messages or replace the safety messages if you cannot read the words. Replace the illustrations if the illustrations are not legible. When you clean the safety messages, use a cloth, water and soap. Do not use solvent, gasoline, or other harsh chemicals to clean the safety messages. Solvents, gasoline, or harsh chemicals could loosen the adhesive that secures the safety message. Loose adhesive will allow the safety message to fall.

Replace any safety message that is damaged, or missing. If a safety message is attached to a part that is replaced, install a safety message on the replacement part. Any Caterpillar dealer can provide new safety messages.

Do Not Operate (1)

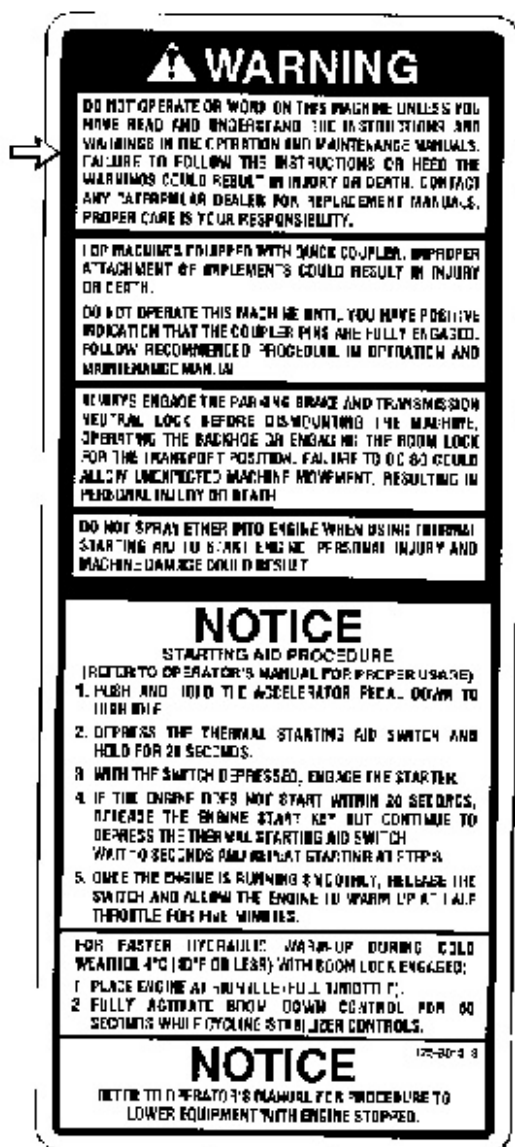

This safety message is located above the right side console.



Do not operate or work on this machine unless you have read and understand the instructions and warnings in the Operation and Maintenance Manuals. Failure to follow the instructions or heed the warnings could result in injury or death. Contact your Caterpillar dealer for replacement manuals. Proper care is your responsibility.

Improper Attachment of Work Tools (1)



This safety message is located above the right side console.



Improper attachment of implements could result in injury or death.

Do not operate this machine until you have positive indication that the coupler pins are fully engaged. Follow recommended procedure in Operation and Maintenance Manual.

Parking Brake and Transmission Neutral Lock (1)

WARNING

DO NOT OPERATE OR WORK ON THIS MACHINE UNLESS YOU HAVE READ AND UNDERSTAND THE INSTRUCTIONS AND WARNINGS IN THE OPERATION AND MAINTENANCE MANUAL. FAILURE TO FOLLOW THE INSTRUCTIONS OR HEED THE WARNINGS COULD RESULT IN INJURY OR DEATH. CONTACT ANY CAT/MILLARD DEALER FOR REPLACEMENT MANUALS. PROPER CARE IS YOUR RESPONSIBILITY.

FOR MACHINES EQUIPPED WITH DINCH COUPLER, IMPROPER ATTACHMENT OF IMPLEMENTS COULD RESULT IN INJURY OR DEATH.

DO NOT OPERATE THIS MACHINE UNTIL YOU HAVE POSITIVE INDICATION THAT THE COUPLER PINS ARE FULLY ENGAGED. FOLLOW RECOMMENDED PROCEDURE IN OPERATION AND MAINTENANCE MANUAL.

ALWAYS ENGAGE THE PARKING BRAKE AND TRANSMISSION NEUTRAL LOCK BEFORE DISMOUNTING THE MACHINE, OPERATING THE BACKHOE OR ENGAGING THE BOOM LOWER FOR THE TRANSPORT POSITION. FAILURE TO DO SO COULD ALLOW UNEXPECTED MACHINE MOVEMENT, RESULTING IN PERSONAL INJURY OR DEATH.

DO NOT SPRAY OILS INTO ENGINE WITH HIGH THERMAL STARTING AID TO START ENGINE. PERSONAL INJURY AND MACHINE DAMAGE COULD RESULT.

NOTICE

STARTING AID PROCEDURE
(REFER TO OPERATOR'S MANUAL FOR PROPER USAGE)

1. PUSH AND HOLD THE ACCELERATOR PEDAL DOWN TO 40% IDLE.
2. DEPRESS THE THERMAL STARTING AID SWITCH AND HOLD FOR 20 SECONDS.
3. WITH THE SWITCH DEPRESSSED, ENGAGE THE STARTER.
4. IF THE ENGINE DOES NOT START WITHIN 20 SECONDS, RELEASE THE ENGINE START KEY BUT CONTINUE TO DEPRESS THE THERMAL STARTING AID SWITCH. WAIT 10 SECONDS AND REPEAT STARTING AT STEP 3.
5. ONCE THE ENGINE IS RUNNING SMOOTHLY, RELEASE THE SWITCH AND ALLOW THE ENGINE TO WARM UP AT HALF THROTTLE FOR FIVE MINUTES.

FOR FASTER HYDRAULIC WARM-UP DURING COLD WEATHER 4°C (40°F) OR LOWER WITH BOOM LOCK ENGAGED.

1. PLACE ENGINE AT HIGH IDLE (FULL THROTTLE).
2. FULLY ACTIVATE BOOM DOWN CONTROL FOR 60 SECONDS WHILE CYCLING STABILIZER CONTROL 3.

NOTICE 873 0012 3

REFER TO OPERATOR'S MANUAL FOR PROCEDURE TO LOWER EQUIPMENT WITH ENGINE STOPPED.

This safety message is located above the right side console.



Always engage the parking brake and transmission neutral lock before dismounting the machine, operating the backhoe or engaging the boom lock for the transport position. Failure to do so could allow unexpected machine movement, resulting in personal injury or death.

Ether (1)

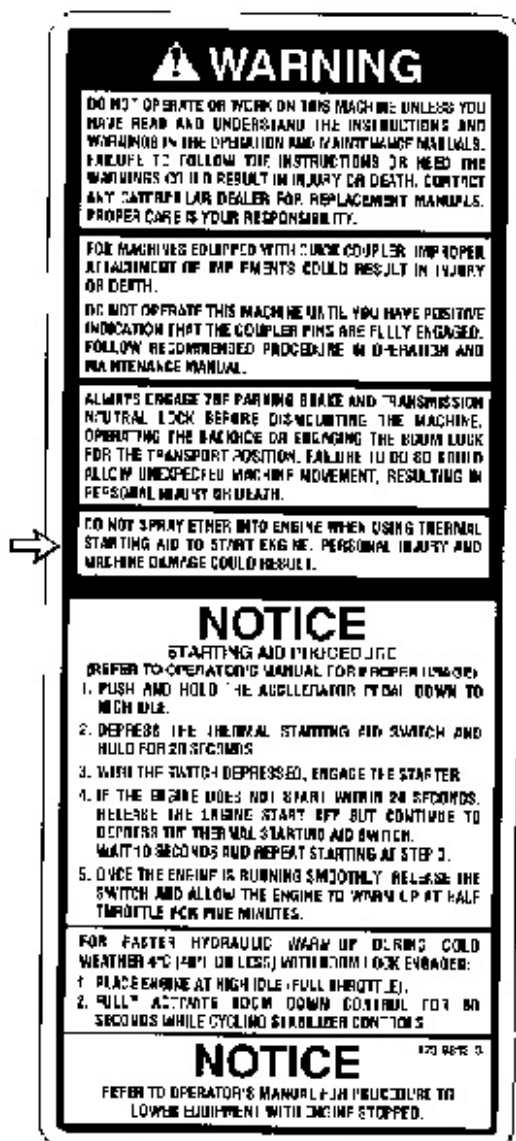

Illustration 6

g00937956

This safety message is located above the right side console.

 **WARNING**

Do not spray ether into engine when using thermal starting aid to start engine. Personal injury and machine damage could result. Follow procedure in the Operation and Maintenance Manual.

ROPS (2)



Illustration 7

g00937949

This safety message is located on the outside of the cab.

 **WARNING**

Structural damage, an overturn, modification, alteration, or improper repair can impair this structure's protection capability thereby voiding this certification. Do not weld on or drill holes in the structure. Consult a Caterpillar dealer to determine this structure's limitations without voiding its certification.

Keep Clear (3)



Illustration 8

g00937950

This safety message is located on the back of the cab.



Crush hazard; This is not an entrance or exit. Stay clear of this area when the machine is operating. Start and operate the backhoe from the operator seat only. Failure to follow these warnings could result in injury or death.

Pressurized System (4)

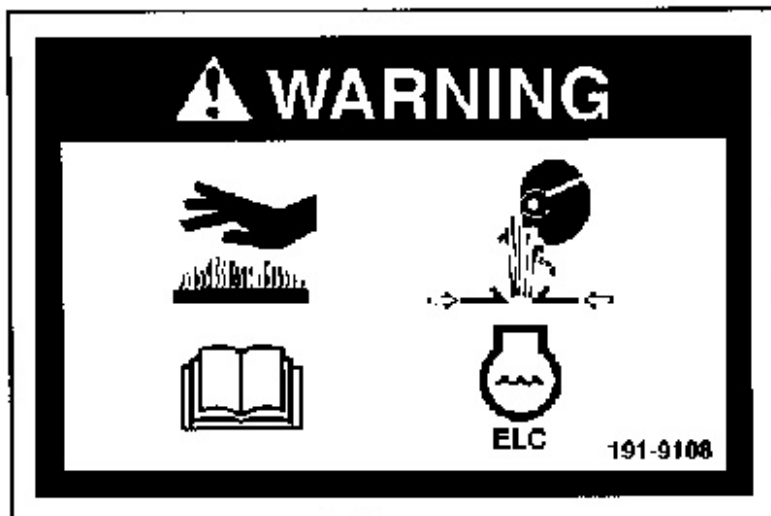

This safety message is located in two locations by the cooling system filler cap.



Pressurized system: Hot coolant can cause serious burn. To open cap, stop engine, wait until radiator is cool. Then loosen cap slowly to relieve the pressure.

Batteries (5)

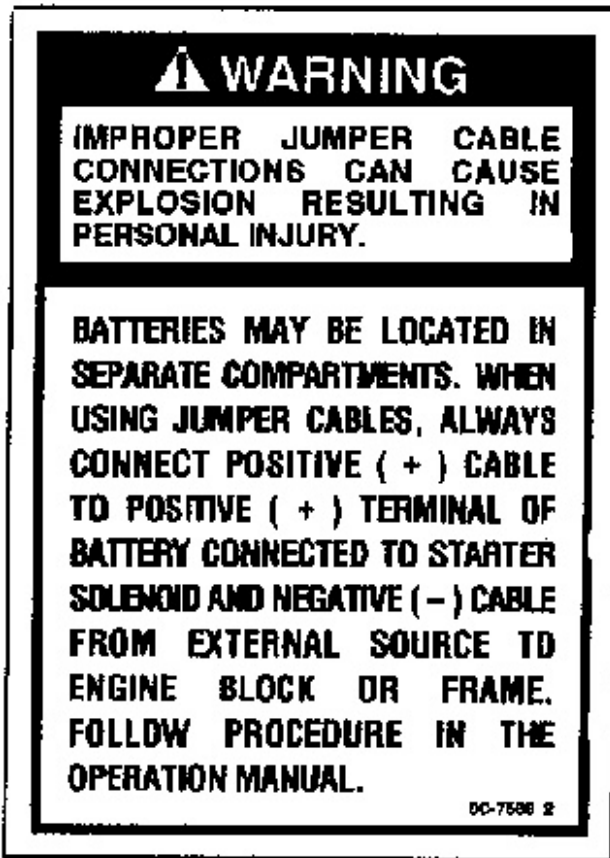

This safety message is located on the inside of the door for the battery compartment.



Improper jumper cable connections can cause explosion resulting in personal injury. Batteries may be located in separate compartments,

always connect positive (+) cable to positive (+) terminal of battery connected to starter solenoid and negative (-) cable from external source to engine block or frame.

Brace The Lift Cylinder on Single Tilt Machines (6)



Illustration 11

g00937954

This safety message (if equipped) is located on the loader lift arm by the brace for the loader lift arm.



When performing any work underneath a raised loader lift arm, the loader lift arm brace must be in place. Install the loader lift arm brace as follows.

1. Empty loader bucket. Remove pin that secures loader lift arm brace to left loader arm. Raise loader arms to maximum height with the bucket in the dump position.
2. Position service brace over left lift cylinder with flat end against cylinder end.
3. Push pin through holes of loader lift arm brace and install cotter pin.
4. Slowly lower loader arms until brace contacts the top of the lift cylinder and bosses on loader arm.
5. To remove loader lift arm brace, reverse procedure.

Failure to follow this procedure can result in death or serious injury if the loader arms are accidentally lowered.

Extendable Stick (7) (If Equipped)

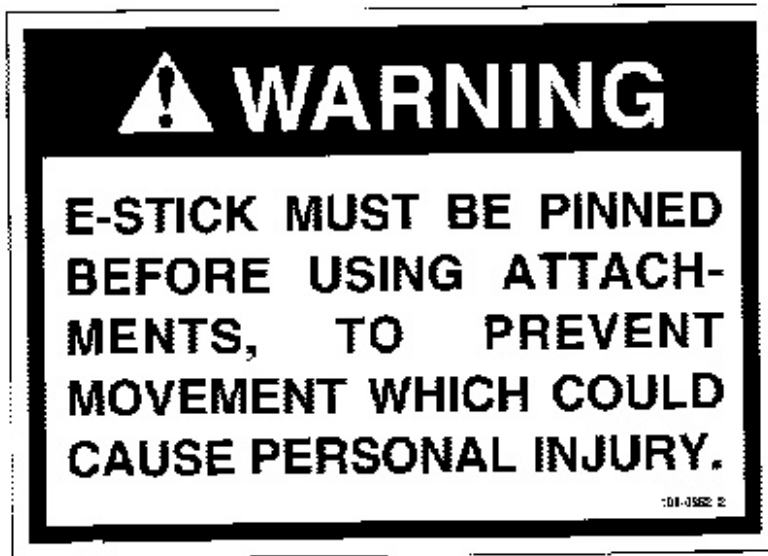

Illustration 12

g00937955

This safety message is located by the connectors for the auxiliary hydraulic hoses.



E-stick must be pinned before using attachments, to prevent movement which could cause personal injury.

No Ether In Air Inlet (8)



Illustration 13

g00924889

This safety message is located on the valve cover.



If equipped with an air inlet heater (AIH) for cold weather starting, do not use aerosol types of starting aids such as ether. Such use could result in an explosion and personal injury.

High Pressure Accumulator (9)

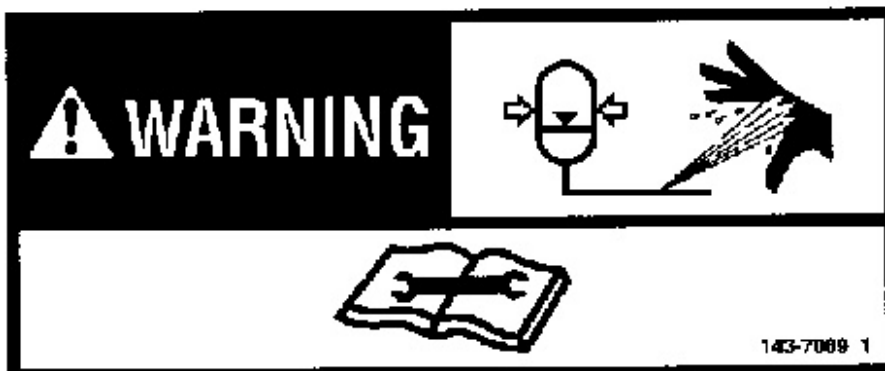

This safety message is located on the accumulator for the loader. This accumulator is located behind the battery compartment.



Hydraulic accumulator contains gas and oil under high pressure. Improper removal or repair procedures could cause severe injury. To remove or repair, instructions in the service manual must be followed. Special equipment is required for testing and charging.

Crush Hazard (10)

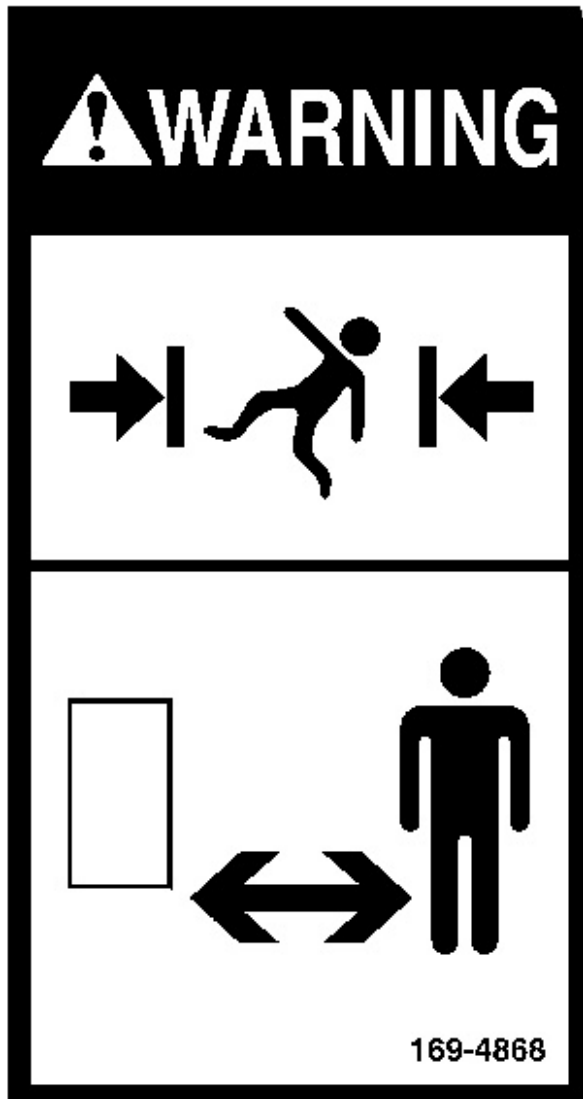

This safety message is located on the boom above the boom foot pin and sideways from the bottom wrapper plate.



Crushing Hazard! Stay back a safe distance. There is no clearance for a person in this area when the machine turns. Failure to follow these instructions could cause serious injury or death.

Control Pattern (11) (If Equipped)

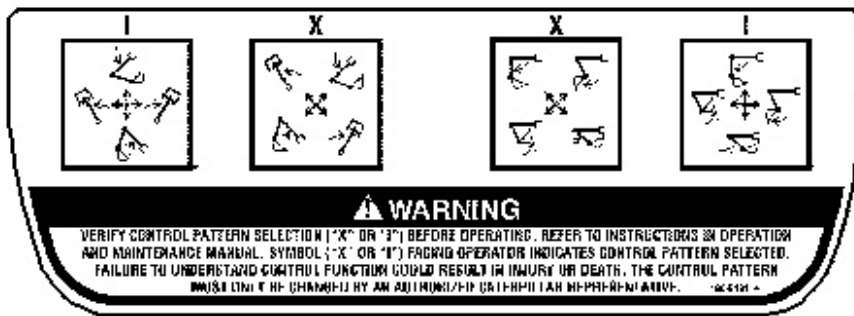

This safety message is located on the rear console.



Verify control pattern selection ("X" or "I") before operating. Refer to instructions in operation and maintenance manual. Symbol ("X" or "I") facing operator indicates control pattern selected. Failure to understand control function could result in injury or death. The control pattern must only be changed by an authorized Caterpillar representative.

Product: BACKHOE LOADER

Model: 416D BACKHOE LOADER BFP

Configuration: 416D Backhoe Loader BFP00001-17198 (MACHINE) POWERED BY 3054 Engine

Operation and Maintenance Manual 416D Backhoe Loader

Media Number -SEBU7398-08

Publication Date -01/03/2015

Date Updated -03/03/2015

i01864390

Additional Messages

SMCS - 7000; 7405

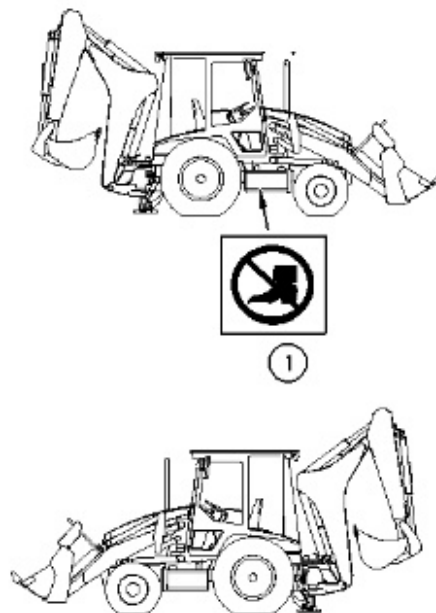

Illustration 1

g00950522

No Step (1)



Illustration 2

g00936182

This safety message is located inside the battery box.

 **CAUTION**

Do not step here. Stepping here could cause damage to the work tool and personal injury.

Product: BACKHOE LOADER

Model: 416D BACKHOE LOADER BFP

Configuration: 416D Backhoe Loader BFP00001-17198 (MACHINE) POWERED BY 3054 Engine

Operation and Maintenance Manual 416D Backhoe Loader

Media Number -SEBU7398-08

Publication Date -01/03/2015

Date Updated -03/03/2015

i07500894

General Hazard Information

SMCS - 7000

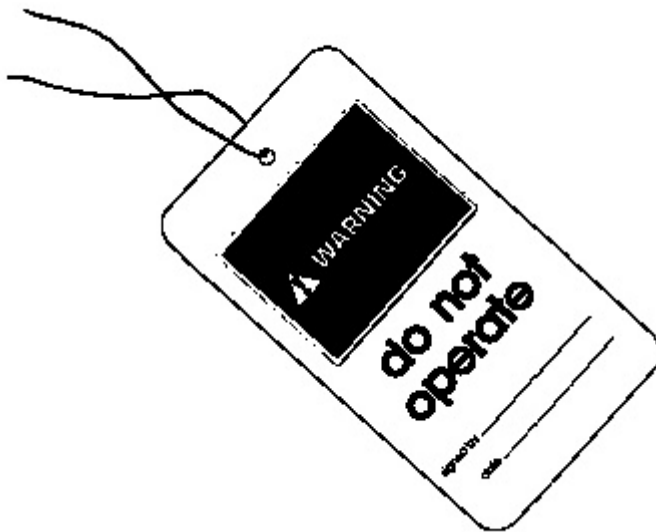

Illustration 1

g00104545

Typical example

Attach a "Do Not Operate" warning tag or a similar warning tag to the start switch or to the controls. Attach the warning tag before you service the equipment or before you repair the equipment. Warning tag SEHS7332 is available from your Cat dealer.



Operating the machine while distracted can result in the loss of machine control. Use extreme caution when using any device while operating the



Suggest:

For more complete manuals. Please go to the home page.

<https://www.ebooklibonline.com>

If the above button click is invalid. Please download this document first, and then click the above link to download the complete manual.

Thank you so much for reading

machine. Operating the machine while distracted can result in personal injury or death.

Know the width of your equipment in order to maintain proper clearance when you operate the equipment near fences or near boundary obstacles.

Be aware of high voltage power lines and power cables that are buried. If the machine comes in contact with these hazards, serious injury or death may occur from electrocution.

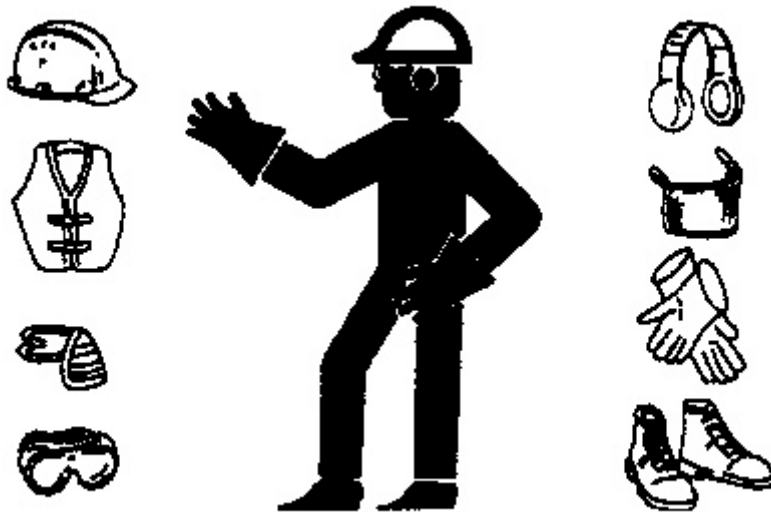

Illustration 2

g00702020

Wear a hard hat, protective glasses, and other protective equipment, as required.

Do not wear loose clothing or jewelry that can snag on controls or on other parts of the equipment.

Make sure that all protective guards and all covers are secured in place on the equipment.

Keep the equipment free from foreign material. Remove debris, oil, tools, and other items from the deck, from walkways, and from steps.

Secure all loose items such as lunch boxes, tools, and other items that are not a part of the equipment.

Know the appropriate work site hand signals and the personnel that are authorized to give the hand signals. Accept hand signals from one person only.

Do not smoke when you service an air conditioner. Also, do not smoke if refrigerant gas may be present. Inhaling the fumes that are released from a flame that contacts air conditioner refrigerant can cause bodily harm or death. Inhaling gas from air conditioner refrigerant through a lighted cigarette can cause bodily harm or death.

Never put maintenance fluids into glass containers. Drain all liquids into a suitable container.

Obey all local regulations for the disposal of liquids.

Use all cleaning solutions with care. Report all necessary repairs.

Do not allow unauthorized personnel on the equipment.

Unless you are instructed otherwise, perform maintenance with the equipment in the servicing position. Refer to Operation and Maintenance Manual for the procedure for placing the equipment in the servicing position.

When you perform maintenance above ground level, use appropriate devices such as ladders or man lift machines. If equipped, use the machine anchorage points and use approved fall arrest harnesses and lanyards.

Pressurized Air and Water

Pressurized air and/or water can cause debris and/or hot water to be blown out. The debris and/or hot water could result in personal injury.

When pressurized air and/or pressurized water is used for cleaning, wear protective clothing, protective shoes, and eye protection. Eye protection includes goggles or a protective face shield.

The maximum air pressure for cleaning purposes must be reduced to 205 kPa (30 psi) when the nozzle is deadheaded and the nozzle is used with an effective chip deflector and personal protective equipment. The maximum water pressure for cleaning purposes must be below 275 kPa (40 psi).

Avoid direct spraying of water on electrical connectors, connections, and components. When using air for cleaning, allow the machine to cool to reduce the possibility of fine debris igniting when re-deposited on hot surfaces.

Trapped Pressure

Pressure can be trapped in a hydraulic system. Releasing trapped pressure can cause sudden machine movement or attachment movement. Use caution if you disconnect hydraulic lines or fittings. High-pressure oil that is released can cause a hose to whip. High-pressure oil that is released can cause oil to spray. Fluid penetration can cause serious injury and possible death.

Fluid Penetration

Pressure can be trapped in the hydraulic circuit long after the machine has been stopped. The pressure can cause hydraulic fluid or items such as pipe plugs to escape rapidly if the pressure is not relieved correctly.

Do not remove any hydraulic components or parts until pressure has been relieved or personal injury may occur. Do not disassemble any hydraulic components or parts until pressure has been relieved or personal injury may occur. Refer to the Service Manual for any procedures that are required to relieve the hydraulic pressure.

<https://www.ebooklibonline.com>

Hello dear friend!

Thank you very much for reading.

Enter the link into your browser.

The full manual is available for immediate download.

<https://www.ebooklibonline.com>