

Product: EXCAVATOR

Model: 315C EXCAVATOR AKE

Configuration: 315C & 315C L Excavators AKE00001-UP (MACHINE) POWERED BY 3046 Engine

## **Operation and Maintenance Manual 315C Excavator**

Media Number -SEBU7425-06

Publication Date -01/04/2007

Date Updated -03/04/2007

s00037320

## **Foreword**

SMCS - 7606

## **Literature Information**

This manual should be stored in the operator's compartment in the literature holder or seat back literature storage area.

This manual contains safety information, operation instructions, transportation information, lubrication information and maintenance information.

Some photographs or illustrations in this publication show details or attachments that can be different from your machine. Guards and covers might have been removed for illustrative purposes.

Continuing improvement and advancement of product design might have caused changes to your machine which are not included in this publication. Read, study and keep this manual with the machine.

Whenever a question arises regarding your machine, or this publication, please consult your Cat dealer for the latest available information.

## **Safety**

The safety section lists basic safety precautions. In addition, this section identifies the text and locations of warning signs and labels used on the machine.

Read and understand the basic precautions listed in the safety section before operating or performing lubrication, maintenance and repair on this machine.

## **Operation**

The operation section is a reference for the new operator and a refresher for the experienced operator. This section includes a discussion of gauges, switches, machine controls, attachment controls, transportation and towing information.

Photographs and illustrations guide the operator through correct procedures of checking, starting, operating and stopping the machine.

Operating techniques outlined in this publication are basic. Skill and techniques develop as the operator gains knowledge of the machine and its capabilities.

## Maintenance

The maintenance section is a guide to equipment care. The Maintenance Interval Schedule (MIS) lists the items to be maintained at a specific service interval. Items without specific intervals are listed under the "When Required" service interval. The Maintenance Interval Schedule lists the page number for the step-by-step instructions required to accomplish the scheduled maintenance. Use the Maintenance Interval Schedule as an index or "one safe source" for all maintenance procedures.

### Maintenance Intervals

Use the service hour meter to determine servicing intervals. Calendar intervals shown (daily, weekly, monthly, etc.) can be used instead of service hour meter intervals if they provide more convenient servicing schedules and approximate the indicated service hour meter reading. Recommended service should always be performed at the interval that occurs first.

Under extremely severe, dusty or wet operating conditions, more frequent lubrication than is specified in the maintenance intervals chart might be necessary.

Perform service on items at multiples of the original requirement. For example, at every 500 service hours or 3 months, also service those items listed under every 250 service hours or monthly and every 10 service hours or daily.

## California Proposition 65 Warning

Diesel engine exhaust and some of its constituents are known to the State of California to cause cancer, birth defects, and other reproductive harm.

Battery posts, terminals and related accessories contain lead and lead compounds. **Wash hands after handling.**

## Certified Engine Maintenance

Proper maintenance and repair is essential to keep the engine and machine systems operating correctly. As the heavy duty off-road diesel engine owner, you are responsible for the performance of the required maintenance listed in the Owner Manual, Operation and Maintenance Manual, and Service Manual.

It is prohibited for any person engaged in the business of repairing, servicing, selling, leasing, or trading engines or machines to remove, alter, or render inoperative any emission related device or element of design installed on or in an engine or machine that is in compliance with the

regulations (40 CFR Part 89). Certain elements of the machine and engine such as the exhaust system, fuel system, electrical system, intake air system and cooling system may be emission related and should not be altered unless approved by Caterpillar.

## Machine Capacity

Additional attachments or modifications may exceed machine design capacity which can adversely affect performance characteristics. Included would be stability and system certifications such as brakes, steering, and rollover protective structures (ROPS). Contact your Cat dealer for further information.

## Cat Product Identification Number

Effective First Quarter 2001 the Cat Product Identification Number (PIN) has changed from 8 to 17 characters. In an effort to provide uniform equipment identification, Caterpillar and other construction equipment manufacturers are moving to comply with the latest version of the product identification numbering standard. Non-road machine PINs are defined by ISO 10261. The new PIN format will apply to all Cat machines and generator sets. The PIN plates and frame marking will display the 17 character PIN. The new format will look like the following:



---

Illustration 1

g00751314

Where:

1. Caterpillar's World Manufacturing Code (characters 1-3)
2. Machine Descriptor (characters 4-8)
3. Check Character (character 9)
4. Machine Indicator Section (MIS) or Product Sequence Number (characters 10-17). These were previously referred to as the Serial Number.

**<https://www.ebooklibonline.com>**

Hello dear friend!

Thank you very much for reading.

Enter the link into your browser.

The full manual is available for immediate download.

**<https://www.ebooklibonline.com>**

Machines and generator sets produced before First Quarter 2001 will maintain their 8 character PIN format.

Components such as engines, transmissions, axles, etc. and work tools will continue to use an 8 character Serial Number (S/N).

---

Product: EXCAVATOR

Model: 315C EXCAVATOR AKE

Configuration: 315C & 315C L Excavators AKE00001-UP (MACHINE) POWERED BY 3046 Engine

## **Operation and Maintenance Manual 315C Excavator**

Media Number -SEBU7425-06

Publication Date -01/04/2007

Date Updated -03/04/2007

i02242171

## **Safety Messages - Arrangement II**

SMCS - 7000; 7405

S/N - AKE1-UP

S/N - CJC1-UP

There are several specific safety messages on this machine. The exact location of the hazards and the description of the hazards are reviewed in this section. Please become familiarized with all safety messages.

Make sure that all of the safety messages are legible. Clean the safety messages or replace the safety messages if you cannot read the words. Replace the illustrations if the illustrations are not visible. When you clean the safety messages, use a cloth, water and soap. Do not use solvent, gasoline, or other harsh chemicals to clean the safety messages. Solvents, gasoline, or harsh chemicals could loosen the adhesive that secures the safety message. Loose adhesive will allow the safety message to fall.

Replace any safety message that is damaged, or missing. If a safety message is attached to a part that is replaced, install a safety message on the replacement part. Any Caterpillar dealer can provide new safety messages.

---

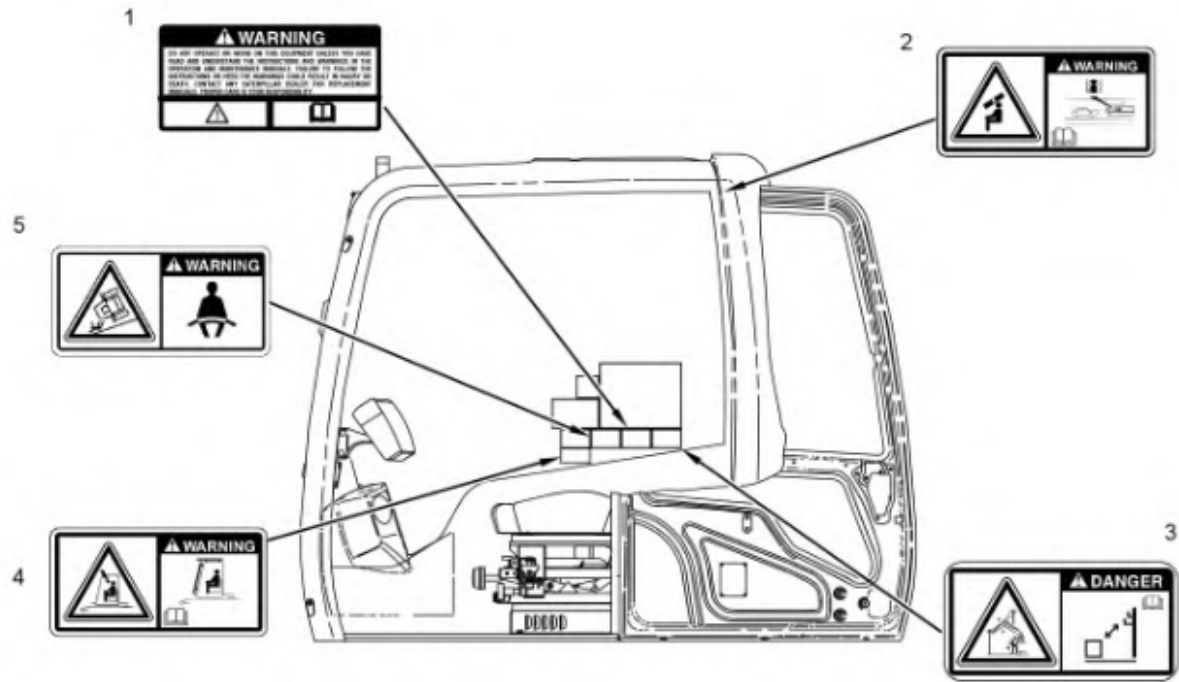

---

Illustration 2

g01130132

---

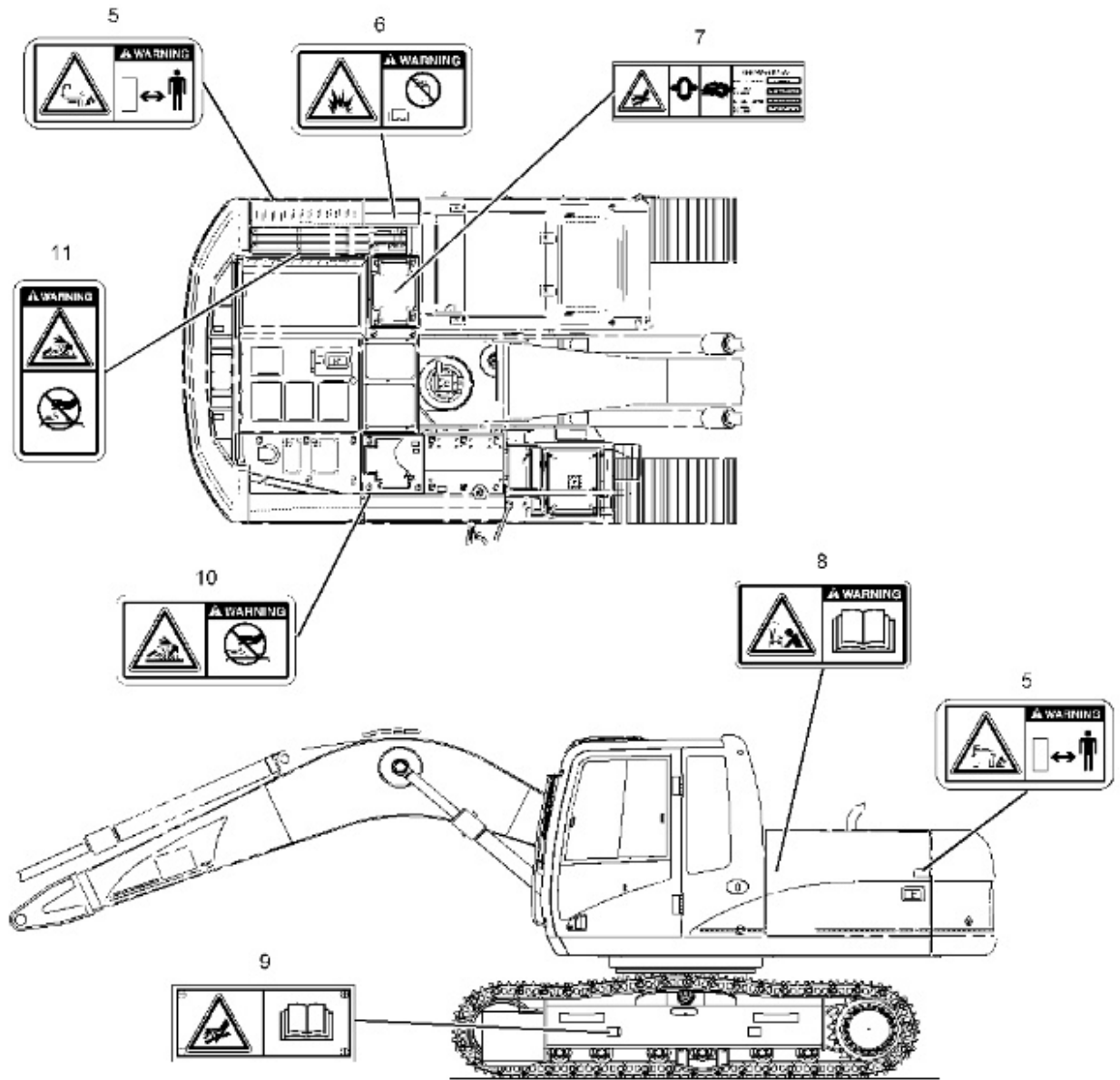

---

Illustration 3

g01119705

**(1) Do Not Operate**

---



Illustration 4

g00930652

This safety message is located in the cab.

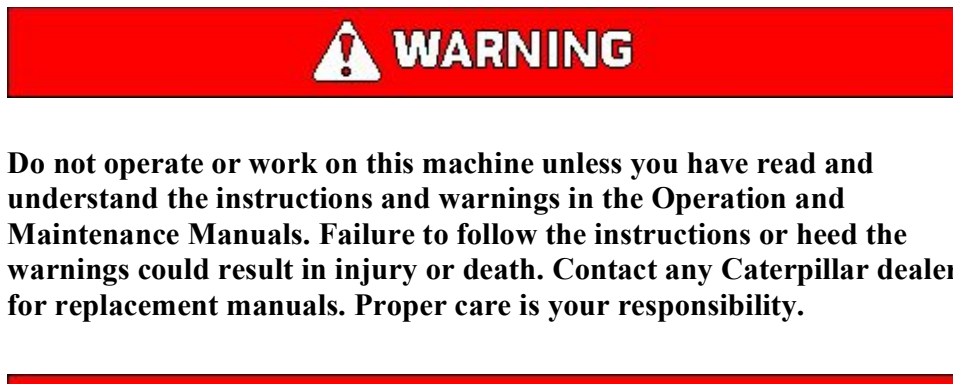

## (2) Crushing hazard



Illustration 5

g01067551

This safety message is located in the cab.

**! WARNING**

Personal injury can result if the window is not latched in the overhead position; ensure the auto lock is engaged.

---

**(3) Seat Belt**

---



Illustration 6

g01067563

This safety message is located in the cab.

**! WARNING**

A seat belt should be worn at all times during machine operation to prevent serious injury or death in the event of an accident or machine overturn. Failure to wear a seat belt during machine operation may result in serious injury or death.

---

**(4) Crushing Hazard**

---



---

Illustration 7

g01130693

This safety message is located in the cab.



**The impact from objects that strike the front of the cab or the top of the cab could result in a crushing hazard with the potential for personal injury or death.**

**The front guard and the top guard should be installed on the cab for applications where the hazard of falling objects exist. Read the Operation and Maintenance Manual.**

---

## **(5) Electrical Power Lines**



---

Illustration 8

g01067566

This safety message is located in the cab.

## DANGER

**Electrocution Hazard! Keep the machine and attachments a safe distance from electrical power. Stay clear 3 m (10 ft) plus twice the line insulator length. Read and understand the instructions and warnings in the Operation and Maintenance Manual. Failure to follow the instructions and warnings will cause serious injury or death**

---

Refer to Operation and Maintenance Manual, "Specifications" for further information.

### **(5) Crushing Hazard**

---



Illustration 9

g01067376

This safety message is located on both sides of the rear of the machine.

## WARNING

**Machine swings. Stay back. Crushing hazard could cause serious injury or death.**

---

### **(6) Aerosol Starting Aid**

---



Illustration 10

g01067463

This safety message is located inside the left access door.



**Explosion hazard! Do not use ether! This machine is equipped with an air inlet heater. Using ether can create explosions or fires that can cause personal injury or death. Read and follow the starting procedure in the Operation and Maintenance Manual.**

Refer to Operation and Maintenance Manual, "Engine Starting" for further information.

**(7) High Pressure Gas**

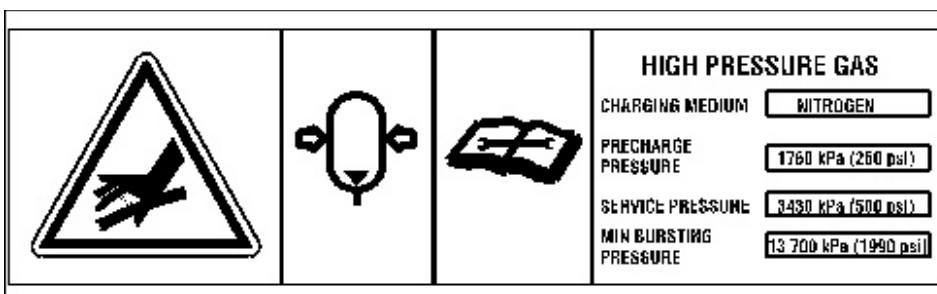

Illustration 11

g01067549

This safety message is located on the accumulator.

**! WARNING**

**This system contains high pressure gas. Failure to follow the instructions and warnings could cause an explosion, resulting in possible injury or death.**

**Do not expose to fire. Do not weld. Do not drill. Relieve pressure before discharging.**

**See Operation and Maintenance Manual for charging and discharging. See your Caterpillar Dealer for tools and detailed information.**

---

**(8) Jump Start Cables**

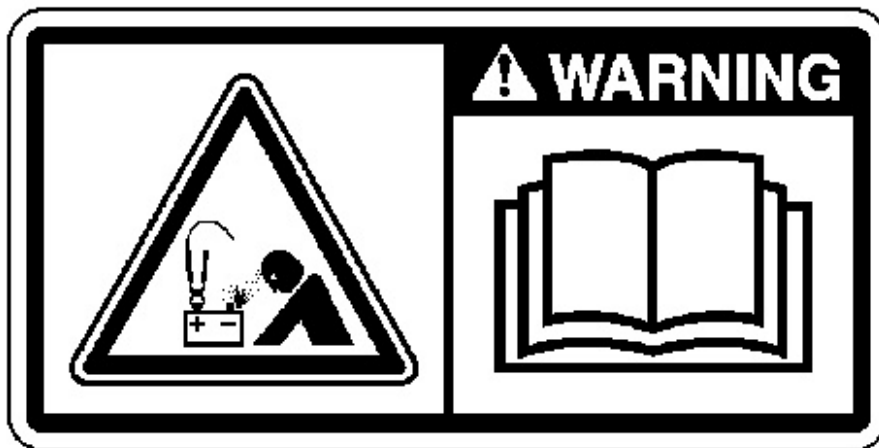

---

Illustration 12

g01067366

This safety message is located inside the left access door.

**! WARNING**

**Explosion Hazard! Improper jumper cable connections can cause an explosion resulting in serious injury or death. Batteries may be located in separate compartments. Refer to the Operation and Maintenance Manual for the correct jump starting procedure.**

---

Refer to Operation and Maintenance Manual, "Engine Starting with Jump Start Cables" for further information.

### (9) High Pressure Cylinder

---

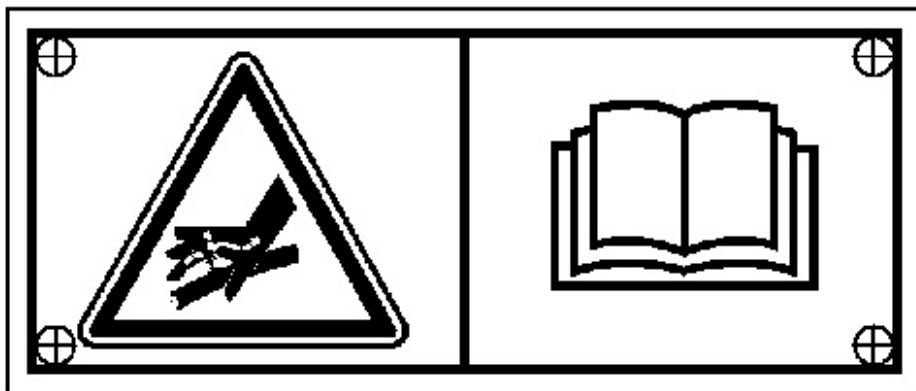

---

Illustration 13

g01076729

This safety message is located on the track adjuster.



**High Pressure Cylinder. Do not remove any parts from the cylinder until all of the pressure has been relieved. This will prevent possible personal injury or death.**

---

Refer to Operation and Maintenance Manual, "Track Adjustment - Adjust" for the proper service procedure.

### (10) Relieve Hydraulic Tank Pressure

---



---

Illustration 14

g01067344

This safety message is located on top of the hydraulic tank.



**HYDRAULIC TANK**

**RELIEVE TANK PRESSURE WITH ENGINE OFF BY REMOVING  
CAP SLOWLY TO PREVENT BURNS FROM HOT OIL.**

---

**(11) Pressurized System**

---



---

Illustration 15

g01109238

This safety message is located on the radiator.



**Pressurized system! Hot coolant can cause serious burns, injury or death. To open the cooling system filler cap, stop the engine and wait until the cooling system components are cool. Loosen the cooling system pressure cap slowly in order to relieve the pressure. Read and understand the Operation and Maintenance Manual before performing any cooling system maintenance.**

---

Refer to Operation and Maintenance Manual, "Cooling System Coolant Level - Check" for further information.

---

Product: EXCAVATOR

Model: 315C EXCAVATOR AKE

Configuration: 315C & 315C L Excavators AKE00001-UP (MACHINE) POWERED BY 3046 Engine

## **Operation and Maintenance Manual 315C Excavator**

Media Number -SEBU7425-06

Publication Date -01/04/2007

Date Updated -03/04/2007

i02211806

# **Safety Messages - Arrangement I**

**SMCS - 7000; 7405**

There are several specific safety messages on this machine. The exact location of the hazards and the description of the hazards are reviewed in this section. Please become familiarized with all safety messages.

Make sure that all of the safety messages are legible. Clean the safety messages or replace the safety messages if you cannot read the words. Replace the illustrations if the illustrations are not visible. When you clean the safety messages, use a cloth, water and soap. Do not use solvent, gasoline, or other harsh chemicals to clean the safety messages. Solvents, gasoline, or harsh chemicals could loosen the adhesive that secures the safety message. Loose adhesive will allow the safety message to fall.

Replace any safety message that is damaged, or missing. If a safety message is attached to a part that is replaced, install a safety message on the replacement part. Any Caterpillar dealer can provide new safety messages.

### **Do Not Operate**

---

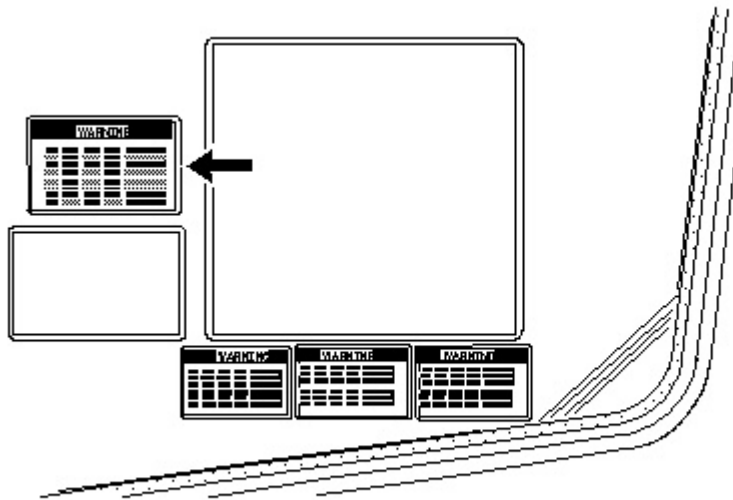
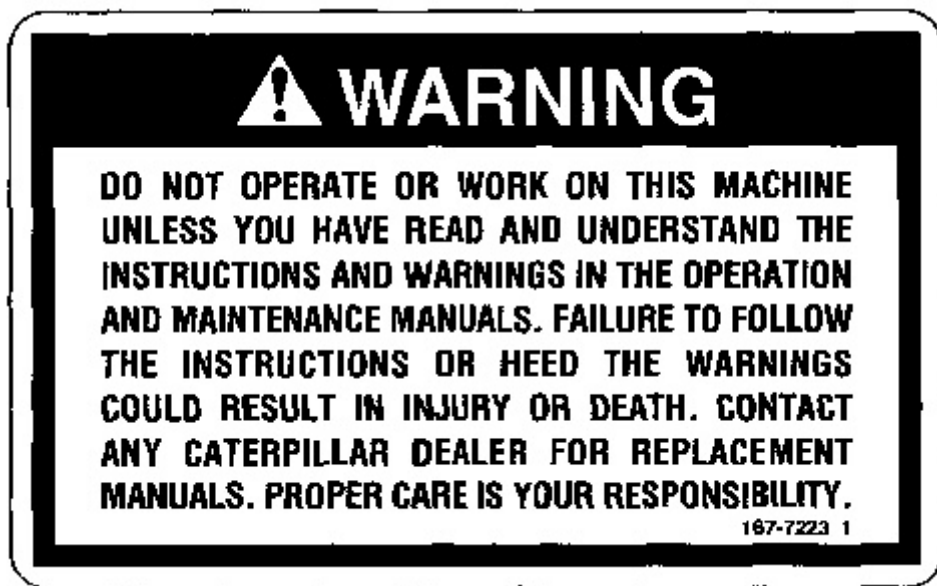

Illustration 1

g00103455

This safety message is located in the cab.



g00684449



**DO NOT OPERATE OR WORK ON THIS MACHINE UNLESS YOU HAVE READ AND UNDERSTAND THE INSTRUCTIONS AND WARNINGS IN THE OPERATION AND MAINTENANCE MANUALS. FAILURE TO FOLLOW THE INSTRUCTIONS OR HEED THE WARNINGS COULD RESULT IN INJURY OR DEATH.**

CONTACT ANY CATERPILLAR DEALER FOR REPLACEMENT  
MANUALS. PROPER CARE IS YOUR RESPONSIBILITY.

---

## Electrical Power Lines

---

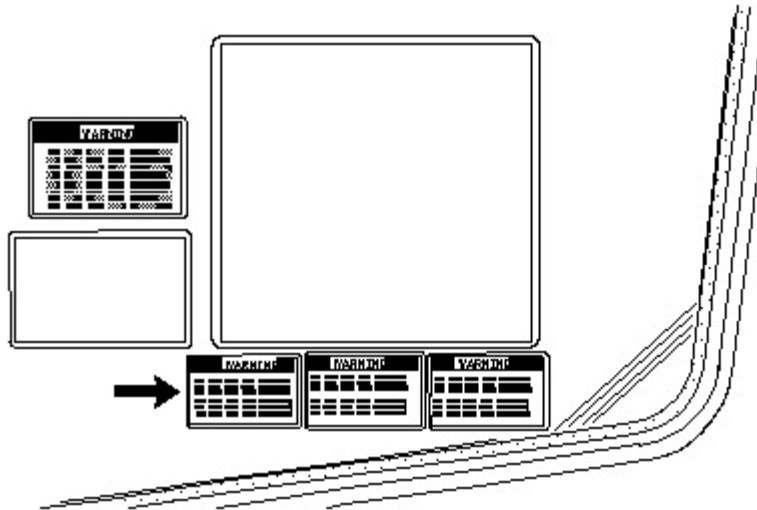

---

Illustration 2

g00103447

This safety message is located in the cab.

---

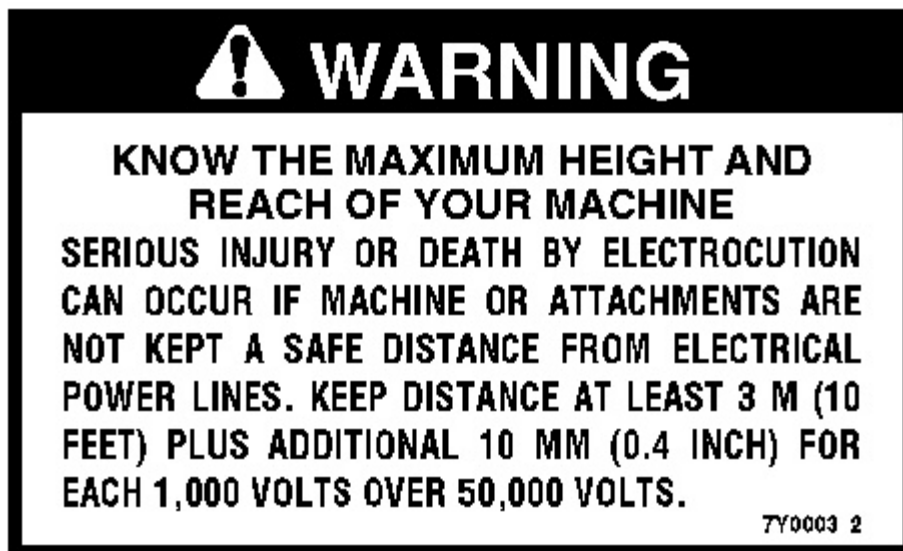

---

g00100702



**Suggest:**

**For more complete manuals. Please go to the home page.**

**<https://www.ebooklibonline.com>**

**If the above button click is invalid. Please download this document first, and then click the above link to download the complete manual.**

**Thank you so much for reading**



## WARNING

**Know the maximum height and reach of your machine. Serious injury or death by electrocution can occur if machine, work tools, or attachments are not kept a safe distance from electrical power lines. Keep distance at least 3 m (10 ft) Plus additional 10 mm (.4 inch) for each 1,000 volts over 50,000 volts.**

---

Refer to Operation and Maintenance Manual, "Specifications" for further information.

### Crushing Hazard

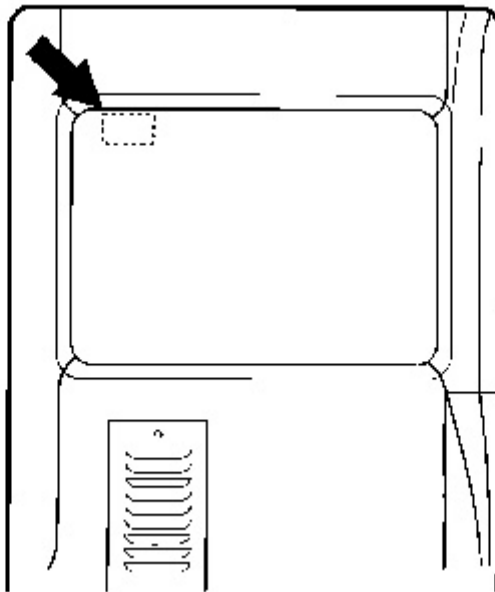

---

Illustration 3

g00683827

This safety message is located in the cab.

---



g00684465



**Personal injury can result if the window is not latched in the overhead position; ensure the auto lock is engaged.**

### Automatic Engine Speed Control (AEC)

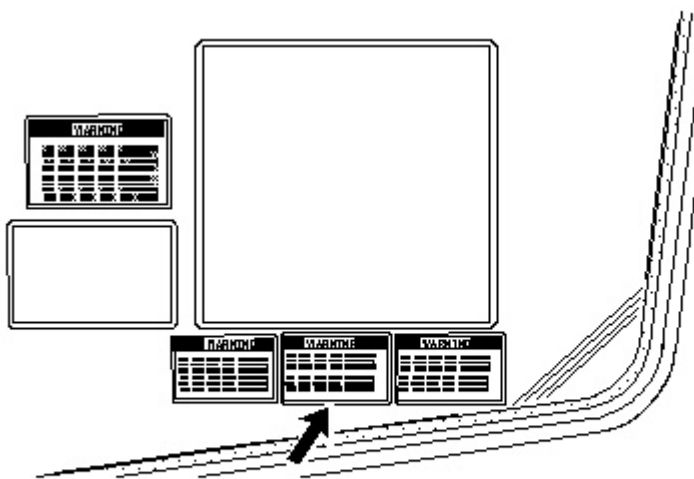

**<https://www.ebooklibonline.com>**

Hello dear friend!

Thank you very much for reading.

Enter the link into your browser.

The full manual is available for immediate download.

**<https://www.ebooklibonline.com>**