

Product: EXCAVATOR

Model: 307-A EXCAVATOR 2PM

Configuration: 307 TRACK-TYPE EXCAVATOR 2PM00001-UP (MACHINE) POWERED BY 4D32 ENGINE

## **Operation and Maintenance Manual 307 EXCAVATORS**

Media Number -SEBU6835-02

Publication Date -01/10/1999

Date Updated -30/01/2002

### **Foreword**

SMCS - 7606

#### **Literature Information**

This manual should be stored in the operator's compartment in the literature holder or seat back literature storage area.

This manual contains safety, operation, transportation, lubrication and maintenance information.

Some photographs or illustrations in this publication show details or attachments that can be different from your machine. Guards and covers might have been removed for illustrative purposes.

Continuing improvement and advancement of product design might have caused changes to your machine which are not included in this publication. Read, study and keep this manual with the machine.

Whenever a question arises regarding your machine, or this publication, please consult your Caterpillar dealer for the latest available information.

#### **Safety**

The Safety Section lists basic safety precautions. In addition, this section identifies the text and locations of warning signs and labels used on the machine.

Read and understand the basic precautions listed in the Safety Section before operating or performing lubrication, maintenance and repair on this machine.

#### **Operation**

The Operation Section is a reference for the new operator and a refresher for the experienced one. This section includes a discussion of gauges, switches, machine controls, implement controls, transportation and towing information.

Photographs and illustrations guide the operator through correct procedures of checking, starting, operating and stopping the machine.

Operating techniques outlined in this publication are basic. Skill and techniques develop as the operator gains knowledge of the machine and its capabilities.

## **Maintenance**

The Maintenance Section is a guide to equipment care. The illustrated, step-by-step instructions are grouped by servicing intervals. Items without specific intervals are listed under When Required topics. Items in the Maintenance Intervals chart are referenced to detailed instructions that follow.

### **Maintenance Intervals**

Use the service hour meter to determine servicing intervals. Calendar intervals shown (daily, weekly, monthly, etc.) can be used instead of service hour meter intervals if they provide more convenient servicing schedules and approximate the indicated service hour meter reading. Recommended service should always be performed at the interval that occurs first.

Under extremely severe, dusty or wet operating conditions, more frequent lubrication than is specified in the Maintenance Intervals chart might be necessary.

Perform service on items at multiples of the original requirement. For example, at Every 500 Service Hours or 3 Months, also service those items listed under Every 250 Service Hours or Monthly, Every 100 Service Hours or 2 Weeks, Every 50 Service Hours or Weekly and Every 10 Service Hours or Daily.

## **Machine Description**



This machine is equipped with a 4D32 direct injection engine and other specifically developed systems and components such as power mode choice system, work mode choice system, etc. As an option, two-speed travel motor, hydraulic offset boom, blade, etc. are available. The machine is designed primarily for excavating and loading material.

## **California**

### **Proposition 65 Warning**

Diesel engine exhaust and some of its constituents are known to the state of California to cause cancer, birth defects, and other reproductive harm.

---

Product: EXCAVATOR

Model: 307-A EXCAVATOR 2PM

Configuration: 307 TRACK-TYPE EXCAVATOR 2PM00001-UP (MACHINE) POWERED BY 4D32 ENGINE

## Operation and Maintenance Manual 307 EXCAVATORS

Media Number -SEBU6835-02

Publication Date -01/10/1999

Date Updated -30/01/2002

## Safety

SMCS - 7606

### Warning Signs and Labels

There are several specific safety signs on your machine. Their exact location and description of the hazard are reviewed in this section. Please take the time to familiarize yourself with these safety signs.

Make sure that you can read all safety signs. Clean or replace these if you cannot read the words or see the pictures. When cleaning the labels use a cloth, water and soap. Do not use solvent, gasoline, etc.

You must replace a label if it is damaged, missing or cannot be read. If a label is on a part that is replaced, make sure a new label is installed on the replaced part. See your Caterpillar dealer for new labels.



**Do not operate or work on this machine unless you have read and understand the instructions and warnings in the Operation and Maintenance Manual. Failure to follow the instructions or heed the warnings could result in injury or death. Contact any Caterpillar dealer for replacement manuals. Proper care is your responsibility.**

---

**<https://www.ebooklibonline.com>**

Hello dear friend!

Thank you very much for reading.

Enter the link into your browser.

The full manual is available for immediate download.

**<https://www.ebooklibonline.com>**

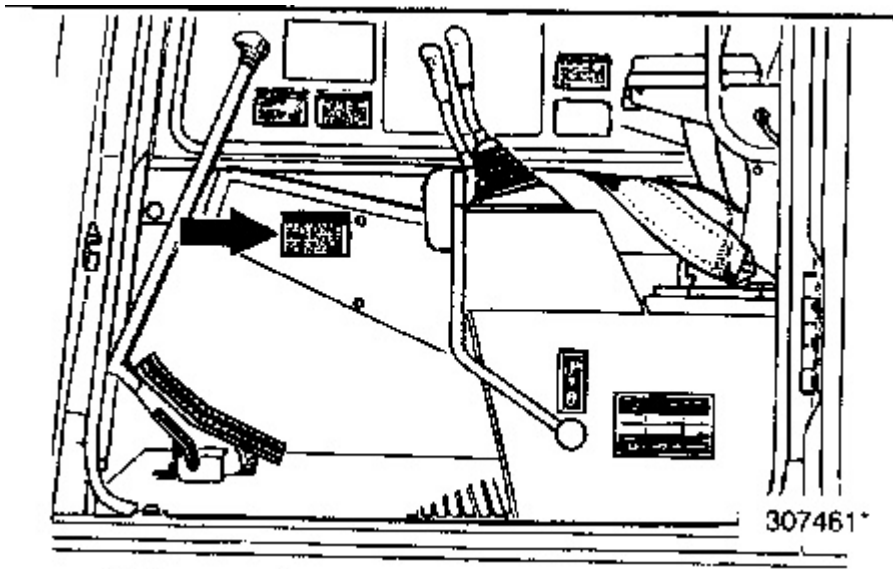

Attached to the right console.

 **WARNING**

**Know the maximum height and reach of your machine. Serious injury or death by electrocution can occur if machine or attachments are not kept a safe distance from electrical power lines. Keep distance at least 3 m (10 feet) plus additional 10 mm (0.4 inch) for each 1,000 volts over 50,000 volts.**

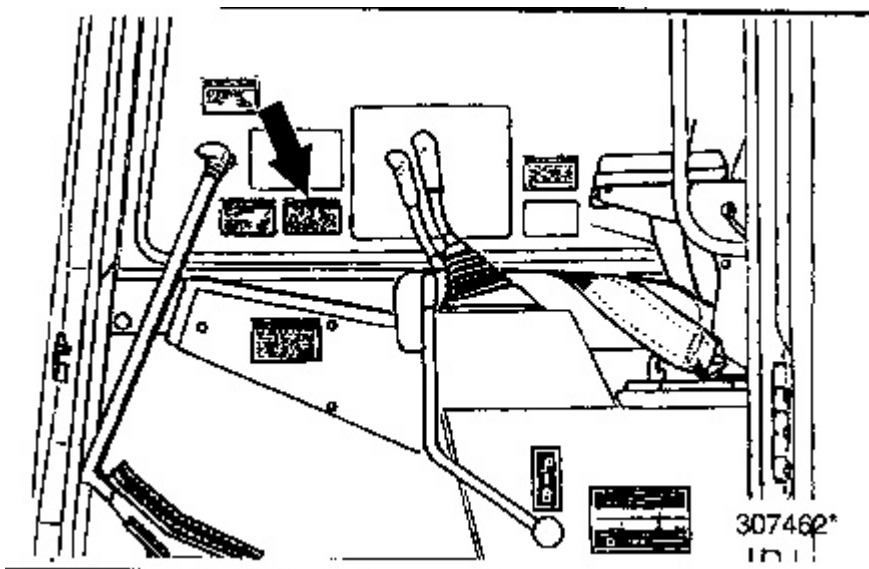

Located in the cab.

 **WARNING**

**Improper jumper cable connections can cause an explosion resulting in personal injury. When using jumper cables always connect positive (+) cable to positive (+) terminal of battery connected to starter solenoid and negative (-) cable from external source to starter negative (-) terminal. (If not equipped with starter negative terminal, connect to engine block.)**

---



Located on the back of the battery compartment cover.

**! WARNING**

#### **HYDRAULIC TANK**

**Relieve tank pressure with engine off by removing cap slowly to prevent burns from hot oil.**

---

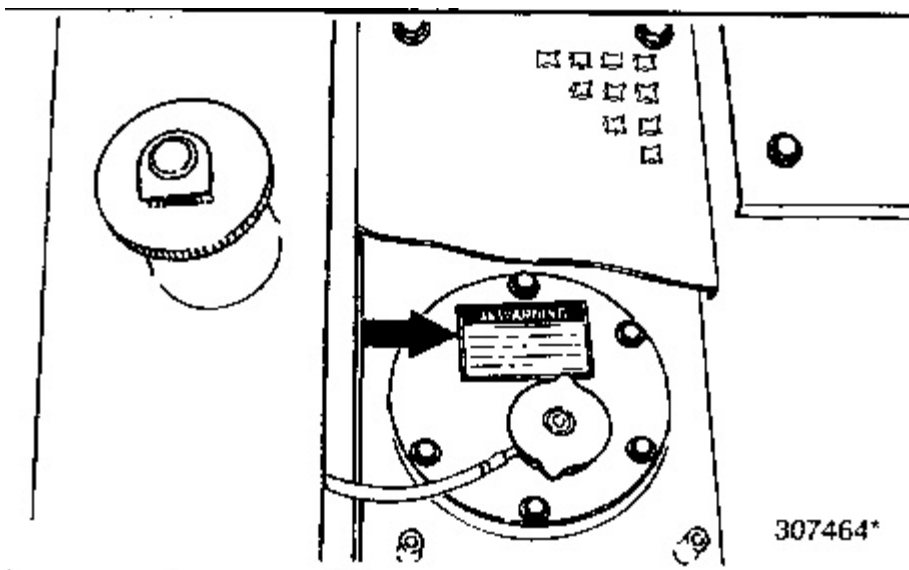

Located on the hydraulic tank.

**! WARNING**

**Lift eyes or tank can fail when lifting tank containing fluids resulting in possible personal injury. Drain tank of all fluids before lifting.**

---

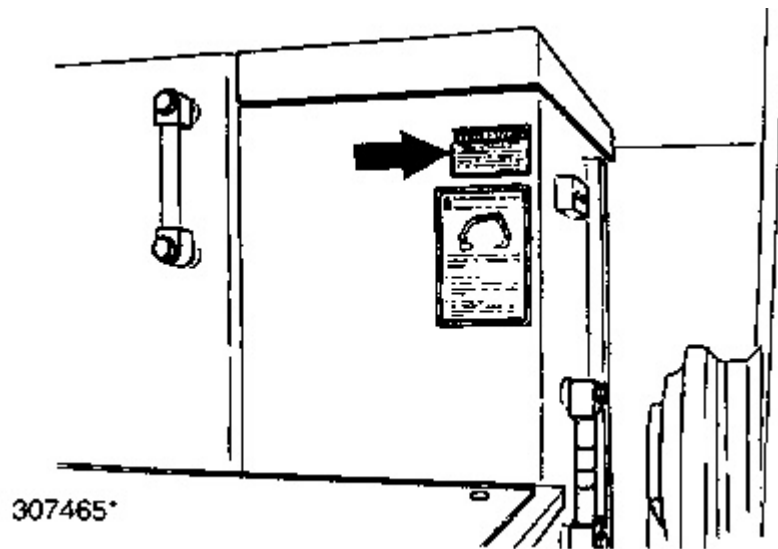

Located on the hydraulic tank and the fuel tank.

## **WARNING**

### **HIGH PRESSURE CYLINDER**

**Do not remove or disassemble any hydraulic components or parts until pressure has been relieved or personal injury may occur.**

**To relieve pressure:**

- 1. Shut off engine.**
- 2. With operator in seat and bucket on ground, engage neutralizing lever and actuate an implement control lever about ten times to dissipate pressure in hydraulic system.**

	<b>CHARGING MEDIUM</b>	<b>NITROGEN</b>
<b>Precharge Pressure</b>	<b>18 kg/cm<sup>2</sup></b>	<b>1765 kPa (255 psi)</b>
<b>Service Pressure</b>	<b>35 kg/cm<sup>2</sup></b>	<b>3430 kPa (495 psi)</b>
<b>Minimum Bursting Pressure</b>	<b>105 kg/cm<sup>2</sup></b>	<b>10295 kPa (1495 psi)</b>

See your Caterpillar dealer for tools and detailed information.

---

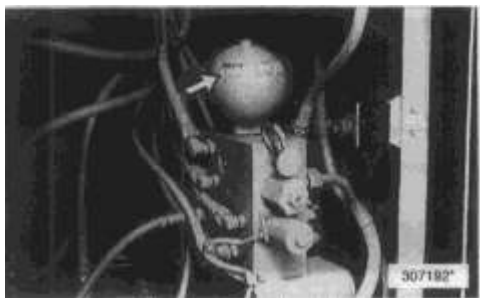

Located on the accumulator.



**WARNING**

### **HIGH PRESSURE CYLINDER**

**Do not remove any parts until all pressure has been relieved to avoid possible personal injury. Relieve pressure by opening fill valve 1 turn maximum.**

---

See the Maintenance Section of this manual for track adjustment procedure.

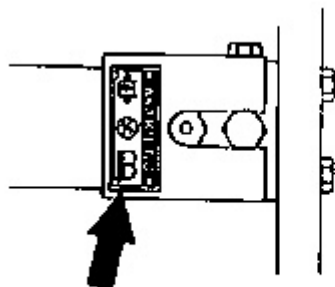

307191\*

Located on both track frames.



**WARNING**

**The boom can interfere with the dozer blade. Know the boom movement extremes and keep boom away from the dozer blade at all times to avoid possible personal injury.**

---

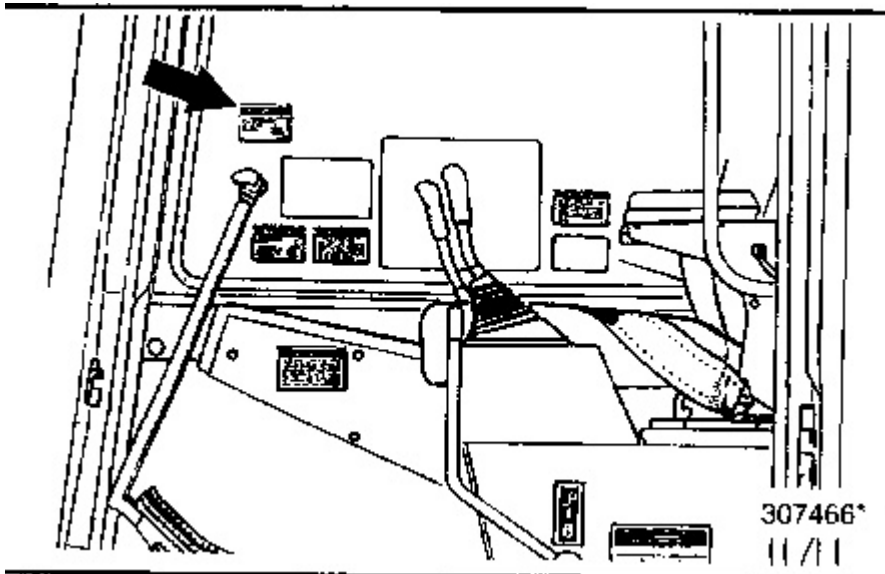

Located in the cab if equipped with a blade.

**! WARNING**

**Put travel control switch in low position before descending a slope and loading or unloading on trailer. Machine control may be adversely affected. Personal injury can result from sudden change in machine control.**

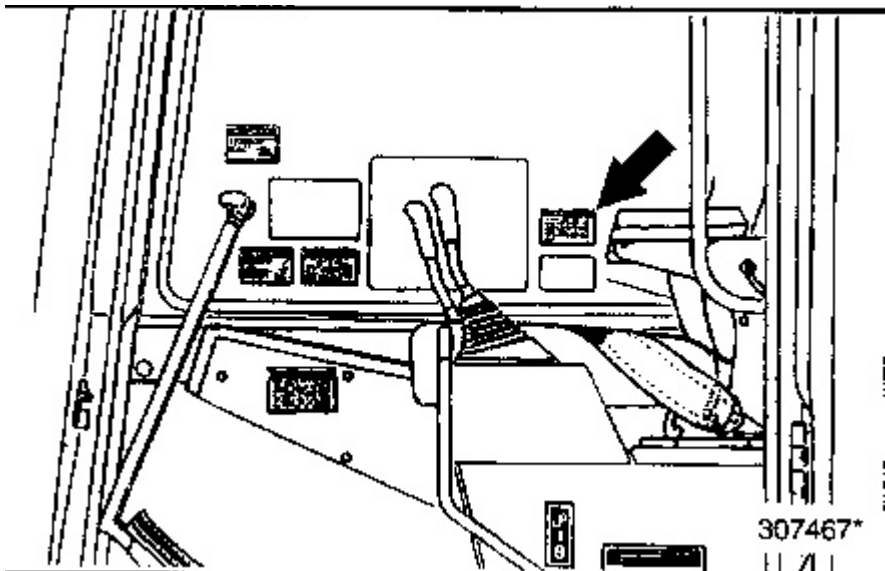

Located in the cab if equipped with two-speed travel motor.

**! WARNING**

The bucket can interfere with the cab on machines equipped with a reverse bucket.

Know the machine's linkage movement extremes. Keep bucket and other attachment tools away from cab at all times to avoid personal injury.

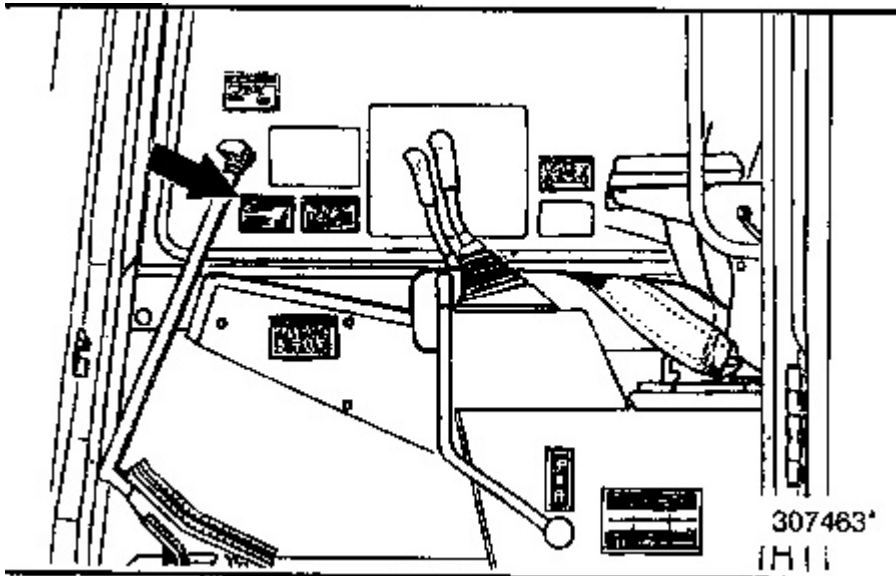

Located in the cab.

### **General Hazard Information**

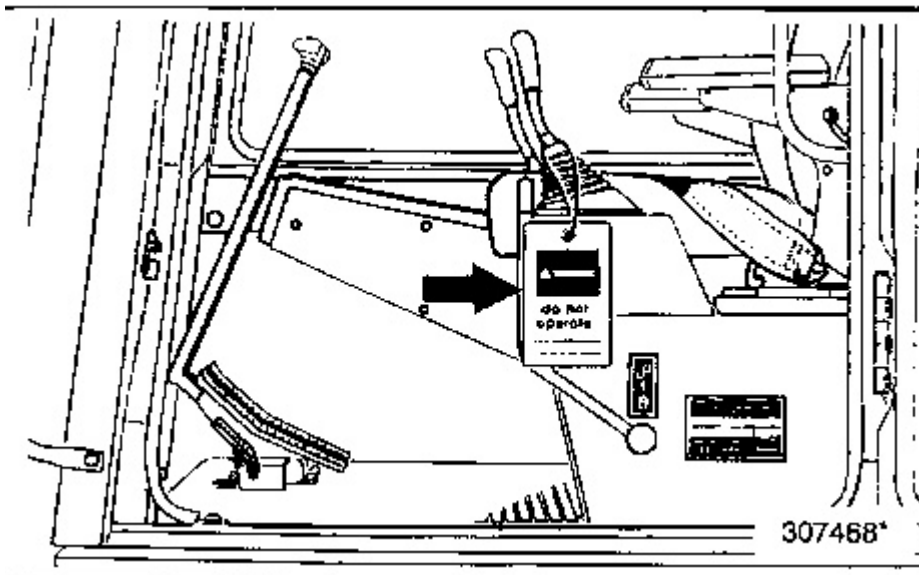

Attach a DO NOT OPERATE, SEHS7332, or similar warning tag to start switch or controls before servicing or repairing the machine. This tag is available from your Caterpillar dealer.

Know the width of your implements so proper clearance can be maintained when operating near fences, boundary obstacles, etc.

Wear a hard hat, protective glasses and other protective equipment as required by job conditions.

Do not wear loose clothing or jewelry that can catch on controls or other parts of the machine.

Make certain all protective guards and covers are secured in place on the machine.

Keep the machine, especially the deck, walkways and steps, free of foreign material, such as debris, oil, tools and other items which are not part of the machine.

Secure all loose items such as lunch boxes, tools and other items which are not part of the machine.

Know the appropriate work-site hand signals and who gives them. Accept signals from one person only.

Inhaling air conditioner refrigerant gas through a lit cigarette or other smoking method or inhaling fumes released from a flame contacting air conditioner refrigerant gas can cause bodily harm or death. Do not smoke when servicing air conditioners or whenever refrigerant gas may be present.

Never put maintenance fluids into glass containers.

Use all cleaning solutions with care.

Report all needed repairs.

Do not allow unauthorized personnel on the machine.

Do not service the engine from the counterweight side. Use a stand alone platform to access the radiator cap, the fuel filter, and the fuel priming pump. Failure to do so could lead to injury or death.

### **Perform all maintenance unless otherwise specified as follows:**

- \* Park the machine on level ground.
- \* Lower the implements to the ground.
- \* Move the implement control levers to the HOLD position.
- \* Move the hydraulic activation control lever to the LOCKED position.
- \* Stop the engine.
- \* Turn the engine start switch off and remove the key.
- \* Turn the disconnect switch off and remove the key.

### **Falling Objects Guard**

This is an attachment guard located above the operator's compartment and secured to the machine.

To avoid possible weakening of the Falling Objects Guard, consult a Caterpillar dealer before altering the Falling Objects Guard in any way. The protection offered by this Falling Objects Guard will be impaired if it has been subjected to structural damage. Structural damage can be caused by an overturn accident, by falling objects, etc.

### **Pressure Air**

Pressure air can cause personal injury. When using pressure air for cleaning, wear a protective face shield, protective clothing and protective shoes.

Maximum air pressure for cleaning purposes must be below 205 kPa (30 psi).

### **Fluid Penetration**

Pressure can be maintained in the hydraulic circuit long after the engine has been stopped. The pressure can cause hydraulic fluid or items such as pipe plugs to shoot out at high speed if pressure is not relieved correctly.

Do not remove or disassemble any hydraulic components or parts until pressure has been relieved or personal injury may occur. To relieve pressure:

1. Stop the engine.
2. With the operator in the seat and the bucket or attachment on the ground, move the hydraulic activation control lever to the unlocked position and actuate an implement control lever about ten times to dissipate pressure in the hydraulic circuit.

Always use a board or cardboard when checking for a leak. Escaping fluid under pressure, even a pin-hole size leak, can penetrate body tissue, causing serious injury, and possible death. If fluid is injected into your skin, it must be treated by a doctor, familiar with this type of injury, immediately.

Track adjusting grease is under high pressure. Grease coming out of the relief valve under pressure can penetrate the body causing injury or death.

Do not watch the relief valve to see if grease is escaping. Watch the track or track adjustment cylinder to see if the track is being loosened. Loosen the relief valve one turn only.

### **Asbestos Information**

This Caterpillar machine and replacement parts shipped from the factory are asbestos free. Caterpillar recommends the use of only genuine Caterpillar replacement parts. If any replacement parts containing asbestos are used, the following guidelines should be used in handling these parts and asbestos debris.

Caution should be used to avoid breathing dust that might be generated when handling components containing asbestos fibers. If this dust is inhaled, it can be hazardous to your health. Components in Caterpillar products that might contain asbestos fibers are brake pads, brake band and lining assemblies, clutch plates and some gaskets. The asbestos used in these components is usually bound in a resin or sealed in some way. Normal handling is not hazardous as long as airborne dust which contains asbestos is not generated.

If dust which can contain asbestos is present, there are several common sense guidelines that should be followed.

- \* Never use compressed air for cleaning.
- \* Avoid brushing or grinding of asbestos containing materials.
- \* For clean up, use wet methods or a vacuum equipped with a high efficiency particulate air (HEPA) filter.
- \* Use exhaust ventilation on permanent machining jobs.

- \* Wear an approved respirator if there is no other way to control the dust.
- \* Comply with applicable rules and regulations for the work place (for example in the U.S.A., OSHA requirements as set forth in 29 CFR 1910.1001).
- \* Follow environmental rules and regulations for disposal of asbestos.
- \* Avoid areas where asbestos particles might be in the air.

## **Crushing or Cutting Prevention**

Support equipment and implements properly when working beneath them. Do not depend on hydraulic cylinders to hold them up. An implement may fall if a control is moved, or if a hydraulic line breaks.

Never attempt adjustments while the machine is moving or the engine is running unless otherwise specified.

Where there are implement linkages, the clearance in the linkage area will increase or decrease with movement of the implement.

Stay clear of all rotating and moving parts.

Keep objects away from moving fan blades. They will throw or cut any object or tool that falls or is pushed into them.

Do not use a kinked or frayed wire rope cable. Wear gloves when handling a wire rope cable.

Retainer pins, when struck with force, can fly out and injure nearby persons. Make sure the area is clear of people when driving retainer pins.

Wear protective glasses when striking a retainer pin to avoid injury to your eyes.

Chips or other debris can fly off objects when struck. Make sure no one can be injured by flying debris before striking any object.

Do not attempt to lift the machine with the lift eyes on the cab or counterweight. Refer to the lifting instructions included in the Transportation Information portion of the Operation Section, or consult your Caterpillar dealer for lifting instructions.

## **Burn Prevention**

### **Coolant**

At operating temperature, the engine coolant is hot and under pressure. The radiator and all lines to heaters or the engine contain hot coolant or steam. Any contact can cause severe burns.

Steam can cause personal injury.

Check the coolant level only after the engine has been stopped and the fill cap is cool enough to remove with your bare hand.

Remove the cooling system fill cap slowly to relieve pressure.

Cooling system additive contains alkali that can cause personal injury. Avoid contact with the skin, eyes and mouth.

Allow cooling system components to cool before draining.

## **Oils**

Hot oil and components can cause personal injury. Do not allow hot oil or components to contact the skin.

At operating temperature, the hydraulic oil tank is hot and can be under pressure.

To relieve the pressure from the hydraulic tank, remove the hydraulic fill/vent cap at the top of the tank.

Remove the hydraulic tank fill/vent cap only after the engine has been stopped and the fill/vent cap is cool enough to remove with your bare hand.

Remove the hydraulic tank fill/vent cap slowly to relieve pressure.

Relieve all pressure in air, oil, fuel or cooling systems before any lines, fittings or related items are disconnected or removed.

## **Batteries**

Batteries vent flammable fumes which can explode.

Do not smoke when observing the battery electrolyte levels.

Electrolyte is an acid and can cause personal injury if it contacts skin or eyes.

Always wear protective glasses when working with batteries.

## **Fire or Explosion Prevention**

All fuels, most lubricants and some coolant mixtures are flammable.

Fuel leaked or spilled onto hot surfaces or electrical components can cause a fire.

Do not smoke while refueling or in a refueling area.

Do not smoke in areas where batteries are charged, or where flammable materials are stored.

Batteries can be located in separate compartments. When using jump start cables, always connect positive (+) cable to positive (+) terminal of battery connected to starter solenoid and connect negative (-) cable from external source to starter negative (-) terminal. (If not equipped with starter negative (-) terminal, connect to engine block.)

Refer to the Operation Section of this manual for specific starting instructions.

Do not use other types of starting aids such as ether on engines equipped with inlet manifold heaters. Such use could result in an explosion and personal injury.

Clean and tighten all electrical connections. Check daily for loose or frayed electrical wires. Have all loose or frayed electrical wires tightened, repaired or replaced before operating the machine.

Keep all fuels and lubricants stored in properly marked containers and away from all unauthorized persons.

Store all oily rags or other flammable material in a protective container.

Do not weld or flame cut on pipes, tubes or tanks that contain flammable fluids. Clean them thoroughly with nonflammable solvent before welding or flame cutting on them.

Remove all flammable materials such as fuel, oil and other debris before they accumulate on the machine.

Do not expose the machine to flames, burning brush, etc., if at all possible.

Shields, which protect hot exhaust components from oil or fuel spray in the event of a line, tube or seal failure, must be installed correctly.

### **Fire Extinguisher**

Have a fire extinguisher available and know how to use it. Inspect and have it serviced as recommended on its instruction plate.

### **Lines, Tubes and Hoses**

Do not bend or strike high pressure lines. Do not install bent or damaged lines, tubes or hoses.

Repair any loose or damaged fuel and oil lines, tubes and hoses. Leaks can cause fires. Contact your Caterpillar dealer for repair or replacement.

Check lines, tubes and hoses carefully. Do not use your bare hand to check for leaks. Use a board or cardboard to check for leaks. Refer to Fluid Penetration in the Safety Section of this manual for more details. Tighten all connections to the recommended torque.

Replace lines, tubes or hoses if any of the following conditions are found:

- \* End fittings damaged or leaking.
- \* Outer covering chafed or cut and wire reinforcing exposed.
- \* Outer covering ballooning locally.
- \* Evidence of kinking or crushing of the flexible part of hose.
- \* Armoring embedded in the outer cover.
- \* End fittings displaced.

Make sure that all clamps, guards and heat shields are installed correctly to prevent vibration, rubbing against other parts, and excessive heat during operation.

### **Mounting and Dismounting**

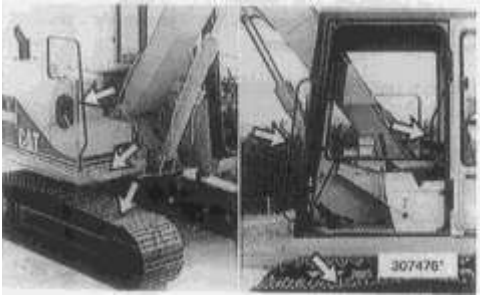

- \* Mount and dismount the machine only where steps and/or handholds are provided.
- \* Inspect, and when necessary, clean and have repairs made to steps and handholds before mounting and dismounting.

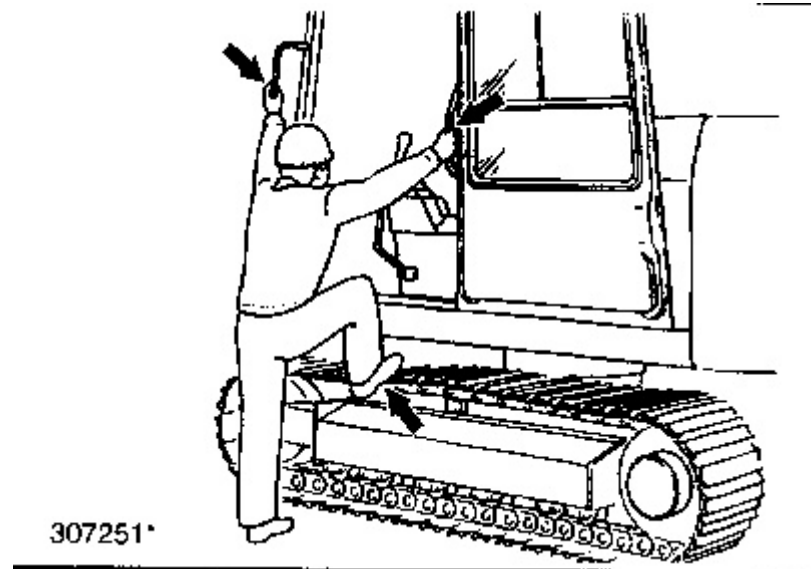

- \* Face the machine when mounting and dismounting.
- \* Maintain a three point contact (two feet and one hand or one foot and two hands contact) with the handholds and track as a step.
- \* Never get on or off a moving machine.
- \* Never jump off the machine.
- \* Do not try to climb on or off the machine when carrying tools or supplies. Use a hand line to pull equipment up onto the platform.
- \* Do not use any controls as handholds when entering or leaving the operator's station.

### **Alternate Exit**

Machines equipped with cabs are equipped with alternate exits. For additional alternate exit information, refer to Rear Window in the Monitoring Systems and Cab Features portion of this manual.

### **Before Starting the Engine**

Start the engine only from the operator's station. Never short across the starter terminals or across the batteries, as this could bypass the engine neutral-start system as well as damage the electrical system.

Inspect the condition of the seat belt and mounting hardware. Replace any damaged or worn parts. Replace the seat belt, regardless of appearance, after three years of use. Do not use a seat belt extension on a retractable seat belt.

Adjust the seat so that full pedal travel can be obtained with the operator's back against the seat back.

Make sure the machine is equipped with a lighting system as required by conditions.

Make sure all lights are working properly.

Make sure no one is working on, underneath or close to the machine before starting the engine or beginning to move the machine. Make sure the area is free of personnel.

## **Engine Starting**

Do not start the engine or move any of the controls if there is a DO NOT OPERATE or similar warning tag attached to the engine start switch or controls.

Move all hydraulic controls to the HOLD position before starting the engine.

Move the hydraulic activation control lever to the LOCKED position.

Diesel engine exhaust contains products of combustion which may be harmful to your health. Always start and operate the engine in a well ventilated area. If in an enclosed area, vent the exhaust to the outside.

## **Before Operating the Machine**

Clear all personnel from the machine and the area.

Clear all obstacles from the path of the machine. Beware of hazards such as wires, ditches, etc.

Be sure all windows are clean. Secure the doors and windows in either the open or shut position.

Adjust the rear view mirrors (if equipped) for best vision, especially close to the machine.

Make sure the machine horn, the travel alarm (if equipped) and all other warning devices are working properly.

Before moving the machine, check the position of the undercarriage. The normal travel position is with the idler wheels to the front under the cab and the drive sprockets to the rear. When the undercarriage is in the opposite position, the directional controls must be operated in opposite directions.

Fasten the seat belt securely.

Warm up the engine and the hydraulic oil before operating the machine.

## **Machine Operation**

Operate the machine only while seated and with the seat belt fastened.

Operate the controls only with the engine running to prevent uncontrolled movement of implements.

Check for proper operation of all controls and protective devices while moving slowly in an open area.

Watch boom clearances when moving the machine. Uneven ground can cause the boom to move from side to side or up and down.

The operator must be satisfied that no one will be endangered before moving the machine.

Do not allow riders on the machine unless additional seat and seat belt are provided.

Report any needed repairs noted during operation.

Carry implements close to the ground, approximately 40 cm (15 in) above ground level.

Stay an adequate distance from the edge of cliffs, overhangs and slide areas.

If the machine begins to sideslip on a grade, immediately dispose of the load and turn the machine downhill.

Be careful to avoid conditions which could lead to tipping when working on hills, banks or slopes, and when crossing ditches, ridges or other obstructions.

Work up and down slopes, rather than sideways, whenever possible.

Keep the machine under control and do not work it over its capacity.

Avoid changing the direction of travel on a slope, which could result in tipping or side slipping of the machine.

Bring the load close to the machine before traveling or swinging the load.

Lifting capacity decreases as the load is moved further from the machine.

Be sure hitch points and the towing device are adequate.

Connect trailing equipment to a drawbar or hitch only.

Never straddle a wire rope cable or similar device, nor allow others to do so.

No personnel should be between the machine and trailing equipment when maneuvering to connect them. Block the tongue or hitch of trailing equipment to align it with the drawbar or hitch.

Local or state codes, and/or job site operating directives may require a specific minimum distance from obstacles.

Check with the local utilities for the locations of buried pipes and cables before operating the machine.

Know the maximum height and reach of your machine.

Keep eye contact with the load at all times.

Always keep the Falling Objects Guard (if equipped) installed when operating the machine.

The clamshell can swing in all directions. Use hydraulic controls smoothly to avoid excessive clamshell swing. Failure to do so could cause the clamshell to swing into the cab or into a person in the work area, resulting in personal injury.

### **Lifting Objects With Bucket**

There may be some local government regulations regarding the use of excavators to lift heavy objects. Please observe those regulations where they apply.

### **Machine Parking**

The hydraulic implement and machine controls are "live" for as long as the accumulator holds a charge, even if the engine is not running. This pressure charge should bleed off in a short time (approximately one minute.)

Sudden and unexpected machine and/or implement movement will occur if any of the controls are moved. This can cause personal injury or death.

Always move the hydraulic and directional lock lever to the LOCKED position before shutting off the engine or immediately after the engine quits running.

Park on a level surface. If necessary to park on a grade, block the machine.



Servicing position.

Place the attachments in the servicing position.

Move the hydraulic activation control lever to the LOCKED position.

Turn the engine start switch to the OFF position and remove the key.

Turn the battery disconnect switch key to OFF and remove the key when leaving the machine for an extended period of a month or longer. This will prevent battery drain by short circuits or current draw made by some of the components, or by vandalism. Also, remove the key when servicing the electrical system.

---

Product: EXCAVATOR

Model: 307-A EXCAVATOR 2PM

Configuration: 307 TRACK-TYPE EXCAVATOR 2PM00001-UP (MACHINE) POWERED BY 4D32 ENGINE

## Operation and Maintenance Manual 307 EXCAVATORS

Media Number -SEBU6835-02

Publication Date -01/10/1999

Date Updated -30/01/2002

## Specifications and Model View

SMCS - 7606

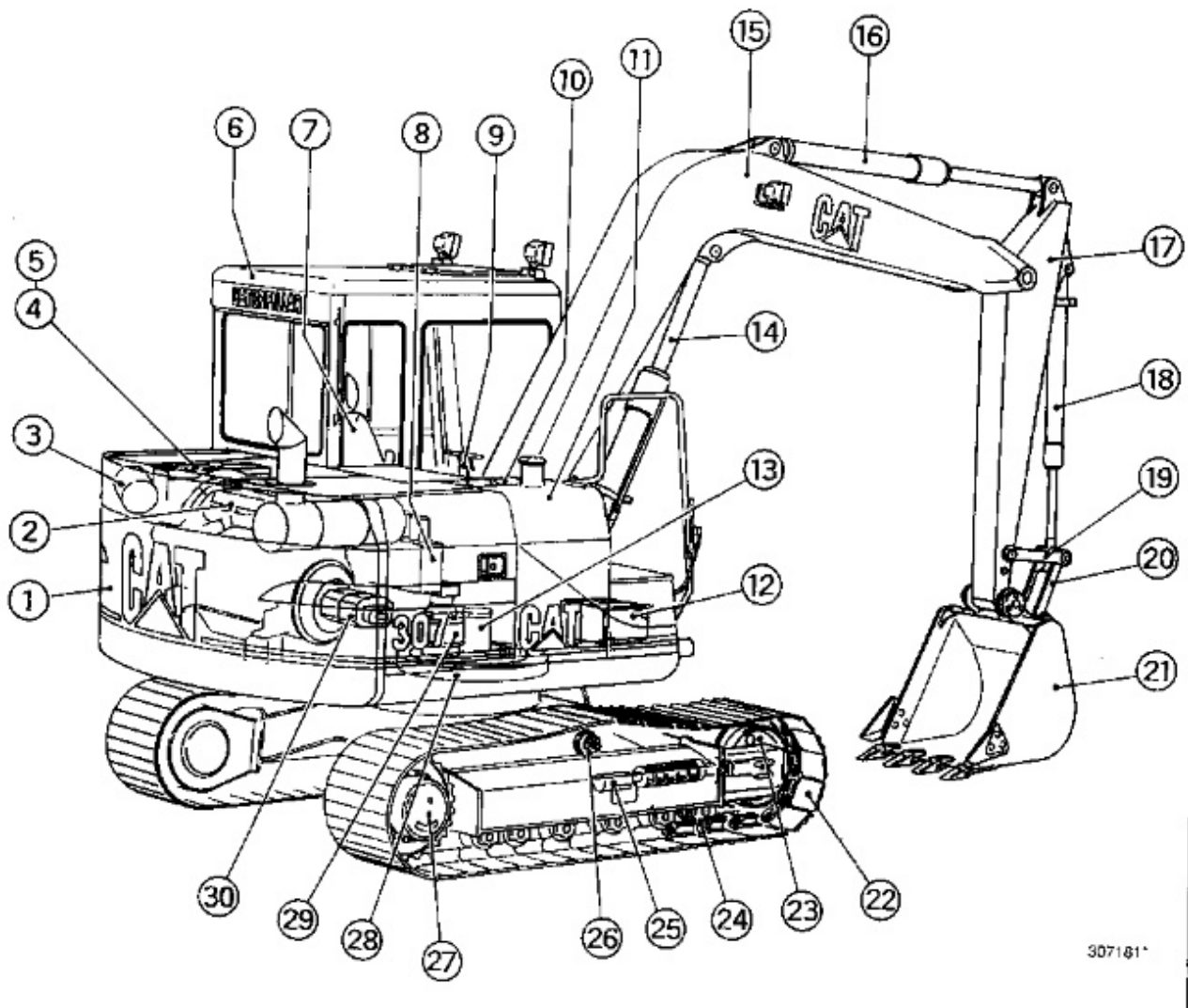

307181\*

Standard Machine (Equipped With One Piece Boom)

(1) Counterweight. (2) Engine. (3) Air Cleaner. (4) Radiator and Oil Cooler. (5) Engine Hood. (6) Cab. (7) Operator's Seat. (8) Main Control valves. (9) Implement Control Lever. (10) Hydraulic Tank. (11) Fuel Tank. (12) Battery. (13) Swivel. (14) Boom Cylinder. (15) Boom (16) Stick Cylinder. (17) Stick. (18) Bucket Cylinder. (19) Link (20) Power



**Suggest:**

**For more complete manuals. Please go to the home page.**

**<https://www.ebooklibonline.com>**

**If the above button click is invalid. Please download this document first, and then click the above link to download the complete manual.**

**Thank you so much for reading**

Link. (21) Bucket. (22) Track. (23) Idler. (24) Track Roller. (25) Track Adjuster. (26) Carrier Roller. (27) Final Drive (with motor). (28) Swing Bearing (with motor). (29) Swing Drive. (30) Pump.

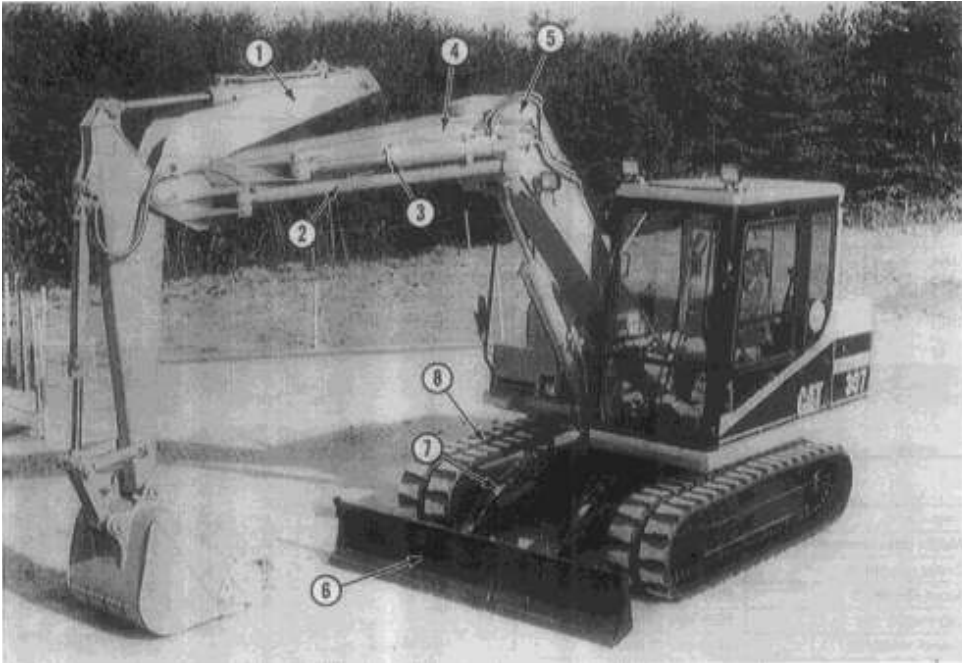

Machine (Equipped With Hydraulic Offset Boom, Blade and Rubber Belt Track)

(1) Cylinder Stay. (2) Offset Bar. (3) Offset Cylinder. (4) Upper Boom. (5) Lower Boom. (6) Blade. (7) Blade Cylinder. (8) Rubber Belt Track.

**NOTE:** See the standard machine view for components other than indicated above.

Basic machine shipping specifications are listed in the following chart.

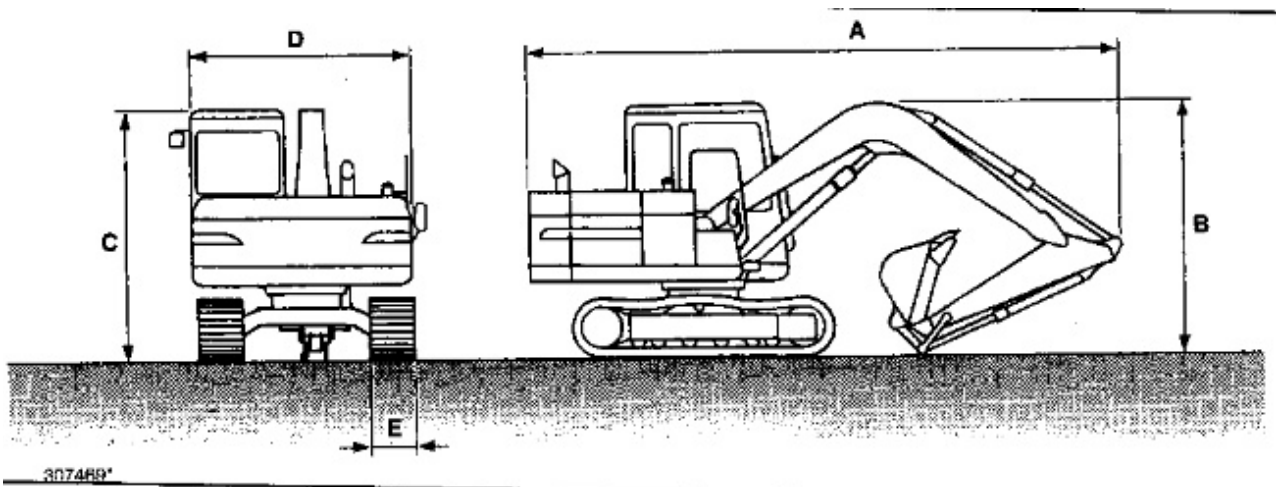

<b>307 Excavator <sup>1</sup></b>	
Weight (approximate)	6650 kg (14630 lb)
Overall Length :A	6080 mm (19 ft 11 in)
Boom Height :B	2610 mm (8 ft 7 in)
Cab Height :C	2590 mm (8 ft 6 in)
Overall Width :D	2230 mm (7 ft 4 in)
Track Shoe Width :E	450 mm (1 ft 6 in)

<sup>1</sup> If equipped with one piece boom, 1.72 m (5 ft 8 in) stick and 0.28 m<sup>3</sup> bucket with full fuel.

**NOTE:** For information on specifications for configurations other than those included in the above chart, consult your Caterpillar dealer.

### Compatibility Chart For Boom/Stick/Bucket Combinations

This machine can be equipped with a large variety of front implement combinations to meet the needs of various applications.

As a general rule, to assure better machine stability and protect against structural machine damage, use a smaller capacity bucket when used with a longer stick and a larger one when used with a shorter stick.

The following chart represents various compatible combinations of the stick and bucket. Select an optimum combination depending on type of work conditions and purposes.

Application	Bucket Capacity (SAE)	Bucket Width	R-Boom (1 Piece Boom)		Off Set Boom
			Stick		
			R 2.21 (7 ft 3 in)	R 1.72 (5 ft 8 in)	
X	0.18 m <sup>3</sup>	500 mm (1 ft 8 in)	○	○	○
	0.23 m <sup>3</sup>	600 mm (2ft)	⊖	○	○
	0.24 m <sup>3</sup>	700 mm (2 ft 4 in)	○	○	○
	0.28 m <sup>3</sup>	800 mm (2 ft 7 in)	○	⊖	⊖

⊖ - Preferred

○ - Permissible

Notes:

1. Description of Abbreviations

A. R - Boom = REACH Boom

B. R1.72 STICK, as a typical example, is a designation of a 1.72 m stick that Caterpillar recommends to be used with a reach boom and 800 mm width bucket.

C. X - Excavation

**<https://www.ebooklibonline.com>**

Hello dear friend!

Thank you very much for reading.

Enter the link into your browser.

The full manual is available for immediate download.

**<https://www.ebooklibonline.com>**