

Product: TRACK-TYPE TRACTOR

Model: D4E TRACK-TYPE TRACTOR 31C

Configuration: D4E TRACTORS / POWER SHIFT / 31C00100-UP (MACHINE) POWERED BY 3304 ENGINE

Disassembly and Assembly 3304 & 3306 VEHICULAR ENGINE

Media Number -SEN2824-00

Publication Date -01/01/1983

Date Updated -11/10/2001

Turbocharger (3306)

SMCS - 1052-16; 1052-11; 1052-12; 1052-15

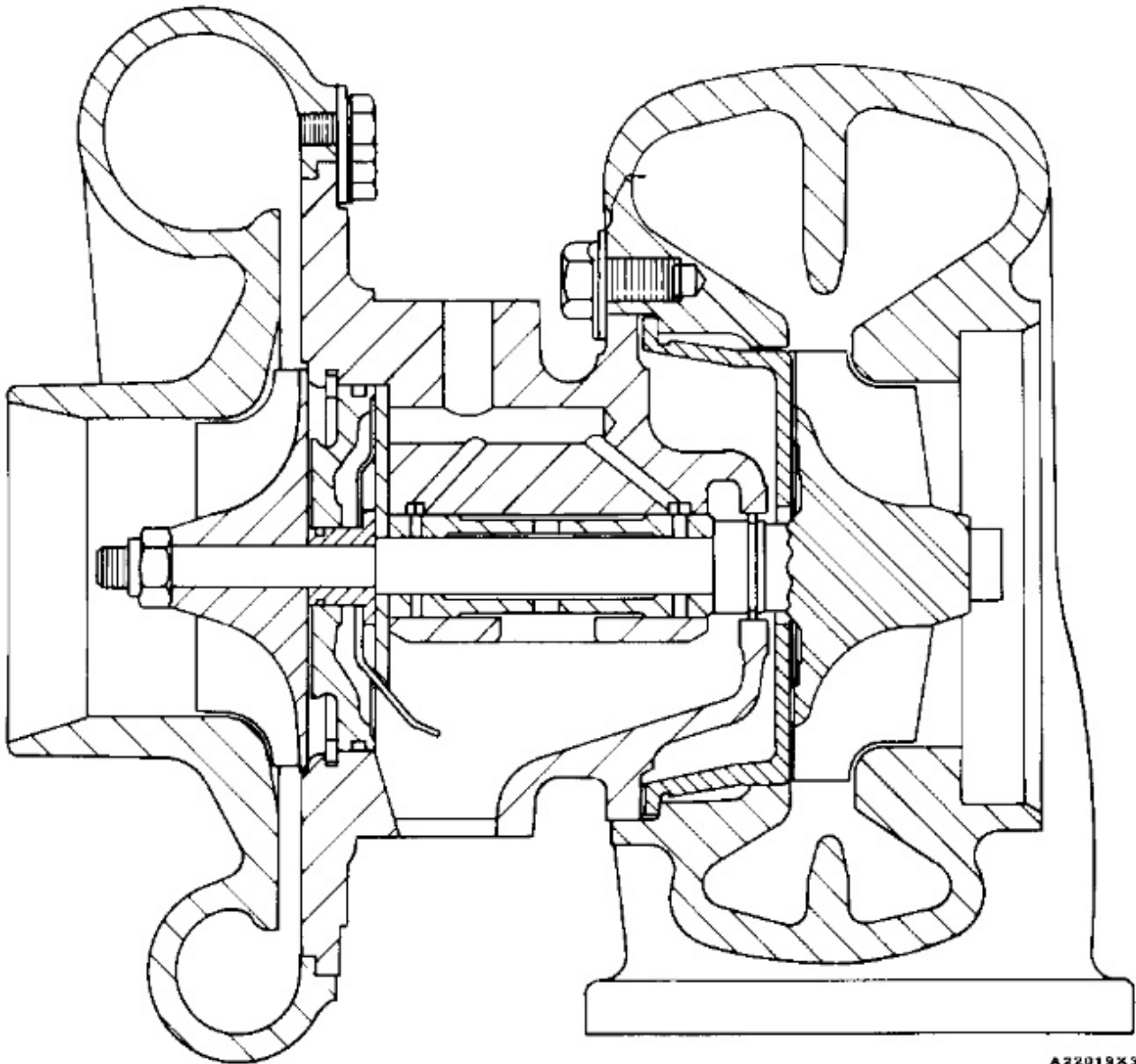

A22019X3

Remove Turbocharger

start by:

a) remove hood, muffler and precleaner assembly

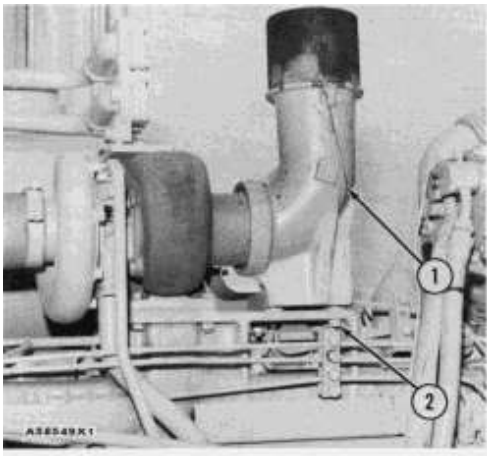

1. Remove three bolts and nuts (2) that hold elbow (1) to the exhaust manifold. Remove the elbow. Remove the seal ring from the groove in the coupling on the turbocharger. Check the condition of the seal. If the seal has damage, use a new part for replacement.

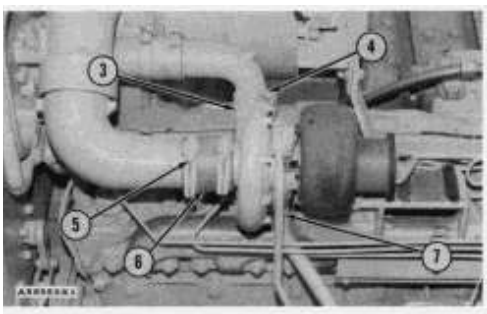

2. Loosen two clamps (4) and slide hose (3) off the turbocharger. Loosen two clamps (5) and slide hose (6) off the turbocharger.

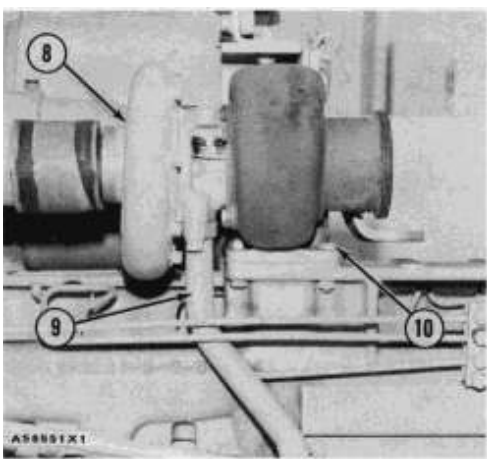

3. Remove oil supply tube (7).

4. Remove oil drain tube assembly (9) from the turbocharger.

5. Remove four bolts (10) and nuts. Remove turbocharger (8) from the exhaust manifold.

Install Turbocharger

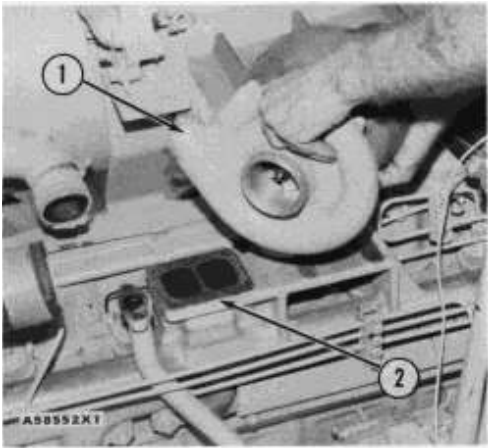

1. Put a new gasket (2) for the turbocharger in position on the exhaust manifold.
2. Put 5P3931 Anti-Seize Compound on the threads of the four bolts that hold the turbocharger to the exhaust manifold.
3. Put turbocharger (1) in position on the exhaust manifold and install the four bolts and nuts that hold it. Tighten the bolts to a torque of $55 \pm 5 \text{ N}\cdot\text{m}$ ($40 \pm 4 \text{ lb. ft.}$).

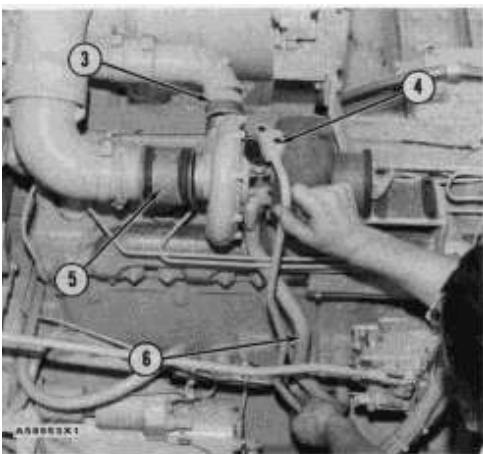

4. Install a new gasket and drain tube assembly (6).
5. Install a new gasket and oil supply tube assembly (4).
6. Slide hose (3) in position on the turbocharger and install the clamps that hold it.
7. Slide hose (5) in position on the turbocharger and install the clamps that hold it.

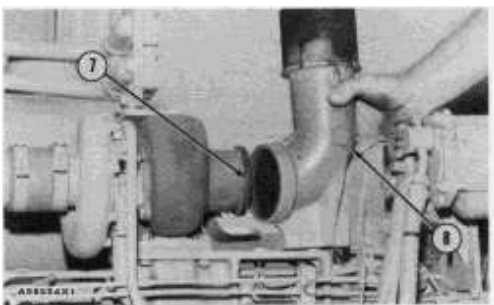

<https://www.ebooklibonline.com>

Hello dear friend!

Thank you very much for reading.

Enter the link into your browser.

The full manual is available for immediate download.

<https://www.ebooklibonline.com>

8. Install a new seal ring (7) in the groove on the coupling.

9. Put 5P3931 Anti-Seize Compound on the threads of the three bolts that hold elbow (8) to the exhaust manifold. Install elbow (8).

end by:

a) install hood, muffler and precleaner assembly

Disassemble Turbocharger

| | Tools Needed | A | B | C | D |
|--------|----------------------------|---|---|---|---|
| 9S6363 | Turbocharger Fixture Group | 1 | | | |
| 9S6343 | Fixture Assembly | | 1 | | |
| 5S9566 | T-Wrench | | | 1 | |
| 1P1861 | Snap Ring Pliers | | | | 1 |

start by:

a) remove turbocharger

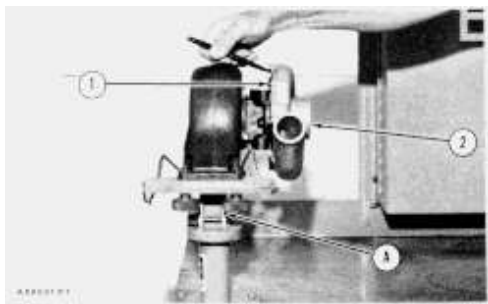

1. Install turbocharger on tool group (A). Put marks on the three housings of the turbocharger for correct installation and alignment at assembly.

2. Remove eight bolts (1) and lockwashers. Remove four plates and compressor housing (2).

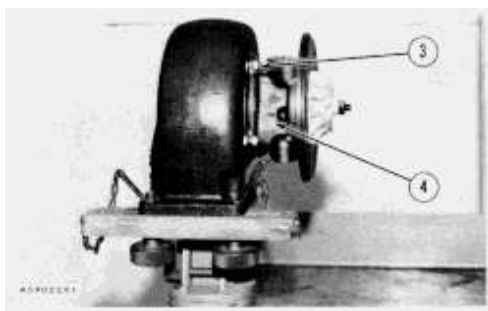

3. Remove two locks, two plates and four bolts (3) that hold the cartridge housing to the turbine housing. Remove cartridge housing (4).

NOTICE

When the nut is loosened, do not put a side force on the shaft.

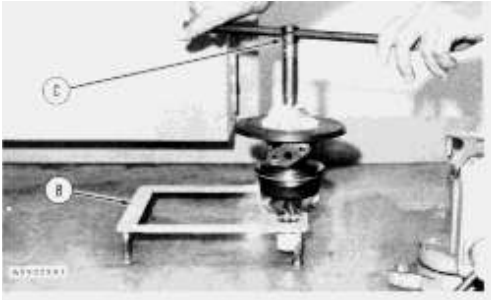

4. Put the cartridge assembly on tool (B) as shown. Use tool (C) and the correct size socket to remove the nut that holds compressor wheel (5) on the shaft.



5. Hold the cartridge assembly down in tool (B) and lift and turn the compressor wheel (5) at the same time to remove it from the shaft.



6. Remove cartridge assembly (6) from the shaft.

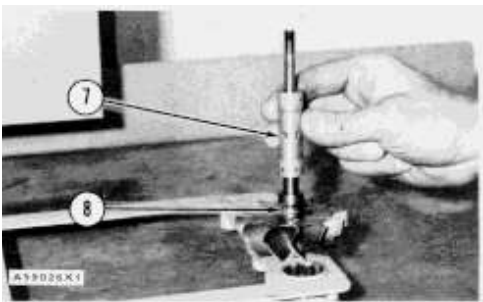

7. Remove bearing (7) and ring (8) from the shaft.



8. Remove ring (9) from the housing assembly with tool (D).



9. Remove the insert, sleeve and deflector from the housing assembly as a unit. Use two screwdrivers to remove the unit.

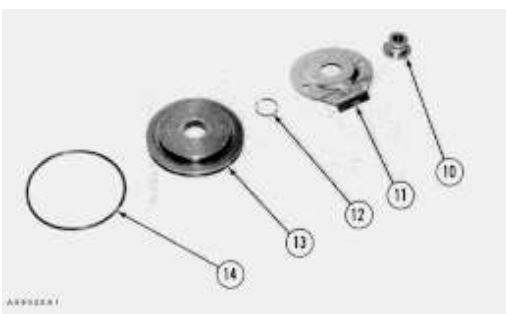

10. Remove O-ring seal (14) from insert (13). Remove sleeve (10) from the insert and deflector (11). Remove ring (12) from the sleeve.



11. Remove bearing (15) from the housing assembly.

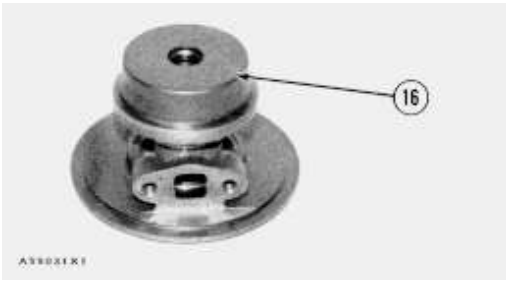

12. Turn the housing assembly over. Remove shroud (16) and the gasket from the housing assembly.

Assemble Turbocharger

| Tools Needed | | A | B | C |
|--------------|----------------------------|---|---|---|
| 9S6343 | Fixture Assembly | 1 | | |
| 1P1861 | Snap Ring Pliers | | 1 | |
| 9S6363 | Turbocharger Fixture Group | | | 1 |

1. Make sure that all of the oil passages in the cartridge housing assembly are clean and free of dirt and foreign material. Put clean oil on all the parts of the cartridge assembly.

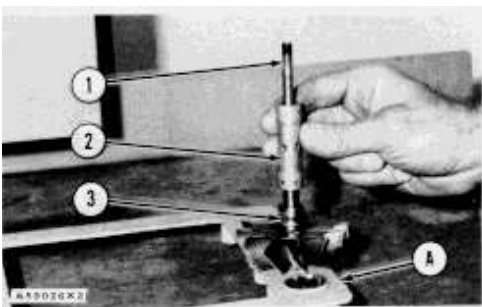

2. Put shaft (1) in position in tool (A). Install ring (3) and bearing (2) in the shaft as shown.

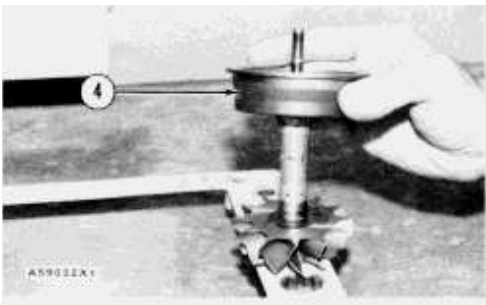

3. Put shroud (4) in position on the shaft as shown.



4. Put gasket (6) in position on the shroud. Install housing assembly (5) over the shaft.

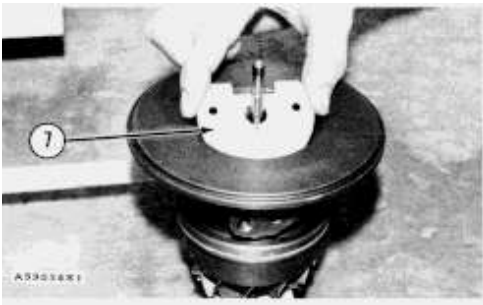

5. Install bearing (7) in the housing assembly. Make sure the bronze side of the bearing is up.

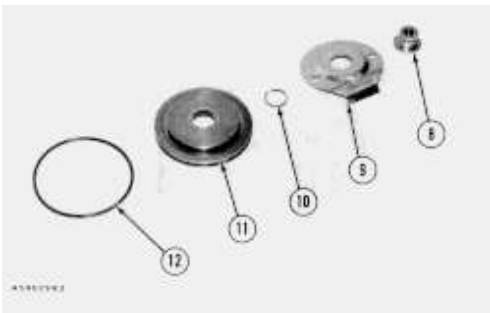

6. Put deflector (9) in position over sleeve (8).

7. Install ring (10) in the groove on the sleeve. Push the sleeve into insert (11). Install O-ring seal (12) on the insert.



8. Install the insert, deflector and sleeve as a unit in the housing assembly as shown.

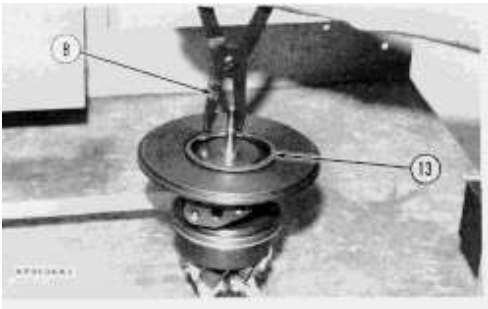

9. Install ring (13) in the groove in the housing assembly with tool (B).



10. Put compressor wheel (14) in position on the shaft.

NOTICE

Do not put a side force on the shaft when the nut that holds the compressor wheel in position is tightened.

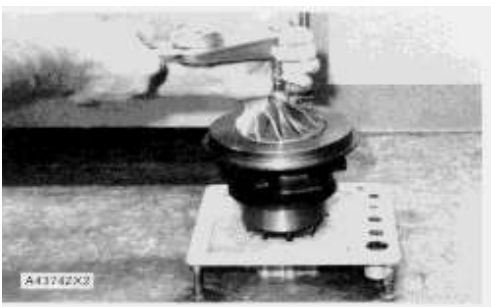

TYPICAL EXAMPLE

11. Install the nut that holds the compressor wheel in position. Tighten the nut to a torque of 18.7 ± 1.7 N·m (165 ± 15 lb. in.).

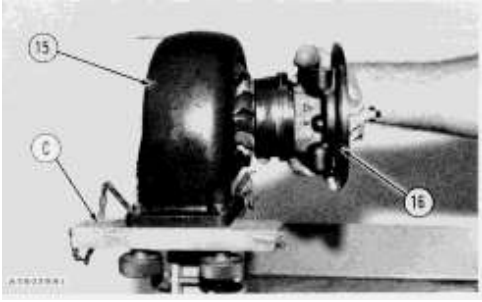

12. Put turbine housing (15) in position on tool (C). Put cartridge assembly (16) in position in the housing. Make sure the mark on the cartridge assembly is in alignment with the mark on the housing. Put 5P3931 Anti-Seize Compound on the threads of the bolts that hold cartridge assembly to the turbine housing. Install the two locks, two plates and four bolts that hold the cartridge assembly to the turbine housing. Tighten the bolts to a torque of 15 to 17 N·m (11 to 12 lb. ft.). Bend the locks over the bolts.

13. Put compressor housing (17) in position on the cartridge assembly. Make sure the mark on the housing is in alignment with mark on the cartridge assembly. Put 5P3931 Anti-Seize Compound on the threads of the bolts that hold the compressor housing to the cartridge assembly. Install the four plates and eight bolts and lockwashers that hold the compressor housing in position. Tighten the eight bolts to a torque of 6.8 N·m (60 lb. in.).

end by:

a) install turbocharger

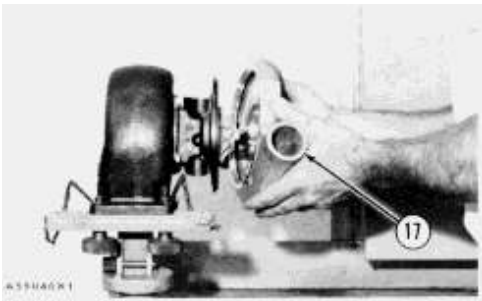

Product: TRACK-TYPE TRACTOR

Model: D4E TRACK-TYPE TRACTOR 31C

Configuration: D4E TRACTORS / POWER SHIFT / 31C00100-UP (MACHINE) POWERED BY 3304 ENGINE

Disassembly and Assembly 3304 & 3306 VEHICULAR ENGINE

Media Number -SEN2824-00

Publication Date -01/01/1983

Date Updated -11/10/2001

Fuel Injection Lines

SMCS - 1152-11; 1152-12

Remove Fuel Injection Lines

NOTE: The hood and guard assembly is removed for better photo illustration of the removal of the fuel injection lines.

1. Turn the valve for the fuel supply to the "OFF" position.
2. Remove all of the clamps and dampers (1) from the fuel lines.
3. Disconnect the fuel injection lines at the fuel injection pump housing. Put protection caps on the lines and pumps to keep dirt and foreign material out of the fuel system.
4. Disconnect the fuel injection lines from the fuel injection valves. Put protection caps on the lines and valves.
5. Remove all of the fuel injection lines (2).

Install Fuel Injection Lines

| Tools Needed | | A |
|--------------|--------|---|
| 5P144 | Socket | 1 |

1. Make sure the fuel injection lines are clean and dry.

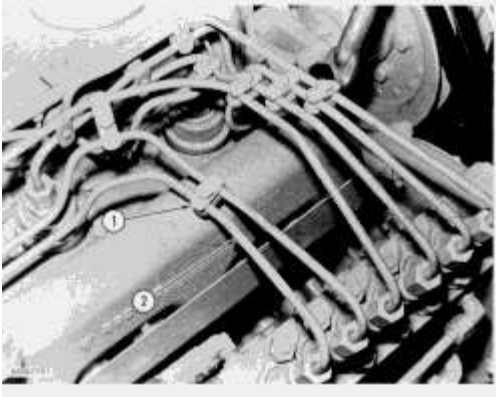

2. Put the fuel injection lines (2) in position and connect them to the fuel injection pumps and valves.
 3. Remove (bleed) the air from the fuel system.
 4. Tighten the nuts on the fuel injection lines with tool (A) to a torque of $40 \pm 7 \text{ N}\cdot\text{m}$ ($30 \pm 5 \text{ lb}\cdot\text{ft}$).
 5. Install dampers and clamps (1). Tighten the bolts that hold the dampers to a torque of $10 \pm 3 \text{ N}\cdot\text{m}$ ($7 \pm 2 \text{ lb}\cdot\text{ft}$).
-

Product: TRACK-TYPE TRACTOR

Model: D4E TRACK-TYPE TRACTOR 31C

Configuration: D4E TRACTORS / POWER SHIFT / 31C00100-UP (MACHINE) POWERED BY 3304 ENGINE

Disassembly and Assembly 3304 & 3306 VEHICULAR ENGINE

Media Number -SEN2824-00

Publication Date -01/01/1983

Date Updated -11/10/2001

Barrel Assembly O-Ring Seals

SMCS - 1152-11; 1152-12

Remove Barrel Assembly O-Ring Seals

| | | |
|--------|-----------------|---|
| | Tools Needed | A |
| 2Y6873 | Alignment Gauge | 1 |

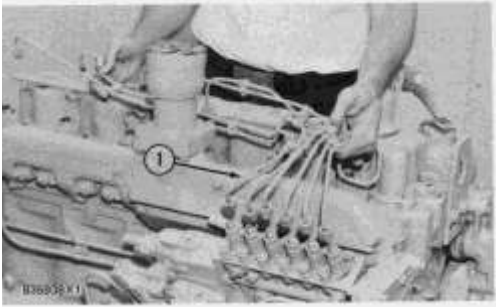

1. Remove fuel injection lines (1) from the engine. Put plugs or caps in the openings.

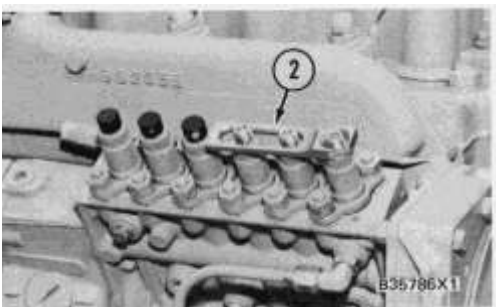

2. Put bar (2) [part of tooling (A)] in position with the hole in the bar on the barrel assembly that is to be removed and the (slot) opening in the bar on the two barrel assemblies next to the one that is to be removed as shown. Install the bar with the chamfer side of the hole up.

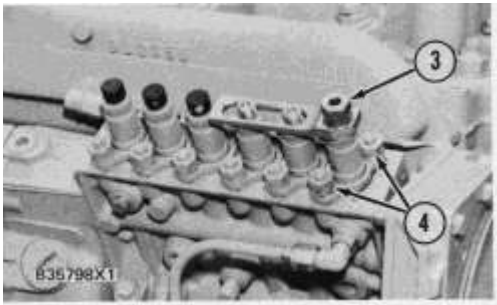

3. Install nut (3) [part of tooling (A)] on the barrel assembly that is to be removed. This will hold the barrel assembly in its original position for installation.

4. Remove nuts (4) and washers that hold the barrel assembly in the fuel injection pump.

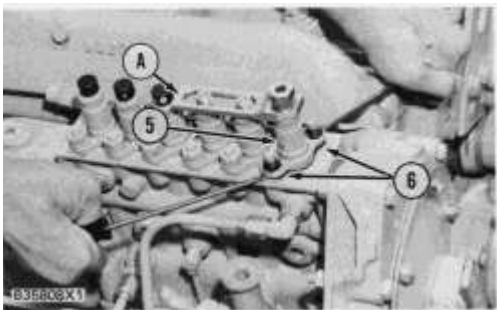

5. Use two screwdrivers and remove barrel assembly (5) from the fuel injection pump.

6. Remove shims (6). Do not mix the shims.

NOTICE

Do not remove tooling (A) from the barrel assembly.

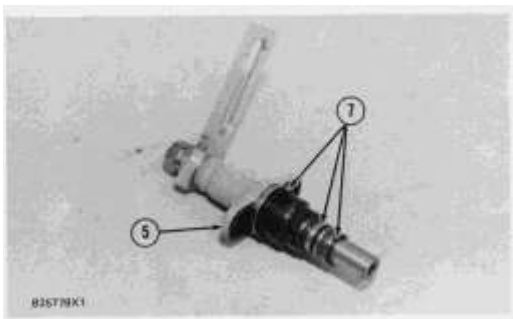

7. Remove O-ring seals (7) from barrel assembly (5).

Install Barrel Assembly O-Ring Seals

| | Tools Needed | A | B |
|--------|-----------------|---|---|
| 2Y6851 | Seal Installer | 1 | |
| 2Y6873 | Alignment Gauge | | 1 |

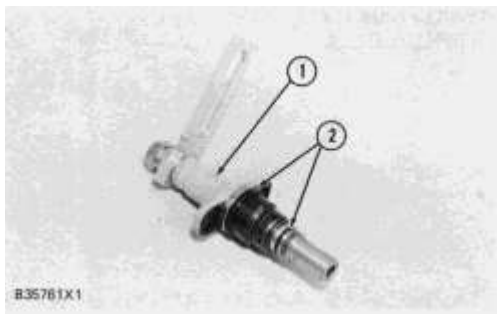

1. Install new O-ring seals (2) on barrel assembly (1).
2. Put 6V2055 Silicone Grease on the outside of the barrel assembly, the barrel housing bore in the fuel injection pump housing and the O-ring seals.



3. Install new O-ring seal (3) in the fuel injection pump housing with tool (A).

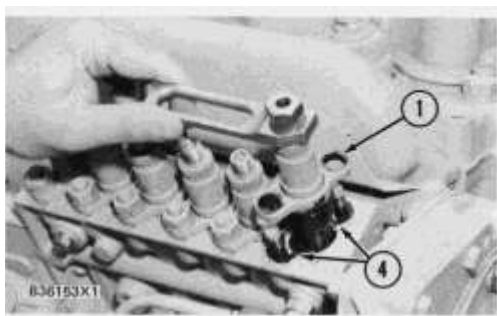

4. Install original shims (4).

NOTICE

If the barrel assembly moves (springs) up when hand pressure is removed, one of the O-ring seals can be damaged. Remove the barrel assembly and install a new O-ring seal.

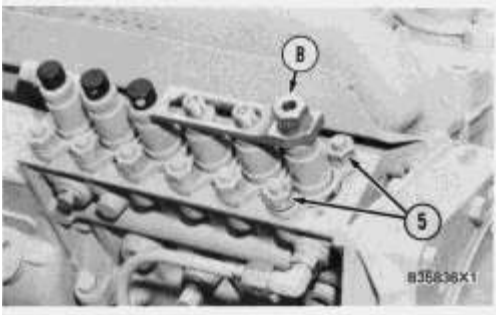

5. Install barrel assembly (1) in the fuel injection pump.

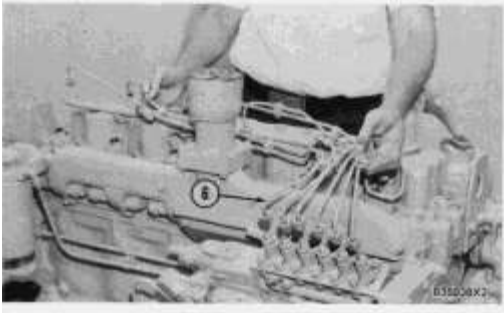

6. Install the washers and nuts (5). Tighten the nuts to a torque of 39 to 44 N·m (28.9 to 32.5 lb. ft.).

7. Remove tooling (B).

8. Install fuel lines (6). Tighten the fuel line nuts to a torque of 40.7 ± 6.8 N·m (30 ± 5 lb. ft.).



Suggest:

For more complete manuals. Please go to the home page.

<https://www.ebooklibonline.com>

If the above button click is invalid. Please download this document first, and then click the above link to download the complete manual.

Thank you so much for reading

Product: TRACK-TYPE TRACTOR

Model: D4E TRACK-TYPE TRACTOR 31C

Configuration: D4E TRACTORS / POWER SHIFT / 31C00100-UP (MACHINE) POWERED BY 3304 ENGINE

Disassembly and Assembly 3304 & 3306 VEHICULAR ENGINE

Media Number -SEN2824-00

Publication Date -01/01/1983

Date Updated -11/10/2001

Fuel Injection Pump and Governor

SMCS - 1286-15; 1286-16

Remove Fuel Injection Pump And Governor

| | Tools Needed | A | B | C |
|--------|---------------------|---|---|---|
| 5P7307 | Engine Turning Tool | 1 | | |
| 8S2264 | Puller Group | | 1 | |
| 8B7560 | Step Plate | | 1 | |
| 6F7031 | Bolt | | 2 | |
| 5M2894 | Washer | | 2 | |
| FT1635 | Timing Pin | | | 1 |

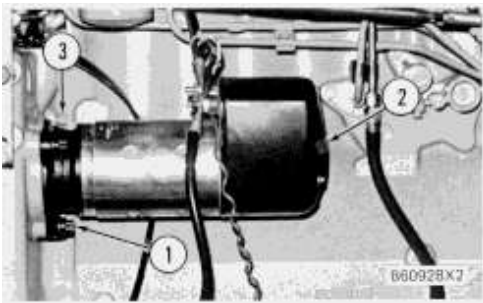

1. Disconnect the wires (not shown) from the starter. Fasten a hoist to the starter. Remove three bolts (1) and remove starter (2). Remove the gasket. The weight of the starter is 29 kg (64 lb.).

2. Remove plug (3) from the flywheel housing.

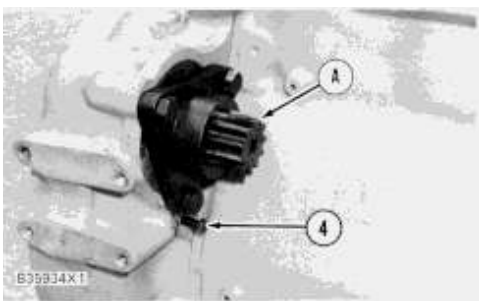

3. Install tooling (A) in the flywheel housing.

NOTE: No. 1 piston at top center (TC) on the compression stroke is the starting point for all timing procedures.

NOTE: The engine is seen from the flywheel end when direction of crankshaft rotation is given.

4. To find top center compression stroke for No. 1 piston, first turn the flywheel clockwise (opposite the direction of engine rotation) approximately 30 degrees. This procedure is to remove all play from the timing gears. Turn the flywheel counterclockwise until a 3/8"-16 NC bolt (4) can be installed in the flywheel through the hole in the flywheel housing. The No. 1 and No. 6 pistons are now at top center position.

NOTICE

If you go past the bolt hole you must start over with Step 2.

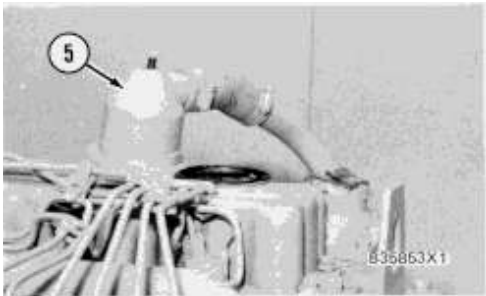

5. Remove breather (5) from the valve cover.

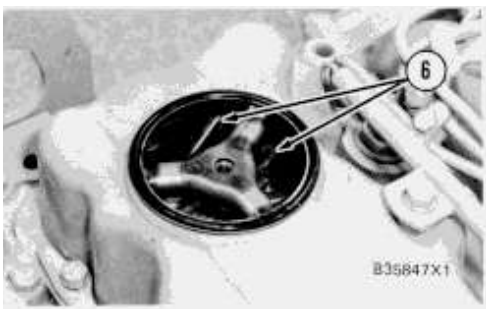

6. To see if the No. 1 piston is on the compression stroke, look at the valves of the No. 1 cylinder. The valves will be closed if No. 1 cylinder is on the compression stroke. You must be able to move both rocker arms (6) up and down with your hand.

7. If No. 1 piston is not on the compression stroke, remove the 3/8"-16 NC bolt (4) and turn the flywheel 360° counterclockwise. Install the 3/8" bolt as before. The No. 1 piston is now at top center (TC) on the compression stroke.

<https://www.ebooklibonline.com>

Hello dear friend!

Thank you very much for reading.

Enter the link into your browser.

The full manual is available for immediate download.

<https://www.ebooklibonline.com>