

Product: TRUCK

Model: 797 TRUCK 5YW

Configuration: 797 Off-Highway Truck 5YW00001-UP (MACHINE) POWERED BY 3524B Engine

## Disassembly and Assembly 3524B Engine for Caterpillar Built Machines

Media Number -REN2276-11

Publication Date -01/09/2018

Date Updated -14/09/2018

i05006674

## Front Drive Housing - Remove and Install

SMCS - 1151-010

S/N - 2CS1-UP

S/N - 3TN1-UP

S/N - 5YW1-UP

S/N - JSM1-UP

## Removal Procedure

Table 1

Required Tools			
Tool	Part Number	Part Description	Qty
A	180-3033	Repair Stand	2
B	138-7575	Link Bracket	2
C		3/8 inch - 16 NC by 1 1/2 inch Bolt	2
D	6V-9510	Face Seal Plug	1
	6V-9831	Cap As	1

### Start By:

- a. Remove the front crankshaft seal. Refer to Disassembly and Assembly, "Crankshaft Front Seal and Wear Sleeve - Remove".
- b. Remove the engine oil pump. Refer to Disassembly and Assembly, "Engine Oil Pump - Remove".

- c. Remove the coupling pump. Refer to Disassembly and Assembly, "Coupling Pump - Remove".

**Note: TOOLING (D) WILL NOT BE IDENTIFIED IN PHOTOGRAPHS IN THE REMOVAL OR THE INSTALLATION. THIS TOOLING IS SHOWN IN ORDER TO ASSIST THE EXPERIENCED SERVICEMAN.**

---

### NOTICE

**Care must be taken to ensure that fluids are contained during performance of inspection, maintenance, testing, adjusting, and repair of the product. Be prepared to collect the fluid with suitable containers before opening any compartment or disassembling any component containing fluids.**

**Refer to Special Publication, NENG2500, "Dealer Service Tool Catalog" for tools and supplies suitable to collect and contain fluids on Cat products.**

**Dispose of all fluids according to local regulations and mandates.**

---

---

### NOTICE

**Keep all parts clean from contaminants.**

**Contaminants may cause rapid wear and shortened component life.**

---



Illustration 1

g00910453

1. Remove tube assemblies (1).
-

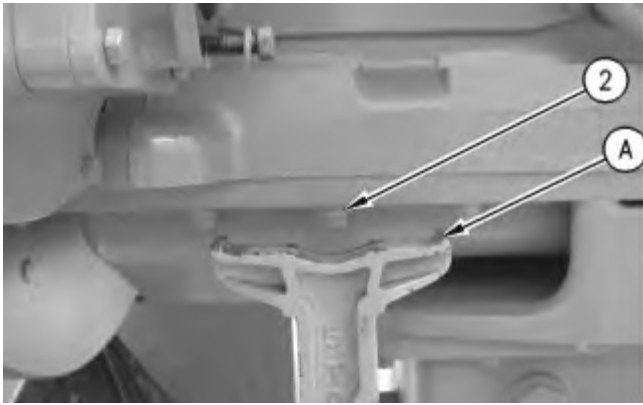

Illustration 2

g00910455

2. Remove bolt (2) and install Tooling (A).
3. Repeat Step 2 for the opposite side of the engine.

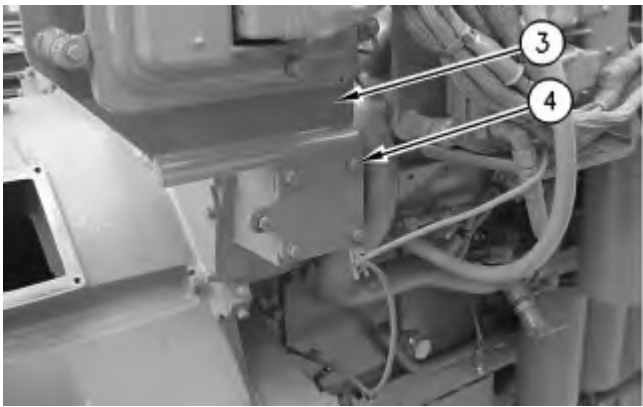

Illustration 3

g00910458

4. Remove bolts (4) and lay bracket (3) to the side.

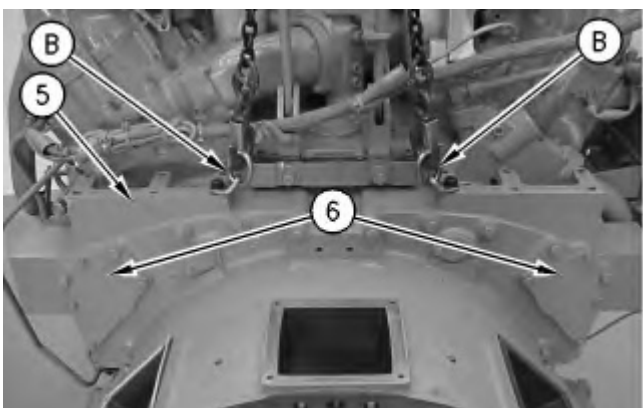

Illustration 4

g00910461

5. Attach Tooling (B) to front drive housing (5) and a suitable lifting device. Remove covers (6).

**<https://www.ebooklibonline.com>**

Hello dear friend!

Thank you very much for reading.

Enter the link into your browser.

The full manual is available for immediate download.

**<https://www.ebooklibonline.com>**

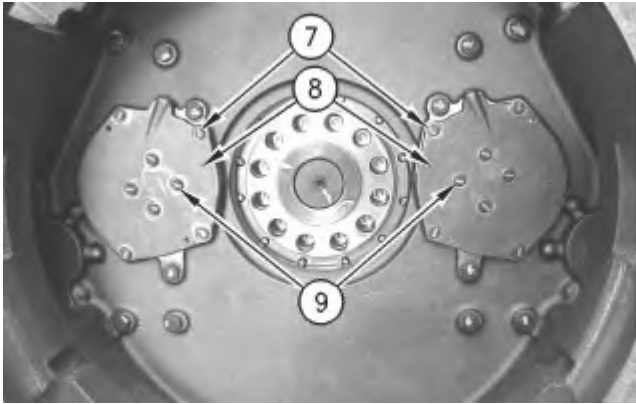

Illustration 5

g00910464

6. Remove bolts (7) from flanges (8).
7. Remove bolts (9) from flanges (8).

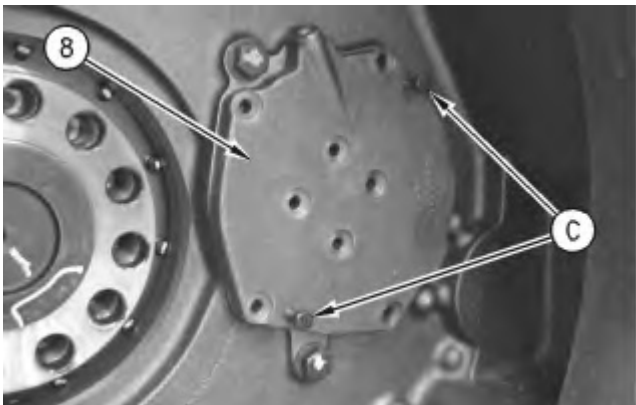

Illustration 6

g00910466

8. Use Tooling (C) in order to remove flanges (8).



Illustration 7

g00910469

9. Remove O-ring seals (10) from flanges (8).

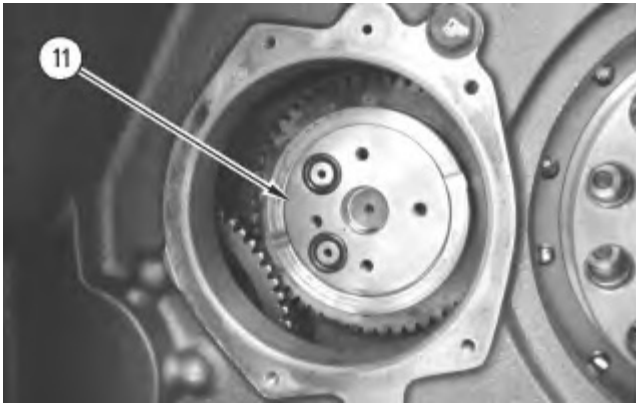

Illustration 8

g00910470

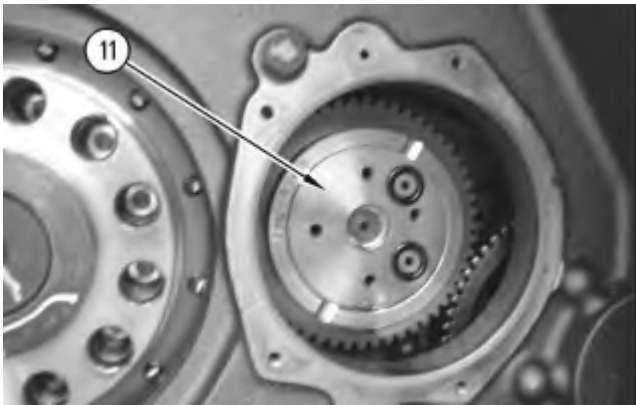

Illustration 9

g00910473

10. Remove shafts (11).

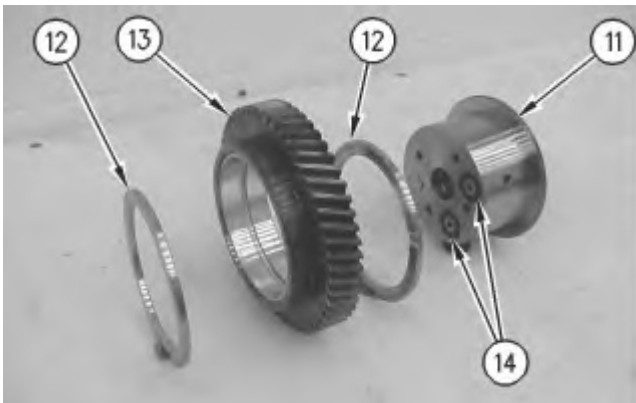

Illustration 10

g00910475

11. Remove thrust washers (12), gear assembly (13), and O-ring seals (14) from shaft (11).

12. Repeat Step 11 for other shaft (11).

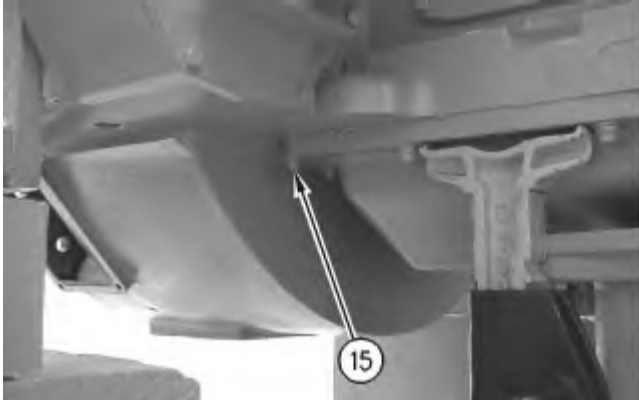

Illustration 11

g00910476

13. Remove bolts (15).



Illustration 12

g00910477

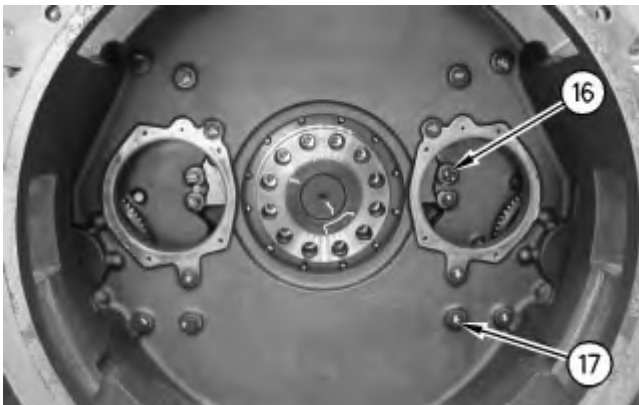

Illustration 13

g00910479

14. Remove bolts (16) from front drive housing (5).
15. Remove bolts (17) from front drive housing (5). Remove front drive housing (5) from the engine. The weight of front drive housing (5) is approximately 635 kg (1400 lb).

## Installation Procedure

Table 2

Required Tools			
Tool	Part Number	Part Description	Qty
A	180-3033	Repair Stand	2
B	138-7575	Link Bracket	2
E	-	Loctite 5127	-
F		3/8 - 16 NC by 5 inch Guide Bolt	2

---

**NOTICE**

**Keep all parts clean from contaminants.**

**Contaminants may cause rapid wear and shortened component life.**

---

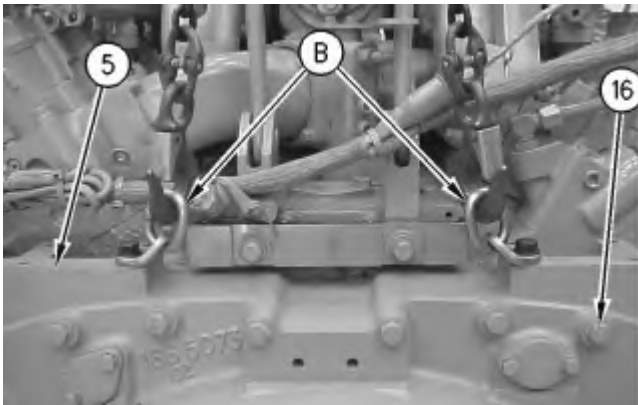

Illustration 14

g00910745



Illustration 15

g00910479

1. Attach Tooling (B) to front drive housing (5) and a suitable lifting device. The weight of front drive housing (5) is approximately 635 kg (1400 lb). Apply Tooling (E) to the face of front drive housing (5).
2. Position front drive housing (5) to the engine and install bolts (16). Tighten bolts (16) to a torque of  $135 \pm 20$  N·m ( $100 \pm 15$  lb ft).
3. Install bolts (17). Tighten bolts (16) to a torque of  $270 \pm 40$  N·m ( $200 \pm 30$  lb ft).

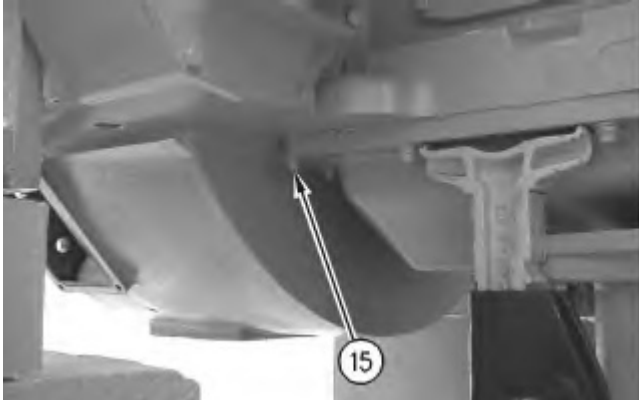

Illustration 16

g00910476

4. Install bolts (15).

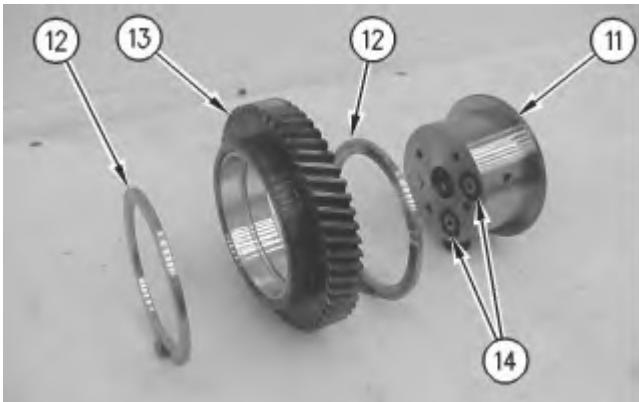

Illustration 17

g00910475

5. Install thrust washers (12), gear assembly (13), and O-ring seals (14) to shaft (11).
-

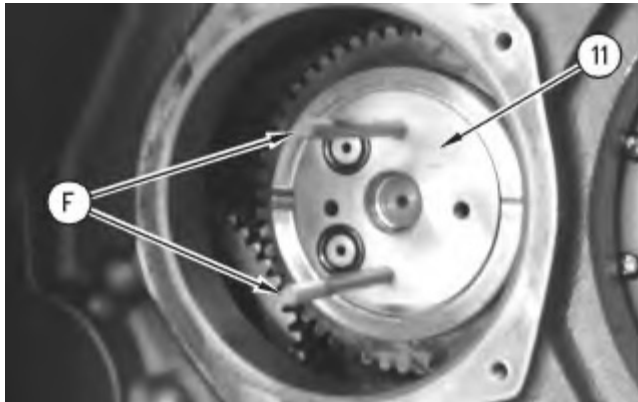

Illustration 18

g00910767

6. Install shaft (11). Install Tooling (F) to shaft (11).



Illustration 19

g00910469

7. Install O-ring seals (10) to flange (8).

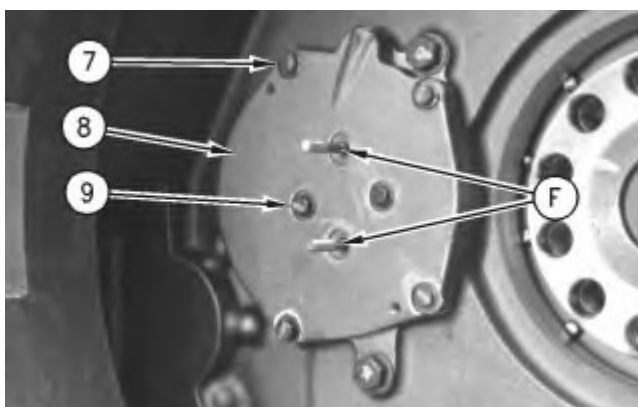

Illustration 20

g00910775

8. Install flange (8), bolts (7), and bolts (9). Remove Tooling (F) and install remaining bolts (9).
9. Repeat Step 5 through Step 8 for the other shaft (11) and flange (8).

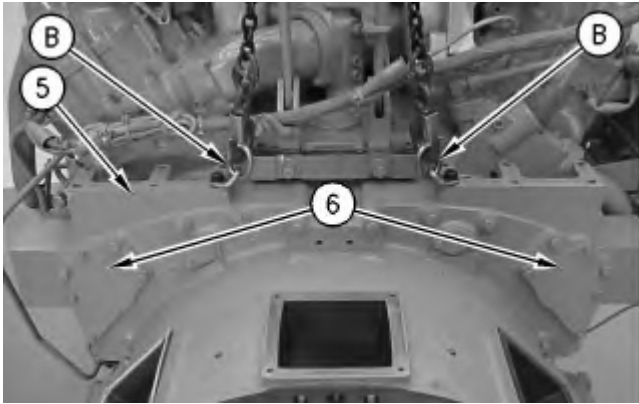

Illustration 21

g00910461

10. Install covers (6) to front drive housing (5). Remove Tooling (B) from front drive housing (5).

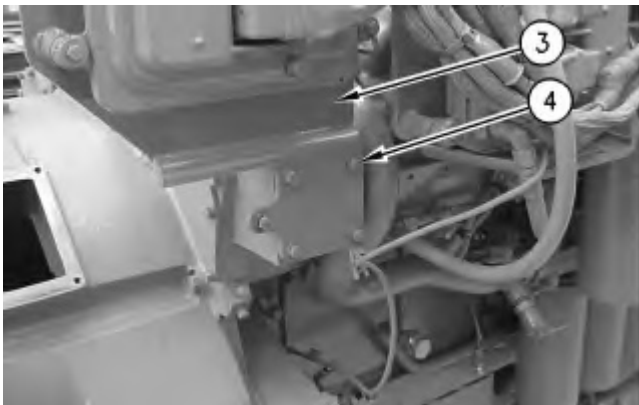

Illustration 22

g00910458

11. Install bolts (4) in order to attach bracket (3) to the engine.

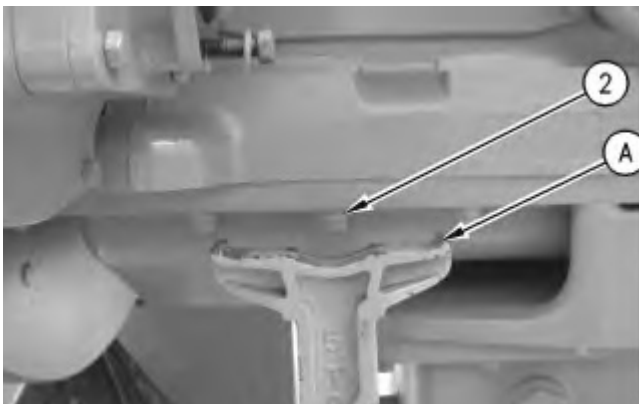
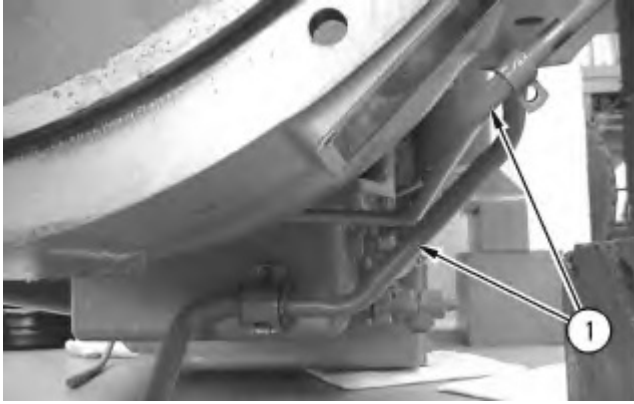

Illustration 23

g00910455

12. Remove Tooling (A) and install bolt (2).
13. Repeat Step 12 for the opposite side of the engine.



---

Illustration 24

g00910453

14. Install tube assemblies (1).

**End By:**

- a. Install the coupling pump. Refer to Disassembly and Assembly, "Coupling Pump - Install".
  - b. Install the engine oil pump. Refer to Disassembly and Assembly, "Engine Oil Pump - Install".
  - c. Install the front crankshaft seal. Refer to Disassembly and Assembly, "Crankshaft Front Seal and Wear Sleeve - Install".
-

Product: TRUCK

Model: 797 TRUCK 5YW

Configuration: 797 Off-Highway Truck 5YW00001-UP (MACHINE) POWERED BY 3524B Engine

## Disassembly and Assembly 3524B Engine for Caterpillar Built Machines

Media Number -REN2276-11

Publication Date -01/09/2018

Date Updated -14/09/2018

i01784507

# Vibration Damper - Remove and Install

SMCS - 1205-010

S/N - 2CS1-UP

S/N - 3TN1-UP

S/N - 5YW1-UP

S/N - JSM1-UP

## Removal Procedure

Table 1

Required Tools			
Tool	Part Number	Part Description	Qty
A	6V-2078	Stud	2
B	138-7573	Link Bracket	2

### Start By:

- Remove the coupling. Refer to Disassembly and Assembly, "Coupling - Remove and Install".

---

### NOTICE

**Keep all parts clean from contaminants.**

**Contaminants may cause rapid wear and shortened component life.**

---

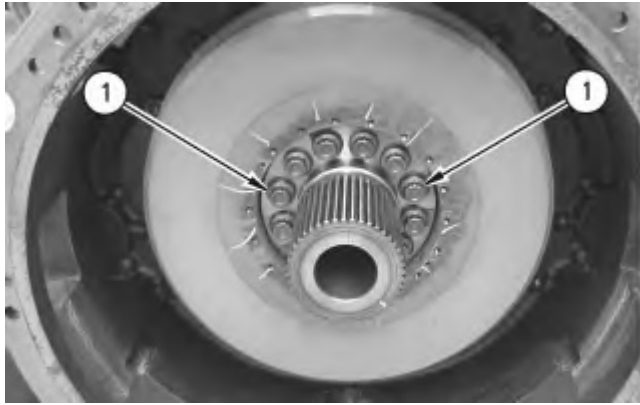

---

Illustration 1

g00912784

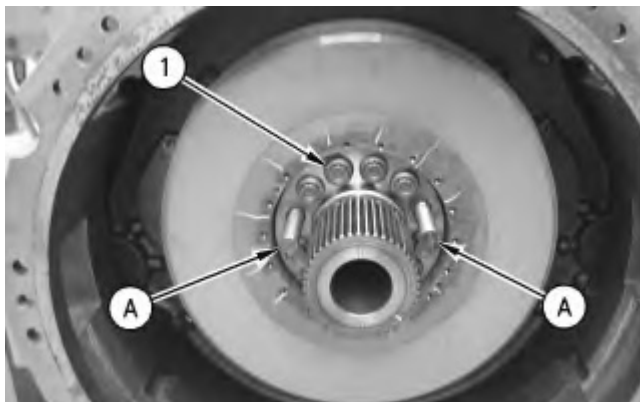

---

Illustration 2

g00912785

1. Remove two bolts (1) and install Tooling (A). Remove remaining bolts (1).

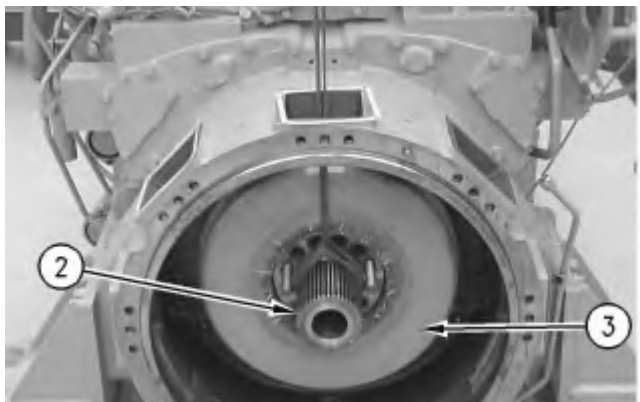

---

Illustration 3

g00912786

2. Attach a suitable lifting device to shaft (2). Remove shaft (2) from damper (3). The weight of shaft (2) is approximately 32 kg (70 lb).
-

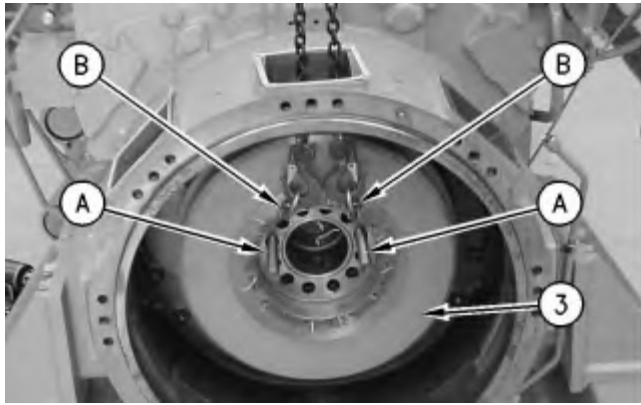

Illustration 4

g00912787

3. Attach Tooling (B) to damper (3) and a suitable lifting device. Remove Tooling (A). Remove damper (3). The weight of damper (3) is approximately 204 kg (450 lb).

## Installation Procedure

Table 2

Required Tools			
Tool	Part Number	Part Description	Qty
A	6V-2078	Stud	2
B	138-7573	Link Bracket	2
C	6V-7820	Torque Multiplier Gp	1

---

### NOTICE

**Keep all parts clean from contaminants.**

**Contaminants may cause rapid wear and shortened component life.**

---

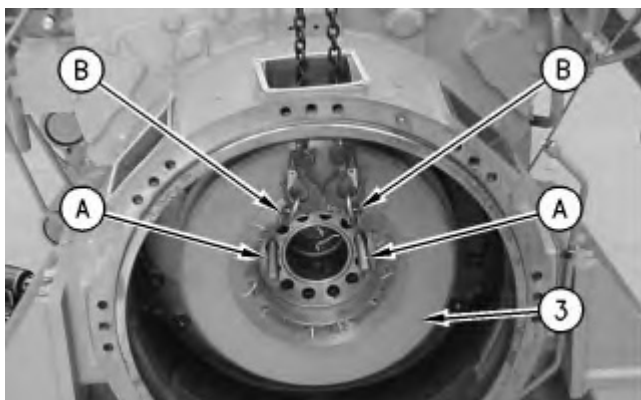

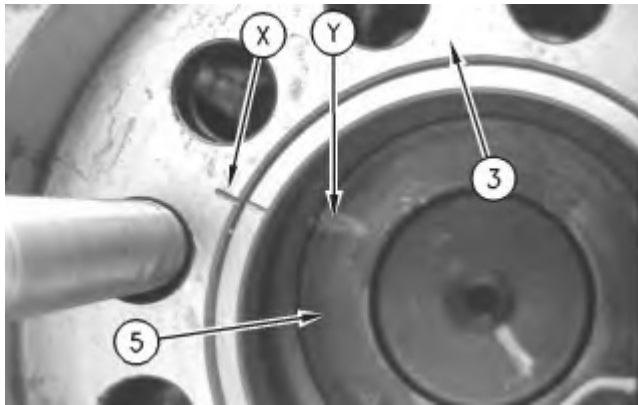

Illustration 6

1. Attach Tooling (B) to damper (3) and a suitable lifting device. The weight of damper (3) is approximately 204 kg (450 lb). Position damper (3) to crankshaft (5). Timing mark (X) that is located on damper (3) must be aligned with timing mark (Y) that is located on crankshaft (5).
2. Install Tooling (A) and remove Tooling (B).

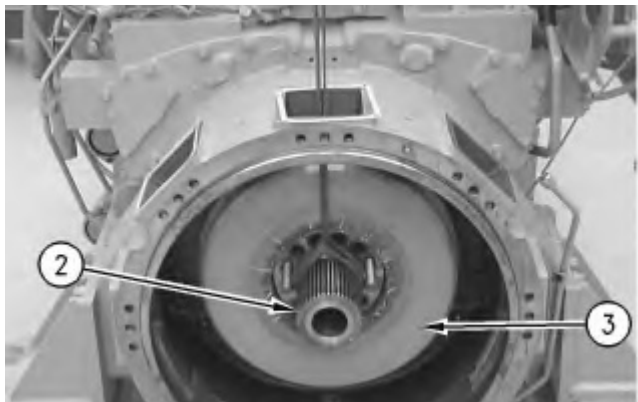
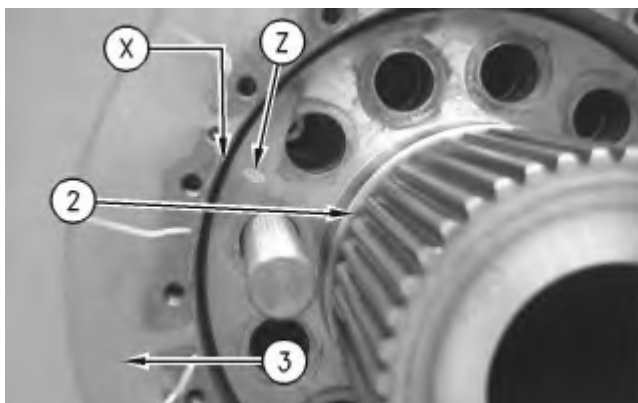

Illustration 7



3. Attach a suitable lifting device to shaft (2) and position shaft (3) to damper (3). The weight of shaft (2) is approximately 32 kg (70 lb). Timing mark (Z) that is located on shaft (2) must be aligned with timing mark (X) (not shown) that is located on damper (3).

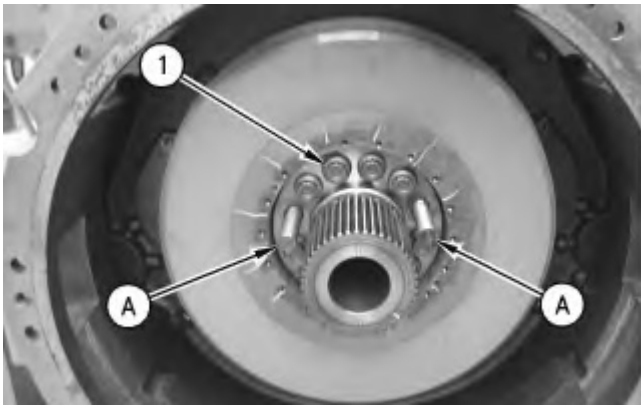

Illustration 9

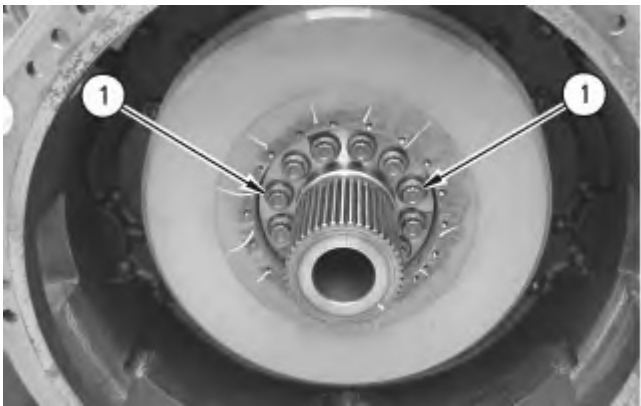

Illustration 10

4. Install bolts (1). Remove Tooling (A) and install remaining bolts (1).

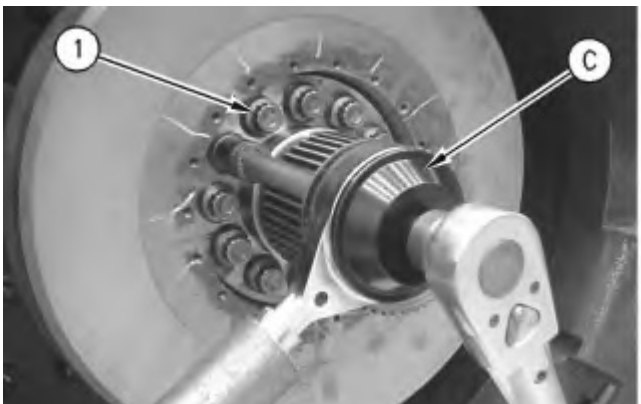

Illustration 11

5. Use Tooling (C) in order to tighten bolts (1) to a torque of  $1125 \pm 100$  N·m ( $830 \pm 74$  lb ft).

**End By:**

a. Install the coupling. Refer to Disassembly and Assembly, "Coupling - Remove and Install".

---

Product: TRUCK

Model: 797 TRUCK 5YW

Configuration: 797 Off-Highway Truck 5YW00001-UP (MACHINE) POWERED BY 3524B Engine

## Disassembly and Assembly 3524B Engine for Caterpillar Built Machines

Media Number -REN2276-11

Publication Date -01/09/2018

Date Updated -14/09/2018

i01782527

# Crankshaft Front Seal and Wear Sleeve - Remove

SMCS - 1160-011; 7558-011

S/N - 2CS1-UP

S/N - 3TN1-UP

S/N - 5YW1-UP

S/N - JSM1-UP

## Removal Procedure

Table 1

Required Tools			
Tool	Part Number	Part Description	Qty
A	1U-7600	Slide Hammer Puller Gp	1
B	5P-7409	Sleeve Distorter	1
	1U-7325	Adapter	1

### Start By:

- a. Remove the vibration damper. Refer to Disassembly and Assembly, "Vibration Damper - Remove and Install".

---

### NOTICE

**Keep all parts clean from contaminants.**

**Contaminants may cause rapid wear and shortened component life.**



Illustration 1

g00911707

1. Use Tooling (A) in order to remove crankshaft seal (1).



Illustration 2

g00911708

2. Use Tooling (B) in order to remove crankshaft wear sleeve (2).
-



**Suggest:**

**For more complete manuals. Please go to the home page.**

**<https://www.ebooklibonline.com>**

**If the above button click is invalid. Please download this document first, and then click the above link to download the complete manual.**

**Thank you so much for reading**

Product: TRUCK

Model: 797 TRUCK 5YW

Configuration: 797 Off-Highway Truck 5YW00001-UP (MACHINE) POWERED BY 3524B Engine

## Disassembly and Assembly 3524B Engine for Caterpillar Built Machines

Media Number -REN2276-11

Publication Date -01/09/2018

Date Updated -14/09/2018

i06603192

# Crankshaft Front Seal and Wear Sleeve - Install

SMCS - 1160-012; 7558-012

S/N - 2CS1-UP

S/N - 3TN1-UP

S/N - 5YW1-UP

S/N - JSM1-UP

## Installation Procedure For Seals 113-8432 and 113-8433

Table 1

Required Tools			
Tool	Part Number	Part Description	Qty
D	6V-4003 <sup>(1)</sup>	Seal Locator As	1
	2N-5006 <sup>(1)</sup>	Bolt	2
E	8T-3099 <sup>(1)</sup>	Seal Installer	1
F	9S-8858 <sup>(1)</sup>	Nut	1
G	-	Loctite 7649 Primer N	1
H	-	Loctite 620 Retaining Compound	1
J	452-6011	Multipurpose Grease	1
K	484-7863 <sup>(2)</sup>	Tool As	1

<sup>(1)</sup> For installation of seals 113-8432 and 113-8433

<sup>(2)</sup> For Installation of seals 436-1478 and 436-1479

---

## NOTICE

**Keep all parts clean from contaminants.**

**Contaminants may cause rapid wear and shortened component life.**

---

---

## NOTICE

**Every time that the crankshaft seal is removed from the wear sleeve, a new wear sleeve and crankshaft seal must be installed.**

---

---

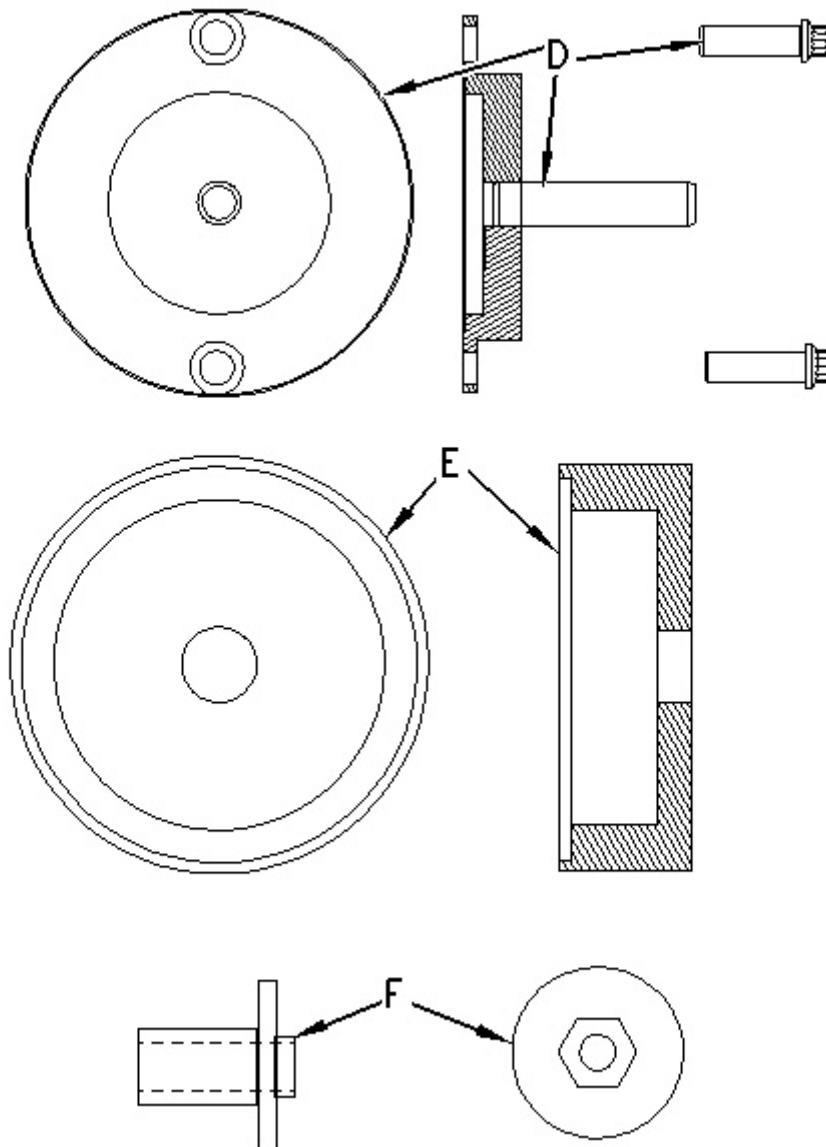

**<https://www.ebooklibonline.com>**

Hello dear friend!

Thank you very much for reading.

Enter the link into your browser.

The full manual is available for immediate download.

**<https://www.ebooklibonline.com>**