

Product: TRUCK

Model: 794 AC TRUCK MT5

Configuration: 794 AC Off-Highway Truck MT500001-UP (MACHINE) POWERED BY C175-16 Engine

Disassembly and Assembly C175-16 Engine for Caterpillar Built Machines

Media Number -UENR5561-02

Publication Date -01/02/2018

Date Updated -02/02/2018

i07474886

Inlet and Exhaust Valve Springs - Remove and Install

SMCS - 1108-010

Removal Procedure - Cylinder Head On Engine

Table 1

Required Tools			
Tool	Part Number	Part Description	Qty
A	459-4664	Valve Spring Compressor	1
B	279-3473	Barring and Mounting Gp	1

Start By:

- a. Remove valve cover.
1. Use Tooling (B) to rotate the engine so that the piston beneath the cylinder head being serviced is at top dead center.

Note: If the piston is not at top dead center, valves may drop down into the cylinder.

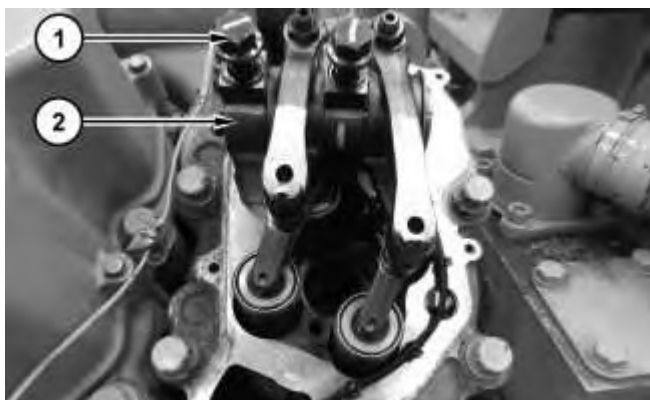

2. Remove bolts (1) and rocker shaft assembly (2).

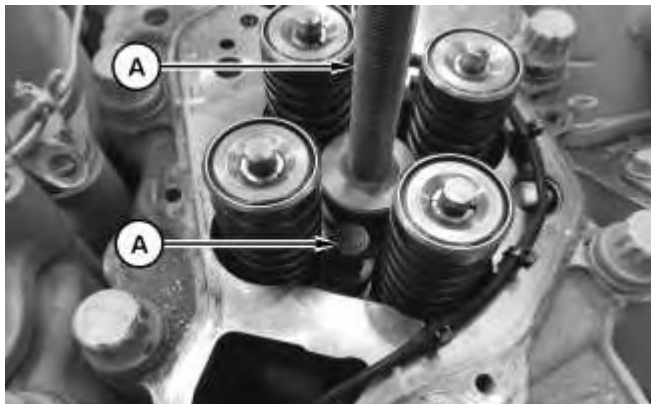
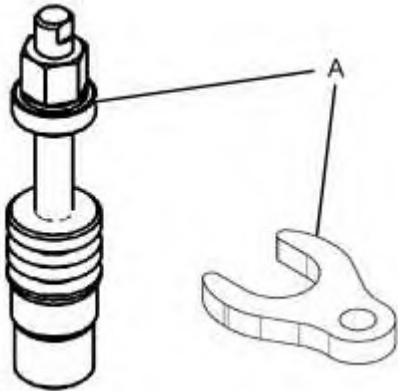

3. Install Tooling (A) into the hole for the electronic unit injector. Refer to the Tool Operating Manual, NEHS1205.



WARNING

Personal injury can result from being struck by parts propelled by a released spring force.

Make sure to wear all necessary protective equipment.

Follow the recommended procedure and use all recommended tooling to release the spring force.

4. Install the plate of Tooling (A) onto the valve springs. Install the nut onto the stud. Tighten the nut to compress valve springs (2). Remove retainer locks (1).
-

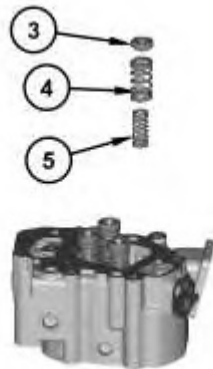

Illustration 5

g01298522

5. Remove Tooling (A). Remove rotocoil (3), outer spring (4), and inner spring (5).
6. Repeat Step 5 for the remaining valve springs.

Removal Procedure - Cylinder Head Off Engine

Table 2

Required Tools			
Tool	Part Number	Part Description	Qty
A	333-0758	Valve Spring Compressor	1

Start By:

- a. Remove the cylinder head.
-

<https://www.ebooklibonline.com>

Hello dear friend!

Thank you very much for reading.

Enter the link into your browser.

The full manual is available for immediate download.

<https://www.ebooklibonline.com>

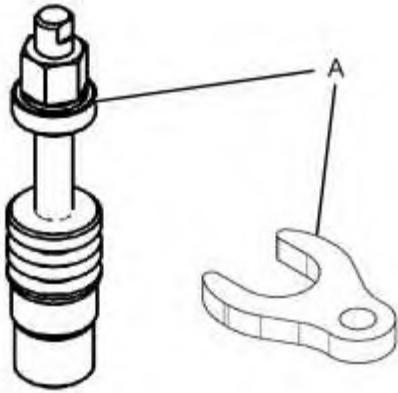

Illustration 6

g03500636

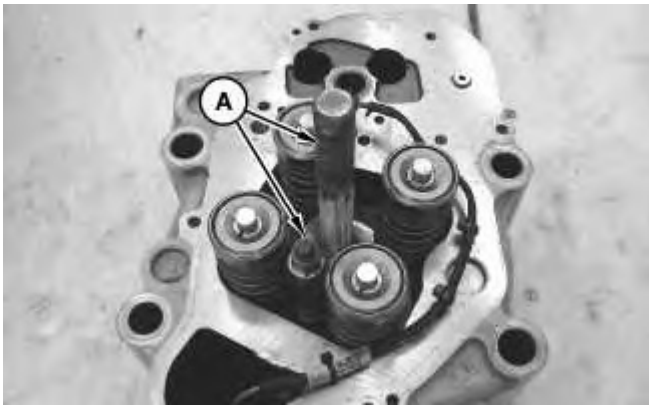

Illustration 7

g01207146

1. Install Tooling (A) into the hole for the electronic unit injector. Refer to Illustration 7.

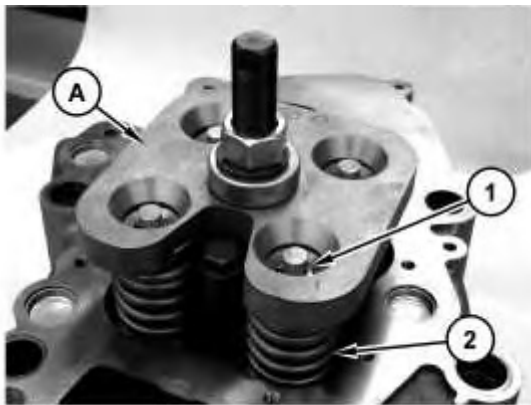

Illustration 8

g01851274

 **WARNING**

Personal injury can result from being struck by parts propelled by a released spring force.

Make sure to wear all necessary protective equipment.

Follow the recommended procedure and use all recommended tooling to release the spring force.

2. Install the plate of Tooling (A) onto the valve springs. Install the nut onto the stud. Tighten the nut to compress valve springs (2). Remove retainer locks (1).
-

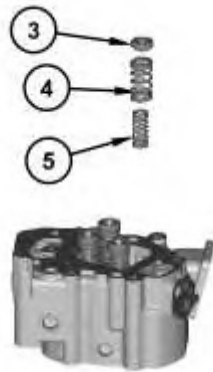

Illustration 9

g01298522

3. Remove Tooling (A). Remove rotocoil (3), outer spring (4), and inner spring (5).
4. Repeat Step 3 for the remaining valve springs.

Installation Procedure

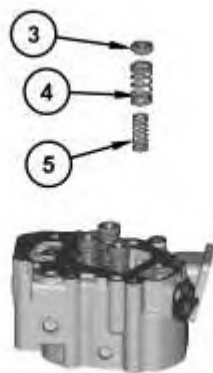

Illustration 10

g01298522



WARNING

Improper assembly of parts that are spring loaded can cause bodily injury.

To prevent possible injury, follow the established assembly procedure and wear protective equipment.

1. Install inner spring (5), outer spring (4), and rotocoil (3).

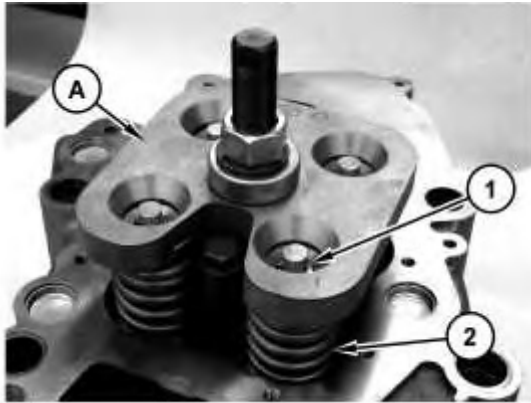

Illustration 11

g01851274

2. Use Tooling (A) to compress valve springs (2). Install retainer locks (1). Release the tension on valve springs (2). Remove Tooling (A).
3. Repeat Steps 1 through 2 for the remaining valve springs.

End By:

- a. Install the cylinder head.
-

Product: TRUCK

Model: 794 AC TRUCK MT5

Configuration: 794 AC Off-Highway Truck MT500001-UP (MACHINE) POWERED BY C175-16 Engine

Disassembly and Assembly C175-16 Engine for Caterpillar Built Machines

Media Number -UENR5561-02

Publication Date -01/02/2018

Date Updated -02/02/2018

i07474929

Inlet and Exhaust Valves - Remove and Install

SMCS - 1105-010

Removal Procedure

Table 1

Required Tools			
Tool	Part Number	Part Description	Qty
A	459-4664	Valve Spring Compressor	1

Start By:

- a. Remove the electronic unit injector. Refer to Disassembly and Assembly, "Electronic Unit Injector - Remove".
- b. Remove the cylinder head. Refer to Disassembly and Assembly, "Cylinder Head - Remove".

NOTICE

Keep all parts clean from contaminants.

Contaminants may cause rapid wear and shortened component life.

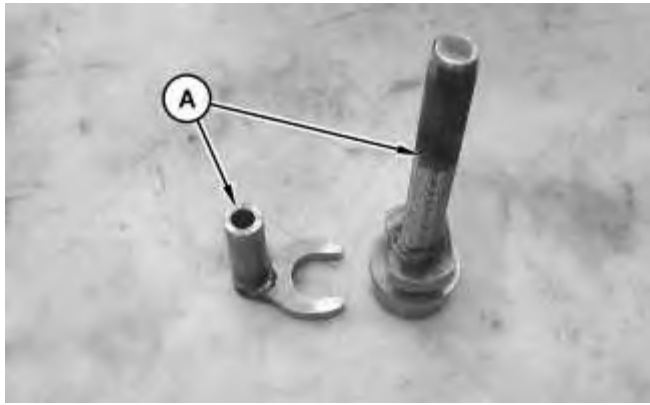

Illustration 1

g01206603

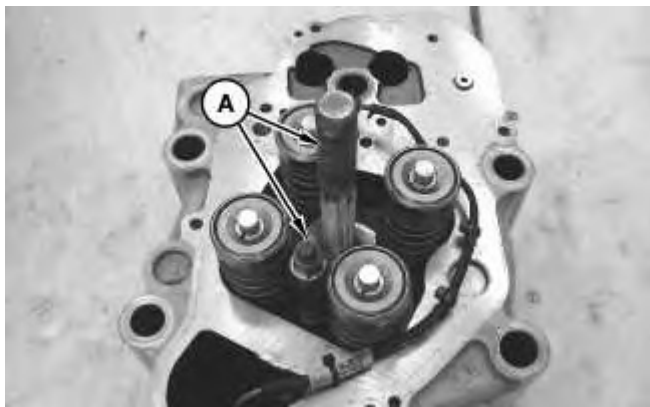

Illustration 2

g01207146

1. Install Tooling (A) into the hole for the electronic unit injector. Refer to Illustration 2. Refer to the Tool Operating Manual, NEHS1205.



Illustration 3

g01851274

 **WARNING**

Personal injury can result from being struck by parts propelled by a released spring force.

Make sure to wear all necessary protective equipment.

Follow the recommended procedure and use all recommended tooling to release the spring force.

2. Install the plate of Tooling (A) onto the valve springs. Refer to Illustration 3. Install the nut onto the stud. Tighten the nut to compress valve springs (2). Remove retainer locks (1).
-

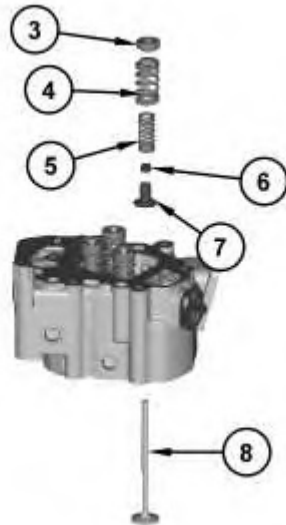

Illustration 4

g01206605

3. Remove Tooling (A). Remove rotocoil (3), outer spring (4), inner spring (5), valve seal (6), retainer (7), and valve (8).

Installation Procedure

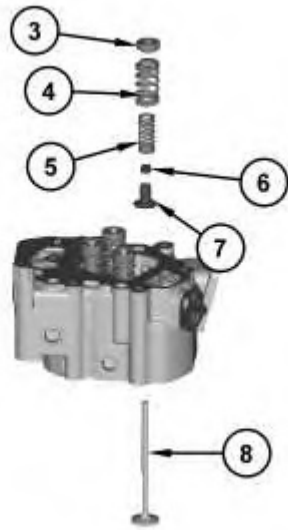

Illustration 5

g01206605

1. Install valve (8), retainer (7), valve seal (6), inner spring (5), outer spring (4), and rotocoil (3).

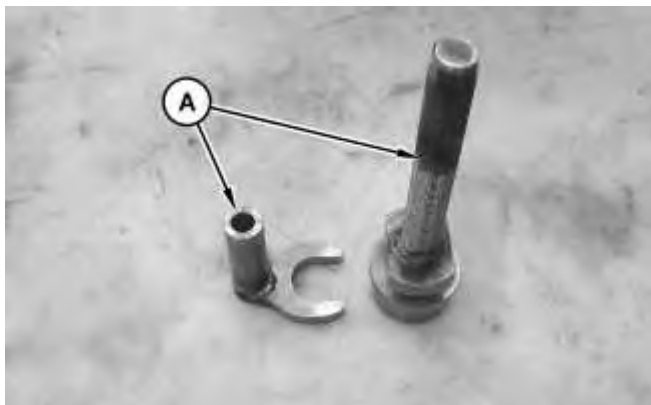

Illustration 6

g01206603



Illustration 7

g01228542

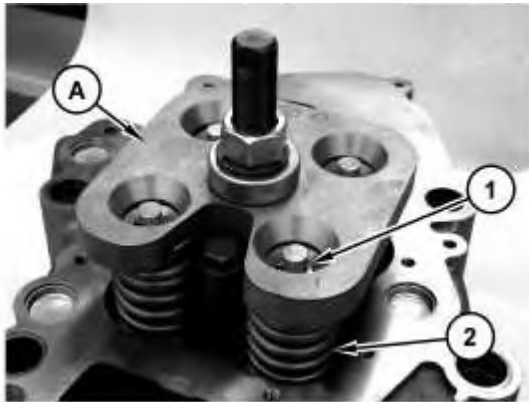

Illustration 8

g01851274

WARNING

Improper assembly of parts that are spring loaded can cause bodily injury.

To prevent possible injury, follow the established assembly procedure and wear protective equipment.

2. Use Tooling (A) to compress valve springs (2). Install retainer locks (1). Release the tension on valve springs (2). Remove Tooling (A). Install a screwdriver into the hole for the injector. Slowly rotate the engine until the piston is approximately 25 mm (1.00 inch) below top dead center. Lightly strike the tops of the valves with a soft faced hammer to ensure that retainer locks (1) are properly seated.

End By:

- a. Install the cylinder head. Refer to Disassembly and Assembly, "Cylinder Head - Install".
 - b. Install the electronic unit injector. Refer to Disassembly and Assembly, "Electronic Unit Injector - Install".
-

Product: TRUCK

Model: 794 AC TRUCK MT5

Configuration: 794 AC Off-Highway Truck MT500001-UP (MACHINE) POWERED BY C175-16 Engine

Disassembly and Assembly C175-16 Engine for Caterpillar Built Machines

Media Number -UENR5561-02

Publication Date -01/02/2018

Date Updated -02/02/2018

i02413949

Inlet and Exhaust Valve Guides - Remove and Install

SMCS - 1104-010

Removal Procedure

Table 1

Required Tools			
Tool	Part Number	Part Description	Qty
A	283-0052	Valve guide driver	1

Start By:

- Remove the inlet and exhaust valves. Refer to Disassembly and Assembly, "Inlet and Exhaust Valves - Remove and Install".

NOTICE

Keep all parts clean from contaminants.

Contaminants may cause rapid wear and shortened component life.

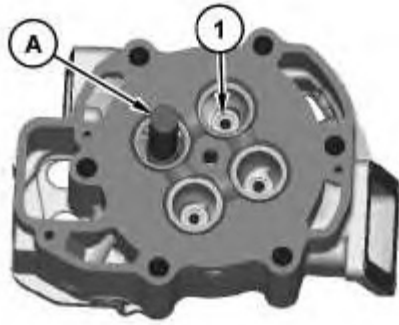

Illustration 1

g01206606

1. Turn over the cylinder head. Use Tooling (A) and a suitable hammer in order to remove valve guides (1) from the cylinder head.

Installation Procedure

Table 2

Required Tools			
Tool	Part Number	Part Description	Qty
A	283-0052	Valve guide driver	1
B	284-1503	Collar	1

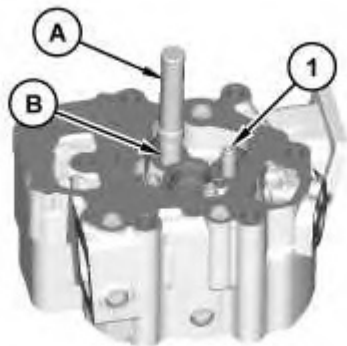

Illustration 2

g01211260

1. Coat the outside of the valve guides with clean oil prior to installation. Use Tooling (A), Tooling (B), and a suitable hammer in order to install valve guides (1) into the cylinder head. Valve guide (1) must extend 42.0 ± 0.50 mm (1.65 ± 0.020 inch) above the surface of the cylinder head.

End By:

- a. Install the inlet and exhaust valves. Refer to Disassembly and Assembly, "Inlet and Exhaust Valves - Remove and Install".
-

Product: TRUCK

Model: 794 AC TRUCK MT5

Configuration: 794 AC Off-Highway Truck MT500001-UP (MACHINE) POWERED BY C175-16 Engine

Disassembly and Assembly C175-16 Engine for Caterpillar Built Machines

Media Number -UENR5561-02

Publication Date -01/02/2018

Date Updated -02/02/2018

i07475180

Inlet Valve Seals - Remove and Install

SMCS - 1104-010-SA

Removal Procedure

Table 1

Required Tools			
Tool	Part Number	Part Description	Qty
A	459-4664	Valve Spring Compressor	1

Start By:

- a. Remove the cylinder head.

NOTICE

Keep all parts clean from contaminants.

Contaminants may cause rapid wear and shortened component life.

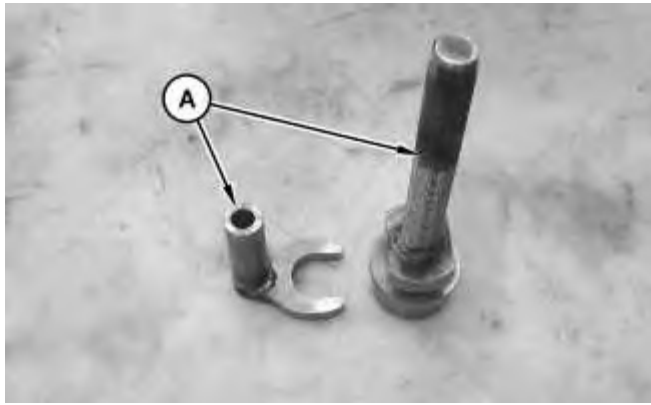

Illustration 1

g01206603

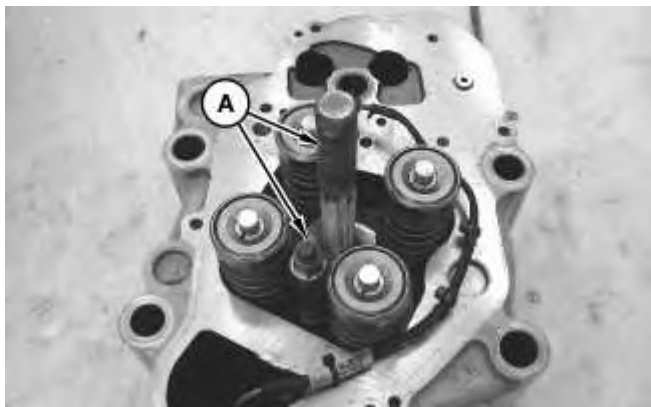

Illustration 2

g01207146

1. Install Tooling (A) into the hole for the electronic unit injector. Refer to Illustration 2. Refer to the Tool Operating Manual, NEHS1205.



Illustration 3

g01851274



WARNING

Personal injury can result from being struck by parts propelled by a released spring force.

Make sure to wear all necessary protective equipment.

Follow the recommended procedure and use all recommended tooling to release the spring force.

2. Install the plate of Tooling (A) onto the valve springs. Refer to Illustration 3. Install the nut onto the stud. Tighten the nut to compress valve springs (2). Remove retainer locks (1).
-

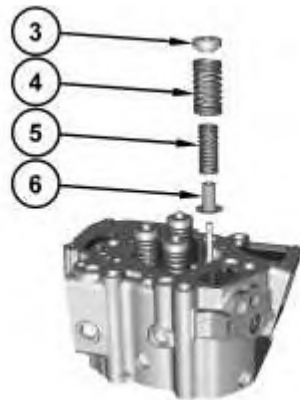

Illustration 4

g03736517

3. Remove Tooling (A). Remove rotocoil (3), outer spring (4), and inner spring (5). Remove valve seal (6).
4. Repeat Steps 1 through 3 for the remaining valve seals.

Installation Procedure

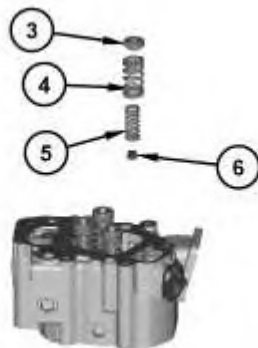

Illustration 5

g01298551



Suggest:

For more complete manuals. Please go to the home page.

<https://www.ebooklibonline.com>

If the above button click is invalid. Please download this document first, and then click the above link to download the complete manual.

Thank you so much for reading

WARNING

Improper assembly of parts that are spring loaded can cause bodily injury.

To prevent possible injury, follow the established assembly procedure and wear protective equipment.

1. Install a new valve seal (6). Install inner spring (5), outer spring (4), and rotocoil (3).

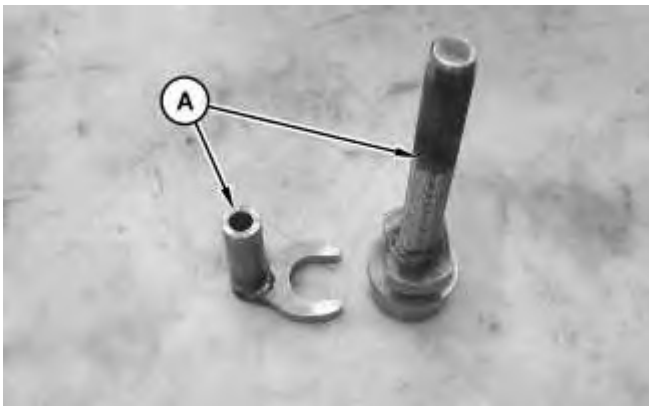

Illustration 6

g01206603



Illustration 7

g01228542



Illustration 8

g01851274

2. Use Tooling (A) to compress valve springs (2). Install retainer locks (1). Release the tension on valve springs (2). Remove Tooling (A).
3. Repeat Steps 1 through 2 for the remaining valve seals.

End By:

- a. Install the cylinder head.
-

<https://www.ebooklibonline.com>

Hello dear friend!

Thank you very much for reading.

Enter the link into your browser.

The full manual is available for immediate download.

<https://www.ebooklibonline.com>