

Product: TRUCK

Model: 789C TRUCK 2BW

Configuration: 789C Off-Highway Truck 2BW00001-UP (MACHINE) POWERED BY 3516 Engine

## Disassembly and Assembly 789C Off-Highway Truck Power Train

Media Number -SEN1524-10

Publication Date -01/09/2018

Date Updated -25/09/2018

i01090813

# Differential and Bevel Gear - Disassemble

SMCS - 3256-015; 3258-015

## Disassembly Procedure

Table 1

| Required Tools |             |                  |     |
|----------------|-------------|------------------|-----|
| Tool           | Part Number | Part Description | Qty |
| A              | FT-2392     | Adjusting Nut    | 1   |
| B              | FT-2393     | Adjusting Nut    | 1   |
| C              | 5P-1730     | Holding Fixture  | 1   |
| D              | 1P-0520     | Driver Group     | 1   |
| E              | 1H-3110     | Bearing Puller   | 1   |
| E              | 1H-3107     | Push Puller      | 1   |

### Start By:

- a. Remove the differential and bevel gear. Refer to Disassembly and Assembly, "Differential and Bevel Gear - Remove".

---

### NOTICE

Care must be taken to ensure that fluids are contained during performance of inspection, maintenance, testing, adjusting, and repair of the product. Be prepared to collect the fluid with suitable containers before opening any compartment or disassembling any component containing fluids.

**Refer to Special Publication, NENG2500, "Dealer Service Tool Catalog" for tools and supplies suitable to collect and contain fluids on Cat products.**

**Dispose of all fluids according to local regulations and mandates.**

---

**Note:** Cleanliness is an important factor. Before the disassembly procedure, the exterior of the component should be thoroughly cleaned. This will help to prevent dirt from entering the internal mechanism.

**Note:** Put identification marks on all hose assemblies and on all tube assemblies for installation purposes. Plug all hose assemblies and all tube assemblies. This helps to prevent fluid loss and this helps to prevent contaminants from entering the system.

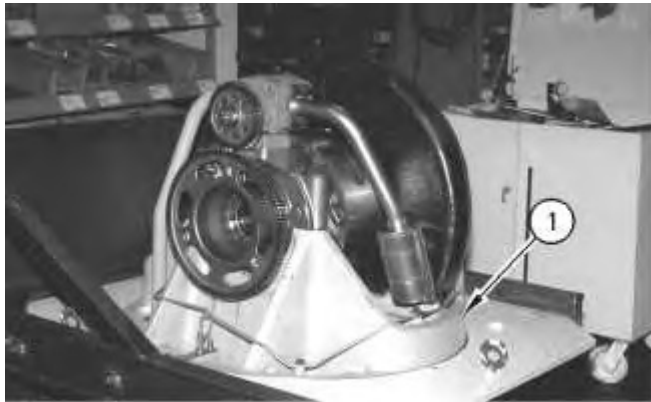

Illustration 1

g00572397



Illustration 2

g00572398

1. Use a suitable hoist in order to place differential carrier assembly (1) on the fixture. The weight of differential carrier assembly (1) is 907 kg (2000 lb).
-

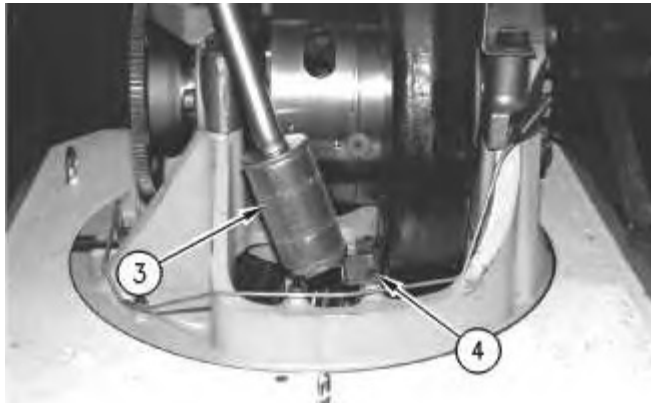

Illustration 3

g00572395

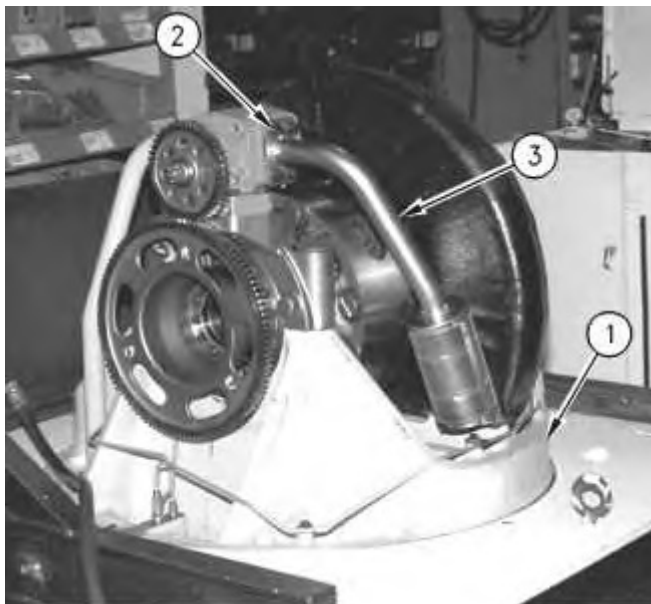
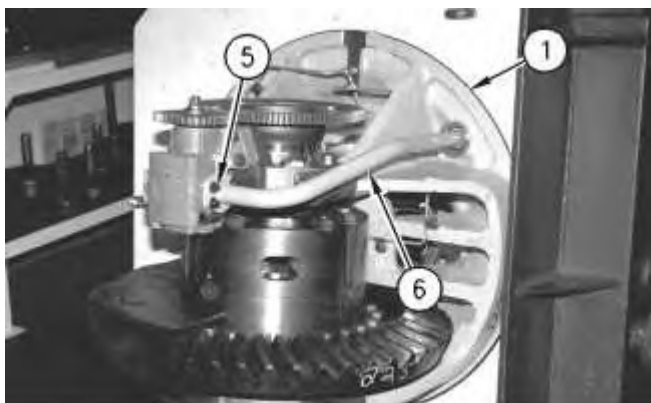

Illustration 4

g00572394

2. Remove two locking bolts (4) and the washers. Remove four twelve point head bolts (2) and the washers.
3. Remove tube assembly (3) from differential carrier assembly (1).



**<https://www.ebooklibonline.com>**

Hello dear friend!

Thank you very much for reading.

Enter the link into your browser.

The full manual is available for immediate download.

**<https://www.ebooklibonline.com>**

4. Remove four twelve point head bolts (5) and the washers.
5. Remove tube assembly (6) from differential carrier assembly (1). Remove the seals from tube assembly (6).

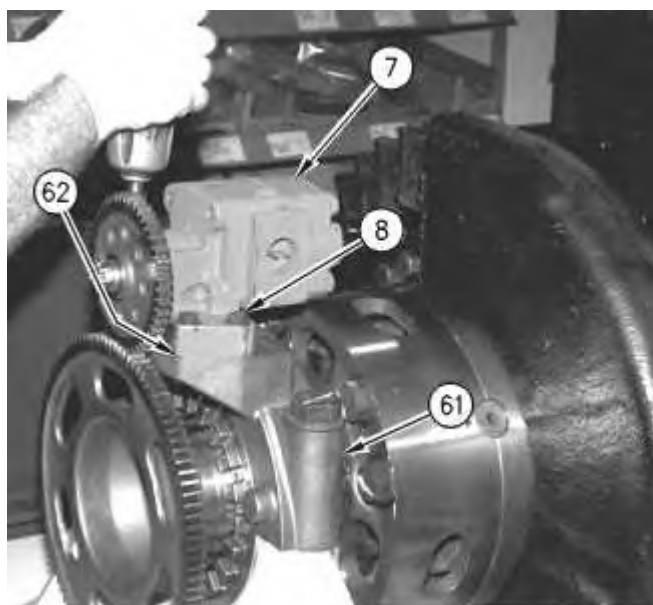

Illustration 6

g00572391

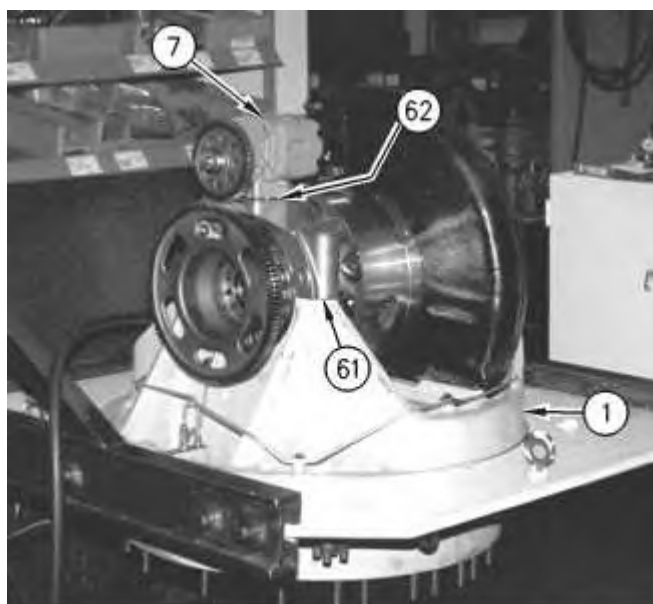

Illustration 7

g00572390

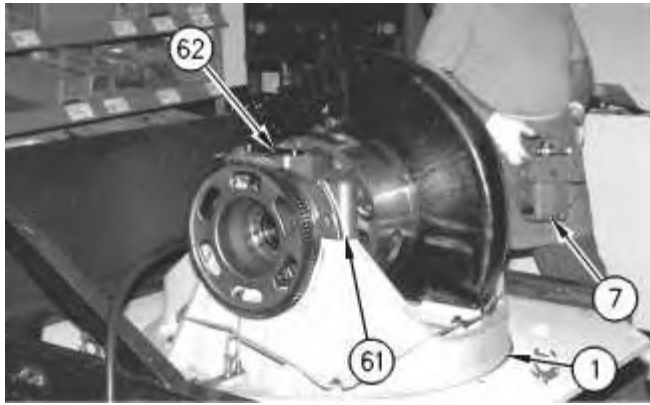

Illustration 8

g00572389

6. Rotate differential carrier assembly (1), as shown. Remove four bolts (8) and the washers. Remove gear pump assembly (7).

**Note:** Install the cover on the pump input. Install the cover on the pump output.

7. Remove shims (62) from cap (61).

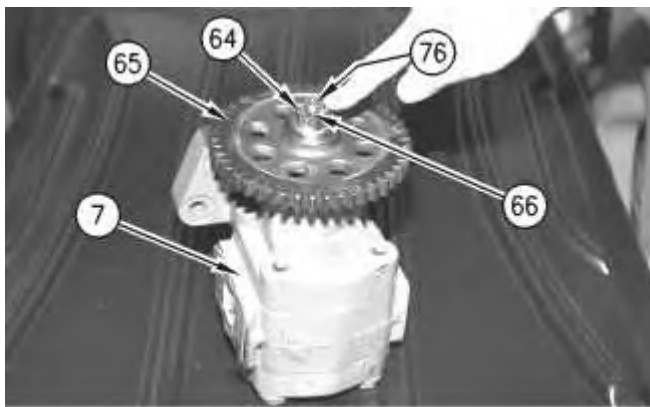

Illustration 9

g00564759

8. Remove cotter pin (66). Remove slotted nut (64) and the washer from gear pump assembly (7). Remove gear (65). Remove key (76) (not shown) from the slot on the gear pump shaft.



Illustration 10

g00572386



Illustration 11

g00572384

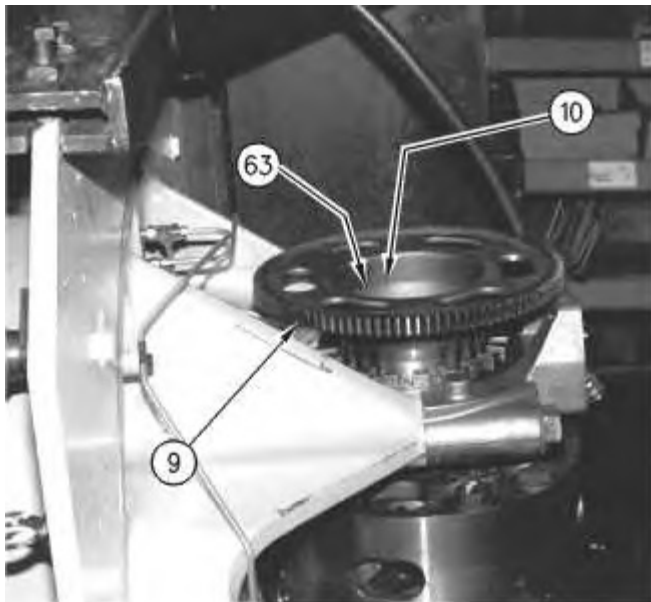

Illustration 12

g00589141

9. Rotate the fixture in order to place gear (9) upward.
  10. Remove 12 socket head bolts (10) and the washers from gear (9).
  11. Remove gear (9) from two dowels (63) (not shown).
-

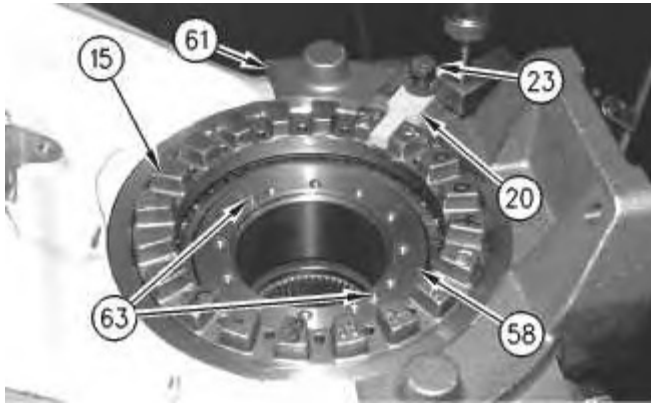

Illustration 13

g00572349

12. Remove bolt (23) and the washer from plate (20).
13. Remove plate (20) from cap (61) and adjusting ring (15).
14. Remove two dowels (63) from differential housing (58).

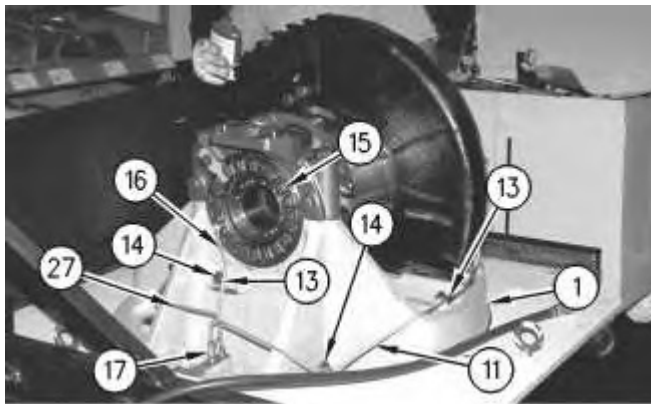
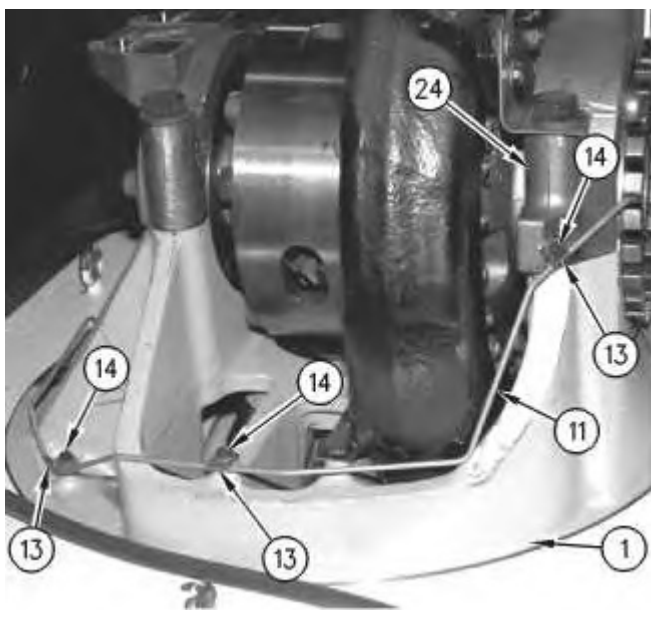

Illustration 14

g00572379



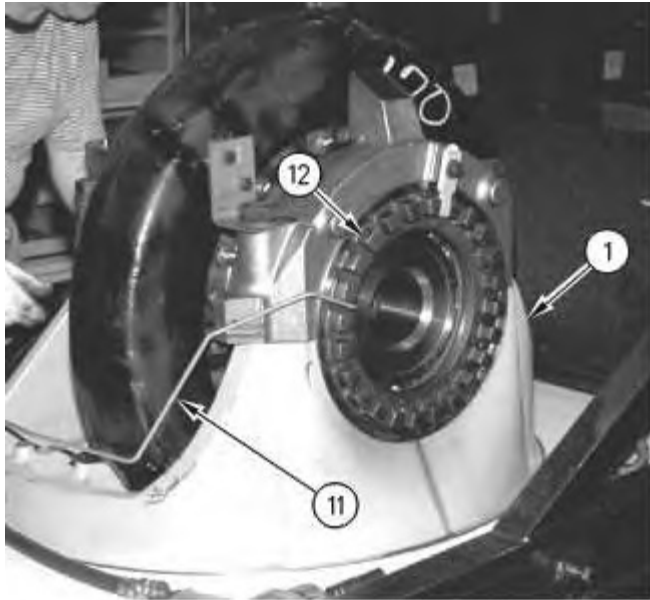

Illustration 16

g00572377

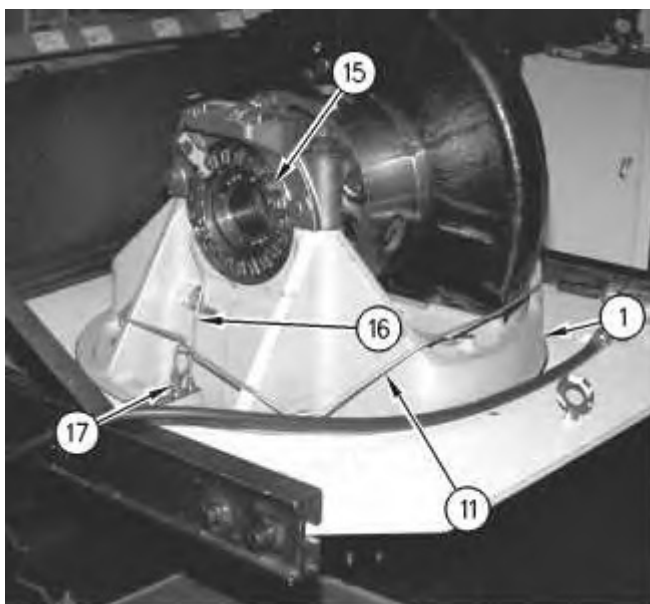

Illustration 17

g00587554

15. Rotate the fixture in order to place differential carrier assembly (1) horizontally.
16. Remove three bolts (14) and the washers from tube assembly (11), differential carrier assembly (1) and cap (24). Remove three clips (13) from tube assembly (11).
17. Remove tube assembly (11) from adjusting ring (12) and tee (17).
18. Remove bolt (14) and the washer from tube assembly (16) and differential carrier assembly (1). Remove clip (13) from tube assembly (16).

19. Remove tube assembly (16) from adjusting ring (15) and tee (17).

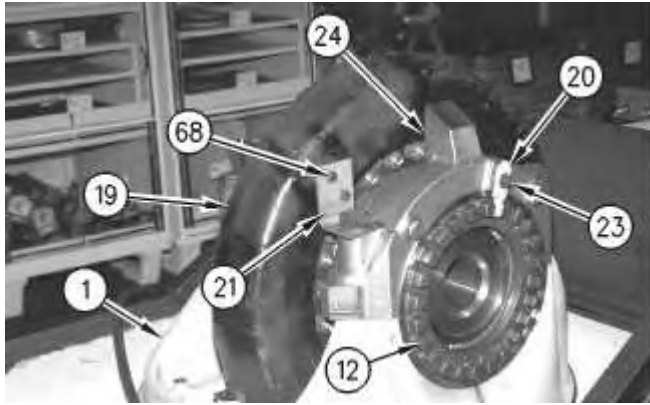

Illustration 18

g00587555



Illustration 19

g00572375

20. Remove two bolts (68) from bracket (21). Remove bolt (68) from gear shroud assembly (19). Remove gear shroud assembly (19) from differential carrier assembly (1).
21. Remove bolt (23) and the washer from plate (20). Remove plate (20) from cap (24) and adjusting ring (12).
-

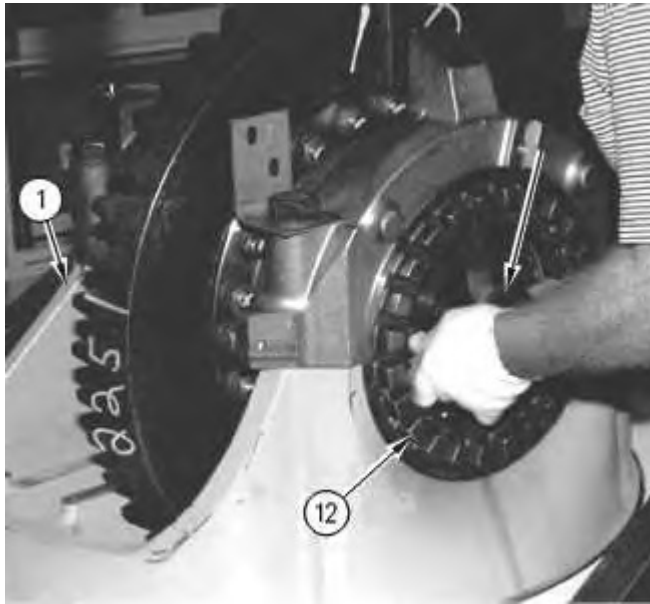

Illustration 20

g00587560

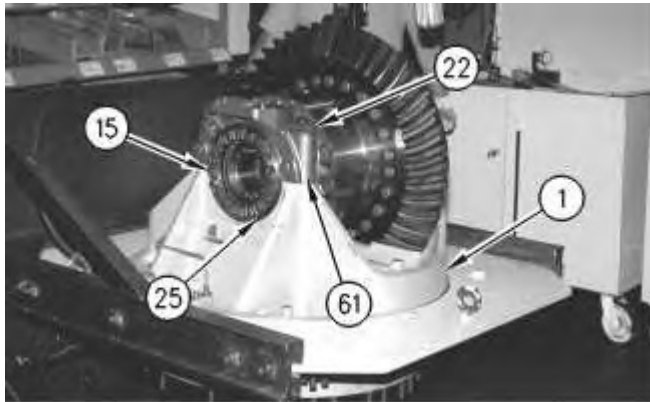

Illustration 21

g00572342

22. Loosen adjusting ring (12) with Tooling (B) (not shown).

**Note:** The arrow designates the tool that is used in the factory.

23. Loosen adjusting ring (15) with Tooling (A) (not shown).

24. Remove two bolts (22) and the washers from cap (61).

25. Remove cap (61) from bearing cage assembly (25) and differential carrier assembly (1).

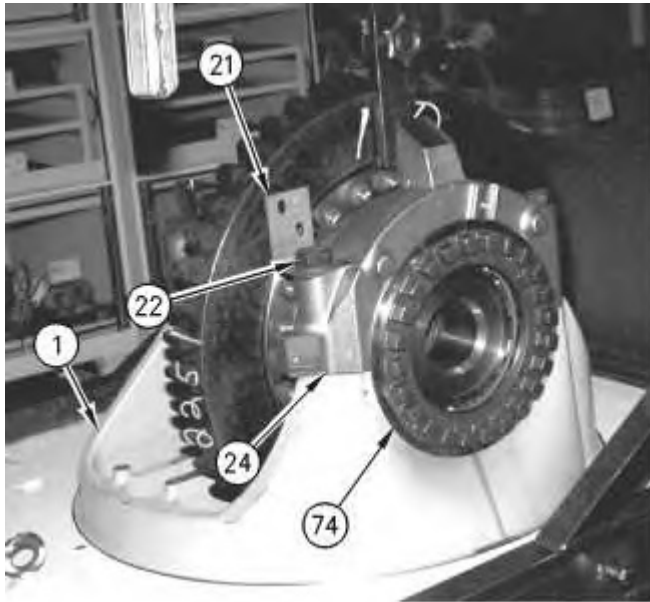

Illustration 22

g00587561

26. Remove two bolts (22) and the washers from cap (24). Remove bracket (21).
27. Remove cap (24) from bearing cage assembly (74) and differential carrier assembly (1).

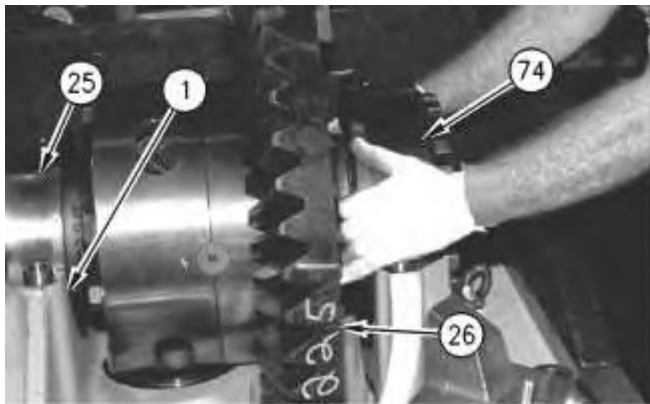

Illustration 23

g00589146

28. Use a suitable hoist in order to remove differential assembly (26) from differential carrier assembly (1), as shown. The weight of differential assembly (26) is 334 kg (736 lb).
29. Remove bearing cage assembly (74) from differential assembly (26) and differential carrier assembly (1). Place bearing cage assembly (74) on a table.
30. Remove bearing cage assembly (25) from differential assembly (26) and differential carrier assembly (1). Place bearing cage assembly (25) on a table.
31. Place differential assembly (26) in a fixture.

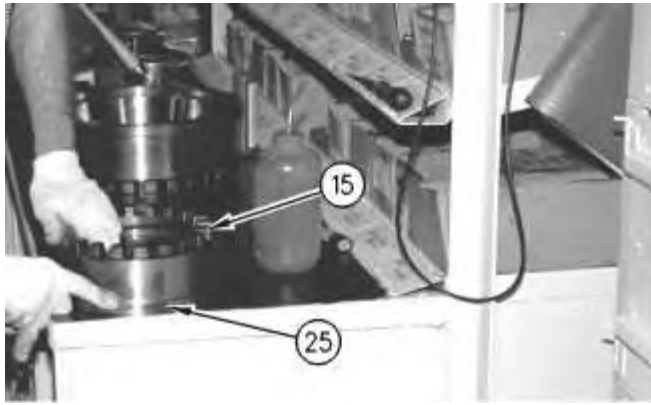

Illustration 24

g00571772

32. Remove adjusting ring (15) from bearing cage assembly (25).

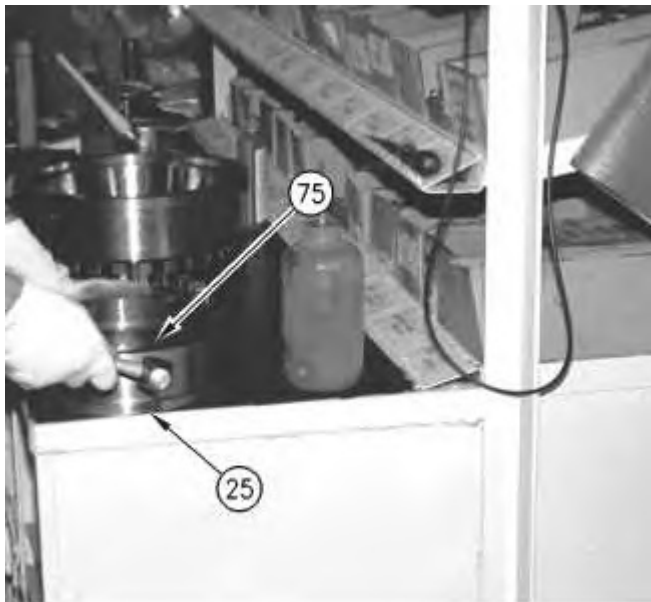

Illustration 25

g00571771

33. Use Tooling (E) (not shown) in order to remove roller bearing cup (75) from bearing cage assembly (25).



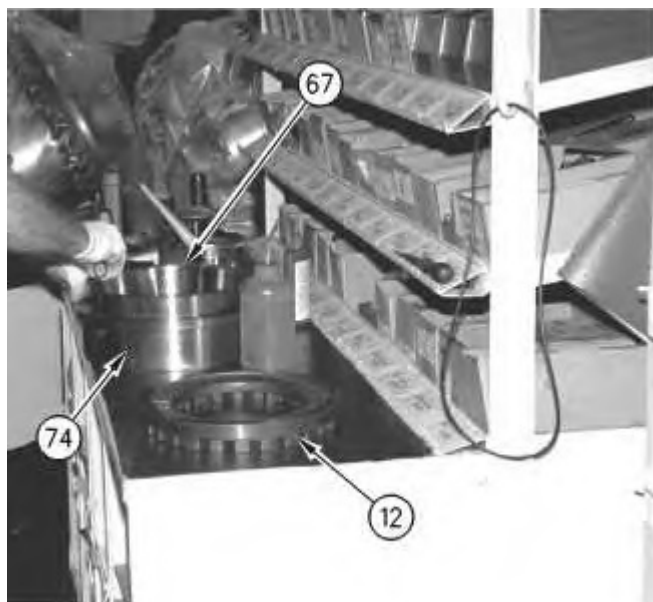

Illustration 27

34. Remove adjusting ring (12) from bearing cage assembly (74).
35. Use Tooling (E) (not shown) in order to remove roller bearing cup (67) from bearing cage assembly (74).

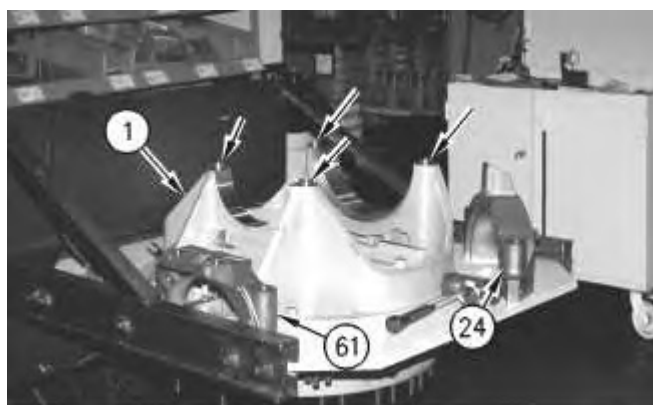

Illustration 28

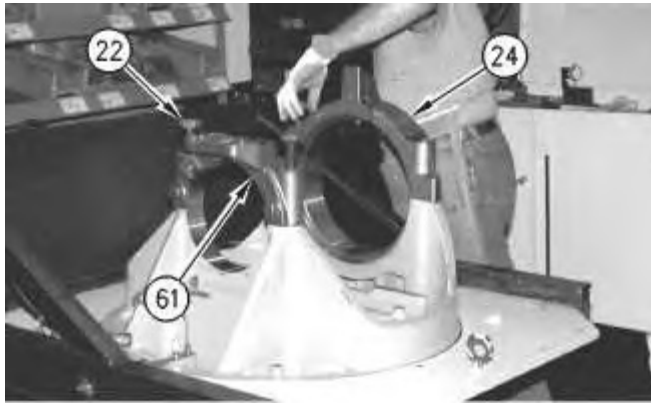

Illustration 29

g00571765

36. Replace cap (61) and cap (24) on differential carrier assembly (1).

**Note:** The arrows designate bushings for installation of cap (24) and cap (61). Replace damaged bushings.

37. Replace four bolts (22) and the washers.

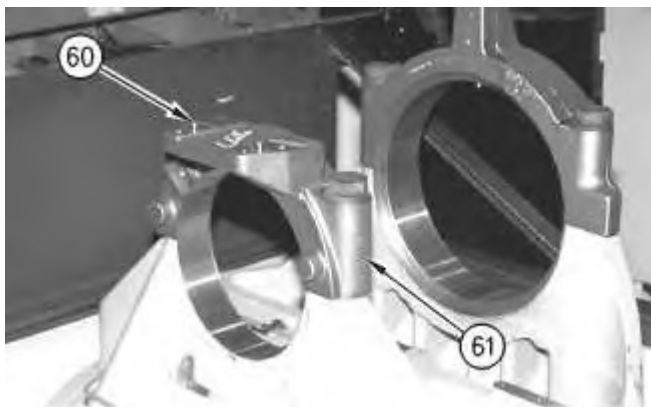

Illustration 30

g00571764

38. Remove two dowels (60) from cap (61).

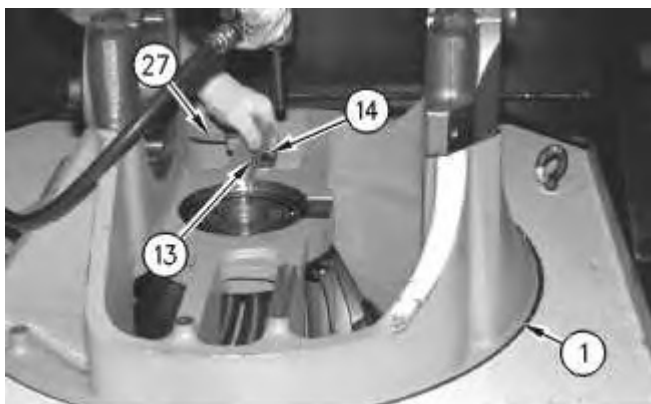
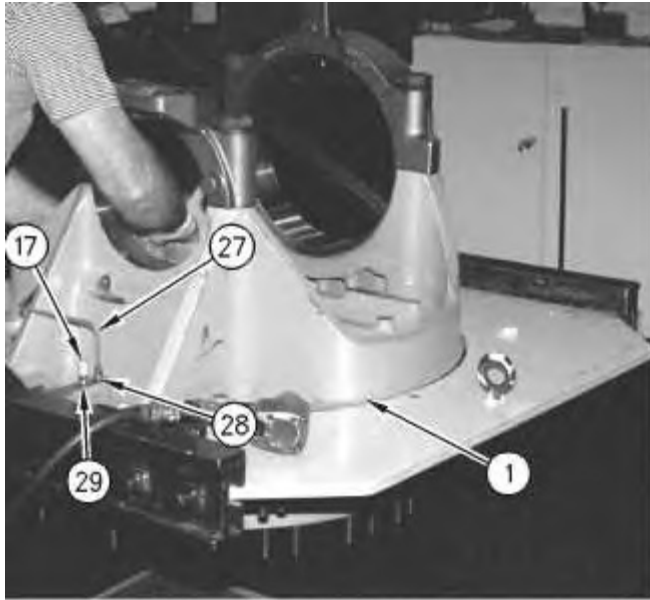

Illustration 31

g00571763



---

Illustration 32

g00571762

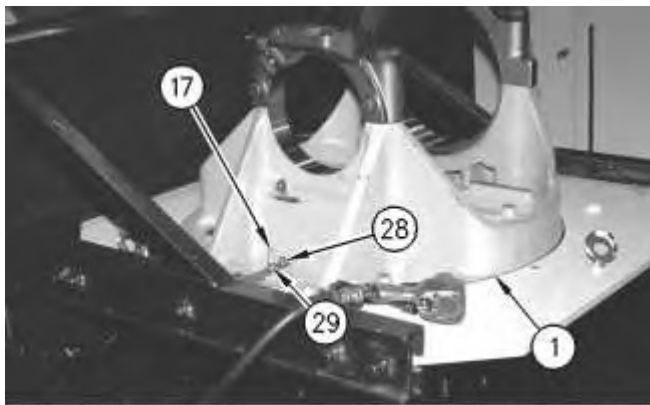

---

Illustration 33

g00571761

39. Remove two bolts (14) and the washers from tube assembly (27) and differential carrier assembly (1). Remove two clips (13) from tube assembly (27).
  40. Remove tube assembly (27) from connector (28).
  41. Remove tee (17) from terminal bushing (29).
-

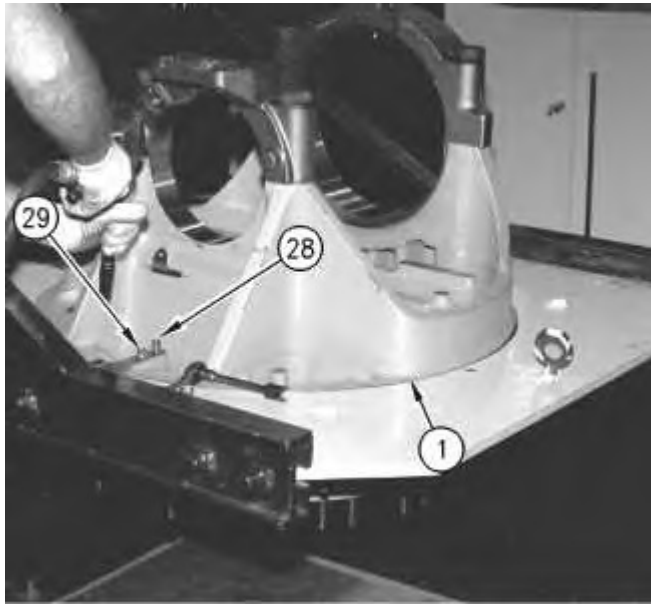

Illustration 34

g00571760

42. Remove terminal bushing (29) from differential carrier assembly (1). Remove connector (28) from differential carrier assembly (1).
43. Rotate the fixture that is holding differential carrier assembly (1).

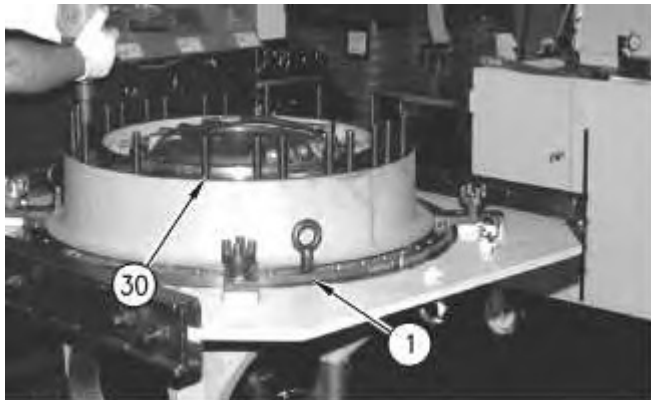
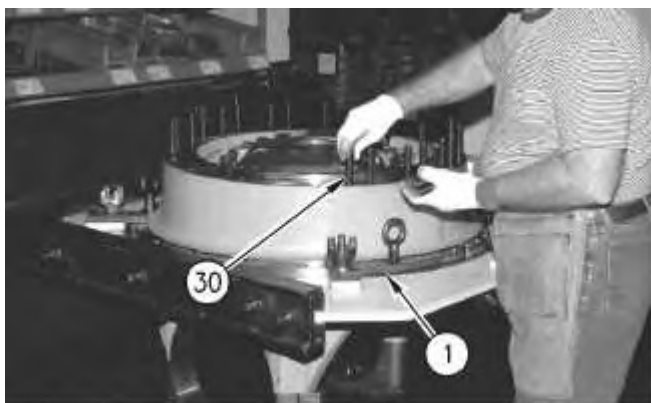

Illustration 35

g00571758



44. Remove 24 taperlock studs (30) from differential carrier assembly (1).

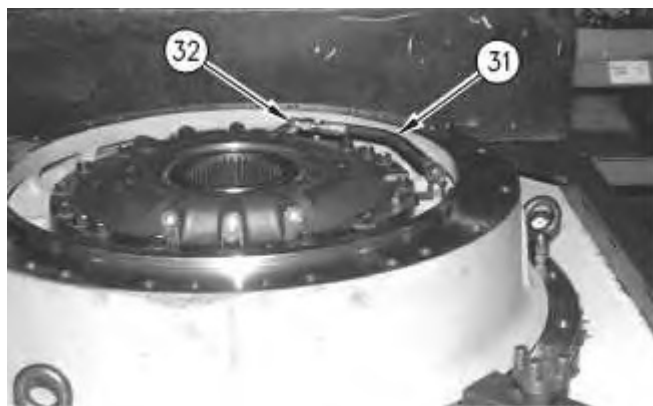

Illustration 37

45. Disconnect hose assembly (31) from elbow (32).



Illustration 38

46. Remove 18 bolts (33) and the washers from bearing cage assembly (34) and differential carrier assembly (1).



Illustration 39

47. Install lifting eyebolts in bearing cage assembly (34).
48. Use a suitable hoist in order to remove bearing cage assembly (34). The weight of bearing cage assembly (34) is 57 kg (125 lb).

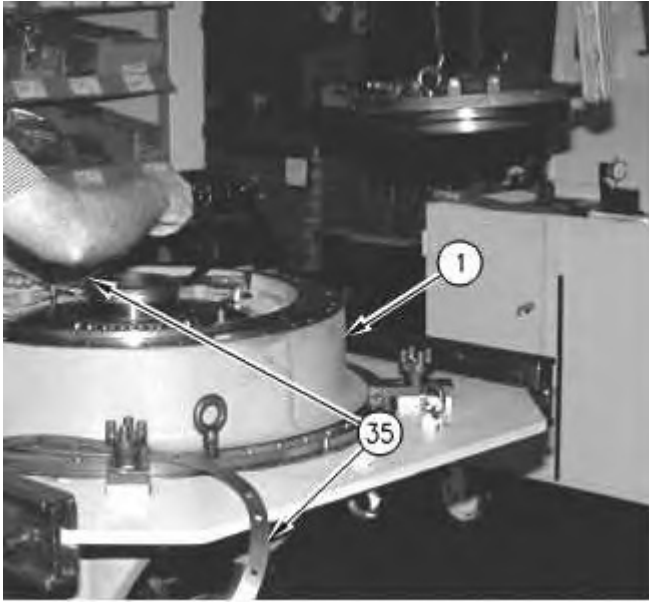

Illustration 40

g00587940

49. Remove shims (35) from differential carrier assembly (1).

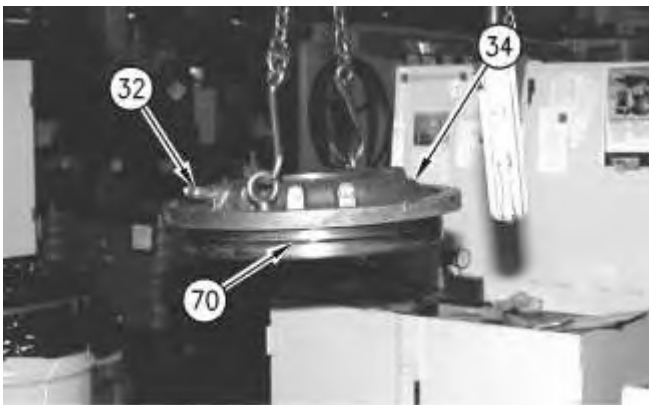

Illustration 41

g00571721

---



Illustration 42

g00571719

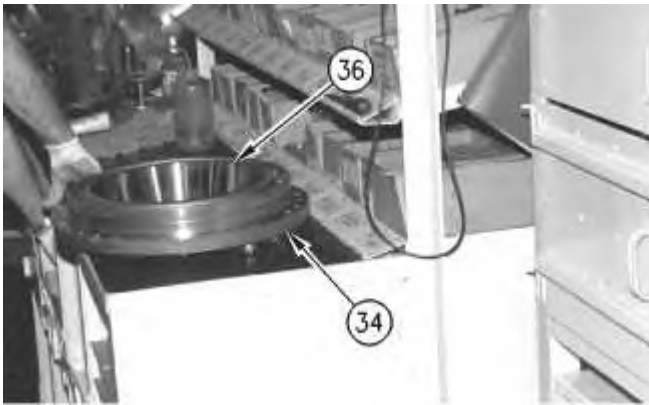

Illustration 43

g00571717

50. Remove elbow (32) from bearing cage assembly (34). Remove the seal on elbow (32).
51. Remove O-ring seal (70) from bearing cage assembly (34).
52. Use a suitable driver in order to remove seal assembly (69) from bearing cage assembly (34).
53. Use Tooling (E) (not shown) in order to remove roller bearing cup (36) from bearing cage assembly (34).

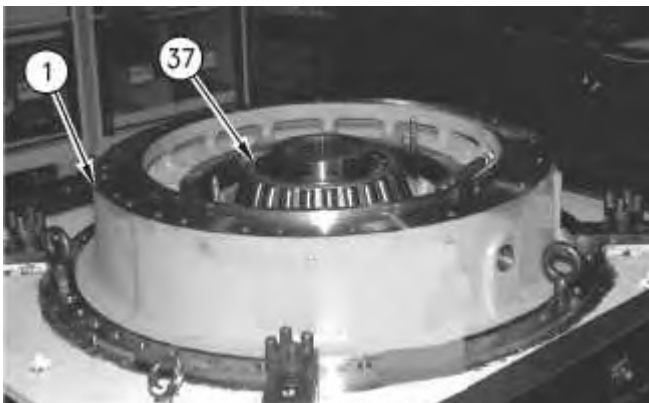

Illustration 44

g00571705



**Suggest:**

**For more complete manuals. Please go to the home page.**

**<https://www.ebooklibonline.com>**

**If the above button click is invalid. Please download this document first, and then click the above link to download the complete manual.**

**Thank you so much for reading**

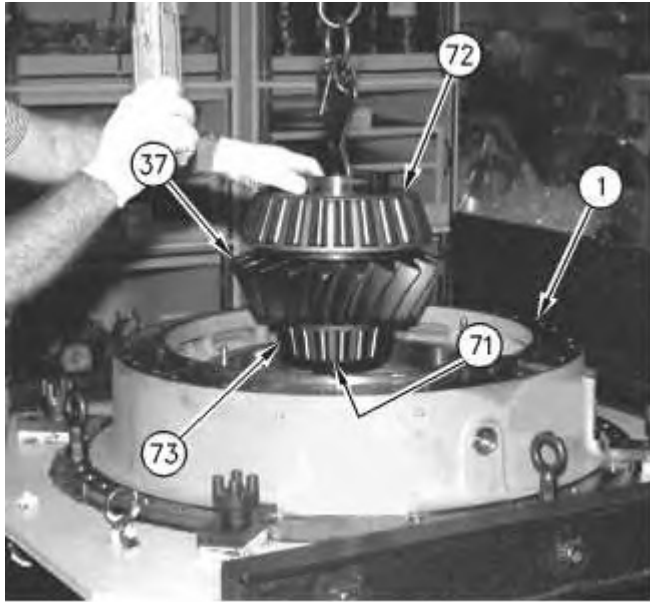

Illustration 45

g00571704

54. Use a suitable hoist in order to remove roller bearing cones and pinion assembly (37) as a complete unit from differential carrier assembly (1). The weight of roller bearing cones and pinion assembly (37) as a complete unit is 86 kg (190 lb).
55. Use Tooling (E) (not shown) in order to remove roller bearing cone (72) and roller bearing cone (73) from pinion assembly (37).
56. Remove cup plug (71) (not shown) from pinion assembly (37).

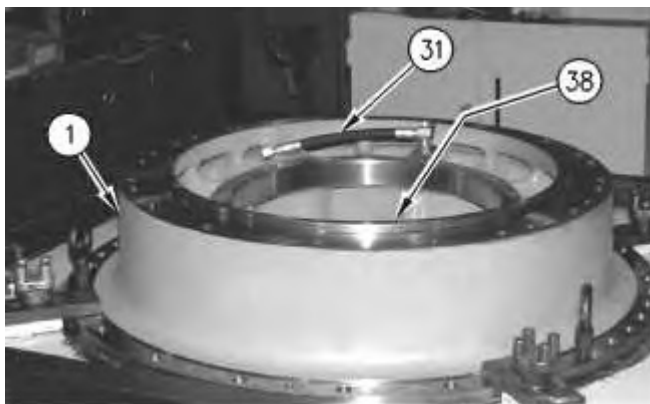

Illustration 46

g00588024

57. Use Tooling (D) (not shown) and a suitable press in order to remove roller bearing cup (38) (not shown) from differential carrier assembly (1).
  58. Remove hose assembly (31) from differential carrier assembly (1).
-



Illustration 47

g00571759

59. Remove two dowels (59) from differential carrier assembly (1).

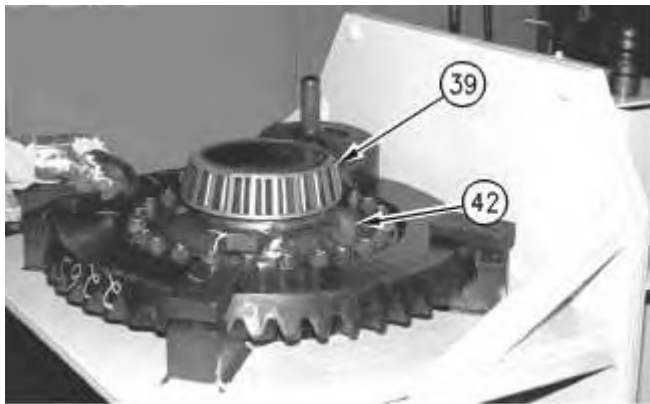

Illustration 48

g00588697

60. Use Tooling (E) (not shown) in order to remove roller bearing cone (39) from differential housing (42).
61. Rotate the fixture that is holding differential housing (42).

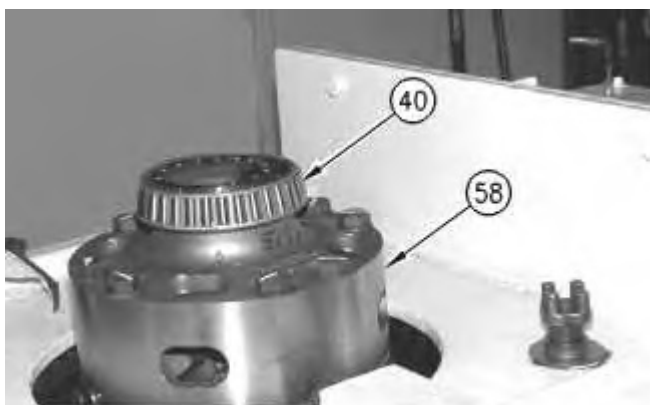

Illustration 49

g00588687

**<https://www.ebooklibonline.com>**

Hello dear friend!

Thank you very much for reading.

Enter the link into your browser.

The full manual is available for immediate download.

**<https://www.ebooklibonline.com>**