

Product: TRUCK

Model: 785D TRUCK MSY

Configuration: 785D Off-Highway Truck MSY00001-UP (MACHINE) POWERED BY 3512C Engine

## Disassembly and Assembly 3512C Engine for Caterpillar Built Machines

Media Number -KENR8117-03

Publication Date -01/09/2018

Date Updated -14/09/2018

i03725502

# Camshaft Bearings - Install

SMCS - 1211-012

## Installation Procedure

Table 1

Required Tool			
Tool	Part Number	Part Description	Qty
A	6V-4077	Camshaft Bearing Tool	1
	125-2739 <sup>(1)</sup>	Bearing Pilot	1
	125-2740 <sup>(1)</sup>	Back Up Plate	1
	125-2741 <sup>(1)</sup>	Bearing Sleeve	1
B	8S-2241	Camshaft Bearing Tool Group	1
C	5P-5247	Hydraulic Puller	1
D	8H-0684	Ratchet Wrench	1

<sup>(1)</sup> Alternate Tooling for camshaft bearings with a large diameter

---

### NOTICE

**Keep all parts clean from contaminants.**

**Contaminants may cause rapid wear and shortened component life.**

---

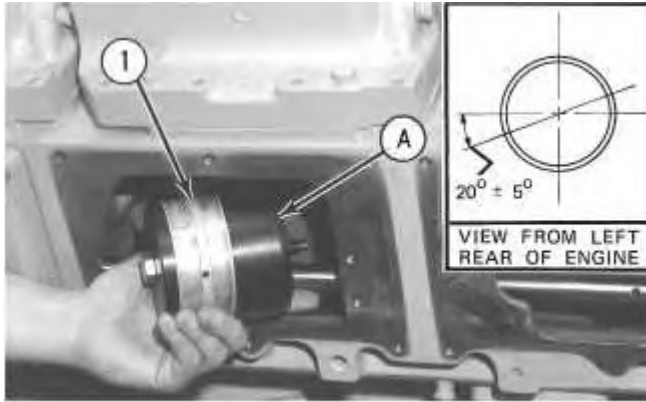

Illustration 1

g00578338

1. Install camshaft bearing (1) on Tooling (A) .

**Note:** Tooling (B) can be used to install the camshaft bearings when the flywheel housing and the front housing have been removed.

2. Position camshaft bearing (1) and Tooling (A) in the bore.

**Note:** The joint in camshaft bearing (1) must be on the horizontal centerline of the bore. The upper oil hole must be  $20 \pm 5$  degrees above the horizontal centerline of the bore. The lower oil hole of camshaft bearing (1) should be  $20 \pm 5$  degrees below the horizontal centerline of the bore. The joints of camshaft bearing (1) on the right side of the engine must face the inside of the cylinder block. The joints of camshaft bearing (1) on the left side of the engine must face the outside of the cylinder block.

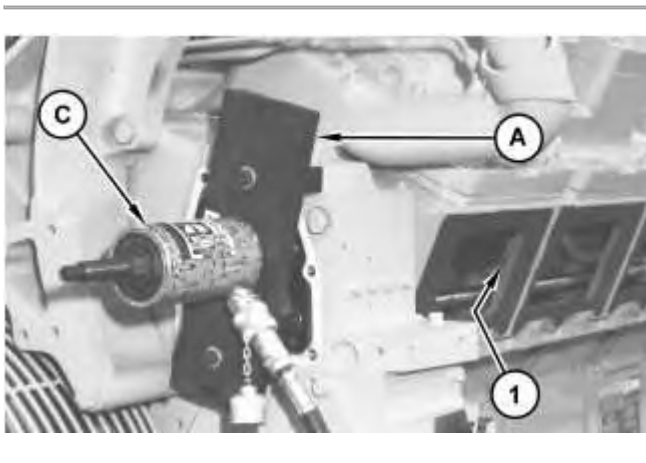

Illustration 2

g01208939

3. Install Tooling (C) on Tooling (A) and pull camshaft bearing (1) (not shown) into the bore.

**Note:** Tooling (D) can be used in place of Tooling (C) .

4. After camshaft bearing (1) (not shown) is installed, measure the bore. The bore must be  $92.00 \pm 0.06$  mm ( $3.620 \pm 0.002$  inch).

**End By:** Install the camshafts. Refer to Disassembly and Assembly, "Camshaft - Install".

Product: TRUCK

Model: 785D TRUCK MSY

Configuration: 785D Off-Highway Truck MSY00001-UP (MACHINE) POWERED BY 3512C Engine

## Disassembly and Assembly 3512C Engine for Caterpillar Built Machines

Media Number -KENR8117-03

Publication Date -01/09/2018

Date Updated -14/09/2018

i04400141

### Camshaft - Install

SMCS - 1210-012

### Installation Procedure

Table 1

Required Tools			
Tool	Part Number	Part Description	Qty
A	238-9586	Camshaft Drive Group	1
C	125-0200	Camshaft Pilot As	2
D	125-0201	Camshaft Guide As	1
E	8T-3169	Crank As	1

---

#### NOTICE

**Keep all parts clean from contaminants.**

**Contaminants may cause rapid wear and shortened component life.**

---

1. **The following steps are for the installation of a camshaft in the 3512C Engines.** The camshaft is in two pieces.

**Note:** Ensure that the camshafts are assembled and installed according to the marks on the ends of the camshafts.

---

**<https://www.ebooklibonline.com>**

Hello dear friend!

Thank you very much for reading.

Enter the link into your browser.

The full manual is available for immediate download.

**<https://www.ebooklibonline.com>**

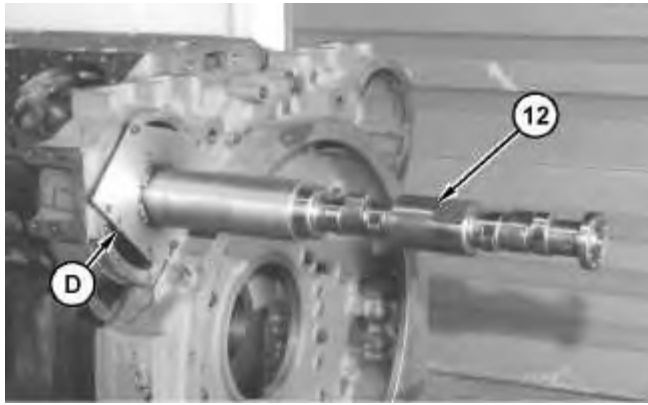

Illustration 1

g01053512

- a. Install Tooling (D) on the flywheel housing. Do not tighten the bolts on Tooling (D).
- b. Install Tooling (C) on the end of the front half of the camshaft.
- c. Ensure that the camshaft and the camshaft bearings are clean. Place clean engine oil on the lobes and the journals of the camshaft. Also place clean engine oil on the camshaft bearings.
- d. Attach a suitable lifting device to the camshaft. The weight of one-half of the camshaft for 3512C Engines is approximately 36 kg (80 lb).
- e. Position the front half of camshaft (12) in the engine until Tooling (C) is in the first camshaft bearing.
- f. Rotate camshaft (12) and tighten the bolts for Tooling (D).
- g. Rotate camshaft (12) and insert the camshaft until the camshaft is slightly protruding from Tooling (D).

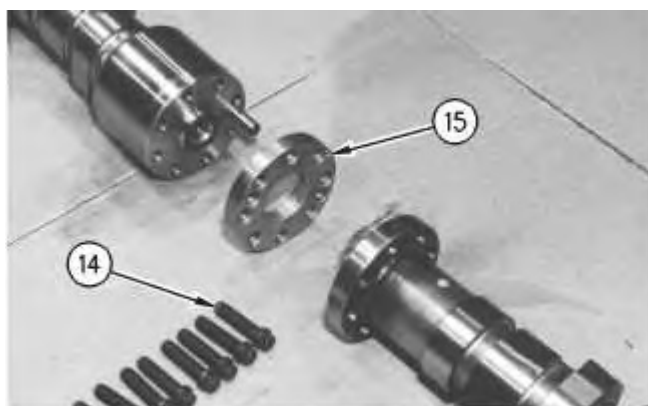

Illustration 2

g00914670

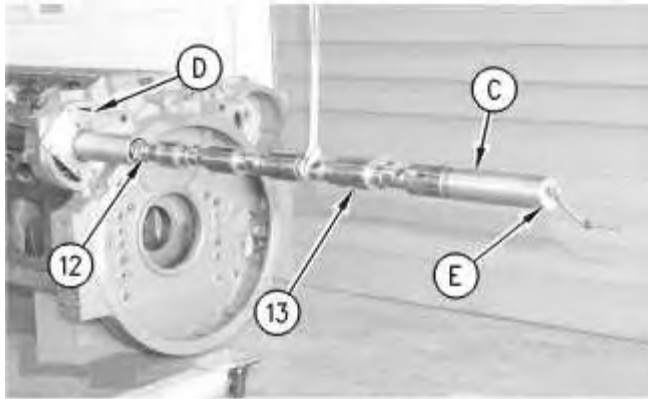

Illustration 3

g00914462

- h. If the dowel was removed from the front half of camshaft (12), install the dowel. Install the dowel to  $22 \pm 0.5$  mm ( $0.9 \pm 0.02$  inch) from the surface of the camshaft.
- i. Attach a suitable lifting device to rear half of camshaft (13). The weight of one-half of the camshaft for 3512C Engines is approximately 36 kg (80 lb). Install spacer (15) and the rear half of camshaft (13) onto the front half of camshaft (12). Install bolts (14) and tighten to a torque of  $55 \pm 7$  N·m ( $41 \pm 5$  lb ft).
- j. Install Tooling (C) and Tooling (E) on the rear half of camshaft (13).
- k. Rotate the rear half of camshaft (13) and insert the camshaft into the engine.
- l. Remove all Tooling. Repeat Steps 1.a through 1.k for the camshaft on the opposite side of the engine.

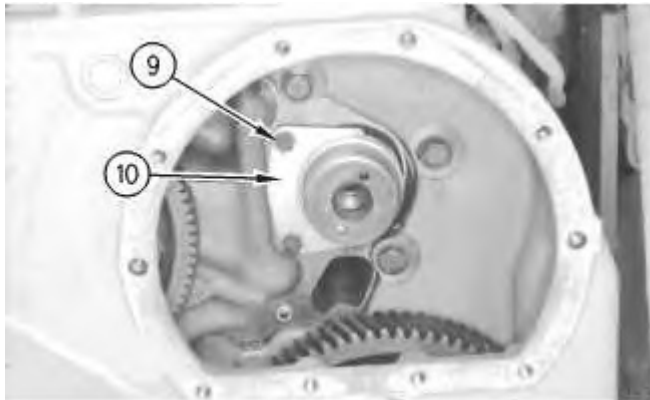

Illustration 4

g00914691

2. Install thrust washers (10) and bolts (9) that fasten the camshaft to the engine.

---

## NOTICE

**If the camshaft is out of time more than 18 degrees (approximately 1/2 of the timing pin is out of the groove), the valves can make contact with**

**the pistons. This will cause damage to the engine. Refer to Testing and Adjusting, "Camshaft Timing" for more information.**

---

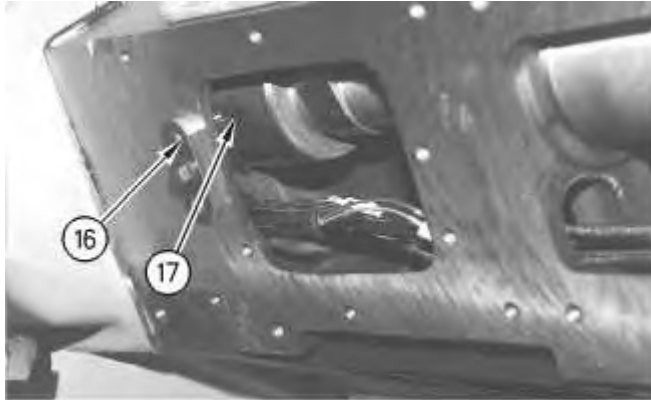

Illustration 5

g00914693

3. Remove timing pin (16) from the storage position on the side of the engine.
4. Turn the camshaft until timing pin (16) can be installed through the cylinder block and into groove (17) that is in the camshaft.
5. Repeat Steps 3 and 4 for the camshaft on the opposite side of the engine.

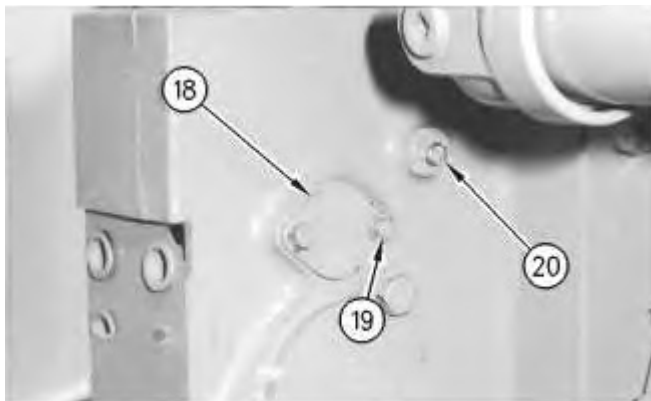

Illustration 6

g00914707

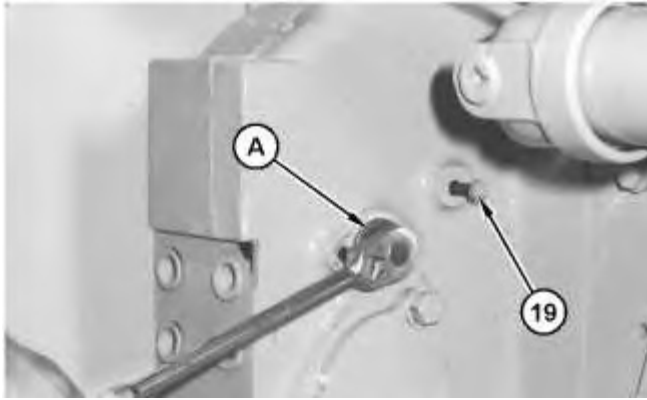

Illustration 7

g01053668

6. Remove bolts (19), cover (18), and plug (20).
7. Install one bolt (19) into the flywheel housing through the hole for plug (20). Use Tooling (A) and a ratchet to turn the flywheel until bolt (19) can be installed through the hole and into the flywheel. Doing so will position the No. 1 cylinder at the top center. Refer to Testing and Adjusting, "Finding the Top Center Position for the No. 1 Piston" for more information.



Illustration 8

g00914726

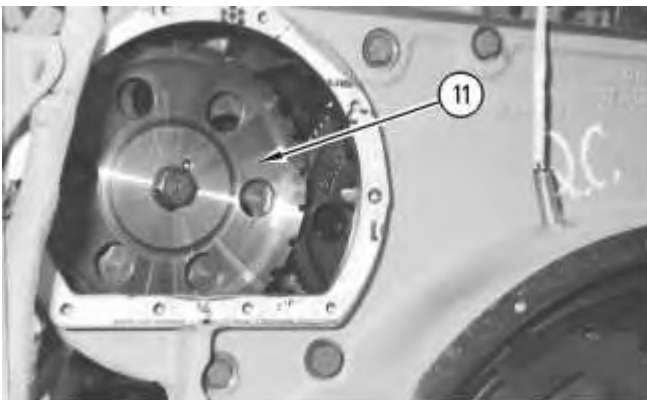

Illustration 9

g00914728

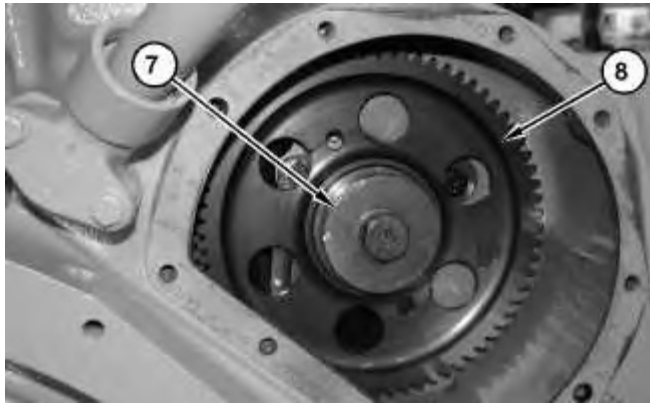

Illustration 10

g01053357

8. Use the following procedure in order to install camshaft drive gears (8).

- a. Clean the taper of the camshaft and the tapered bore of the camshaft gear with a lint free cloth saturated with solvent to remove oil. Clean the parts again with a lint free alcohol wipe in order to remove any residue. The alcohol wipe will dirty after cleaning the parts. Clean the parts again with a lint free alcohol wipe until no residue is left on the alcohol wipe.

**Note:** The taper of the camshaft and the tapered bore of the camshaft gear must be clean, dry, and free of residue before assembly.

- b. Ensure that the camshaft timing pins and the timing pin for the flywheel are installed.
- c. Place camshaft drive gears (8) in position. Remove the backlash by rotating the gears in the opposite direction of camshaft rotation.

**Note:** For "Standard Rotation" engines, turn the camshaft drive gears COUNTERCLOCKWISE. For "Reverse Rotation" engines, turn the camshaft drive gears CLOCKWISE.

- d. Install the bolt and plate (7).
  - e. Install the bolt and timing ring (11). Ensure that the hole in the timing ring is properly seated on the locating pin.
  - f. Tighten the bolt to a torque of 360 N·m (265 lb ft).
  - g. Place a Mark on the bolt.
  - h. Place a driver against the retaining plate of the camshaft gear. Strike the driver solidly with a hammer 3 to 4 times.
  - i. Tighten the bolt again to a torque of 360 N·m (265 lb ft).
  - j. Repeat Steps 8.h and 8.i until the Mark has turned at least 90 degrees.
-

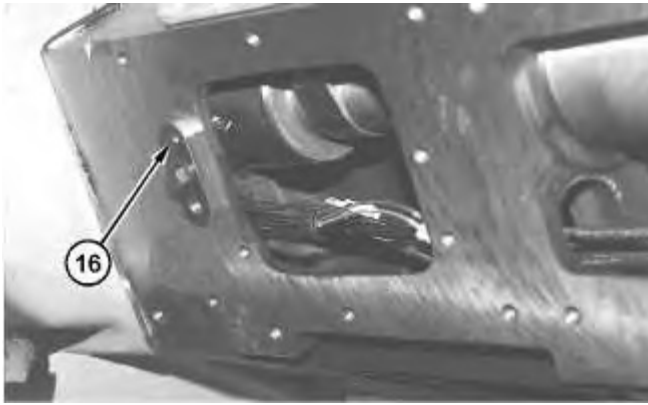

Illustration 11

g01053666

9. Remove the timing pins from the camshafts. Install timing pins (16) in the original locations.

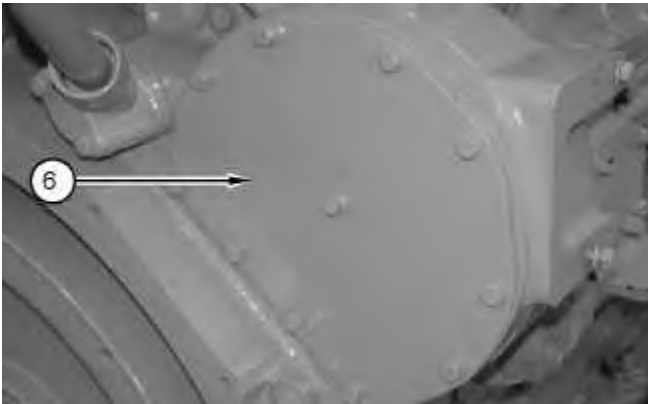

Illustration 12

g01053666

10. Install the gaskets and covers (6) over the camshaft drive gears on both sides of the engine.

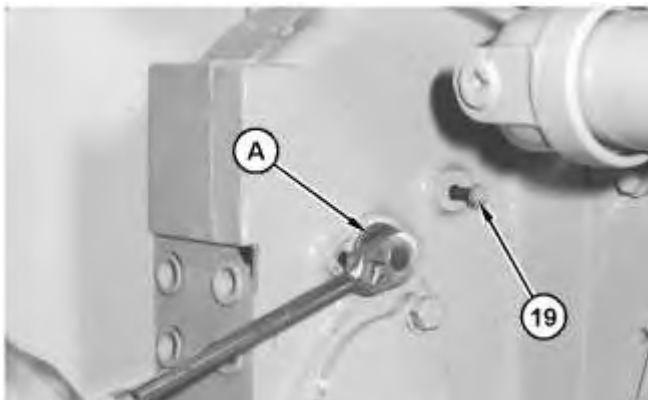

Illustration 13

g01053668

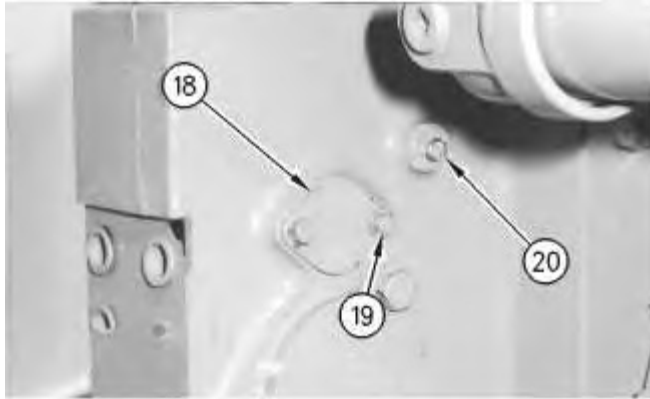

Illustration 14

g00914707

11. Remove bolt (19) from the flywheel. Install plug (20) in the timing hole. Remove Tooling (A) and install cover (18) with bolts (19) on the flywheel housing.

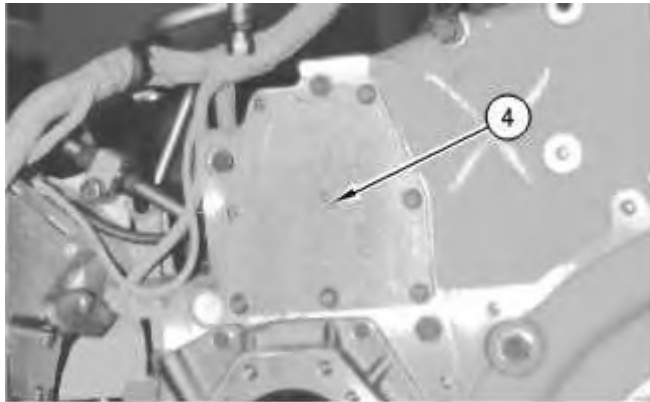

Illustration 15

g00914348

12. Install covers (4) on the front housing.

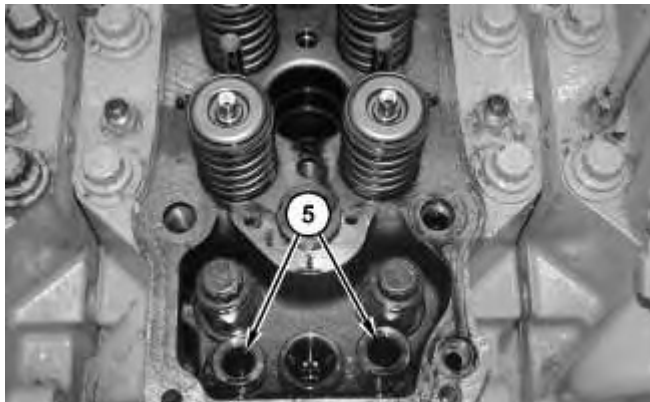
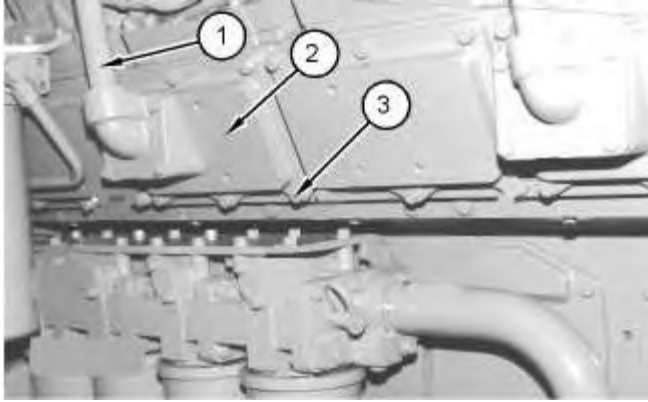

Illustration 16

g01053356

13. Remove the O-ring seals from valve lifters (5). Push valve lifters (5) against the camshaft.



---

Illustration 17

g01007161

14. Position covers (2) and install bolts (3) on both sides of the engine.
15. Install tube assemblies (1).

**End By:**

- a. Install the electronic control module. Refer to Disassembly and Assembly, "Electronic Control Module (Engine) - Remove and Install".
  - b. Install the engine speed/timing sensor. Refer to Disassembly and Assembly, "Engine Speed/Timing Sensor - Remove and Install".
  - c. Install the valve mechanism cover base. Refer to Disassembly and Assembly, "Valve Mechanism Cover Base - Remove and Install".
-

Product: TRUCK

Model: 785D TRUCK MSY

Configuration: 785D Off-Highway Truck MSY00001-UP (MACHINE) POWERED BY 3512C Engine

## Disassembly and Assembly 3512C Engine for Caterpillar Built Machines

Media Number -KENR8117-03

Publication Date -01/09/2018

Date Updated -14/09/2018

i02986618

### Crankshaft - Remove

SMCS - 1202-011

### Removal Procedure

Table 1

Required Tools			
Tool	Part Number	Part Description	Qty
A	4C-9832	Engine Rollover Stand	1
B	138-7576	Link Bracket	2

#### Start By:

- a. Remove the rocker shaft assemblies and the pushrods. Refer to Disassembly and Assembly, "Rocker Shaft and Pushrod - Remove".
- b. Remove the flywheel housing. Refer to Disassembly and Assembly, "Flywheel Housing - Remove".
- c. Remove the front housing. Refer to Disassembly and Assembly, "Housing (Front) - Remove".
- d. Remove the piston cooling jets. Refer to Disassembly and Assembly, "Piston Cooling Jets - Remove and Install".

---

#### NOTICE

**Failure to remove the rocker shaft assemblies and push rods can result in damaged valves when the pistons and connecting rods are pushed away from the crankshaft.**

**To help avoid damage to the valves, remove the rocker shaft assemblies and push rods before you remove the crankshaft.**

---

---

### **NOTICE**

**Keep all parts clean from contaminants.**

**Contaminants may cause rapid wear and shortened component life.**

---

1. Use Tooling (A) to turn the engine to a horizontal position. The engine can be supported with Tooling (A) or with blocks.

- The weight of the 3512C Engine is approximately 6800 kg (15000 lb).

**Note:** It is not necessary to remove the counterweights from the crankshaft, if the piston and connecting rod assemblies have been removed from the engine.

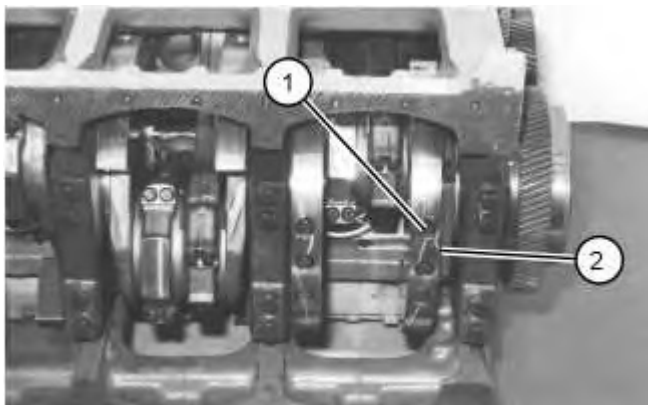

Illustration 1

g01124519

2. Place identification marks on counterweights (2). Remove bolts (1) and counterweights (2) from the crankshaft.

**Note:** Do not reuse bolts (1). Use new bolts in order to secure the counterweight to the crankshaft.

---

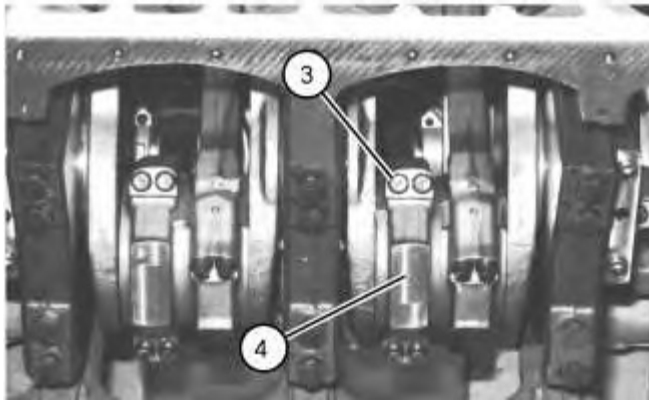

Illustration 2

g01124522

**Note:** Number the connecting rod caps and the connecting rods for installation purposes.

3. Remove bolts (3). Remove connecting rod cap (4) and push the connecting rod away from the crankshaft.

**Note:** Ensure that the journals of the crankshaft are not scratched by the connecting rods.

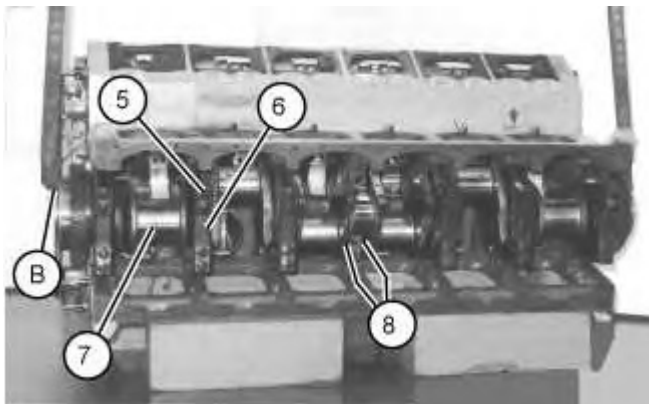
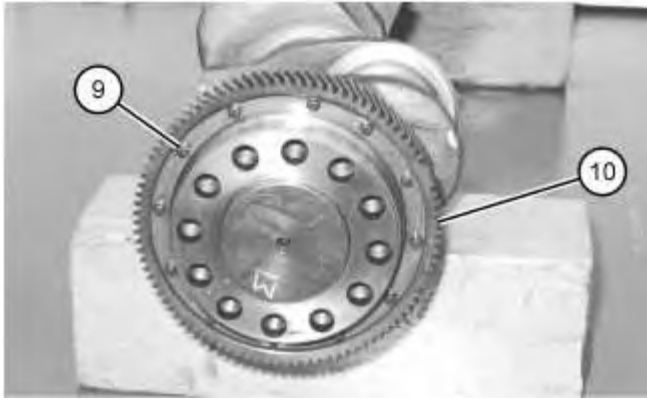

Illustration 3

g01124538

4. Attach Tooling (B) to each end of crankshaft (7). Attach a suitable lifting device to Tooling (B). The weight of the 3512C crankshaft is approximately 600 kg (1325 lb).
5. Remove bolts (5) and main bearing caps (6).
6. Remove thrust plates (8) from each side of the center main bearing.
7. Remove crankshaft (7) from the cylinder block.
8. Remove the upper halves of the main bearings from the cylinder block.
9. Remove the upper halves of the connecting rod bearings from the connecting rods.



---

Illustration 4

g01124543

10. If necessary, remove bolts (9) and crankshaft gear (10) from each end of the crankshaft.
-

Product: TRUCK

Model: 785D TRUCK MSY

Configuration: 785D Off-Highway Truck MSY00001-UP (MACHINE) POWERED BY 3512C Engine

## Disassembly and Assembly 3512C Engine for Caterpillar Built Machines

Media Number -KENR8117-03

Publication Date -01/09/2018

Date Updated -14/09/2018

i05978103

## Crankshaft - Install

SMCS - 1202-012

## Installation Procedure

Table 1

Required Tools			
Tool	Part Number	Part Description	Qty
A	4C-9832	Engine Rollover Stand	1
B	138-7576	Link Bracket	2
C	334-0519	Grease	-
D	8T-5096	Dial Indicator Gp	1

---

### NOTICE

**Keep all parts clean from contaminants.**

**Contaminants may cause rapid wear and shortened component life.**

---

---

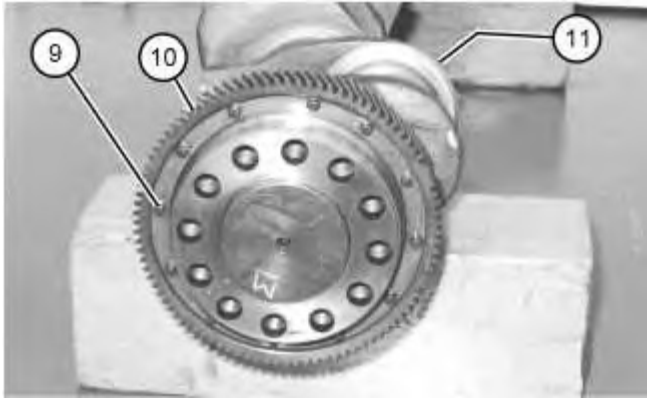

Illustration 1

g01124614

1. Install plugs (11) and tighten to a torque of  $50 \pm 7$  N·m ( $37 \pm 5$  lb ft).
2. Position crankshaft gear (10) on the crankshaft and install bolts (9).

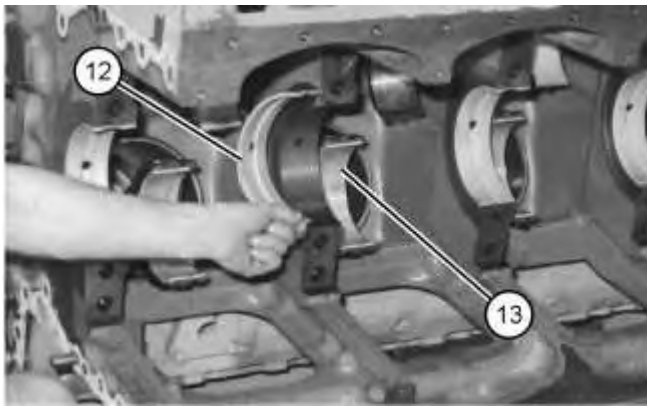

Illustration 2

g01124115

**Note:** Install the main bearings dry when clearance checks are performed. Refer to Disassembly and Assembly, "Bearing Clearance - Check". Apply clean engine oil on the main bearings for final assembly.

3. Install the upper half of main bearing (12) in the cylinder block. Ensure that the main bearing is installed so that the bearing tab fits into the notch in the cylinder block. Coat the main bearing with clean engine oil.

**Note:** The upper half of the main bearing has an oil hole in the center.

4. Install the upper halves of connecting rod bearings (13) in the connecting rod assemblies. Coat the connecting rod bearing with clean engine oil.

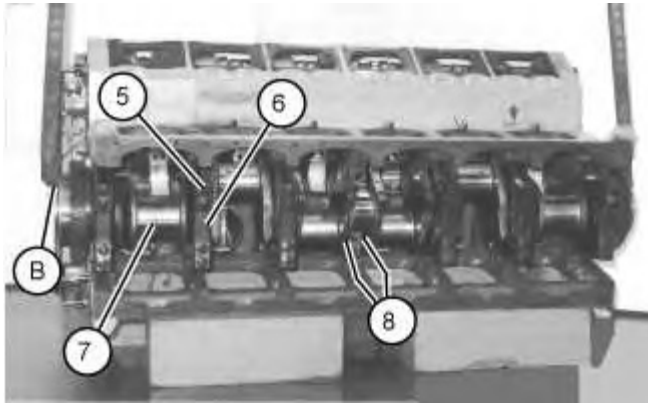

Illustration 3

g01124538

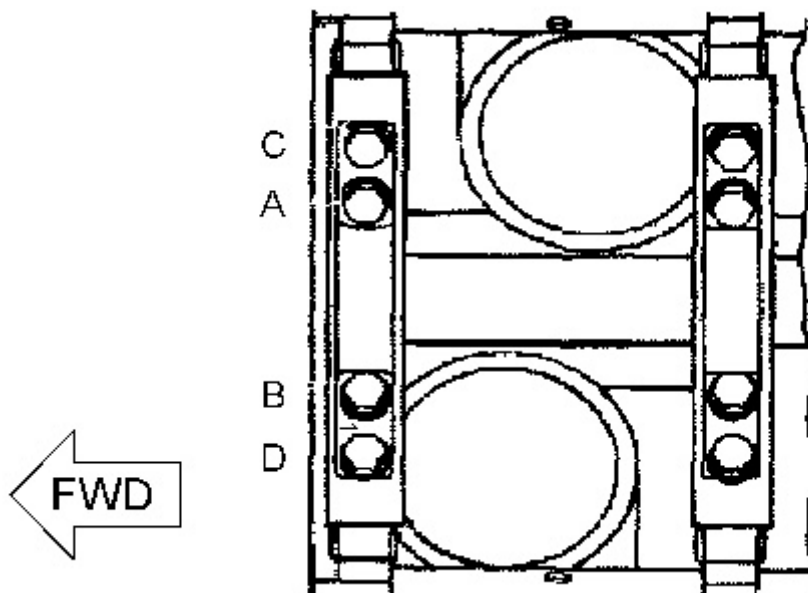

Illustration 4

g01124192

Bolt tightening sequence for the main bearing caps

**Note:** Ensure that the word "FRONT" that is on the end of the crankshaft is toward the front of the engine.

5. Attach Tooling (B) and a suitable lifting device to each end of crankshaft (7). The weight of the 3512C crankshaft is approximately 600 kg (1325 lb). Position the crankshaft in the cylinder block.
6. Place clean engine oil on thrust plates (8). Install thrust plates (8) on each side of the center main bearing.
7. Install the lower half of the main bearing in the main bearing cap. Ensure that the main bearing is installed so that the bearing tab fits into the notch in main bearing cap (6). Coat the main bearing with clean engine oil.
8. Coat the underside of the bolt heads and the threads of bolts (5) with clean engine oil. Position main bearing caps (6) and install the bolts and washers. Do not tighten the bolts at this time.

**Note:** The main bearing caps must be installed with the word "FRONT" and the part number toward the front of the engine. Each main bearing cap has a number on the bottom surface and each main bearing must be installed in the corresponding position in the cylinder block.

9. Tighten bolts (5) in sequence to a torque of  $190 \pm 14 \text{ N}\cdot\text{m}$  ( $140 \pm 10 \text{ lb ft}$ ).
10. Place an index mark on the bolts and the main bearing cap. Tighten the bolts for an additional  $180 \pm 5$  degrees ( $1/2$  turn).
11. Rotate the crankshaft in order to ensure that the crankshaft turns freely.
12. Use Tooling (D) to measure the end play of the crankshaft. The end play must not exceed 0.17 to 0.63 mm (0.007 to 0.025 inch).

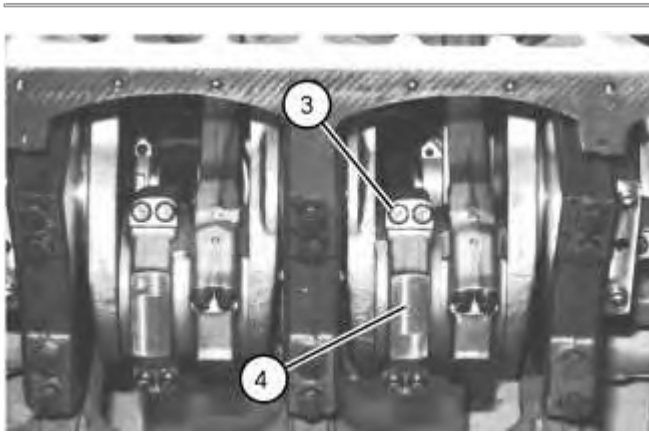

Illustration 5

g01124522

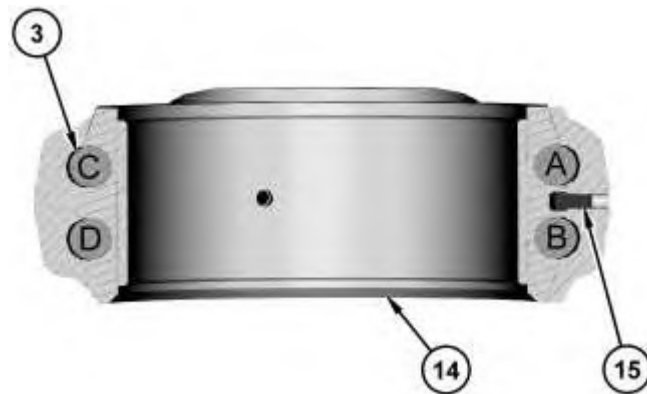

Illustration 6

g03745347

Section view of connecting rod showing torque sequence. Chamfer (9) and dowel (10) can be used to reference orientation.

**Note:** Install the connecting rod bearings dry when clearance checks are performed. Refer to Disassembly and Assembly, "Bearing Clearance - Check". Apply clean engine oil on the connecting rod bearings for final assembly.

13. Install the upper half of the connecting rod bearing on the connecting rod. Ensure that the connecting rod bearing is installed so that the bearing tab fits into the notch in the



**Suggest:**

**For more complete manuals. Please go to the home page.**

**<https://www.ebooklibonline.com>**

**If the above button click is invalid. Please download this document first, and then click the above link to download the complete manual.**

**Thank you so much for reading**

connecting rod. Coat the connecting rod bearing with clean engine oil. Position the connecting rod onto a journal of the crankshaft.

14. Install the lower half of the connecting rod bearing on connecting rod cap (4). Ensure that the connecting rod bearing is installed so that the bearing tab fits into the notch in the connecting rod cap. Coat the connecting rod bearing with clean engine oil.

**Note:** The number that is on the side of the connecting rod caps must be installed next to the corresponding number that is on the side of the connecting rod. Install the chamfered side of the connecting rod cap next to the thrust surface of the crankshaft.

**Note:** Reman connecting rods are not numbered for the cylinder position.

15. Apply Tooling (C) to the threads, the shank, and the seat of bolts (3).
16. Place connecting rod cap (4) into position. Install bolts (3). Use the following procedure to tighten the bolts:
  - a. Tighten Bolt (A) and Bolt (B) to a torque of  $90 \pm 5$  N·m ( $65 \pm 4$  lb ft).
  - b. Tighten Bolt (C) and Bolt (D) to a torque of  $90 \pm 5$  N·m ( $65 \pm 4$  lb ft).
  - c. Tighten Bolt (C) and Bolt (D) again to a torque of  $90 \pm 5$  N·m ( $65 \pm 4$  lb ft).
  - d. Place an index mark on the bolts and the connecting rod cap. Tighten each bolt for an additional  $90 \pm 5$  degrees ( $1/4$  turn).
17. Rotate the crankshaft in order to ensure that the crankshaft turns freely.

---

## NOTICE

**Each counterweight is numbered and must be installed in the same position as the corresponding number on the crankshaft mounting pad in order to prevent damage to the crankshaft.**

---

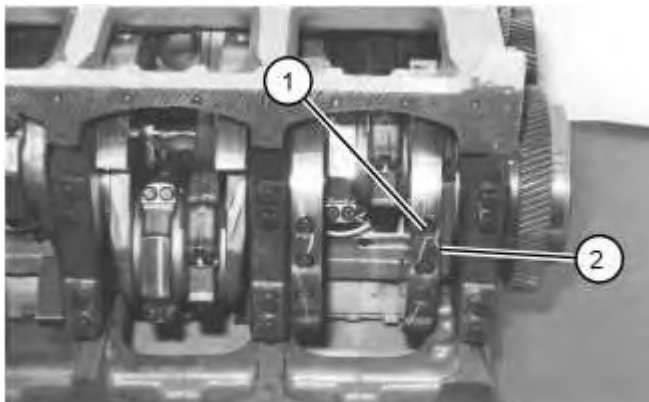

Illustration 7

g01124519

18. Apply Tooling (C) to the threads, the shank, and the seat of bolts (1).

**Note:** Do not reuse bolts (1). Use new bolts in order to secure the counterweight to the crankshaft.

19. Position counterweights (2) in the correct position on the crankshaft and install bolts (1). Tighten the bolts evenly to a torque of  $70 \pm 5$  N·m ( $50 \pm 4$  lb ft).

20. Place an index mark on the bolts and the counterweight. Tighten the bolts for an additional  $120 \pm 5$  degrees (1/3 turn).

21. Use Tooling (A) in order to turn the engine to a vertical position.

- The weight of the 3512C Engine is approximately 6800 kg (15000 lb).

**End By:**

- a. Install the piston cooling jets. Refer to Disassembly and Assembly, "Piston Cooling Jets - Remove and Install".
  - b. Install the front housing. Refer to Disassembly and Assembly, "Housing (Front) - Install".
  - c. Install the flywheel housing. Refer to Disassembly and Assembly, "Flywheel Housing - Install".
  - d. Install the rocker shaft assemblies and the pushrods. Refer to Disassembly and Assembly, "Rocker Shaft and Pushrod - Install".
-

**<https://www.ebooklibonline.com>**

Hello dear friend!

Thank you very much for reading.

Enter the link into your browser.

The full manual is available for immediate download.

**<https://www.ebooklibonline.com>**