

Product: TRUCK

Model: 785C TRUCK APX

Configuration: 785C Off-Highway Truck APX00001-UP (MACHINE) POWERED BY 3512B Engine

Disassembly and Assembly

3500 and 3500B High Displacement Engines for Caterpillar Built Machines

Media Number -SEN1126-33

Publication Date -01/07/2015

Date Updated -14/09/2018

i07201266

Front Drive Housing - Remove and Install

SMCS - 1151-010

Removal Procedure

Table 1

Required Tools			
Tool	Part Number	Part Description	Qty
A	1P-0074	Slide Hammer Puller	1
	8B-7557	Threaded Adapter	1
B	138-7573	Link Bracket	2
C	1P-0520	Driver Group	1
D	-	Guide Bolt 5/8x11 NC	2

Start By:

- Remove the oil filter base. Refer to Disassembly and Assembly, "Engine Oil Filter Base - Remove".
- Remove the crankshaft front seal and the wear sleeve. Refer to Disassembly and Assembly, "Crankshaft Front Seal and Wear Sleeve - Remove".
- Remove the accessory drive (front). Refer to Disassembly and Assembly, "Accessory Drive (Front) - Remove".
- Remove the engine oil and water pump drive. Refer to Disassembly and Assembly, "Engine Oil and Water Pump Drive - Remove".

- e. Remove the auxiliary water pump. Refer to Disassembly and Assembly, "Auxiliary Water Pump - Remove".

NOTICE

Keep all parts clean from contaminants.

Contaminants may cause rapid wear and shortened component life.

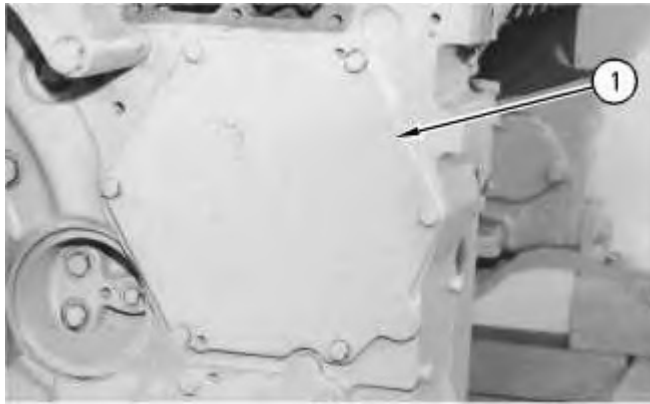

Illustration 1

g00907030

1. Remove cover (1) and the O-ring seal.

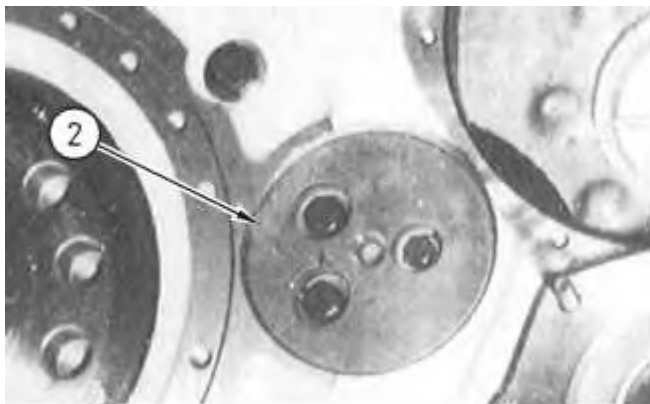

Illustration 2

g00907040

2. Remove the bolts that hold shaft (2) in the front drive housing. Use Tooling (A) to remove shaft (2). Remove the O-ring seal from shaft (2).
-

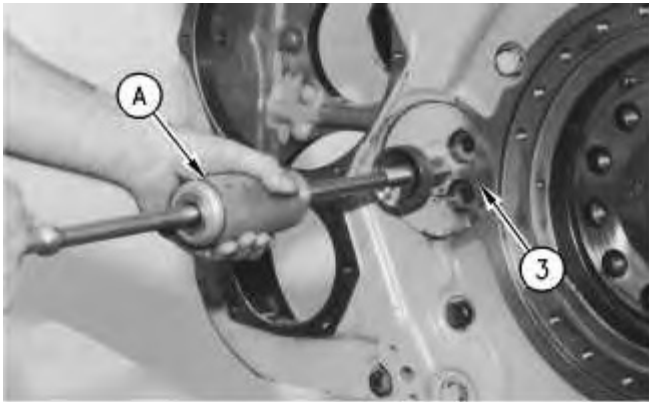

Illustration 3

g00907098

3. Remove the bolts that hold shaft (3) in the front drive housing. Use Tooling (A) to remove shaft (3), the idler gear, and the washer. Remove the O-ring seal from shaft (3).
4. Use Tooling (C) and a suitable press to remove the bearing from the idler gear, if necessary.



Illustration 4

g00907145

5. Install Tooling (B) and attach a suitable lifting device to front drive housing (4). The weight of front drive housing (4) is approximately 209 kg (460 lb). Remove two bolts and install Tooling (D). Remove the rest of the bolts that hold front drive housing (4) to the cylinder block. Remove front drive housing (4) and the gasket.

Installation Procedure

Table 2

Required Tools			
Tool	Part Number	Part Description	Qty
B	138-7573	Link Bracket	2
C	1P-0520	Driver Group	1
D	-	Guide Bolt (5/8x11 NC)	2
F	-	Loctite Flange Sealant 5900	-

<https://www.ebooklibonline.com>

Hello dear friend!

Thank you very much for reading.

Enter the link into your browser.

The full manual is available for immediate download.

<https://www.ebooklibonline.com>

NOTICE

Keep all parts clean from contaminants.

Contaminants may cause rapid wear and shortened component life.

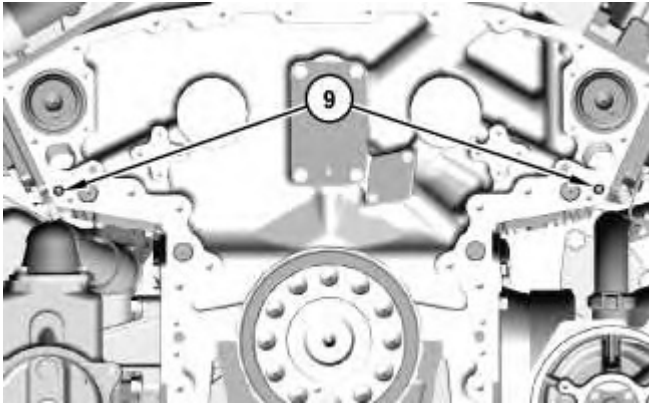

Illustration 5

g03896709

1. Install O-ring seals (9) on the dowel.

Note: If the dowels need to be replaced, the installed height is 6.0 ± 0.5 mm (0.24 ± 0.02 inch).

2. Install the gasket for the front drive housing onto the cylinder block. Apply Tooling (F) to both sides of all the gasket joints immediately prior to installation of front drive housing (4). Install Tooling (D) into the cylinder block.

Note: Tooling (F) should span the entire abutment of the gasket joints and be worked into any gaps.



Illustration 6

g00907145

3. Install Tooling (B) and attach a suitable lifting device to front drive housing (4). The weight of front drive housing (4) is approximately 209 kg (460 lb). Position front drive housing (4) onto Tooling (D).
4. Install the bolts that attach front drive housing (4) to the cylinder block. Tighten the bolts evenly. Cut any excess gasket from the face of the cylinder block.

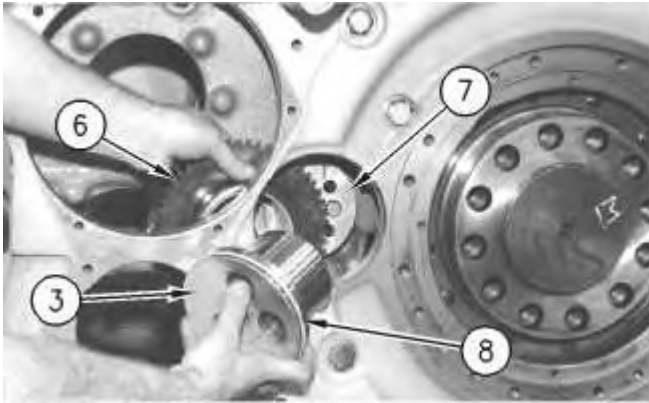

Illustration 7

g00907120

5. If the bearing was removed from gear (6), use Tooling (C) to install the bearing.
After the bearing is installed, measure the bore of the bearing. The bore of the bearing must be 90.0 ± 0.06 mm (3.54 ± 0.002 inch).
6. Coat the bore for O-ring seal (8) with clean engine oil. Install the O-ring seal on shaft (3).
7. Place washer (7) and gear (6) into position in the front drive housing. Install shaft (3). Install the bolts for shaft (3).

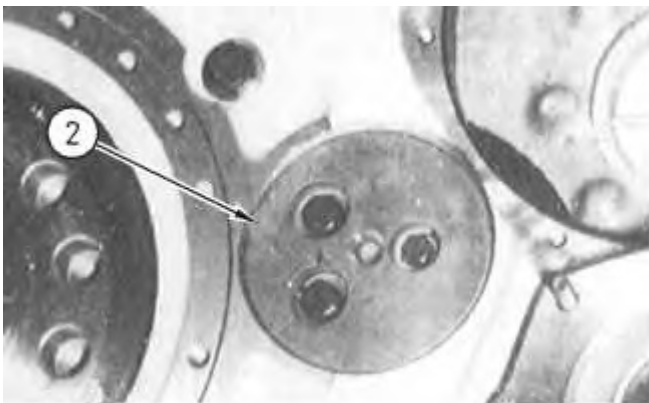

Illustration 8

g00907040

8. Coat the bore for the O-ring seal of shaft (2) with clean engine oil. Install the O-ring seal onto shaft (2).
 9. Place shaft (2) into position in the front drive housing. Install the bolts for shaft (2).
-

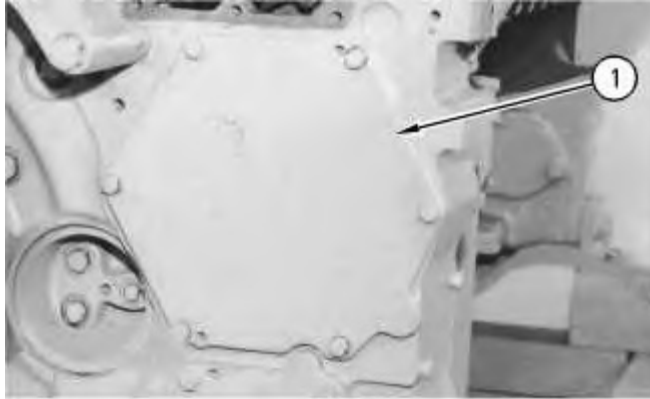

Illustration 9

g00907030

10. Install cover (1) onto the front drive housing.

End By:

- a. Install the auxiliary water pump. Refer to Disassembly and Assembly, "Auxiliary Water Pump - Install".
 - b. Install the engine oil and water pump drive. Refer to Disassembly and Assembly, "Engine Oil and Water Pump Drive - Install".
 - c. Install the accessory drive (front). Refer to Disassembly and Assembly, "Accessory Drive (Front) - Install".
 - d. Install the crankshaft front seal and the wear sleeve. Refer to Disassembly and Assembly, "Crankshaft Front Seal and Wear Sleeve - Install".
 - e. Install the engine oil filter base. Refer to Disassembly and Assembly, "Engine Oil Filter Base - Install".
-

Product: TRUCK

Model: 785C TRUCK APX

Configuration: 785C Off-Highway Truck APX00001-UP (MACHINE) POWERED BY 3512B Engine

Disassembly and Assembly

3500 and 3500B High Displacement Engines for Caterpillar Built Machines

Media Number -SEN1126-33

Publication Date -01/07/2015

Date Updated -14/09/2018

i05845178

Vibration Damper - Remove and Install

SMCS - 1205-010

Removal Procedure

Table 1

Required Tools			
Tool	Part Number	Part Description	Qty
A	-	Guide Bolts 3/8 - 16 NC by 4 inch	2
B	-	Guide Bolts 1/2 - 13 NC by 4 inch	2
C	138-7575	Link Bracket	2
D	1U-9393	Damper Guide Pin	2

Note: Some different types of vibration dampers are available for use. The following procedure describes the removal and installation of a typical vibration damper assembly and damper group.



Illustration 1

g01207380

1. Before you remove pulley (1) , make a note of the position of pulley (1) on the shaft.

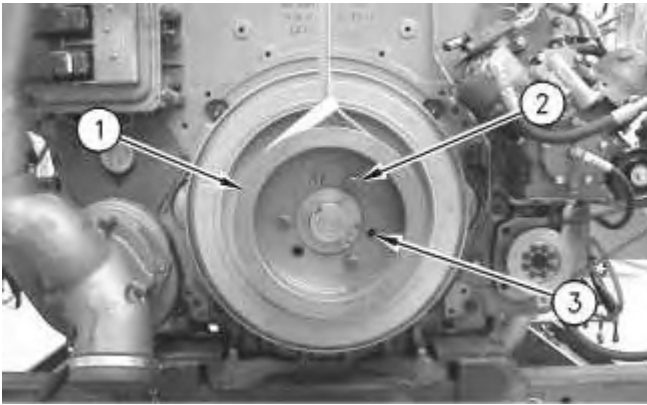

Illustration 2

g00916223

2. Install a suitable lifting device onto pulley (1) . Remove bolts (2) . Reinstall bolts (2) into holes (3) . Tighten bolts (2) enough to remove pulley (1) . The weight of pulley (1) is approximately 39 kg (85 lb).

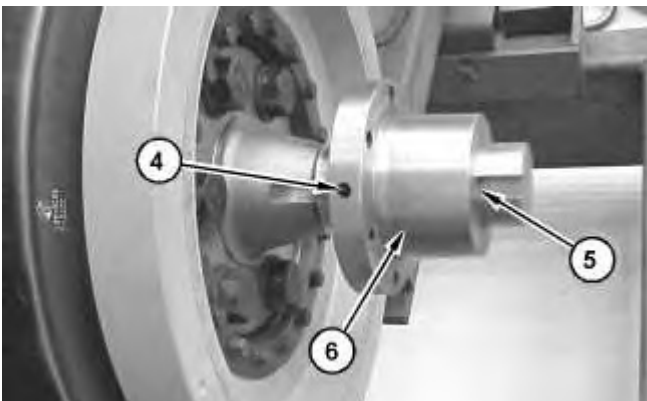

Illustration 3

g01054420

3. Loosen set screw (4) in hub (6) . Remove hub (6) and key (5) .

Note: If it was necessary to remove the vibration damper as an assembly, proceed to Step 8.



Illustration 4

g00916274

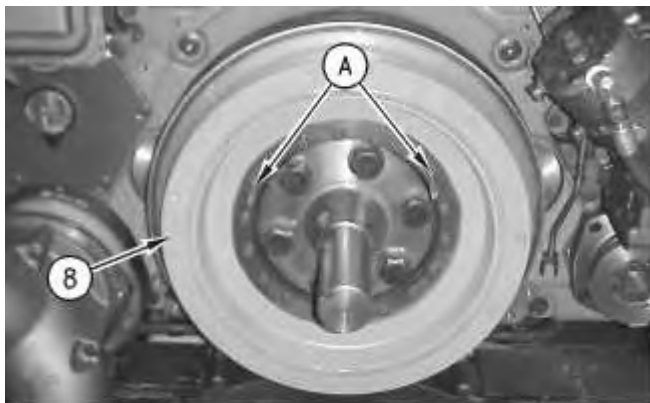

Illustration 5

g00916284

4. Remove two bolts (7) and install Tooling (A) . Remove remaining bolts (7) . Use two people and remove vibration damper (8) . The weight of vibration damper (8) is approximately 30 kg (65 lb).

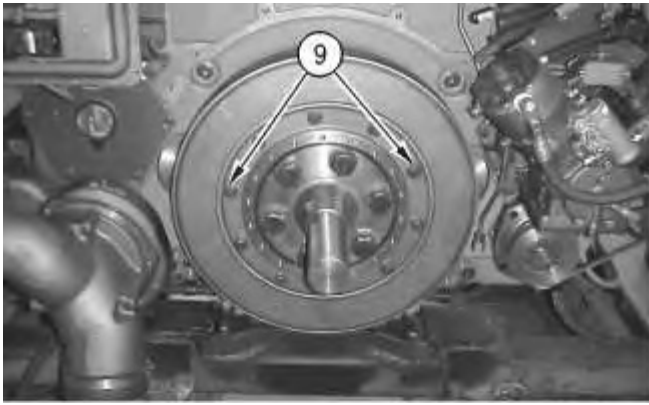

Illustration 6

g00916292

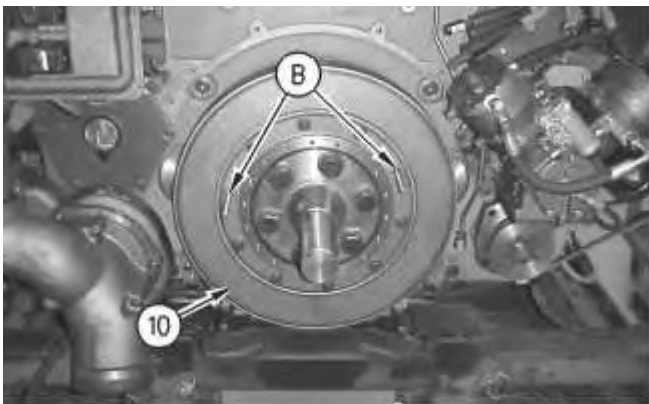

Illustration 7

g00916297

5. Remove two bolts (9) and install Tooling (B) . Remove remaining bolts (9) from vibration damper (10) .

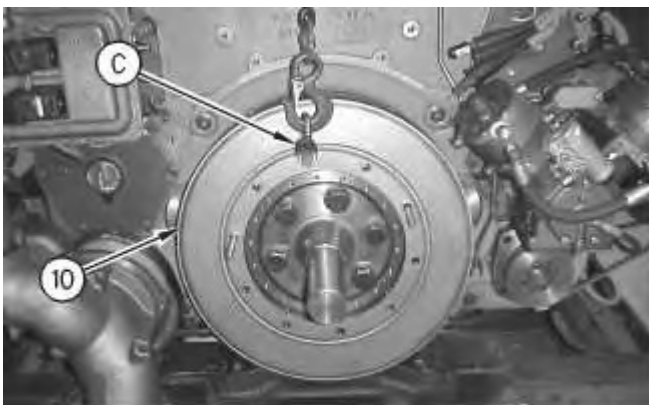

Illustration 8

g00916389

- Slide vibration damper (10) outward. Install Tooling (C) and a suitable lifting device to vibration damper (10) . Remove vibration damper (10) . The weight of vibration damper (10) is approximately 50 kg (110 lb).

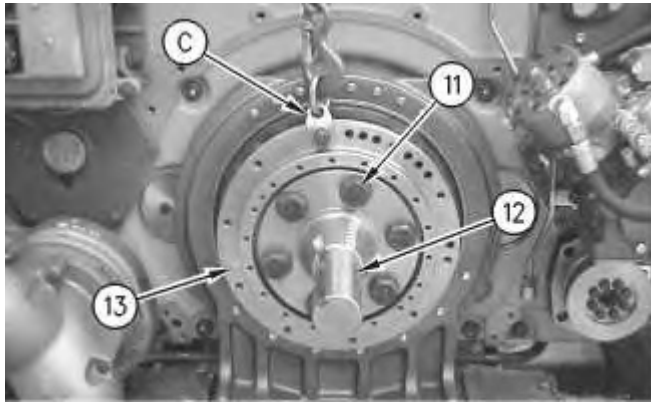

Illustration 9

g00916309

- Install Tooling (C) and attach a suitable lifting device to hub (13) . Remove bolts (11) . Remove pulley hub (12) and hub (13) . The weight of pulley hub (12) and hub (13) is approximately 36 kg (80 lb).
- The following steps are for removing the vibration damper as a complete assembly.

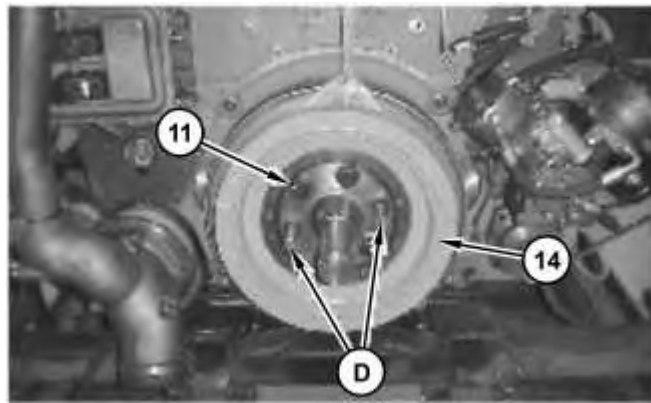

Illustration 10

g01207444

- Remove two bolts (11) . Install Tooling (D) and a suitable lifting device to vibration damper assembly (14) .
- Remove remaining bolts (11) and remove vibration damper assembly (14) . The weight of vibration damper assembly (14) is approximately 116 kg (255 lb).

Installation Procedure

Required Tools

Tool	Part Number	Part Description	Qty
A	-	Guide Bolts 3/8 - 16 NC by 4 inch	2
B	-	Guide Bolts 1/2 - 13 NC by 4 inch	2
C	138-7575	Link Bracket	2
D	1U-9393	Damper Guide Pin	2
E	-	Molybdenum Disulfide Base Lubricant	-

1. The following steps are for installation of the vibration damper as a complete assembly.

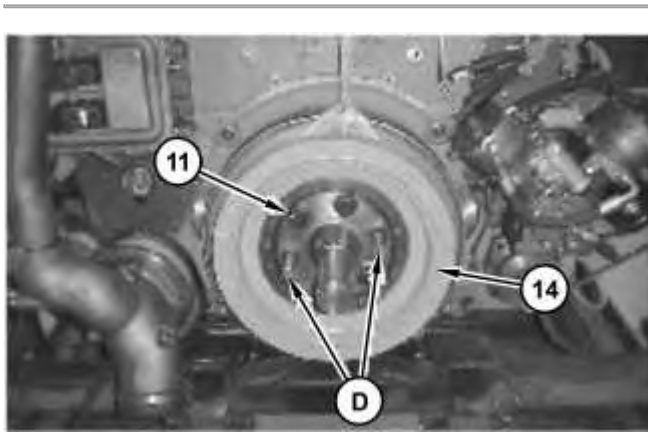

Illustration 11

g01207444

2. Install Tooling (D) . Use a suitable lifting device and slide vibration damper assembly (14) onto Tooling (D) . The weight of vibration damper assembly (14) is approximately 116 kg (255 lb). Install bolts (11) .

Note: Ensure that the mark on vibration damper (14) is aligned with the mark on the crankshaft.

Note: Apply Tooling (E) to the threads of bolts (11) prior to installation.

3. Remove Tooling (D) and install two bolts (11) .

Note: Refer to Specifications, "Vibration Damper" for the correct torque.

Note: If it was necessary to install the vibration damper as an assembly, proceed to Step 8.

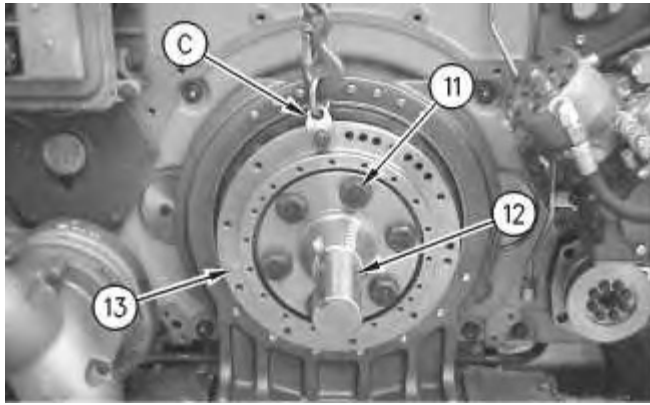

Illustration 12

g00916309

4. Install Tooling (C) and a suitable lifting device to hub (13) . Install hub (13) and pulley hub (12) . The weight of hub (13) and pulley hub (12) is approximately 36 kg (80 lb). Install bolts (11) .

Note: Apply Tooling (E) to the threads of bolts (11) prior to installation.

Note: Refer to Specifications, "Vibration Damper" for the correct torque.

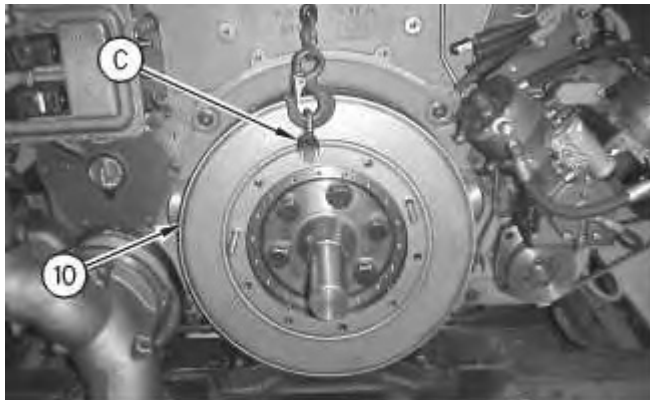

Illustration 13

g00916389

5. Install Tooling (B) . Install Tooling (C) and a suitable lifting device onto vibration damper (10) . Position vibration damper (10) onto Tooling (B) . Install vibration damper (10) . The weight of vibration damper (10) is approximately 50 kg (110 lb).

Note: Ensure that the mark on vibration damper (10) is aligned with the mark on the crankshaft.

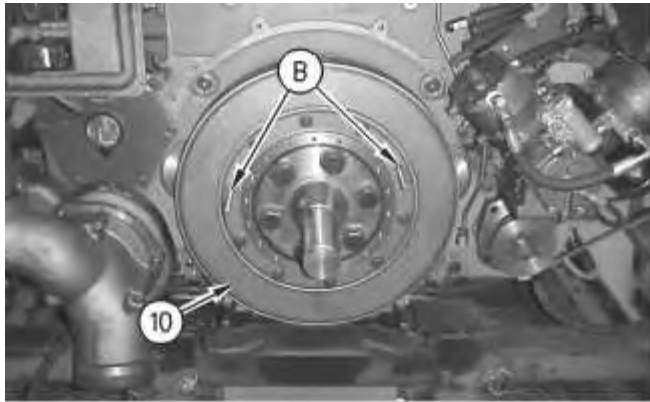

Illustration 14

g00916297

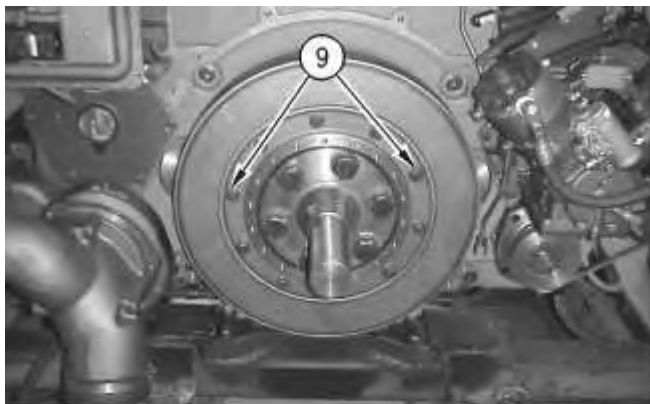

Illustration 15

g00916292

6. Install bolts (9) into vibration damper (10) . Remove Tooling (B) and install two bolts (9) .

Note: Refer to Specifications, "Vibration Damper" for the correct torque.

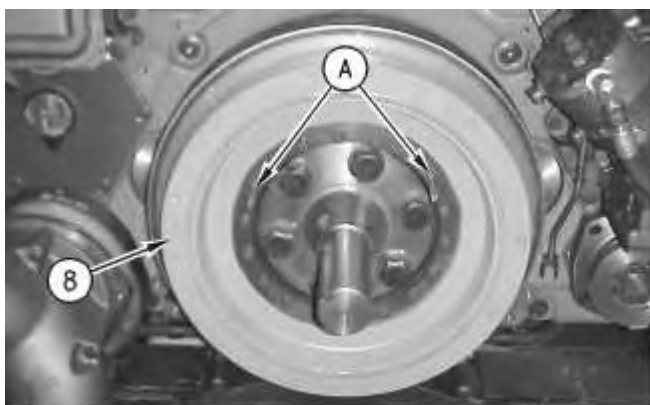

Illustration 16

g00916284



Illustration 17

g00916274

7. Install Tooling (A) . Use two people and install vibration damper (8) . The weight of vibration damper (8) is approximately 30 kg (65 lb). Install bolts (7) . Remove Tooling (A) and install two bolts (7) .

Note: Ensure that the mark on vibration damper (8) is aligned with the mark on the crankshaft.

Note: Refer to Specifications, "Vibration Damper" for the correct torque.

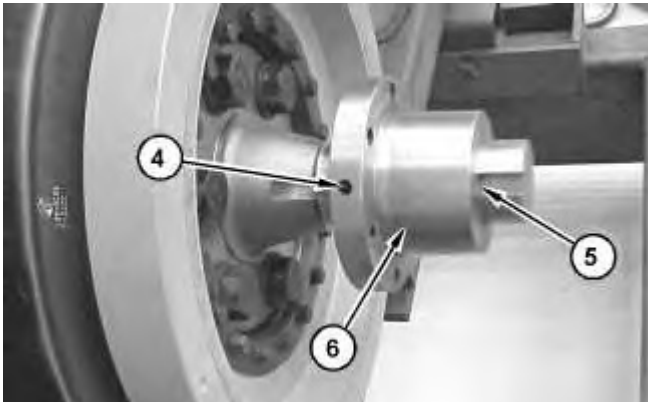

Illustration 18

g01054420

8. Install key (5) and hub (6) . Tighten set screw (4) in hub (6) .
-

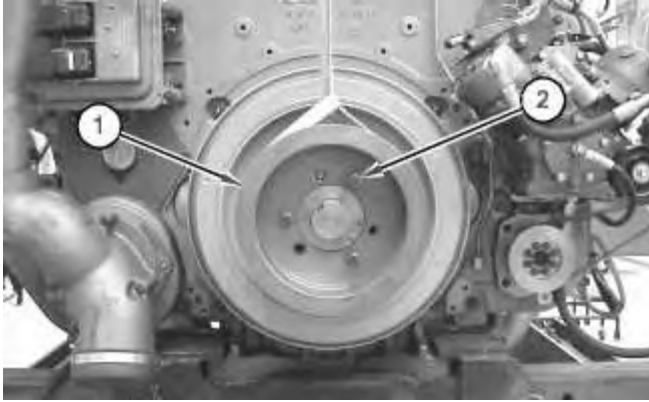

Illustration 19

g01051456

9. Install a suitable lifting device onto pulley (1) . Install pulley (1) . The weight of pulley (1) is approximately 39 kg (85 lb). Install bolts (2) .



Illustration 20

g01207380

10. Check the position of pulley (1) .
-

Product: TRUCK

Model: 785C TRUCK APX

Configuration: 785C Off-Highway Truck APX00001-UP (MACHINE) POWERED BY 3512B Engine

Disassembly and Assembly

3500 and 3500B High Displacement Engines for Caterpillar Built Machines

Media Number -SEN1126-33

Publication Date -01/07/2015

Date Updated -14/09/2018

i06616604

Crankshaft Front Seal and Wear Sleeve - Remove

SMCS - 1160-011; 7558-011

Removal Procedure

Table 1

Required Tools			
Tool	Part Number	Part Description	Qty
A	1U-7600	Slide Hammer Puller	1
B	1U-7325	Distorter Adapter	-
	6V-3143	Distorter Adapter ⁽¹⁾	-
C	5P-7409	Sleeve Distorter	1

⁽¹⁾ For use with engines equipped with a seal adapter.

Start By:

- Remove the vibration damper. Refer to Disassembly and Assembly, "Vibration Damper - Remove and Install".

NOTICE

Keep all parts clean from contaminants.

Contaminants may cause rapid wear and shortened component life.

NOTICE

Every time that the crankshaft seal is removed from the wear sleeve, a new wear sleeve and crankshaft seal must be installed.

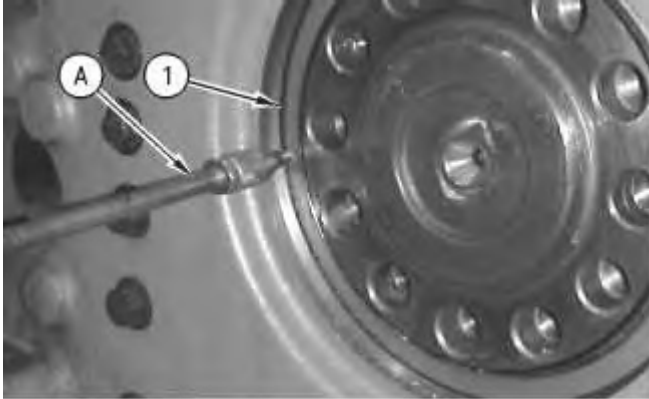

Illustration 1

g00659180

1. Drill three evenly spaced holes in crankshaft front seal (1) and use Tooling (A) to remove crankshaft front seal (1) from the front housing.

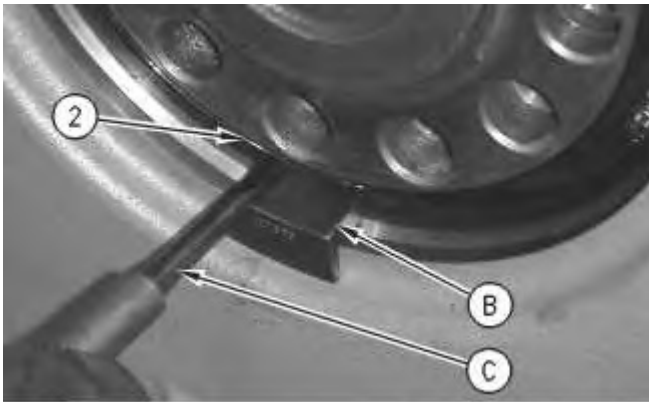

Illustration 2

g00659181

2. Insert Tooling (B) between the front housing and wear sleeve (2).

NOTICE

The use of excessive force on the sleeve distorter can cause the distorter adapter to crack the housing. To help avoid damage to the engine, do not use excessive force to remove the wear sleeve.

3. Insert Tooling (C) between Tooling (B) and wear sleeve (2). Carefully turn Tooling (C) until the edge of the tool creates a crease in wear sleeve (2).

Repeat this procedure several times around wear sleeve (2) until wear sleeve (2) can be removed by hand.



Suggest:

For more complete manuals. Please go to the home page.

<https://www.ebooklibonline.com>

If the above button click is invalid. Please download this document first, and then click the above link to download the complete manual.

Thank you so much for reading

Product: TRUCK

Model: 785C TRUCK APX

Configuration: 785C Off-Highway Truck APX00001-UP (MACHINE) POWERED BY 3512B Engine

Disassembly and Assembly

3500 and 3500B High Displacement Engines for Caterpillar Built Machines

Media Number -SEN1126-33

Publication Date -01/07/2015

Date Updated -14/09/2018

i06603192

Crankshaft Front Seal and Wear Sleeve - Install

SMCS - 1160-012; 7558-012

Installation Procedure For Seals 113-8432 and 113-8433

Table 1

Required Tools			
Tool	Part Number	Part Description	Qty
D	6V-4003 ⁽¹⁾	Seal Locator As	1
	2N-5006 ⁽¹⁾	Bolt	2
E	8T-3099 ⁽¹⁾	Seal Installer	1
F	9S-8858 ⁽¹⁾	Nut	1
G	-	Loctite 7649 Primer N	1
H	-	Loctite 620 Retaining Compound	1
J	452-6011	Multipurpose Grease	1
K	484-7863 ⁽²⁾	Tool As	1

⁽¹⁾ For installation of seals 113-8432 and 113-8433

⁽²⁾ For Installation of seals 436-1478 and 436-1479

NOTICE

Keep all parts clean from contaminants.

Contaminants may cause rapid wear and shortened component life.

NOTICE

Every time that the crankshaft seal is removed from the wear sleeve, a new wear sleeve and crankshaft seal must be installed.

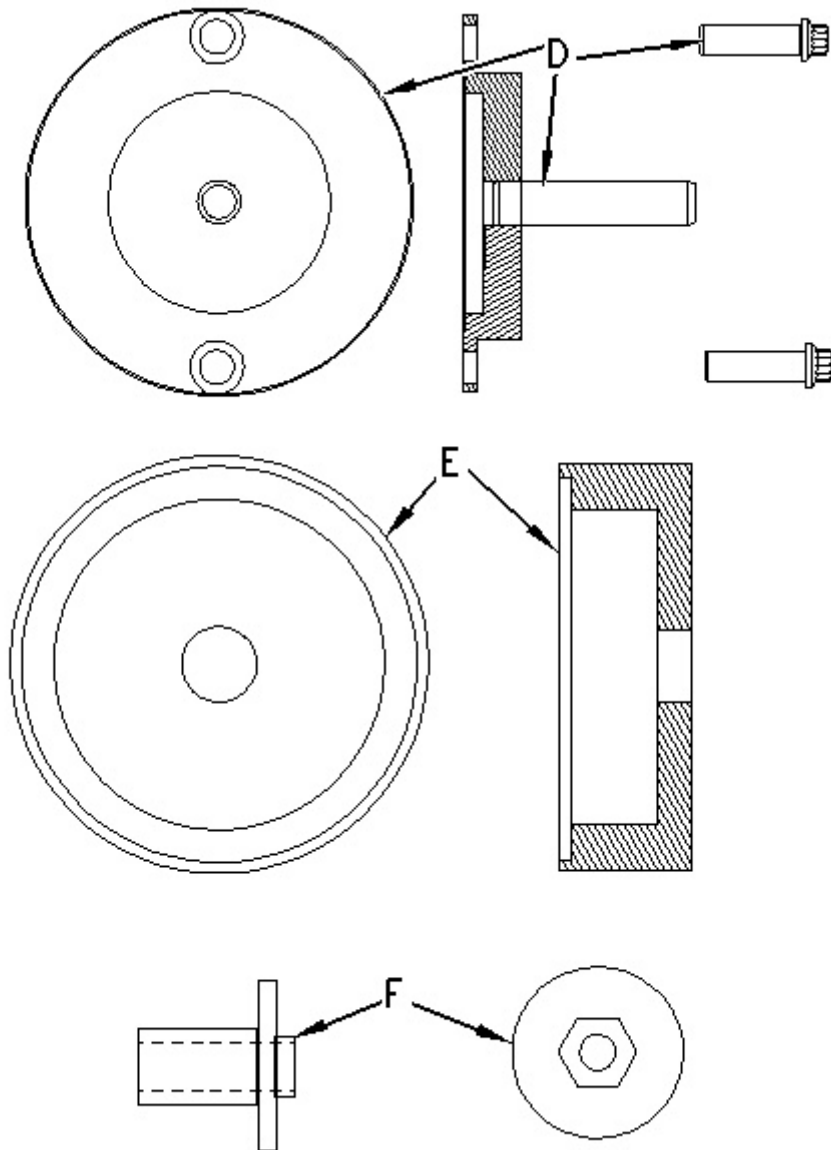

Illustration 1

g01005029

<https://www.ebooklibonline.com>

Hello dear friend!

Thank you very much for reading.

Enter the link into your browser.

The full manual is available for immediate download.

<https://www.ebooklibonline.com>