

Product: EXCAVATOR

Model: 320D LRR EXCAVATOR HJC

Configuration: 320D RR & 320D LRR Excavators HJC00001-UP (MACHINE) POWERED BY C6.4 Engine

Operation and Maintenance Manual 320D RR Excavator

Media Number -SEBU8237-09

Publication Date -01/05/2014

Date Updated -14/12/2017

s00037320

Foreword

Literature Information

This manual should be stored in the operator's compartment in the literature holder or seat back literature storage area.

This manual contains safety information, operation instructions, transportation information, lubrication information and maintenance information.

Some photographs or illustrations in this publication show details or attachments that can be different from your machine. Guards and covers might have been removed for illustrative purposes.

Continuing improvement and advancement of product design might have caused changes to your machine which are not included in this publication. Read, study and keep this manual with the machine.

Whenever a question arises regarding your machine, or this publication, please consult your Cat dealer for the latest available information.

Safety

The safety section lists basic safety precautions. In addition, this section identifies the text and locations of warning signs and labels used on the machine.

Read and understand the basic precautions listed in the safety section before operating or performing lubrication, maintenance and repair on this machine.

Operation

The operation section is a reference for the new operator and a refresher for the experienced operator. This section includes a discussion of gauges, switches, machine controls, attachment controls, transportation and towing information.

Photographs and illustrations guide the operator through correct procedures of checking, starting, operating and stopping the machine.

Operating techniques outlined in this publication are basic. Skill and techniques develop as the operator gains knowledge of the machine and its capabilities.

Maintenance

The maintenance section is a guide to equipment care. The Maintenance Interval Schedule (MIS) lists the items to be maintained at a specific service interval. Items without specific intervals are listed under the "When Required" service interval. The Maintenance Interval Schedule lists the page number for the step-by-step instructions required to accomplish the scheduled maintenance. Use the Maintenance Interval Schedule as an index or "one safe source" for all maintenance procedures.

Maintenance Intervals

Use the service hour meter to determine servicing intervals. Calendar intervals shown (daily, weekly, monthly, etc.) can be used instead of service hour meter intervals if they provide more convenient servicing schedules and approximate the indicated service hour meter reading. Recommended service should always be performed at the interval that occurs first.

Under extremely severe, dusty or wet operating conditions, more frequent lubrication than is specified in the maintenance intervals chart might be necessary.

Perform service on items at multiples of the original requirement. For example, at every 500 service hours or 3 months, also service those items listed under every 250 service hours or monthly and every 10 service hours or daily.

California Proposition 65 Warning

Diesel engine exhaust and some of its constituents are known to the State of California to cause cancer, birth defects, and other reproductive harm.

Battery posts, terminals and related accessories contain lead and lead compounds. **Wash hands after handling.**

Certified Engine Maintenance

Proper maintenance and repair is essential to keep the engine and machine systems operating correctly. As the heavy duty off-road diesel engine owner, you are responsible for the performance of the required maintenance listed in the Owner Manual, Operation and Maintenance Manual, and Service Manual.

It is prohibited for any person engaged in the business of repairing, servicing, selling, leasing, or trading engines or machines to remove, alter, or render inoperative any emission related device or element of design installed on or in an engine or machine that is in compliance with the regulations (40 CFR Part 89). Certain elements of the machine and engine such as the exhaust system, fuel system, electrical system, intake air system and cooling system may be emission related and should not be altered unless approved by Caterpillar.

Machine Capacity

Additional attachments or modifications may exceed machine design capacity which can adversely affect performance characteristics. Included would be stability and system certifications such as brakes, steering, and rollover protective structures (ROPS). Contact your Cat dealer for further information.

Cat Product Identification Number

Effective First Quarter 2001 the Cat Product Identification Number (PIN) has changed from 8 to 17 characters. In an effort to provide uniform equipment identification, Caterpillar and other construction equipment manufacturers are moving to comply with the latest version of the product identification numbering standard. Non-road machine PINs are defined by ISO 10261. The new PIN format will apply to all Cat machines and generator sets. The PIN plates and frame marking will display the 17 character PIN. The new format will look like the following:



Illustration 1

g00751314

Where:

1. Caterpillar's World Manufacturing Code (characters 1-3)
2. Machine Descriptor (characters 4-8)
3. Check Character (character 9)
4. Machine Indicator Section (MIS) or Product Sequence Number (characters 10-17). These were previously referred to as the Serial Number.

Machines and generator sets produced before First Quarter 2001 will maintain their 8 character PIN format.

<https://www.ebooklibonline.com>

Hello dear friend!

Thank you very much for reading.

Enter the link into your browser.

The full manual is available for immediate download.

<https://www.ebooklibonline.com>

Components such as engines, transmissions, axles, etc. and work tools will continue to use an 8 character Serial Number (S/N).

Product: EXCAVATOR

Model: 320D LRR EXCAVATOR HJC

Configuration: 320D RR & 320D LRR Excavators HJC00001-UP (MACHINE) POWERED BY C6.4 Engine

Operation and Maintenance Manual

320D RR Excavator

Media Number -SEBU8237-09

Publication Date -01/05/2014

Date Updated -14/12/2017

i04009691

Safety Messages

SMCS - 7000; 7405

There are several specific safety messages on this machine. The exact location of the hazards and the description of the hazards are reviewed in this section. Please become familiarized with all safety messages.

Make sure that all of the safety messages are legible. Clean the safety messages or replace the safety messages if you cannot read the words. Replace the illustrations if the illustrations are not visible. When you clean the safety messages, use a cloth, water, and soap. Do not use solvent, gasoline, or other harsh chemicals to clean the safety messages. Solvents, gasoline, or harsh chemicals could loosen the adhesive that secures the safety message. Loose adhesive will allow the safety message to fall.

Replace any safety message that is damaged, or missing. If a safety message is attached to a part that is replaced, install a safety message on the replacement part. Any Caterpillar dealer can provide new safety messages.

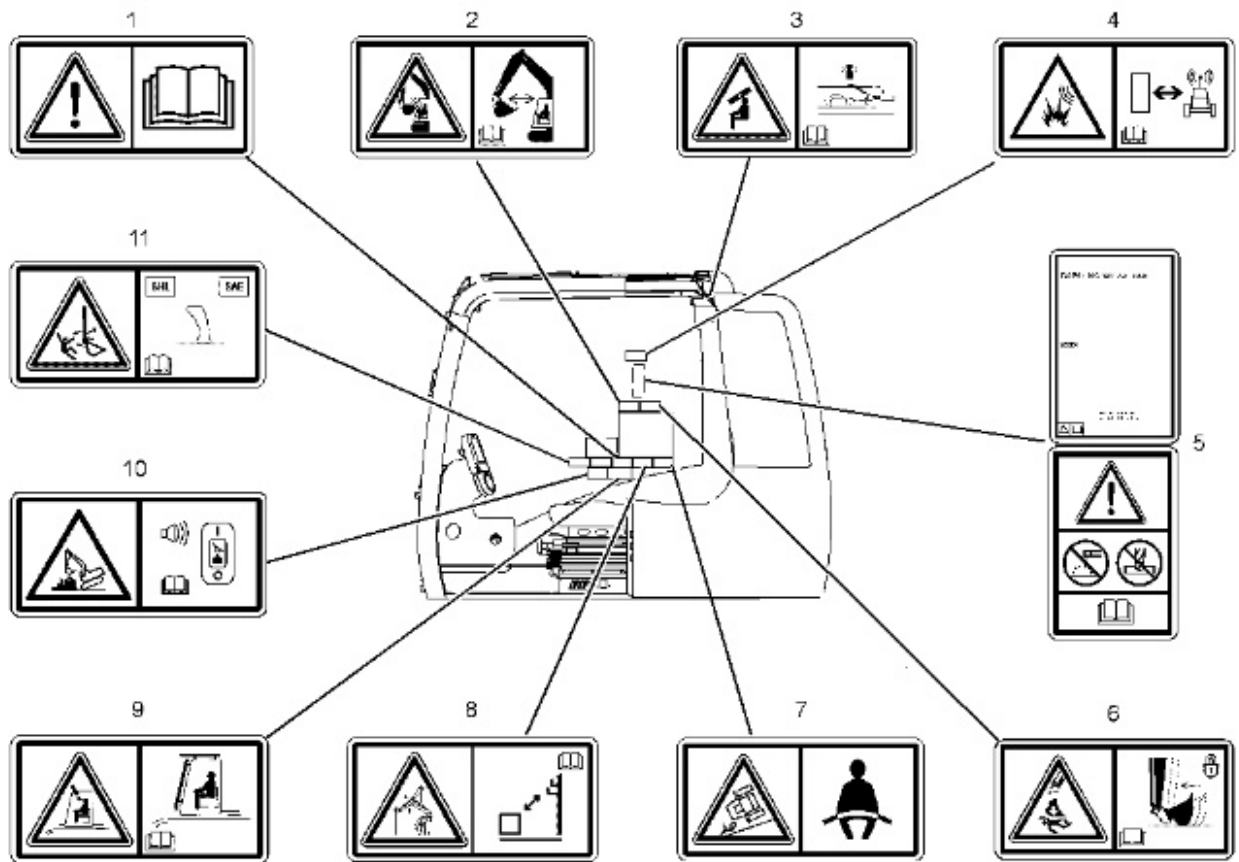

Illustration 1
View of the cab

g01972174

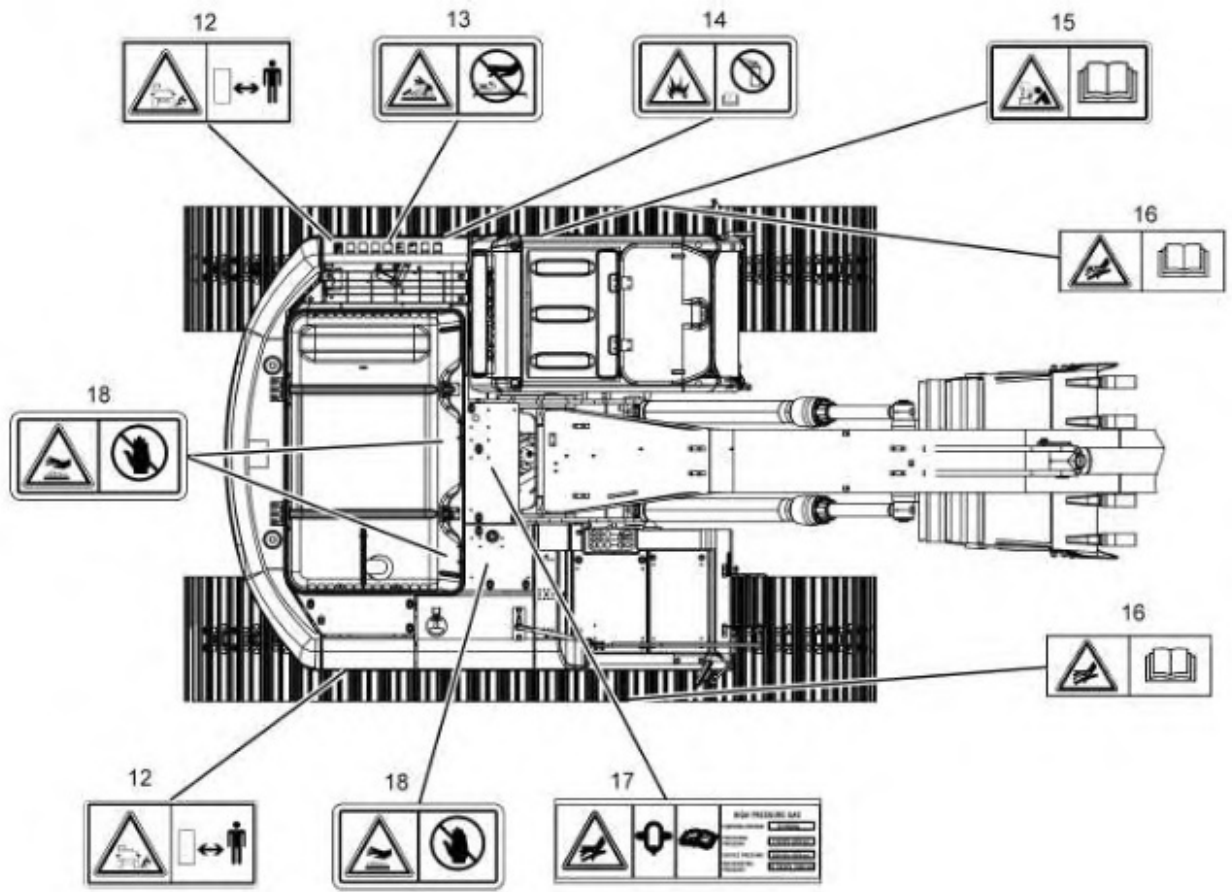

Illustration 2
Top view of machine

g01972175

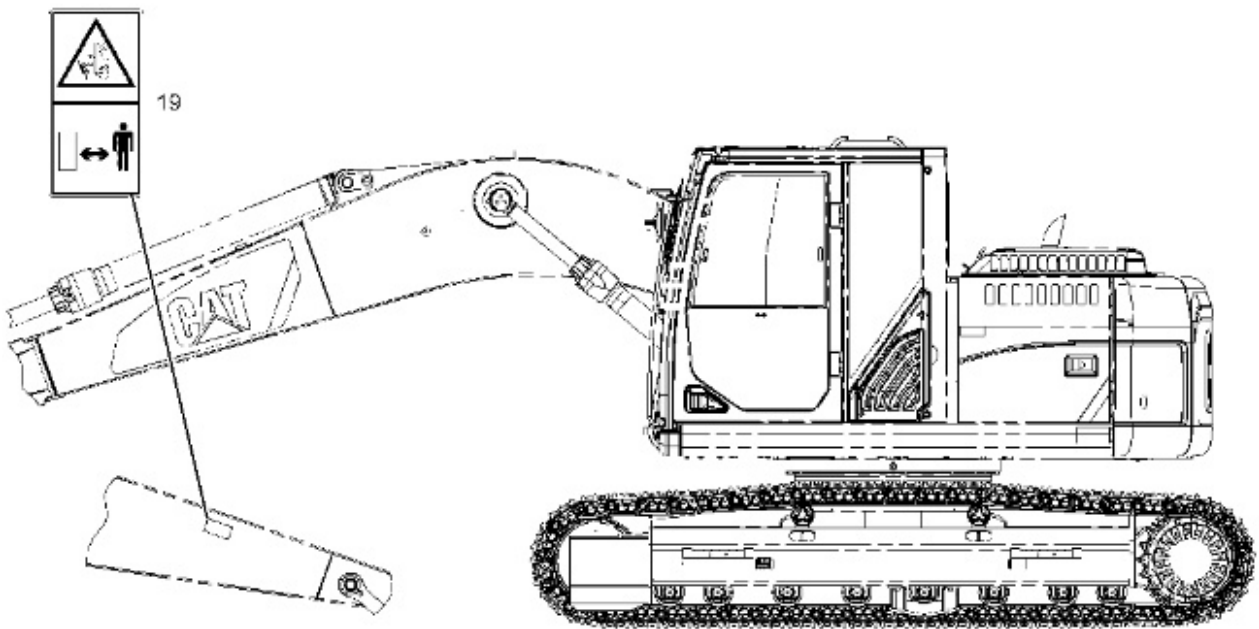

Illustration 3
Side view

g02183016

Do Not Operate (1)

This safety message is located in the cab on the right side window.



Illustration 4

g01370904

 **WARNING**

Do not operate or work on this machine unless you have read and understand the instructions and warnings in the Operation and Maintenance Manual. Failure to follow the instructions or heed the warnings could result in injury or death. Contact any Caterpillar dealer for replacement manuals. Proper care is your responsibility.

Crushing Hazard (2)

This safety message is located in the cab on the right side window.

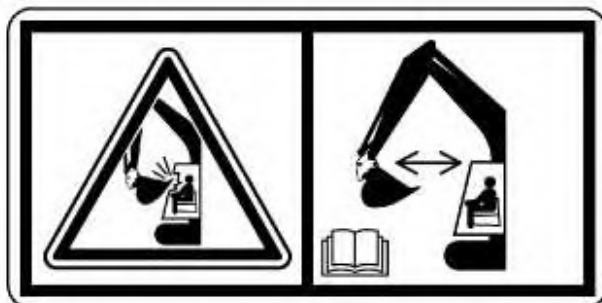

Illustration 5

g01373971

 **WARNING**

Crushing Hazard! Certain machine front linkage combinations (boom, stick, quick coupler, work tool) may require keeping the work tool away from the cab during operation. Personal injury or death may result if the work tool contacts the cab during operation.

Crushing Hazard (3)

This safety message is located in rear of the cab.



Illustration 6

g01373978



Personal injury can result if the window is not latched in the overhead position; ensure the auto lock is engaged.

Refer to Operation and Maintenance Manual, "Window (Front)" for further information.

Product Link (4)

If equipped, this safety message is positioned in the cab on the right side window.

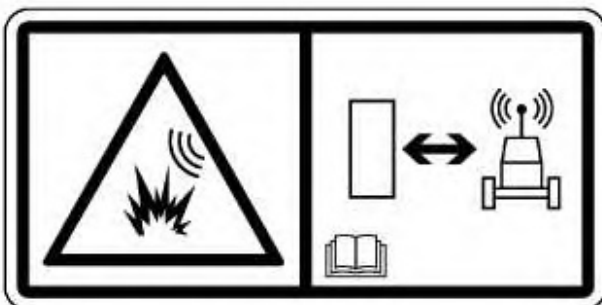



This machine is equipped with a Caterpillar Product Link communication device. When electric/electronic detonators are used, this communication device should be deactivated within 12 m (40 ft) of a blast site, or within the distance mandated under applicable legal requirements. Failure to do so could cause interference with blasting operations and result in serious injury or death.

Refer to Operation and Maintenance Manual , "Product Link" for further information.

Do Not Weld or Drill on ROPS (5)

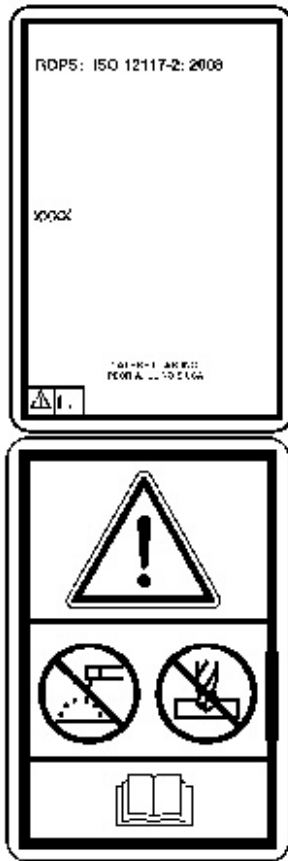

If equipped, this safety message is located on the left side pillar in the cab.



Structural damage, an overturn, modification, alteration, or improper repair, can impair this structure's protective capability thereby voiding this certification. Do not weld on or drill holes in the structure. Consult a Caterpillar dealer to determine this structure's limitations without voiding its certification.

This machine has been certified to the standards that are listed on the certification plate. The maximum mass of the machine, which includes the operator and the attachments without a payload, should not exceed the mass on the certification plate.

Refer to Operation and Maintenance Manual, "Guards (Operator Protection)" for more information.

Crushing Injury (6)

If equipped, this safety message is located in the cab on the right side window.



Illustration 9

g01374035

 **WARNING**

Crush injury. Could cause serious injury or death. Always confirm that the quick coupler is engaged onto the pins. Read the Operator's Manual.

Refer to Operation and Maintenance Manual, "Quick Coupler Operation" for further information.

Seat Belt (7)

This safety message is located in the cab on the right side window.



Illustration 10

g01370908

WARNING

A seat belt should be worn at all times during machine operation to prevent serious injury or death in the event of an accident or machine overturn. Failure to wear a seat belt during machine operation may result in serious injury or death.

Electrical Power Lines (8)

This safety message is located in the cab.

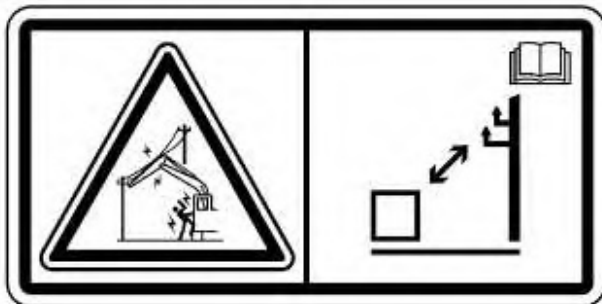

Illustration 11

g01374045

DANGER

Electrocution Hazard! Keep the machine and attachments a safe distance from electrical power. Stay clear 3 m (10 ft) plus twice the line insulator length. Read and understand the instructions and warnings in the

Operation and Maintenance Manual. Failure to follow the instructions and warnings will cause serious injury or death

Refer to Operation and Maintenance Manual, "Specifications" for further information.

Crushing Hazard (9)

This safety message is located in the cab on the right side window.



Illustration 12

g01374048

! WARNING

The impact from objects that strike the front of the cab or the top of the cab could result in a crushing hazard with the potential for personal injury or death.

The front guard and the top guard should be installed on the cab for applications where the hazard of falling objects exist. Read the Operation and Maintenance Manual.

Refer to Operation and Maintenance Manual, "Guards" for further information.

Overload Warning Device (10)

If equipped, this safety message is located in the cab on the right side window.

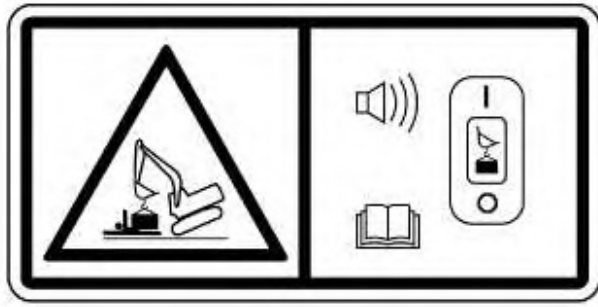

Illustration 13

g01602013

WARNING

Overloading the machine could impact the machine's stability which could result in a tipover hazard. A tipover hazard could result in serious injury or death. Always activate the overload warning device before you handle or lift objects.

Refer to Operation and Maintenance Manual, "Operator Controls" for further information.

Joystick Controls Alternate Patterns (11)

If equipped, this safety message is located in the cab on the right side window.



Illustration 14

g01374050

WARNING

Crush Hazard. Improper joystick setting could cause possible unexpected movement of the boom, stick, or worktool which could result in serious injury or death. Confirm that the joystick settings are

properly configured before you operate the machine. Read the Operation and Maintenance Manual.

Refer to Operation and Maintenance Manual, "Joystick Controls Alternate Patterns" for further information.

Crushing Hazard (12)

This safety message is located on the rear of each side of the machine. This safety message is also located on each side of the counterweight.

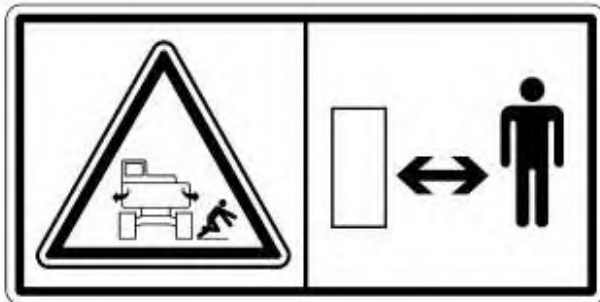

Illustration 15

g01374060



Machine swings. Stay back. Crushing hazard could cause serious injury or death.

Pressurized System (13)

This safety message is located inside the engine compartment next to the cooling system filler cap.



 **WARNING**

Pressurized system! Hot coolant can cause serious burns, injury or death. To open the cooling system filler cap, stop the engine and wait until the cooling system components are cool. Loosen the cooling system pressure cap slowly in order to relieve the pressure. Read and understand the Operation and Maintenance Manual before performing any cooling system maintenance.

Refer to Operation and Maintenance Manual, "Cooling System Coolant Level - Check" for further information.

Aerosol Starting Aid (14)

This safety message is positioned on the cover of the intake duct of the air cleaner. The following information is not applicable to machines that are equipped with an ether starting aid.

 **WARNING**

Explosion hazard! Do not use ether! This machine is equipped with an air inlet heater. Using ether can create explosions or fires that can cause personal injury or death. Read and follow the starting procedure in the Operation and Maintenance Manual.

Refer to Operation and Maintenance Manual, "Engine Starting" for the proper starting procedure.

Jump Start Cables (15)

This safety message is positioned on the circuit breaker panel.

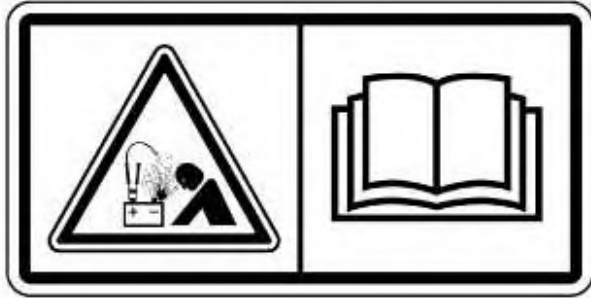

Illustration 18

g01370909



Explosion Hazard! Improper jumper cable connections can cause an explosion resulting in serious injury or death. Batteries may be located in separate compartments. Refer to the Operation and Maintenance Manual for the correct jump starting procedure.

Refer to Operation and Maintenance Manual, "Engine Starting with Jump Start Cables" for further information.

High Pressure Cylinder (16)

This safety message is positioned on the track adjuster on both sides of the machine.

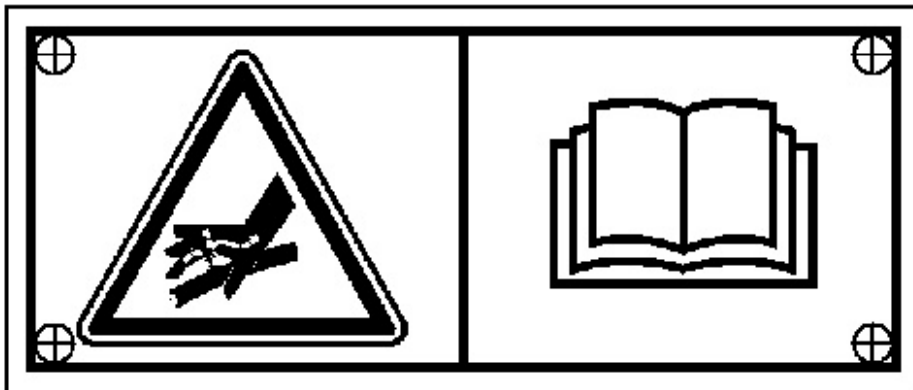

Illustration 19

g01076729

WARNING

High Pressure Cylinder. Do not remove any parts from the cylinder until all of the pressure has been relieved. This will prevent possible personal injury or death.

Refer to Operation and Maintenance Manual, "Track Adjustment - Adjust" for the adjustment procedure.

High Pressure Gas (17)

This safety message is positioned on the accumulator.

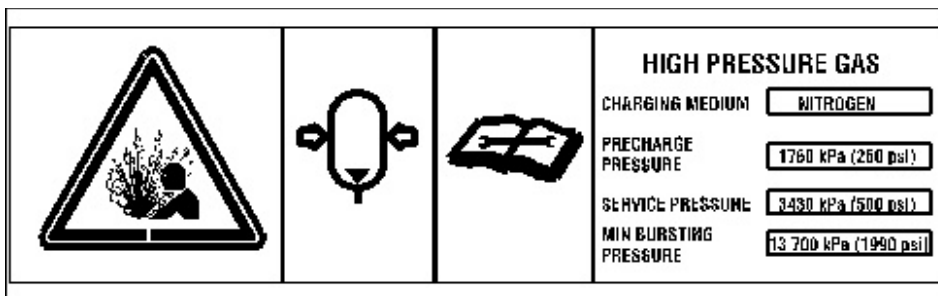

Illustration 20

g01055412

WARNING

This system contains high pressure gas. Failure to follow the instructions and warnings could cause an explosion, resulting in possible injury or death.

Do not expose to fire. Do not weld. Do not drill. Relieve pressure before discharging.

See Operation and Maintenance Manual for charging and discharging. See your Caterpillar Dealer for tools and detailed information.

Refer to Operation and Maintenance Manual, "Equipment Lowering with Engine Stopped" for further information.

Hot Surface (18)

This safety message is located on the engine hood in two places.



Illustration 21

g01372256



Hot parts or hot components can cause burns or personal injury. Do not allow hot parts or components to contact your skin. Use protective clothing or protective equipment to protect your skin.

Crushing Hazard (19)

This safety message is located on both sides of the stick.

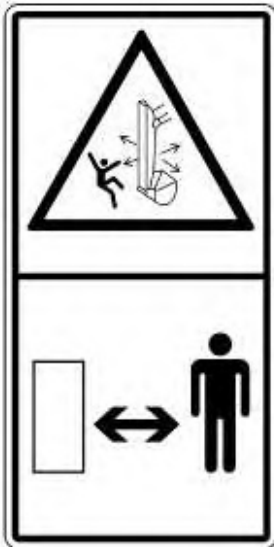

Illustration 22

g01385579





Suggest:

For more complete manuals. Please go to the home page.

<https://www.ebooklibonline.com>

If the above button click is invalid. Please download this document first, and then click the above link to download the complete manual.

Thank you so much for reading

A crushing hazard exists when the stick and boom are in motion and when the machine is being used in object handling applications. Failure to stay clear of the stick and boom when the machine is in operation can result in personal injury or death. Stay clear of the stick and boom when the machine is in operation.

Product: EXCAVATOR

Model: 320D LRR EXCAVATOR HJC

Configuration: 320D RR & 320D LRR Excavators HJC00001-UP (MACHINE) POWERED BY C6.4 Engine

Operation and Maintenance Manual 320D RR Excavator

Media Number -SEBU8237-09

Publication Date -01/05/2014

Date Updated -14/12/2017

i02934437

Additional Messages

SMCS - 7000; 7405

There are several specific messages on this machine. The exact location of the messages and the description of the information are reviewed in this section. Please become familiar with all messages.

Make sure that all of the messages are legible. Clean the messages or replace the messages if you cannot read the words. Replace the illustrations if the illustrations are not legible. When you clean the messages, use a cloth, water, and soap. Do not use solvent, gasoline, or other harsh chemicals to clean the messages. Solvents, gasoline, or harsh chemicals could loosen the adhesive that secures the messages. Loose adhesive will allow the messages to fall.

Replace any message that is damaged, or missing. If a message is attached to a part that is replaced, install a message on the replacement part. Any Caterpillar dealer can provide new messages.

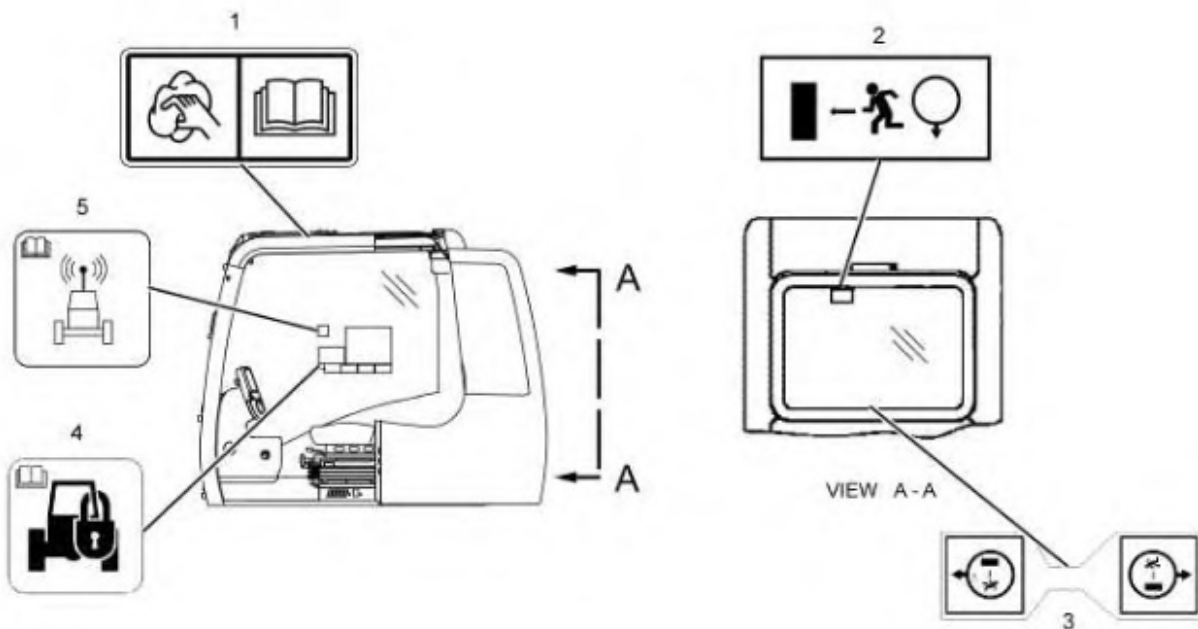

<https://www.ebooklibonline.com>

Hello dear friend!

Thank you very much for reading.

Enter the link into your browser.

The full manual is available for immediate download.

<https://www.ebooklibonline.com>