

Product: EXCAVATOR

Model: 320C EXCAVATOR HBC

Configuration: 320C Excavators HBC00001-UP (MACHINE) POWERED BY 3066 Engine

Operation and Maintenance Manual 320C Excavator

Media Number -SEBU7456-02

Publication Date -01/11/2008

Date Updated -04/11/2008

s00037320

Foreword

SMCS - 7606

Literature Information

This manual should be stored in the operator's compartment in the literature holder or seat back literature storage area.

This manual contains safety information, operation instructions, transportation information, lubrication information and maintenance information.

Some photographs or illustrations in this publication show details or attachments that can be different from your machine. Guards and covers might have been removed for illustrative purposes.

Continuing improvement and advancement of product design might have caused changes to your machine which are not included in this publication. Read, study and keep this manual with the machine.

Whenever a question arises regarding your machine, or this publication, please consult your Cat dealer for the latest available information.

Safety

The safety section lists basic safety precautions. In addition, this section identifies the text and locations of warning signs and labels used on the machine.

Read and understand the basic precautions listed in the safety section before operating or performing lubrication, maintenance and repair on this machine.

Operation

The operation section is a reference for the new operator and a refresher for the experienced operator. This section includes a discussion of gauges, switches, machine controls, attachment controls, transportation and towing information.

Photographs and illustrations guide the operator through correct procedures of checking, starting, operating and stopping the machine.

Operating techniques outlined in this publication are basic. Skill and techniques develop as the operator gains knowledge of the machine and its capabilities.

Maintenance

The maintenance section is a guide to equipment care. The Maintenance Interval Schedule (MIS) lists the items to be maintained at a specific service interval. Items without specific intervals are listed under the "When Required" service interval. The Maintenance Interval Schedule lists the page number for the step-by-step instructions required to accomplish the scheduled maintenance. Use the Maintenance Interval Schedule as an index or "one safe source" for all maintenance procedures.

Maintenance Intervals

Use the service hour meter to determine servicing intervals. Calendar intervals shown (daily, weekly, monthly, etc.) can be used instead of service hour meter intervals if they provide more convenient servicing schedules and approximate the indicated service hour meter reading. Recommended service should always be performed at the interval that occurs first.

Under extremely severe, dusty or wet operating conditions, more frequent lubrication than is specified in the maintenance intervals chart might be necessary.

Perform service on items at multiples of the original requirement. For example, at every 500 service hours or 3 months, also service those items listed under every 250 service hours or monthly and every 10 service hours or daily.

California Proposition 65 Warning

Diesel engine exhaust and some of its constituents are known to the State of California to cause cancer, birth defects, and other reproductive harm.

Battery posts, terminals and related accessories contain lead and lead compounds. **Wash hands after handling.**

Certified Engine Maintenance

Proper maintenance and repair is essential to keep the engine and machine systems operating correctly. As the heavy duty off-road diesel engine owner, you are responsible for the performance of the required maintenance listed in the Owner Manual, Operation and Maintenance Manual, and Service Manual.

It is prohibited for any person engaged in the business of repairing, servicing, selling, leasing, or trading engines or machines to remove, alter, or render inoperative any emission related device or element of design installed on or in an engine or machine that is in compliance with the

regulations (40 CFR Part 89). Certain elements of the machine and engine such as the exhaust system, fuel system, electrical system, intake air system and cooling system may be emission related and should not be altered unless approved by Caterpillar.

Machine Capacity

Additional attachments or modifications may exceed machine design capacity which can adversely affect performance characteristics. Included would be stability and system certifications such as brakes, steering, and rollover protective structures (ROPS). Contact your Cat dealer for further information.

Cat Product Identification Number

Effective First Quarter 2001 the Cat Product Identification Number (PIN) has changed from 8 to 17 characters. In an effort to provide uniform equipment identification, Caterpillar and other construction equipment manufacturers are moving to comply with the latest version of the product identification numbering standard. Non-road machine PINs are defined by ISO 10261. The new PIN format will apply to all Cat machines and generator sets. The PIN plates and frame marking will display the 17 character PIN. The new format will look like the following:



Illustration 1

g00751314

Where:

1. Caterpillar's World Manufacturing Code (characters 1-3)
2. Machine Descriptor (characters 4-8)
3. Check Character (character 9)
4. Machine Indicator Section (MIS) or Product Sequence Number (characters 10-17). These were previously referred to as the Serial Number.

<https://www.ebooklibonline.com>

Hello dear friend!

Thank you very much for reading.

Enter the link into your browser.

The full manual is available for immediate download.

<https://www.ebooklibonline.com>

Machines and generator sets produced before First Quarter 2001 will maintain their 8 character PIN format.

Components such as engines, transmissions, axles, etc. and work tools will continue to use an 8 character Serial Number (S/N).

Product: EXCAVATOR

Model: 320C EXCAVATOR HBC

Configuration: 320C Excavators HBC00001-UP (MACHINE) POWERED BY 3066 Engine

Operation and Maintenance Manual 320C Excavator

Media Number -SEBU7456-02

Publication Date -01/11/2008

Date Updated -04/11/2008

i02199235

Safety Messages - Arrangement I

SMCS - 7000; 7405

There are several specific safety messages on this machine. The exact location of the hazards and the description of the hazards are reviewed in this section. Please become familiarized with all safety messages.

Make sure that all of the safety messages are legible. Clean the safety messages or replace the safety messages if you cannot read the words. Replace the illustrations if the illustrations are not visible. When you clean the safety messages, use a cloth, water and soap. Do not use solvent, gasoline, or other harsh chemicals to clean the safety messages. Solvents, gasoline, or harsh chemicals could loosen the adhesive that secures the safety message. Loose adhesive will allow the safety message to fall.

Replace any safety message that is damaged, or missing. If a safety message is attached to a part that is replaced, install a safety message on the replacement part. Any Caterpillar dealer can provide new safety messages.

Do Not Operate

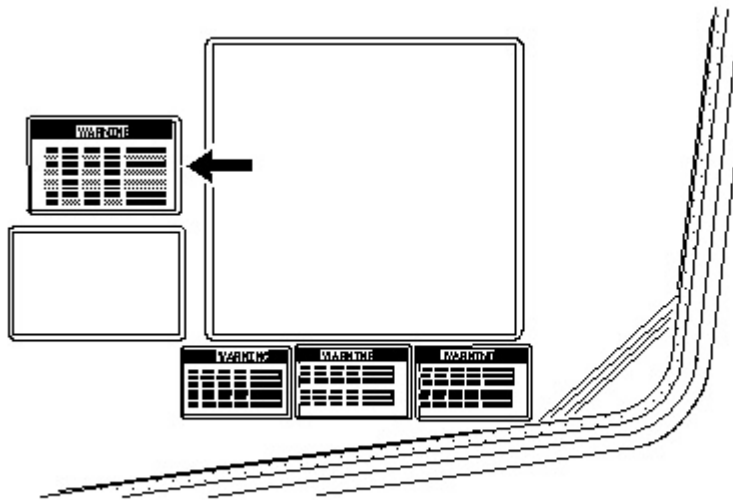
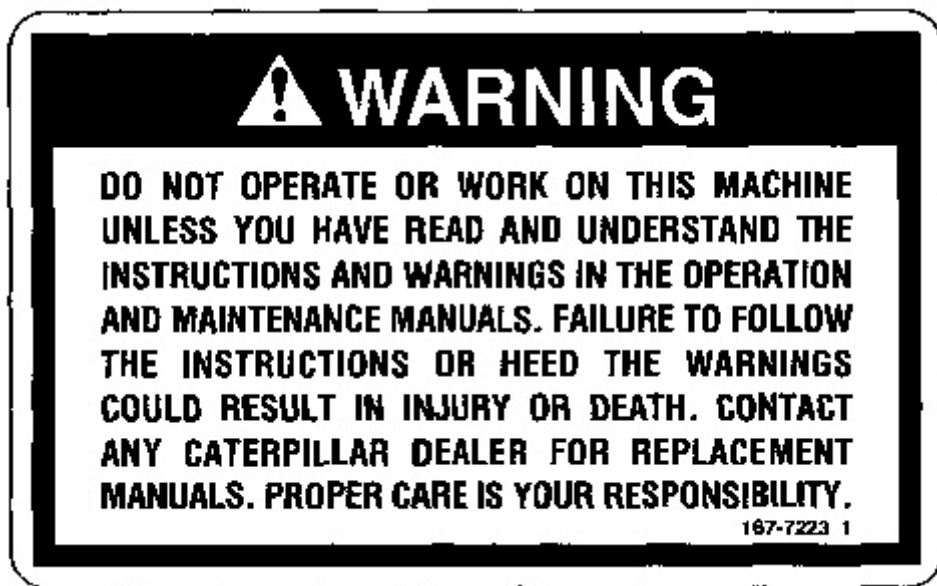

Illustration 1

g00103455

This safety message is located in the cab.



g00684449



DO NOT OPERATE OR WORK ON THIS MACHINE UNLESS YOU HAVE READ AND UNDERSTAND THE INSTRUCTIONS AND WARNINGS IN THE OPERATION AND MAINTENANCE MANUALS. FAILURE TO FOLLOW THE INSTRUCTIONS OR HEED THE WARNINGS COULD RESULT IN INJURY OR DEATH.

CONTACT ANY CATERPILLAR DEALER FOR REPLACEMENT
MANUALS. PROPER CARE IS YOUR RESPONSIBILITY.

Electrical Power Lines

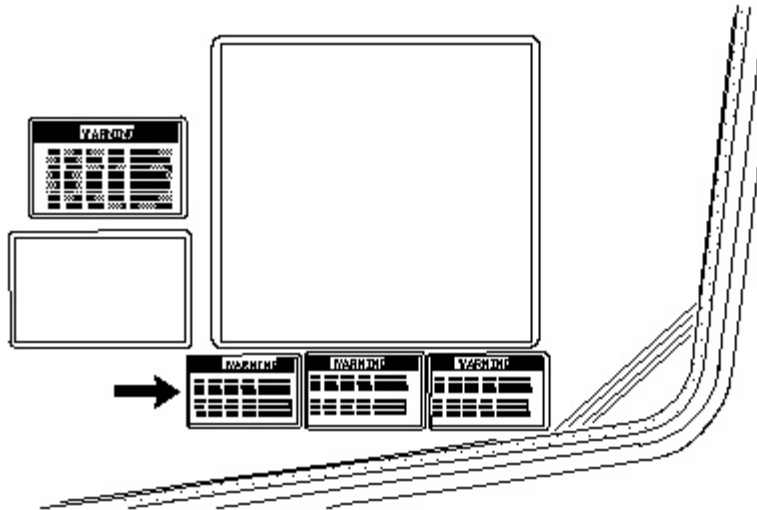
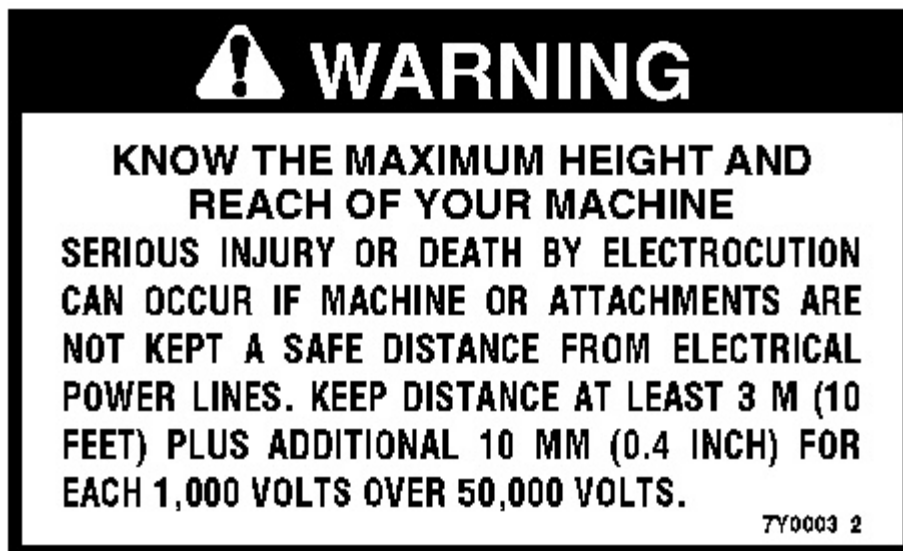

Illustration 2

g00103447

This safety message is located in the cab.



g00100702



WARNING

Know the maximum height and reach of your machine. Serious injury or death by electrocution can occur if machine, work tools, or attachments are not kept a safe distance from electrical power lines. Keep distance at least 3 m (10 ft) Plus additional 10 mm (.4 inch) for each 1,000 volts over 50,000 volts.

Crushing Hazard

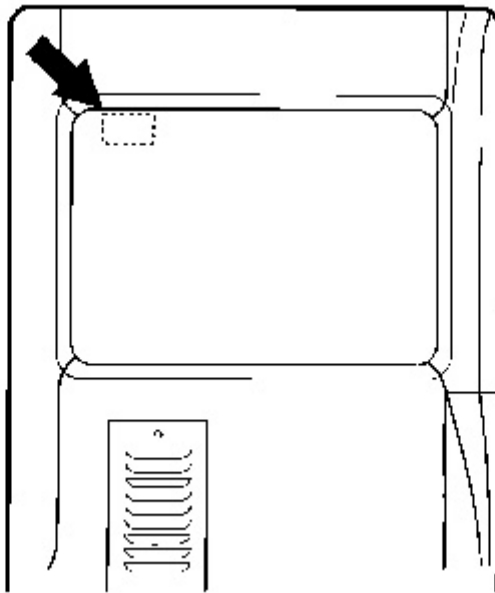

Illustration 3

g00683827

This safety message is located in the cab.



g00684465



Personal injury can result if the window is not latched in the overhead position; ensure the auto lock is engaged.

Jump Start Cables

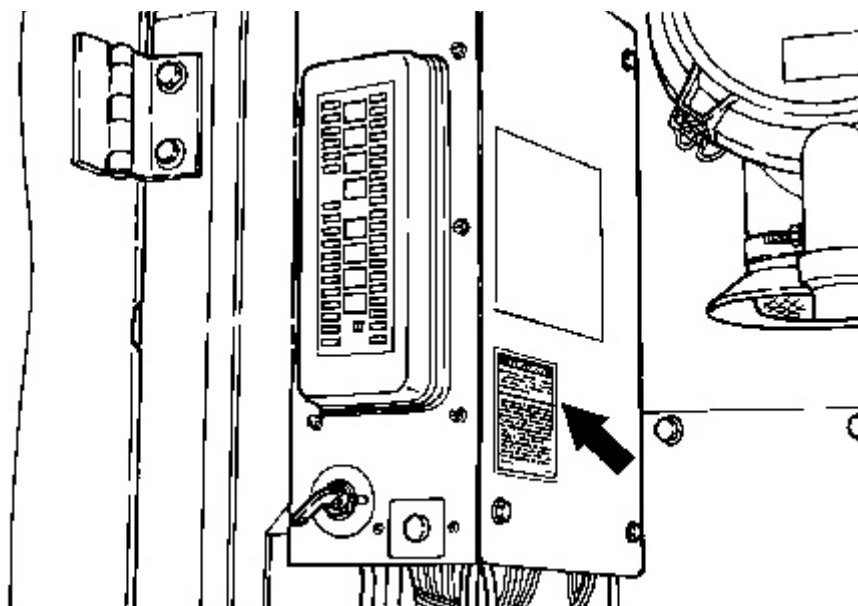



Illustration 4

g00683818

This safety message is located on the circuit breaker panel.

 **WARNING**

IMPROPER JUMPER CABLE CONNECTIONS CAN CAUSE EXPLOSION RESULTING IN PERSONAL INJURY.

BATTERIES MAY BE LOCATED IN SEPARATE COMPARTMENTS. WHEN USING JUMPER CABLES, ALWAYS CONNECT POSITIVE (+) CABLE TO POSITIVE (+) TERMINAL OF BATTERY CONNECTED TO STARTER SOLENOID AND NEGATIVE (-) CABLE FROM EXTERNAL SOURCE TO STARTER NEGATIVE (-) TERMINAL (IF MACHINE NOT EQUIPPED WITH STARTER NEGATIVE TERMINAL, CONNECT TO ENGINE BLOCK.) FOLLOW PROCEDURE IN THE OPERATION MANUAL.

5V-4611 4

g00038786



IMPROPER JUMPER CABLE CONNECTIONS CAN CAUSE EXPLOSION RESULTING IN PERSONAL INJURY.

BATTERIES MAY BE LOCATED IN SEPARATE COMPARTMENTS. WHEN USING JUMPER CABLES, ALWAYS

CONNECT POSITIVE (+) CABLE TO POSITIVE (+) TERMINAL OF BATTERY CONNECTED TO STARTER SOLENOID AND NEGATIVE (-) CABLE FROM EXTERNAL SOURCE TO STARTER NEGATIVE (-) TERMINAL (IF MACHINE NOT EQUIPPED WITH STARTER NEGATIVE TERMINAL, CONNECT TO ENGINE BLOCK.) FOLLOW PROCEDURE IN THE OPERATION MANUAL.

Relieve Hydraulic Tank Pressure

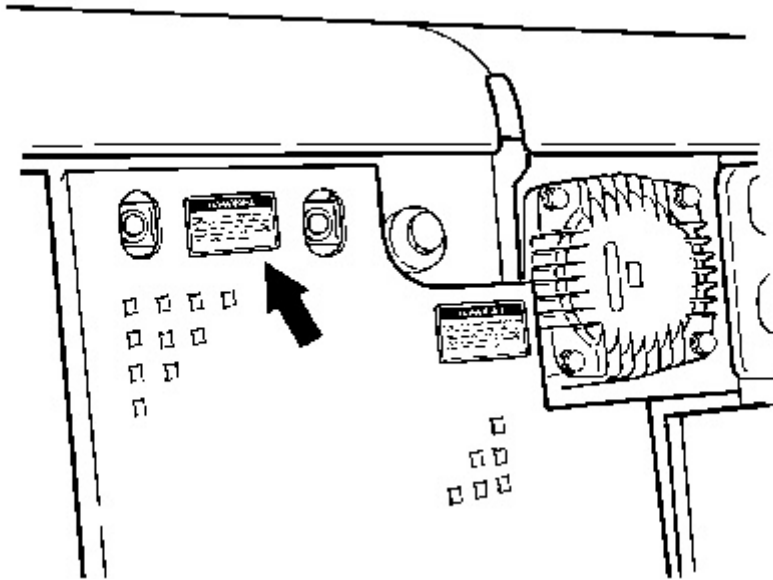

Illustration 5

g00683820

This safety message is located on the top of the hydraulic tank.





HYDRAULIC TANK

RELIEVE TANK PRESSURE WITH ENGINE OFF BY REMOVING CAP SLOWLY TO PREVENT BURNS FROM HOT OIL.

Lift Eyes Can Fail

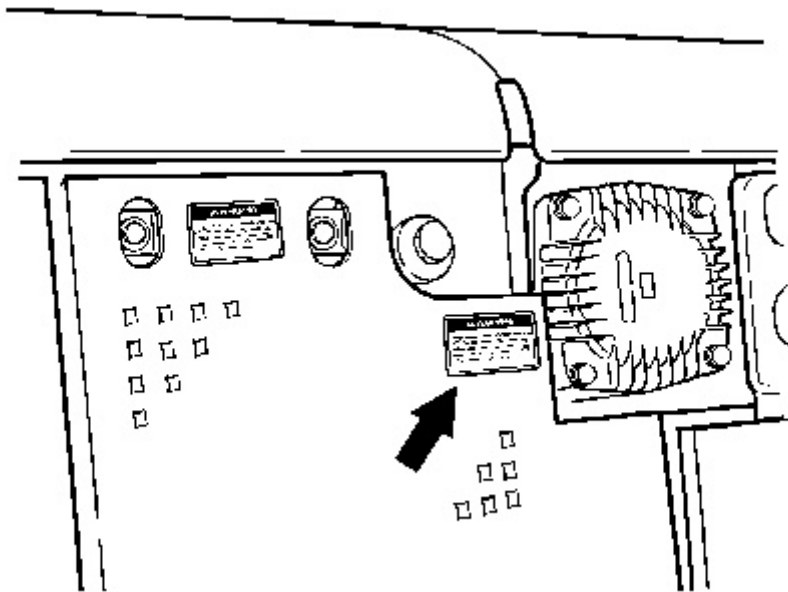
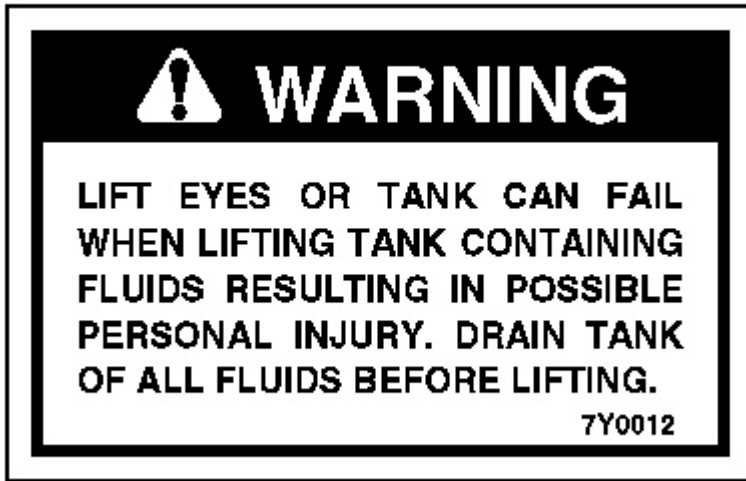

Illustration 6

g00683821

This safety message is located on the top of the hydraulic tank and the fuel tank.



g00100728



LIFT EYES OR TANK CAN FAIL WHEN LIFTING TANK CONTAINING FLUIDS RESULTING IN POSSIBLE PERSONAL INJURY. DRAIN TANK OF ALL FLUIDS BEFORE LIFTING.

High Pressure Gas

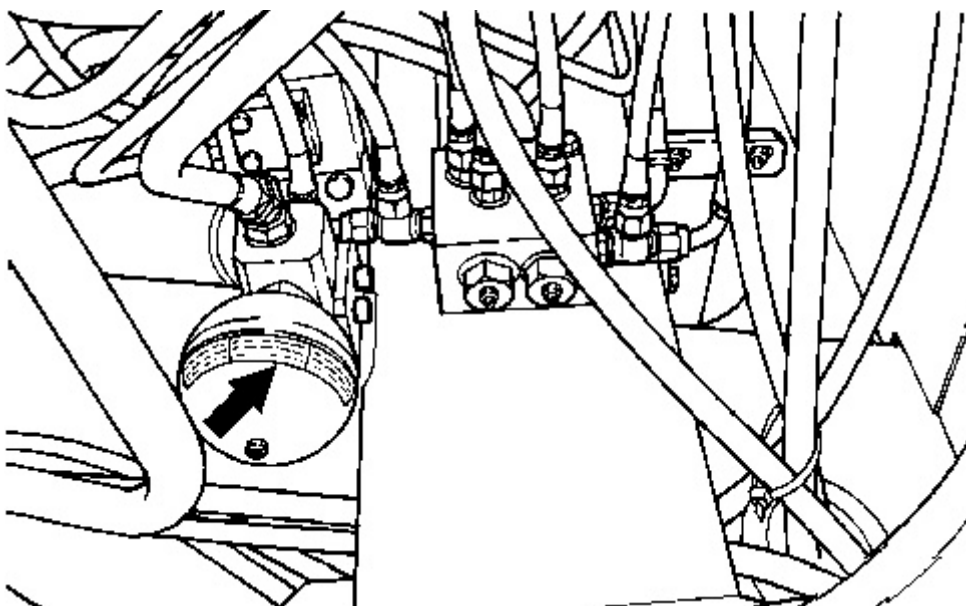

This safety message is located on the accumulator.



This system contains high pressure gas. Failure to follow the instructions and warnings could cause an explosion, resulting in possible injury or death.

Do not expose to fire. Do not weld. Do not drill. Relieve pressure before discharging.

See Operation and Maintenance Manual for charging and discharging. See your Caterpillar Dealer for tools and detailed information.

High Pressure Cylinder

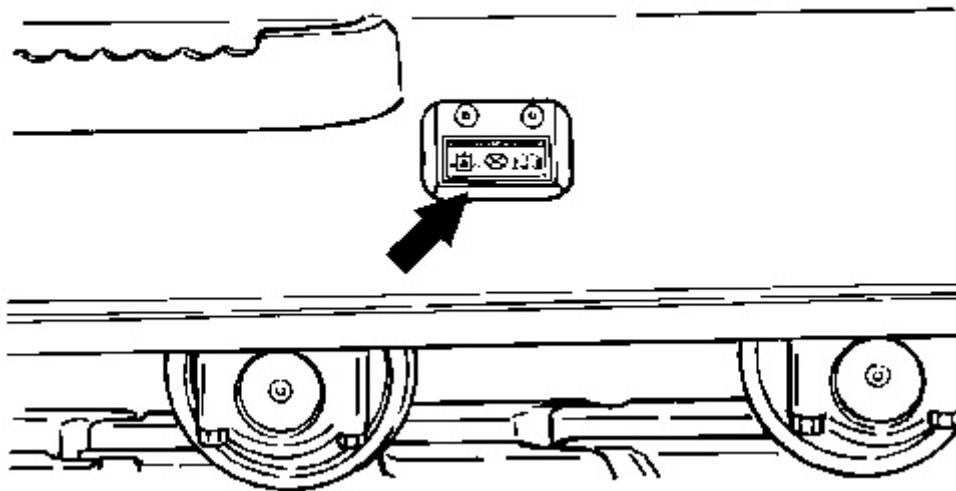
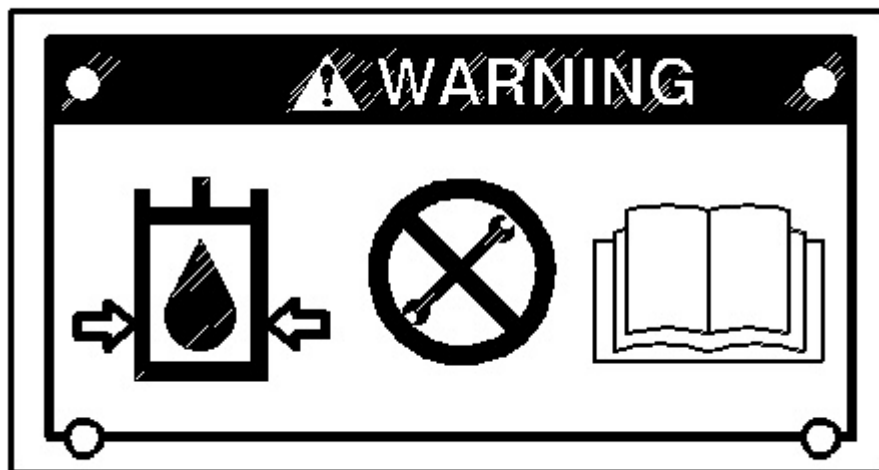

Illustration 8

g00684454

This safety message is located on the track adjuster.



g00100742

 **WARNING**

High Pressure Cylinder. Do not remove any parts from the cylinder until all of the pressure has been relieved. This will prevent possible personal injury or death.

Refer to Operation and Maintenance Manual, "Track Adjustment - Adjust" for the proper service procedure.

Aerosol Starting Aid

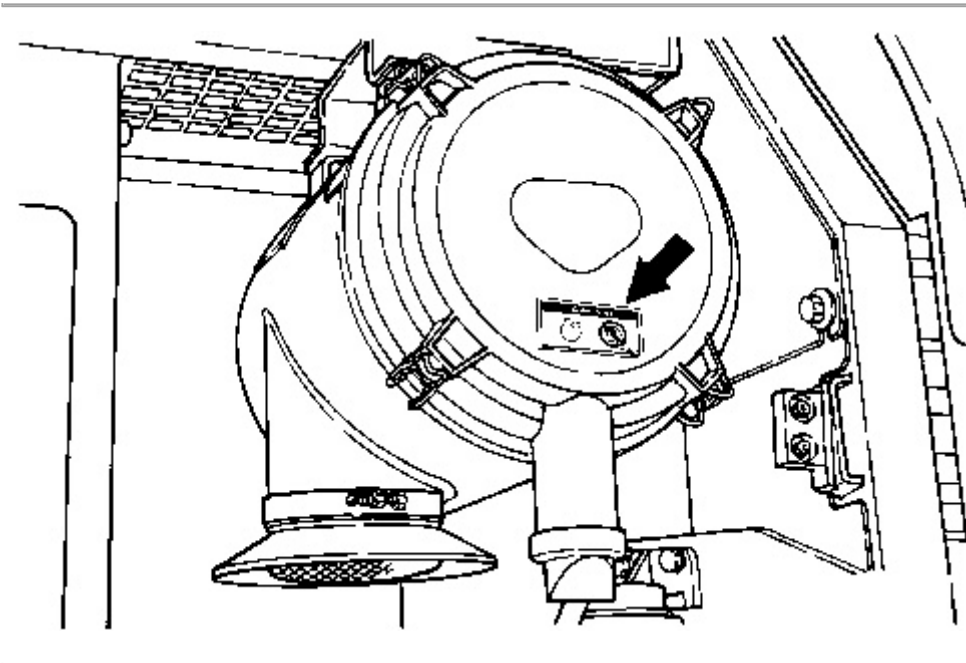

Illustration 9

g00683823

This safety message is located on the cover of intake duct of the air cleaner.



g00100745



WARNING

Explosion hazard! Do not use ether! This machine is equipped with an air inlet heater. Using ether can create explosions or fires that can cause personal injury or death. Read and follow the starting procedure in the Operation and Maintenance Manual.

Refer to Operation and Maintenance Manual, "Engine Starting" for further information.

Automatic Engine Speed Control (AEC)

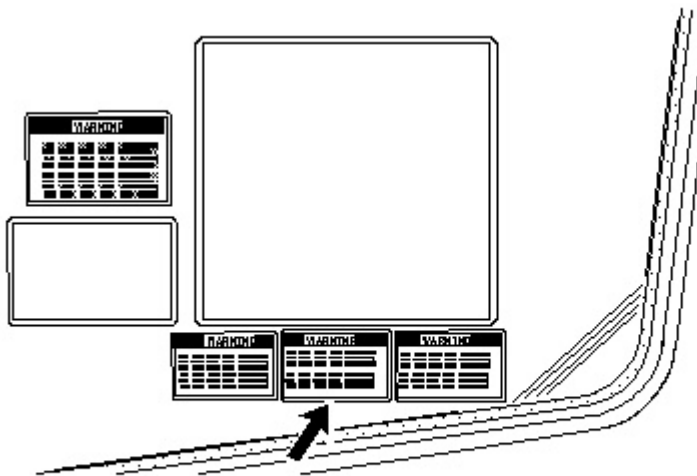

Illustration 10

g00103449

This safety message is located in the cab.

 **WARNING**

AUTOMATIC ENGINE SPEED CONTROL (AEC) WILL INCREASE ENGINE SPEED AUTOMATICALLY WHEN YOU OPERATE THE CONTROL LEVER(S) AND/OR TRAVEL PEDALS WITH AEC SWITCH ON.

WHEN LOADING AND UNLOADING MACHINE FROM TRUCK OR WORKING IN CLOSE QUARTERS ALWAYS TURN OFF AEC SWITCH TO PREVENT ANY POSSIBILITY OF SUDDEN MOVEMENT OF MACHINE, WHICH COULD RESULT IN SERIOUS INJURY OR DEATH.

7Y0005 2

g00100749

 **WARNING**

AUTOMATIC ENGINE SPEED CONTROL (AEC) WILL INCREASE ENGINE SPEED AUTOMATICALLY WHEN YOU OPERATE THE CONTROL LEVER(S) AND/OR TRAVEL PEDALS WITH AEC SWITCH ON.

WHEN LOADING AND UNLOADING MACHINE FROM TRUCK OR WORKING IN CLOSE QUARTERS ALWAYS TURN OFF AEC SWITCH TO PREVENT ANY POSSIBILITY OF SUDDEN MOVEMENT OF MACHINE, WHICH COULD RESULT IN SERIOUS INJURY OR DEATH.

Travel Speed Control Switch

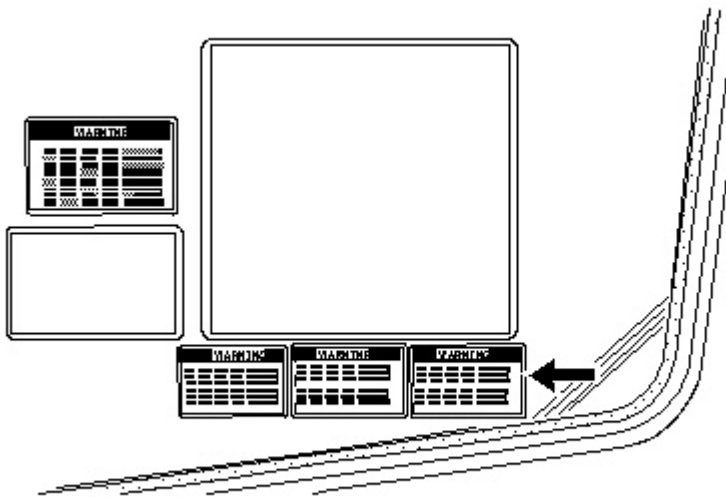
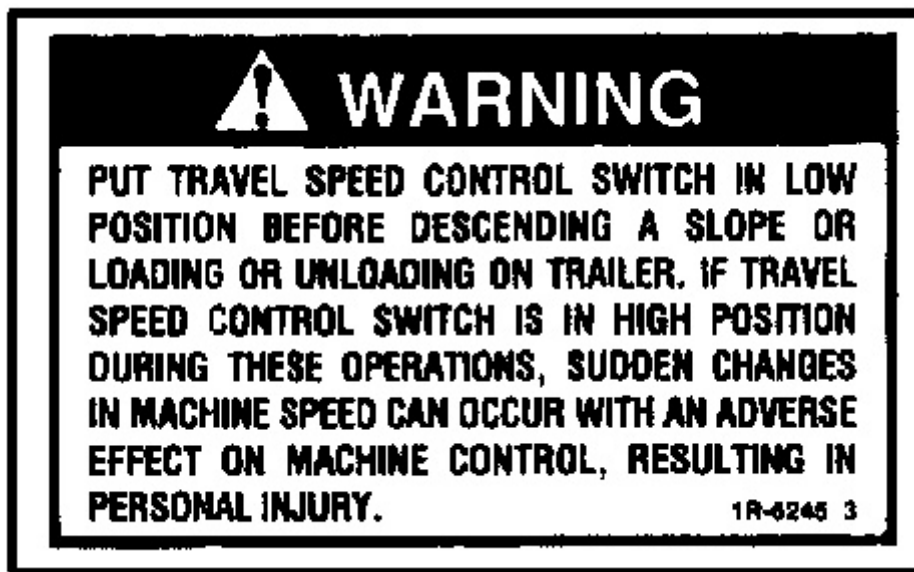

Illustration 11

g00103451

This safety message is located in the cab.



g00529024



PUT TRAVEL SPEED CONTROL SWITCH IN LOW POSITION BEFORE DESCENDING A SLOPE OR LOADING OR UNLOADING ON TRAILER. IF TRAVEL SPEED CONTROL SWITCH IS IN HIGH POSITION DURING THESE OPERATIONS, SUDDEN CHANGES IN MACHINE SPEED CAN OCCUR WITH AN



Suggest:

For more complete manuals. Please go to the home page.

<https://www.ebooklibonline.com>

If the above button click is invalid. Please download this document first, and then click the above link to download the complete manual.

Thank you so much for reading

ADVERSE EFFECT ON MACHINE CONTROL, RESULTING IN PERSONAL INJURY.

Pressurized System

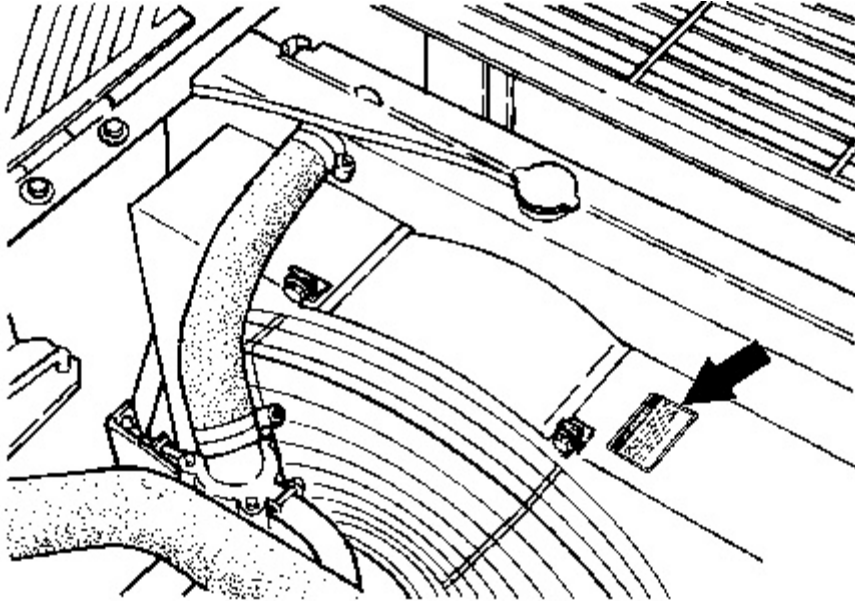
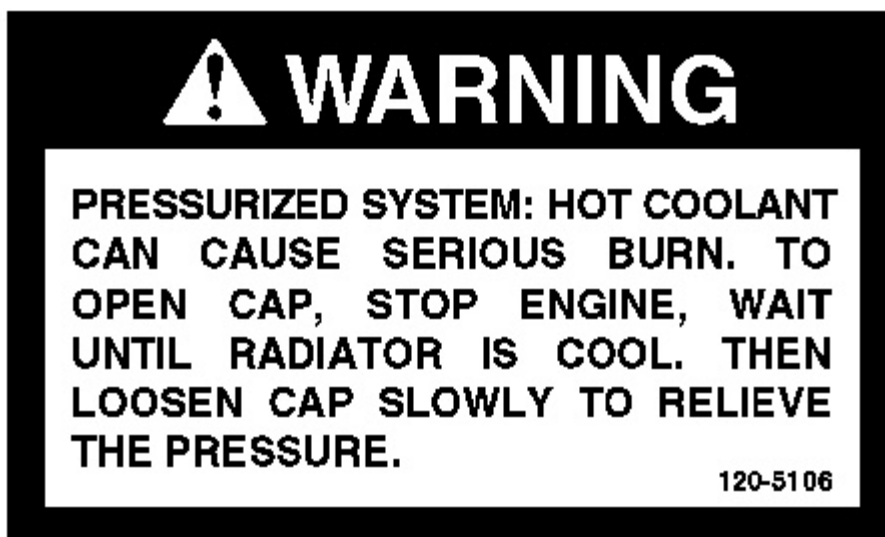

Illustration 12

g00683824

This safety message is located on the radiator.



g00100763



WARNING

PRESSURIZED SYSTEM: HOT COOLANT CAN CAUSE SERIOUS BURN. TO OPEN CAP, STOP ENGINE, WAIT UNTIL RADIATOR IS COOL. THEN LOOSEN CAP SLOWLY TO RELIEVE THE PRESSURE.

Changes To Machine Control Pattern

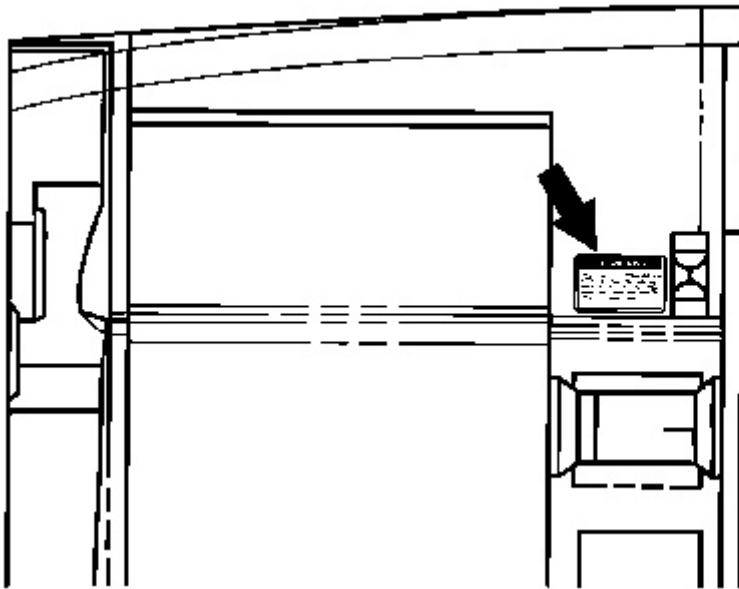

Illustration 13

g00683826

This safety message is located on the left access door if the machine is equipped with a two-way valve or a four-way valve.

<https://www.ebooklibonline.com>

Hello dear friend!

Thank you very much for reading.

Enter the link into your browser.

The full manual is available for immediate download.

<https://www.ebooklibonline.com>