

Product: EXCAVATOR

Model: 320 GC EXCAVATOR BR4

Configuration: 320 GC Excavator BR400001-UP (MACHINE) POWERED BY C4.4 Engine

## Operation and Maintenance Manual 320 GC, 320 and 323 Excavator

Media Number -M0083583-05

Publication Date -01/09/2015

Date Updated -17/05/2018

s03548206

## Foreword

### California Proposition 65 Warning

**Diesel engine exhaust and some of its constituents are known to the State of California to cause cancer, birth defects, and other reproductive harm.**



**WARNING** - This product can expose you to chemicals including ethylene glycol, which is known to the State of California to cause birth defects or other reproductive harm. For more information go to:

[www.P65Warnings.ca.gov](http://www.P65Warnings.ca.gov)

**Do not ingest this chemical. Wash hands after handling to avoid incidental ingestion.**



**WARNING** - This product can expose you to chemicals including lead and lead compounds, which are known to the State of California to cause cancer, birth defects, or other reproductive harm. For more information go to:

[www.P65Warnings.ca.gov](http://www.P65Warnings.ca.gov)

**Wash hands after handling components that may contain lead.**

## Literature Information

This manual should be stored in the operator's compartment in the literature holder or seat back literature storage area.

This manual contains safety information, operation instructions, transportation information, lubrication information, and maintenance information.

Some photographs or illustrations in this publication show details or attachments that can be different from your machine. Guards and covers might have been removed for illustrative purposes.

Continuing improvement and advancement of product design might have caused changes to your machine which are not included in this publication. Read, study, and keep this manual with the machine.

Whenever a question arises regarding your machine, or this publication, please consult your Cat dealer for the latest available information.

## **Safety**

The safety section lists basic safety precautions. In addition, this section identifies the text and locations of warning signs and labels used on the machine.

Read and understand the basic precautions listed in the safety section before operating or performing lubrication, maintenance, and repair on this machine.

## **Operation**

The operation section is a reference for the new operator and a refresher for the experienced operator. This section includes a discussion of gauges, switches, machine controls, attachment controls, transportation, and towing information.

Photographs and illustrations guide the operator through correct procedures of checking, starting, operating, and stopping the machine.

Operating techniques outlined in this publication are basic. Skill and techniques develop as the operator gains knowledge of the machine and its capabilities.

## **Maintenance**

The maintenance section is a guide to equipment care. The Maintenance Interval Schedule (MIS) lists the items to be maintained at a specific service interval. Items without specific intervals are listed under the "When Required" service interval. The Maintenance Interval Schedule lists the page number for the step-by-step instructions required to accomplish the scheduled maintenance. Use the Maintenance Interval Schedule as an index or "one safe source" for all maintenance procedures.

### **Maintenance Intervals**

Use the service hour meter to determine servicing intervals. Calendar intervals shown (daily, weekly, monthly, etc.) can be used instead of service hour meter intervals if the calendar intervals

provide more convenient servicing schedules and approximate the indicated service hour meter reading. Perform the recommended service at the interval that occurs first.

Under severe, dusty, or wet operating conditions, more frequent lubrication than is specified in the maintenance intervals chart might be necessary.

Perform service on items at multiples of the original requirement. For example, at every 500 service hours or 3 months, also service those items listed under every 250 service hours or monthly and every 10 service hours or daily.

## Certified Engine Maintenance

Proper maintenance and repair are essential to keep the engine and machine systems operating correctly. As the heavy-duty off-road diesel engine owner, you are responsible for the performance of the required maintenance listed in the Owner Manual, Operation and Maintenance Manual, and Service Manual.

It is prohibited for any person engaged in the business of repairing, servicing, selling, leasing, or trading engines or machines to remove, alter, or to render inoperative, any emission-related device or element of design installed on or in an engine or machine that is in compliance with all applicable regulations of the intended country to which it has been shipped. Certain elements of the machine and engine such as the exhaust system, fuel system, electrical system, intake air system, and cooling system may be emission-related and should not be altered unless approved by Caterpillar.

## Machine Capacity

Additional attachments or modifications may exceed machine design capacity which can adversely affect performance characteristics. Included would be stability and system certifications such as brakes, steering, and rollover protective structures (ROPS). Contact your Cat dealer for further information.

## Product Identification Number

Effective First Quarter 2001 the Product Identification Number (PIN) has changed from 8 to 17 characters. To provide uniform equipment identification, construction equipment manufacturers are moving to comply with the latest version of the product identification numbering standard. Non-road machine PINs are defined by ISO 10261. The new PIN format will apply to all machines and generator sets. The PIN plates and frame marking will display the 17 character PIN. The new format will look like the following:



**<https://www.ebooklibonline.com>**

Hello dear friend!

Thank you very much for reading.

Enter the link into your browser.

The full manual is available for immediate download.

**<https://www.ebooklibonline.com>**

Where:

1. World Manufacturing Code (characters 1-3)
2. Machine Descriptor (characters 4-8)
3. Check Character (character 9)
4. Machine Indicator Section (MIS) or Product Sequence Number (characters 10-17). These were previously referred to as the Serial Number.

Machines and generator sets produced before First Quarter 2001 will maintain their 8 character PIN format.

Components such as engines, transmissions, axles, and work tools will continue to use an 8 character Serial Number (S/N).

---

Product: EXCAVATOR

Model: 320 GC EXCAVATOR BR4

Configuration: 320 GC Excavator BR400001-UP (MACHINE) POWERED BY C4.4 Engine

## **Operation and Maintenance Manual**

### **320 GC, 320 and 323 Excavator**

Media Number -M0083583-05

Publication Date -01/09/2015

Date Updated -17/05/2018

i07503031

## **Safety Messages**

SMCS - 7000; 7405

There are several specific safety messages on this machine. The exact location of the hazards and the description of the hazards are reviewed in this section. Please become familiarized with all safety messages.

Make sure that all the safety messages are legible. Clean the safety messages or replace the safety messages if you cannot read the words. Replace the illustrations if the illustrations are not visible. When you clean the safety messages, use a cloth, water, and soap. Do not use solvent, gasoline, or other harsh chemicals to clean the safety messages. Solvents, gasoline, or harsh chemicals could loosen the adhesive that secures the safety message. Loose adhesive will allow the safety message to fall.

Replace any safety message that is damaged, or missing. If a safety message is attached to a part that is replaced, install a safety message on the replacement part. Any Cat dealer can provide new safety messages.

---

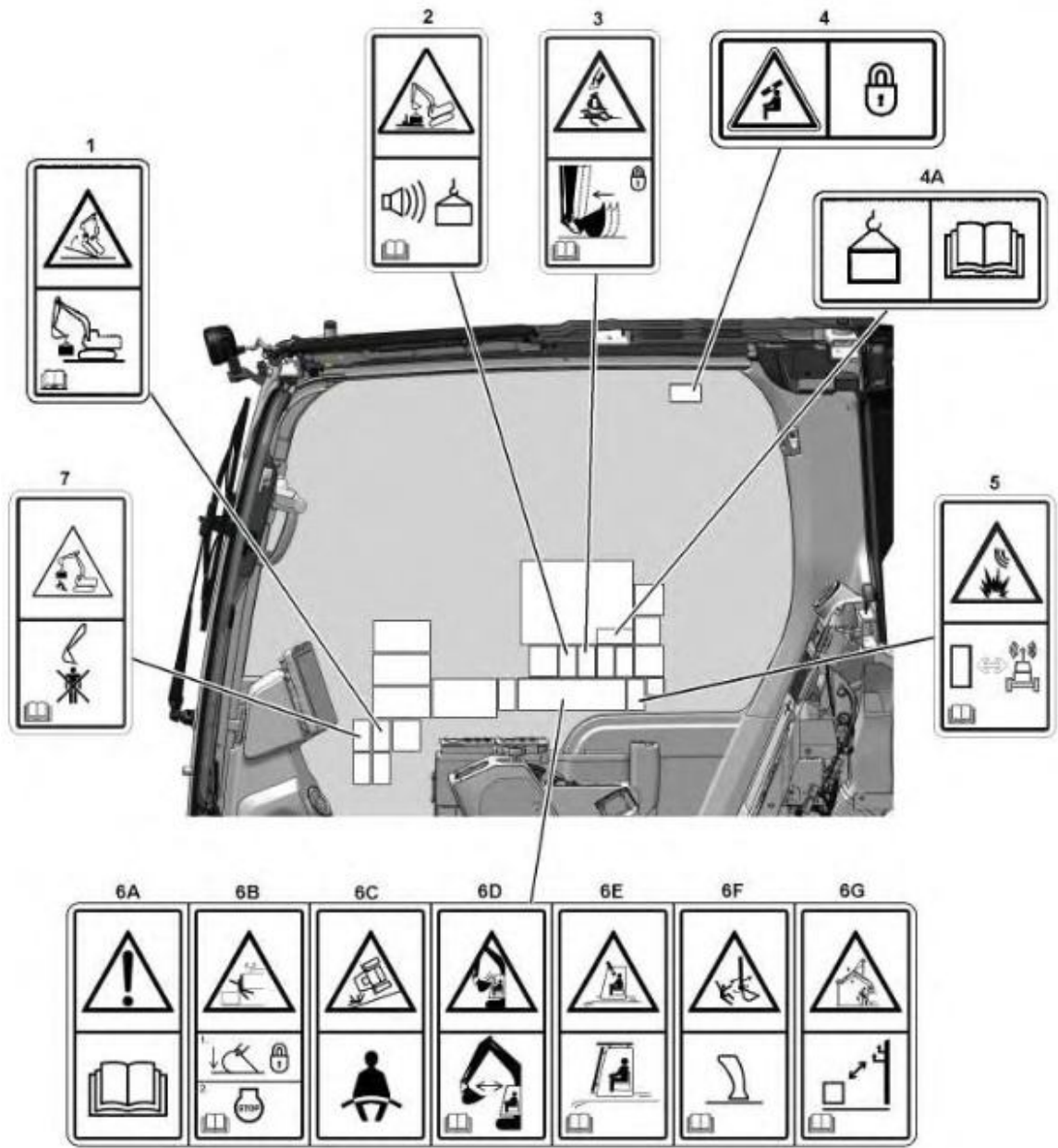
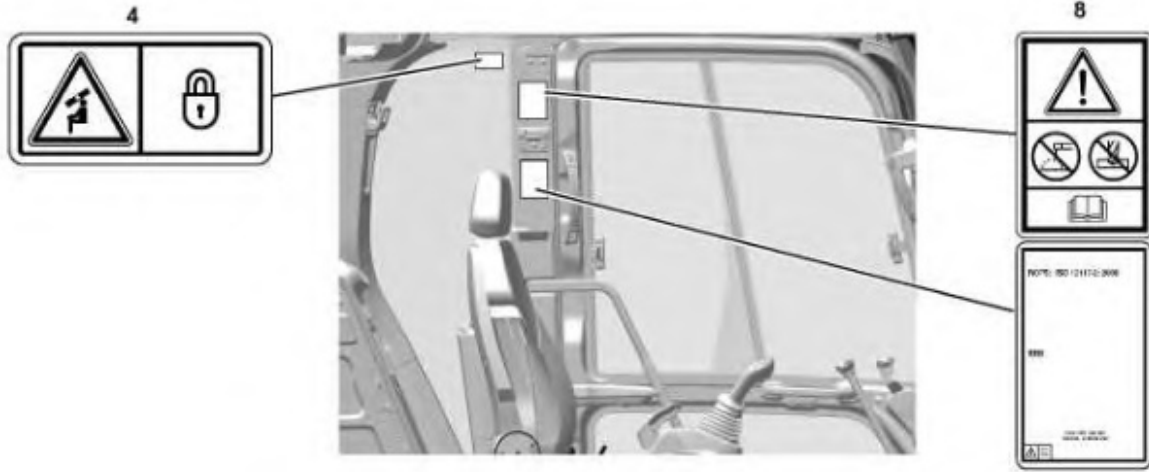

Illustration 1

g06289476



---

Illustration 2

g06188729

---

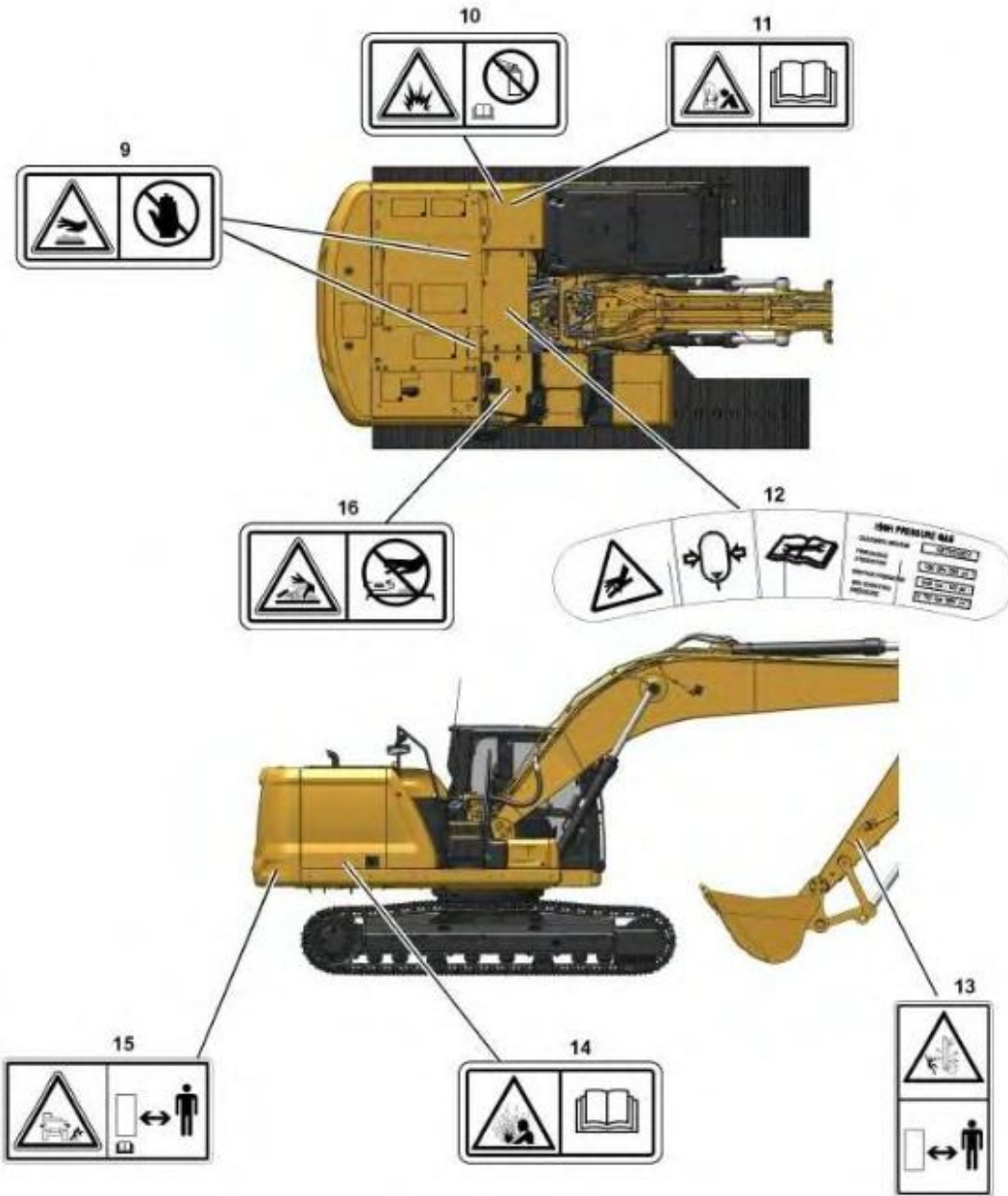

Illustration 3

g06180922



Illustration 4

g06184325

## Lifting Level Warning (1)

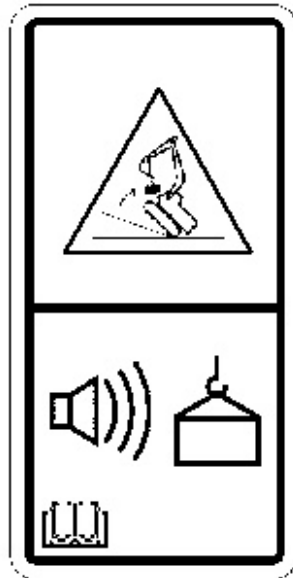

Illustration 5

g06188532

## Overload Warning Device (2)

If equipped, this safety message is located in the cab on the right side window.

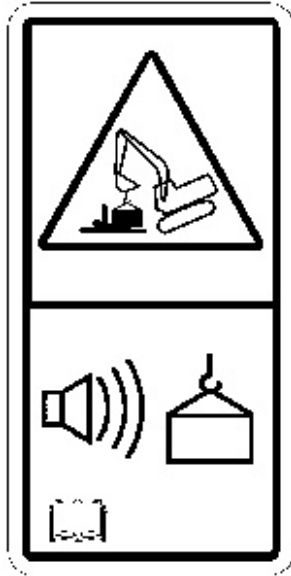

Illustration 6

g06224998



**Overloading the machine could impact the machine's stability which could result in a tipover hazard. A tipover hazard could result in serious injury or death. Always activate the overload warning device before you handle or lift objects.**

Refer to Operation and Maintenance Manual, "Operator Controls" for further information.

### **Crushing Injury (3)**

If equipped, this safety message is located in the cab on the right side window.

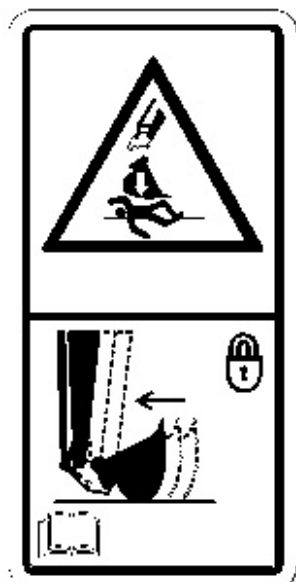



**Crush injury. Could cause serious injury or death. Always confirm that the quick coupler is engaged onto the pins. Read the Operator's Manual.**

---

Refer to Operation and Maintenance Manual, "Quick Coupler Operation" for further information.

**Crushing Hazard (4)**

These safety messages are on the left and right side cab windows.

---

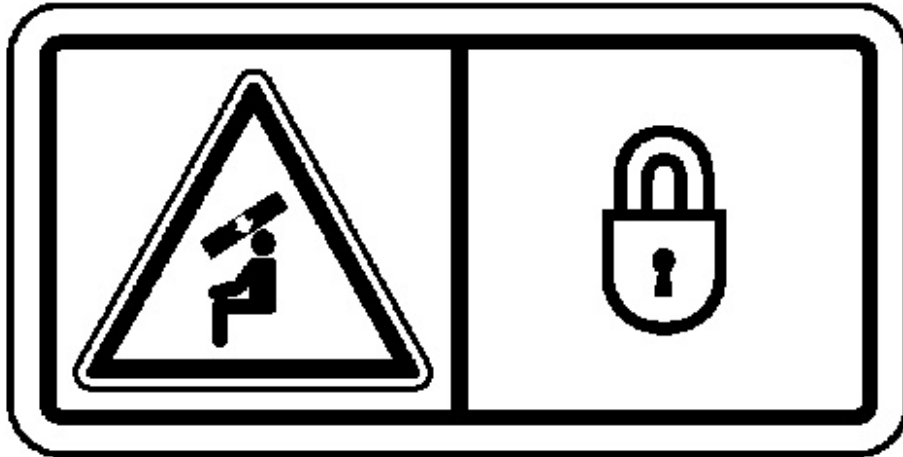

**Personal injury can result if the window is not latched in the overhead position; ensure the auto lock is engaged.**

---

Refer to Operation and Maintenance Manual, "Window (Front)" for further information.

**Lifting Notice (4A)**

If equipped, this safety message is located in the cab on the right side window.

---

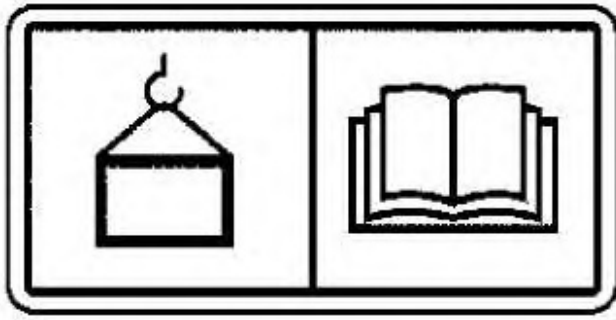

Illustration 9

g06289554



**When operating the machine's lift tool, read Operation and Maintenance Manual first for lifting capabilities.**

### Product Link (5)

If equipped, this safety message is located in the cab on the right side window.

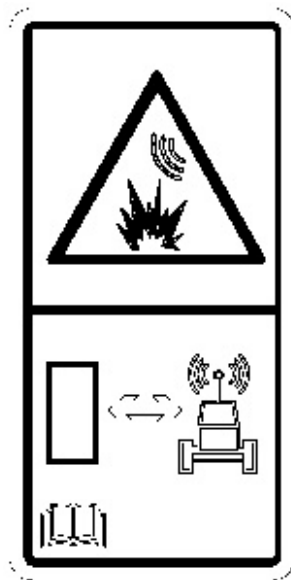

Illustration 10

g06188657



**This machine is equipped with a Caterpillar Product Link communication device. When electric detonators are used, this communication device should be deactivated within 12 m (40 ft) of a blast site for satellite-based systems and within 3 m (10 ft) of a blast site for cellular based systems, or within the distance mandated under applicable legal requirements. Failure to do so could cause interference with blasting operations and result in serious injury or death.**

**In cases where the type of Product Link module cannot be identified, Caterpillar recommends that the device be disabled no less than 12 m (40 ft) from the blast perimeter.**

---

Refer to Operation and Maintenance Manual, "Product Link" for further information.

### **Do Not Operate (6A)**

This safety message is located in the cab on the right side window.

---

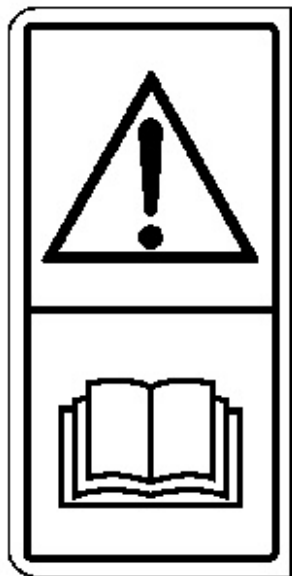

Illustration 11

g06188661



**Do not operate or work on this machine unless you have read and understand the instructions and warnings in the Operation and Maintenance Manual. Failure to follow the instructions or heed the warnings could result in injury or death. Contact any Caterpillar dealer for replacement manuals. Proper care is your responsibility.**

---

### **Crushing Hazard (6B)**

If equipped, this safety message is located in the cab on the right side window.

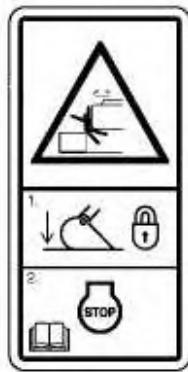

Illustration 12

g02282255



**Crush Hazard! A machine may move unexpectedly and without warning resulting in personal injury or death.**

**Before leaving the machine lower the work tool to the ground, lock operator controls, shut off the engine and remove the key.**

---

### Seat Belt (6C)

This safety message is located in the cab on the right side window.



Illustration 13

g06188642



**A seat belt should be worn at all times during machine operation to prevent serious injury or death in the event of an accident or machine overturn. Failure to wear a seat belt during machine operation may result in serious injury or death.**

---

### **Crushing Hazard (6D)**

This safety message is located in the cab on the right side window.

---

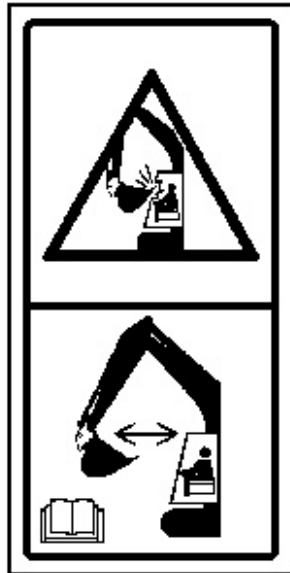

Illustration 14

g06188644

 **WARNING**

**Crushing Hazard! Certain machine front linkage combinations (boom, stick, quick coupler, work tool) may require keeping the work tool away from the cab during operation. Personal injury or death may result if the work tool contacts the cab during operation.**

---

### **Crushing Hazard (6E)**

This safety message is located in the cab on the right side window.

---

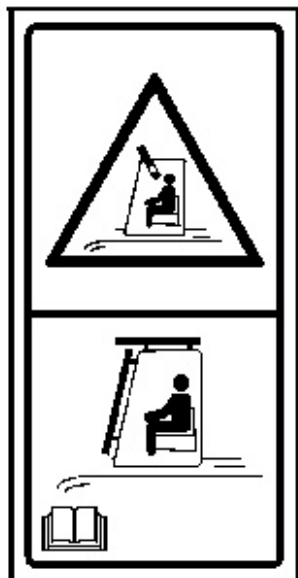

---

Illustration 15

g06188652

 **WARNING**

**The impact from objects that strike the front of the cab or the top of the cab could result in a crushing hazard with the potential for personal injury or death.**

**The front guard and the top guard should be installed on the cab for applications where the hazard of falling objects exist. Read the Operation and Maintenance Manual.**

---

Refer to Operation and Maintenance Manual, "Guards" for further information.

**Joystick Controls Alternate Patterns (6F)**

If equipped, this safety message is located in the cab on the right side window.

---

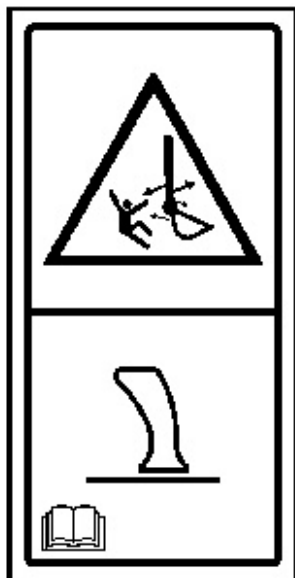

---

Illustration 16

g06188665

 **WARNING**

**Crush Hazard. Improper joystick setting could cause possible unexpected movement of the boom, stick, or worktool which could result in serious injury or death. Confirm that the joystick settings are properly configured before you operate the machine. Read the Operation and Maintenance Manual.**

---

Refer to Operation and Maintenance Manual, "Joystick Controls Alternate Patterns" for further information.

## **Electrical Power Lines (6G)**

This safety message is located in the cab.

---

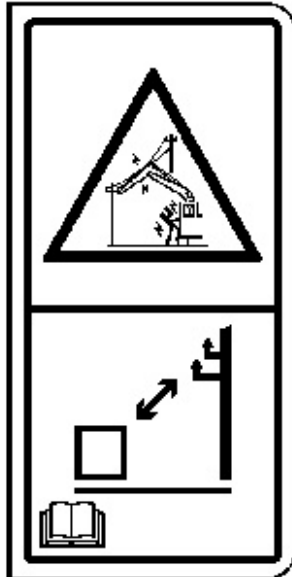

---

Illustration 17

g06188667

 **DANGER**

**Electrocution Hazard! Keep the machine and attachments a safe distance from electrical power. Stay clear 3 m (10 ft) plus twice the line insulator length. Read and understand the instructions and warnings in the Operation and Maintenance Manual. Failure to follow the instructions and warnings will cause serious injury or death**

---

Refer to Operation and Maintenance Manual, "Specifications" for further information.

## **Do Not Lift Over Personnel (7)**

This safety message is located in the cab on the right side window.

---

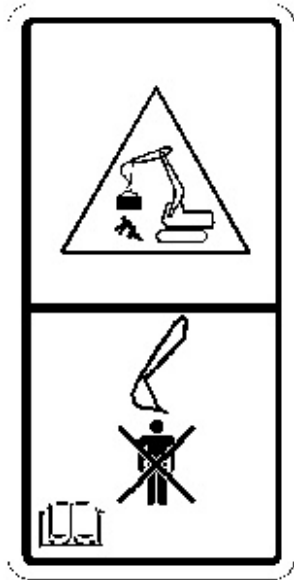

Illustration 18

g06188697

Do not lift

**Do Not Weld or Drill on ROPS (8)**

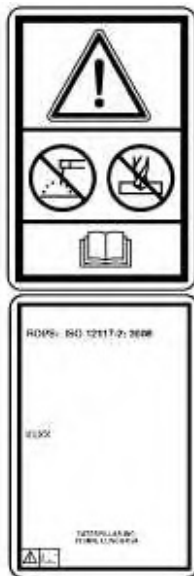

Illustration 19

g06207749

If equipped, this safety message is on the left side pillar in the cab.



**Structural damage, an overturn, modification, alteration, or improper repair, can impair this structure's protective capability thereby voiding this certification. Do not weld on or drill holes in the structure. Consult**



**Suggest:**

**For more complete manuals. Please go to the home page.**

**<https://www.ebooklibonline.com>**

**If the above button click is invalid. Please download this document first, and then click the above link to download the complete manual.**

**Thank you so much for reading**

**a Caterpillar dealer to determine this structure's limitations without voiding its certification.**

---

This machine has been certified to the standards that are listed on the certification plate. The maximum mass of the machine, which includes the operator and the attachments without a payload, should not exceed the mass on the certification plate.

Refer to Operation and Maintenance Manual, "Guards (Operator Protection)" for more information.

### **Hot Surface (9)**

This message is on the outside of the engine hood and on the inside of the engine hood.

---



Illustration 20

g01372256

 **WARNING**

**Engine hood and engine hood parts can be hot while engine is running or immediately after engine shutdown. Hot parts or hot components can cause burns or personal injury. Do not allow these parts to contact your skin, when engine is running or immediately after engine shutdown. Use protective clothing or protective equipment to protect your skin.**

---

### **Aerosol Starting Aid (10)**

This safety message is located near the precleaner. The following information is not applicable to machines that are equipped with an ether starting aid.

---



Illustration 21

g01372254

**! WARNING**

**Explosion hazard! Do not use ether! This machine is equipped with an air inlet heater. Using ether can create explosions or fires that can cause personal injury or death. Read and follow the starting procedure in the Operation and Maintenance Manual.**

Refer to Operation and Maintenance Manual, "Engine Starting" for the proper starting procedure.

**Jump-Start Cables (11)**

This safety message is positioned on the circuit breaker panel.

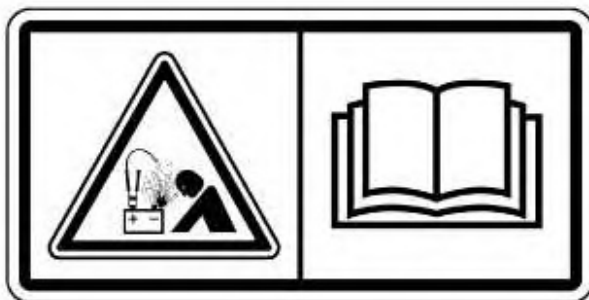

Illustration 22

g01370909

**! WARNING**

**Explosion Hazard! Improper jumper cable connections can cause an explosion resulting in serious injury or death. Batteries may be located**

**<https://www.ebooklibonline.com>**

Hello dear friend!

Thank you very much for reading.

Enter the link into your browser.

The full manual is available for immediate download.

**<https://www.ebooklibonline.com>**