

Product: TRACK-TYPE TRACTOR

Model: D4D TRACK-TYPE TRACTOR 44H

Configuration: D4D TRACTOR 44H01189-01190 (MACHINE) POWERED BY 3304 ENGINE

Disassembly and Assembly D4 TRACTOR ENGINE

Media Number -REG00890-01

Publication Date -01/05/1974

Date Updated -10/10/2001

Governor (Later Model Sleeve Metering Fuel System)

SMCS - 1264-15; 1264-16

Disassemble Governor (Later Model Sleeve Metering Fuel System)

start by:

a) separation of governor from fuel injection pump housing

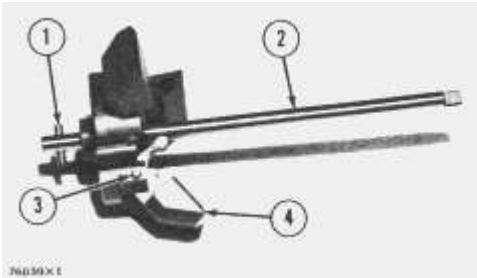

1. Remove shaft (2). Remove pin (1) from the shaft.
2. Remove pins (3) from the flyweights. Remove flyweights (4).

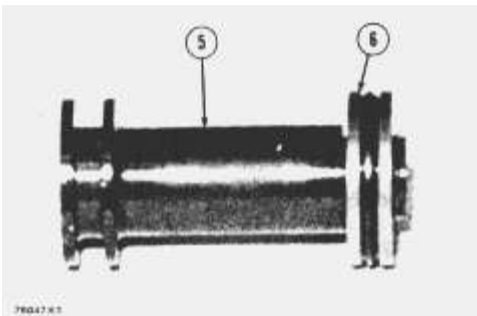

3. Remove ring, races (6) and bearings from the riser (follower) (5).

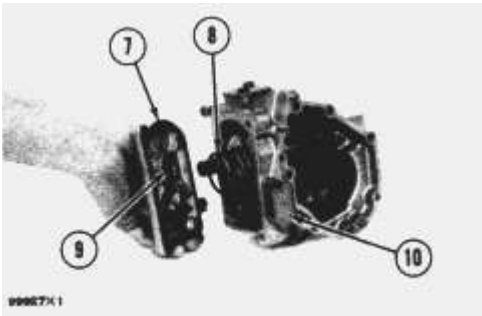

NOTE: There is a force on the cover (7) from the spring (8).

4. Remove cover (7) and spring (8) from the governor housing.
5. Remove seal (9) from the cover.
6. Remove cover (10) for the low and high idle adjustments.

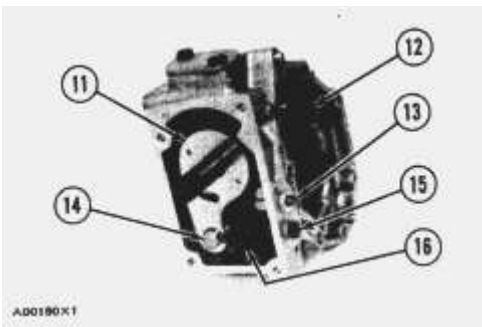

7. Remove locknut and screw (13) for the high idle adjustment.
8. Remove bolt (15) and washers for the low idle adjustment.
9. Remove spring (16) and guide.
10. Remove pin (14) and plate (11).
11. Remove shaft (12) from the housing.

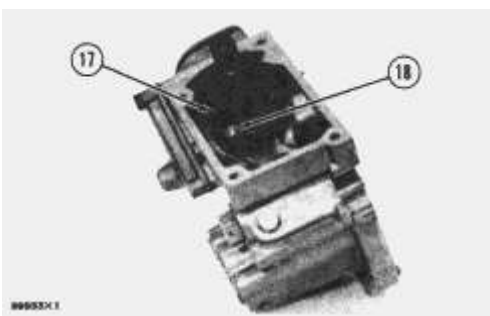

12. Remove pin (18) and two spacers (17) from the shaft.

NOTE: Earlier model sleeve metering fuel systems have a ball in place of spacers (17) and pin (18).

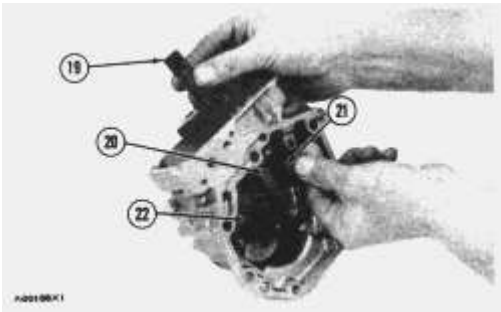

13. Remove shaft (19) from the governor housing.

14. Remove washer (20) and levers (21) and (22) from the governor housing.

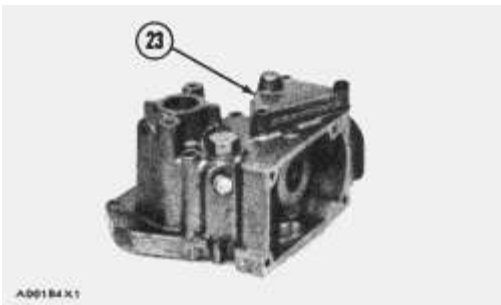

15. Remove cover (23) from the governor housing.

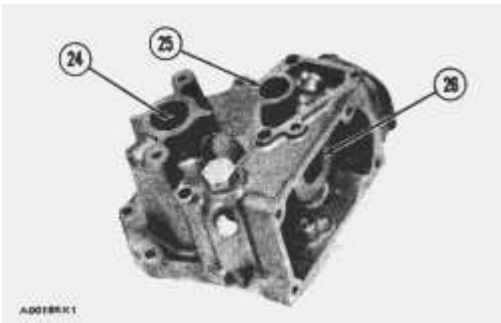

16. Remove seal (25) and bearing.

17. Remove seals (24) and (26) from the governor housing.

Assemble Governor (Later Sleeve Metering Fuel System)

Tools Needed		A	B
1P529	Handle	1	1
1P471	Drive Plate		1
1P457	Drive Plate		1

<https://www.ebooklibonline.com>

Hello dear friend!

Thank you very much for reading.

Enter the link into your browser.

The full manual is available for immediate download.

<https://www.ebooklibonline.com>

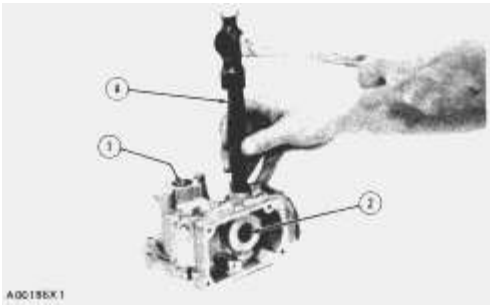

1. Install the bearing and seal in the housing with tool (A). The lip of the seal must be toward the bearing.
2. Install seal (1) in the housing with tool (A). The lip of the seal must be toward the inside of the housing.
3. Install seal (2) in the housing with tooling (B). The lip of the seal must be toward the inside of the housing.

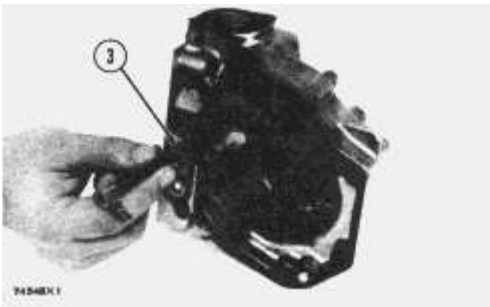

4. Install shaft (3) in the housing.

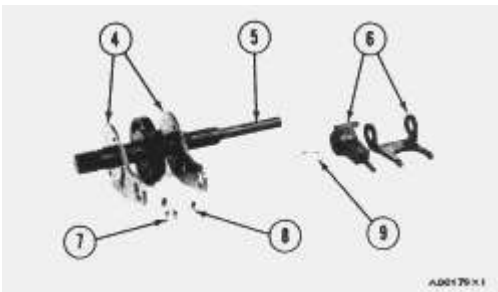

5. Install plates (4), spacers (8) and pin (7) on the shaft.
6. Install shaft (5) in the housing and through washer (9) and levers (6).

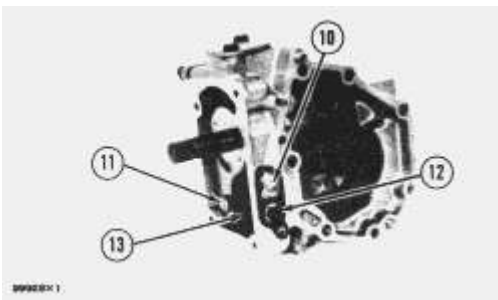

7. Install pin (11) in holes of the plates.

8. Install screw (10) and locknut for high idle adjustment.
9. Install spring (13) and guide.
10. Install bolts (12) and washer for low idle adjustment.
11. Push plate and pin (11) over toward bolt (12) and tighten the bolt.
12. Install the seal in the cover with tooling (B). The lip of the seal must be toward the inside.

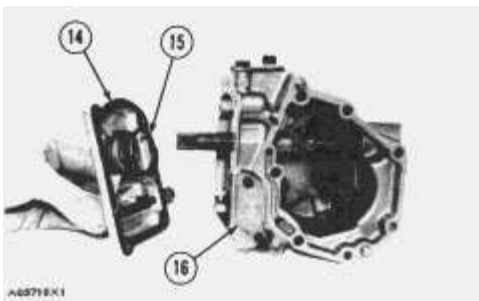

13. Install spring (15) in the cover.

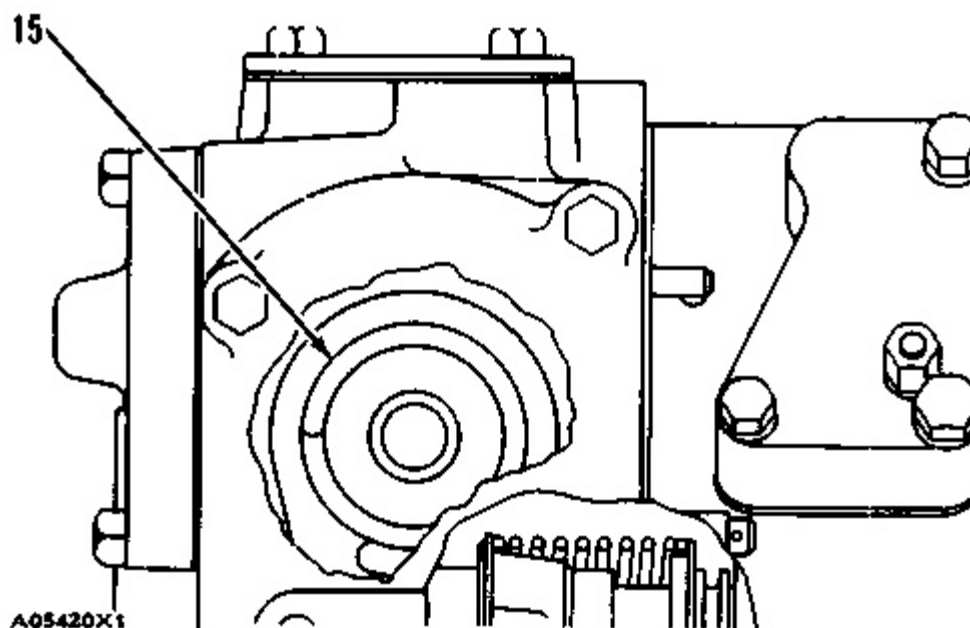

NOTICE

The spring (15) must be installed with the end of the spring as shown.

14. Install the cover (16) for the idle adjustment screws.

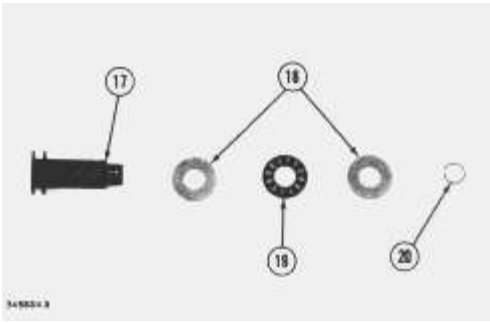

15. Install bearing (19) between races (18) on riser (follower) (17). Install ring (20) that holds the washer on the riser (follower).

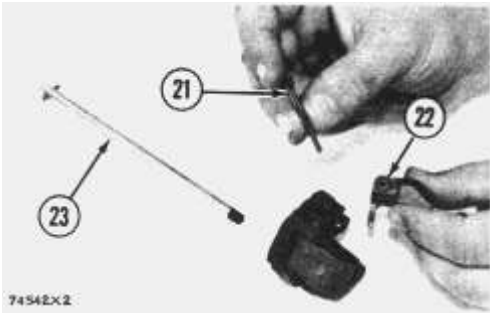

16. Install pin in shaft (23).

17. Install flyweights (22) and pin (21).

18. Install shaft (23) in flyweight assembly.

end by:

a) connection of governor to fuel injection pump housing

Product: TRACK-TYPE TRACTOR

Model: D4D TRACK-TYPE TRACTOR 44H

Configuration: D4D TRACTOR 44H01189-01190 (MACHINE) POWERED BY 3304 ENGINE

Disassembly and Assembly D4 TRACTOR ENGINE

Media Number -REG00890-01

Publication Date -01/05/1974

Date Updated -10/10/2001

Fuel Transfer Pump (Later Model Sleeve Metering Fuel System)

SMCS - 1256-11; 1256-12

Remove Fuel Transfer Pump (Later Model Sleeve Metering Fuel System)

Tools Needed		A	B
2P8315	Bracket Assembly	1	
2H3740	Bolt		1

1. Put the fuel injection pump housing on tool (A).

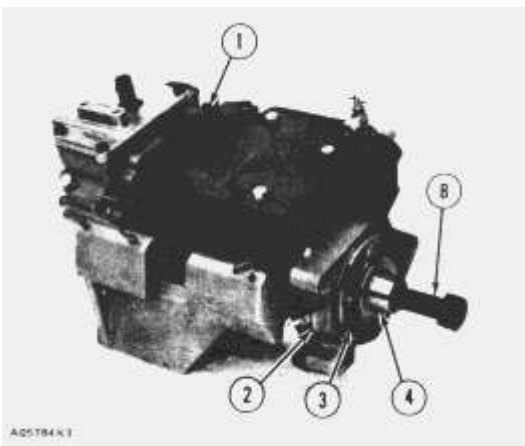

2. Install timing pin (1) to keep the injection pump camshaft from turning during disassembly and assembly.
 3. Install bolt (B) in the threads of sleeve (4). Tighten the bolt until the sleeve can be removed.
-

NOTICE

Do not hit the bolt or sleeve. This will cause damage to the unit.

4. Remove bolts (3) that hold the body to the housing.
5. Remove body (2) from the housing.

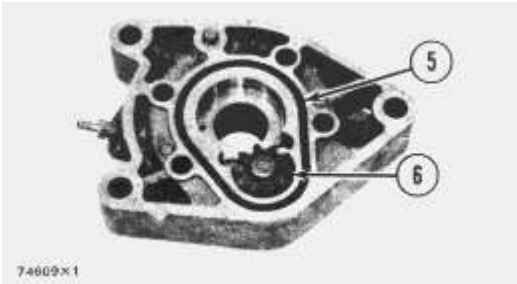

6. Remove idler gear (6) from the body.
7. Remove O-ring seal (5) and the two lip-type seals from the body.

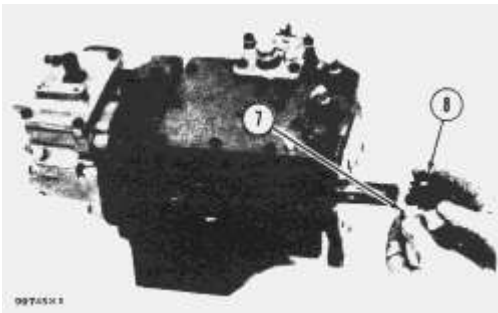

8. Remove drive gear (8) from the shaft.
9. Remove key (7) from the shaft.

Install Fuel Transfer Pump (Later Model Sleeve Metering Fuel System)

Tools Needed		A	B	C
1P529	Handle	1	1	
1P463	Drive Plate	1		
5P318	Drive Plate	1		
5P319	Drive Plate		1	
S1603	Bolt			1
4B4280	Washer			1
4N3371	Washer			1

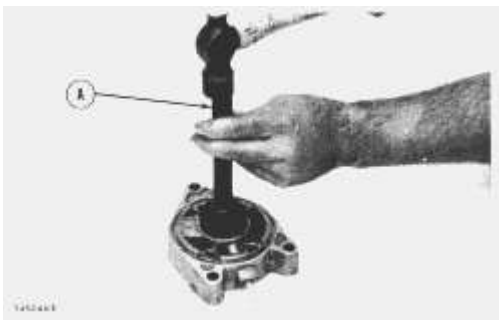

1. Install the inner seal in the body with tool (A). The lip of the seal must be toward the pump gears.
2. Install the outer seal with tool (B). The lip of the seal must be toward the outside.

NOTICE

Always be careful not to cause damage to the machined surface of the pump body.



3. Install the O-ring seal (2) and the idler gear (1) on the body.

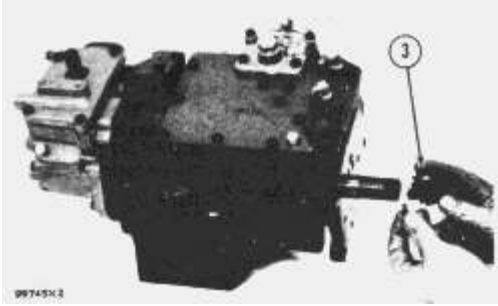

4. Install the key and drive gear (3) on the shaft.

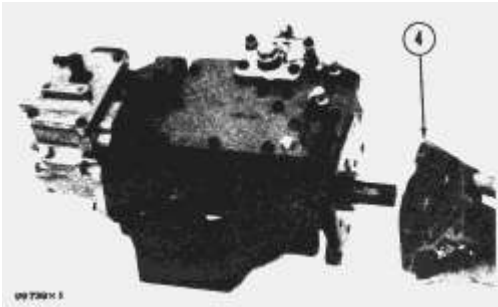

5. Install the body (4) on the housing.

6. Install the bolts that hold the body to the housing.

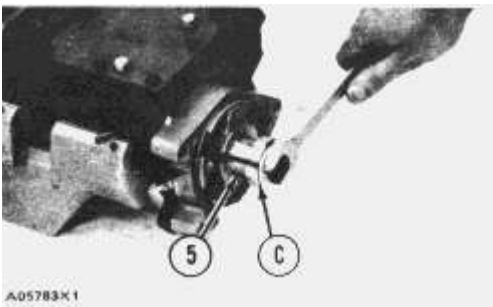

7. Put the sleeve (5) in position on the camshaft.

NOTE: The timing pin must be in the position shown to keep the camshaft from turning during assembly.

8. Install the sleeve on the camshaft with tooling (C).

NOTICE

Do not hit the sleeve with a hammer to install it. This will put end force on the camshaft and cause damage to the other components in the pump housing.

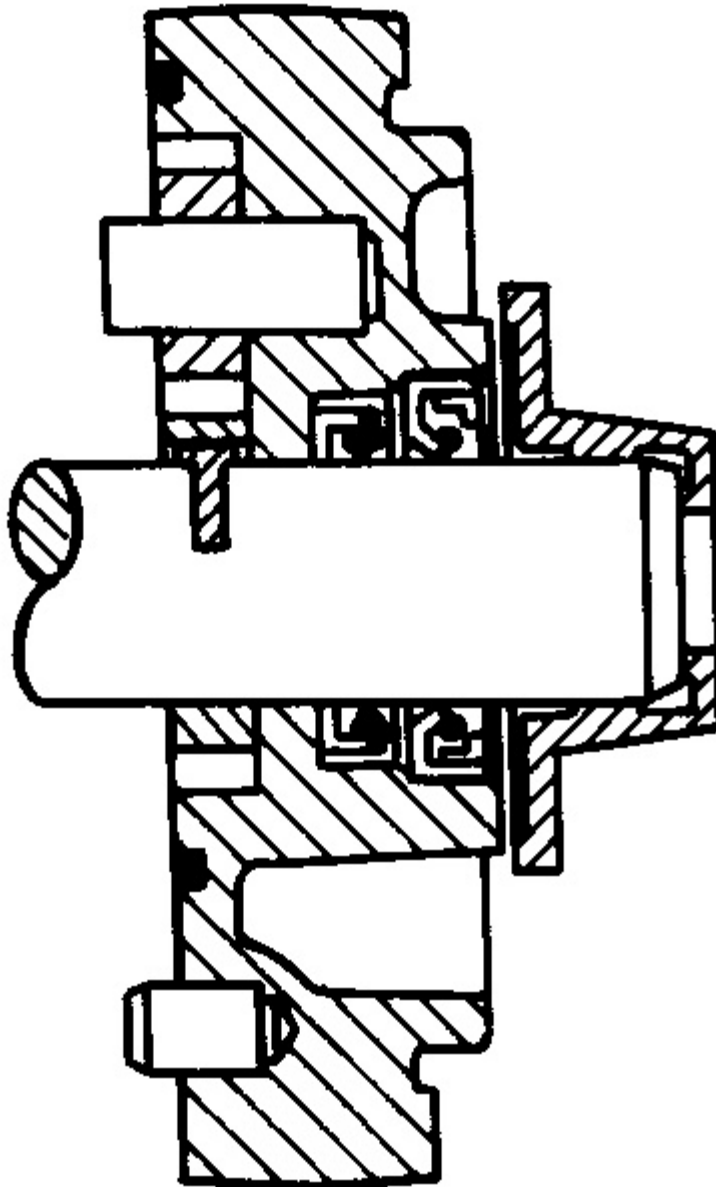

75111x2

9. The end clearance of the camshaft must be 0.58 ± 0.46 mm ($.023 \pm .018$ in.) after sleeve (5) is installed.

end by:

a) install fuel injection pump housing and governor

Product: TRACK-TYPE TRACTOR

Model: D4D TRACK-TYPE TRACTOR 44H

Configuration: D4D TRACTOR 44H01189-01190 (MACHINE) POWERED BY 3304 ENGINE

Disassembly and Assembly D4 TRACTOR ENGINE

Media Number -REG00890-01

Publication Date -01/05/1974

Date Updated -10/10/2001

Fuel Injection Pumps (Later Model Sleeve Metering Fuel System)

SMCS - 1251-11; 1251-12; 1251-15; 1251-16

Remove Fuel Injection Pumps

Tools Needed		A
8S2243	Wrench	1

NOTICE

Before removing the fuel injection pumps, clean the outer surface of the fuel injection pump housing.

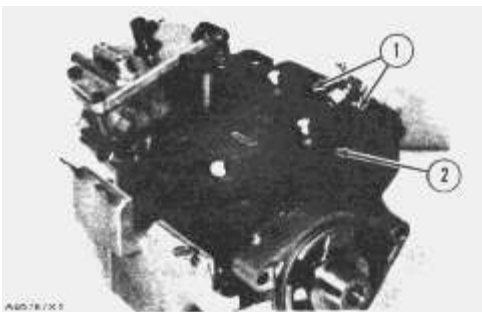

1. Remove the bolts (1) that hold cover (2) in position. Remove the cover.
2. Remove the spring from the bypass valve.

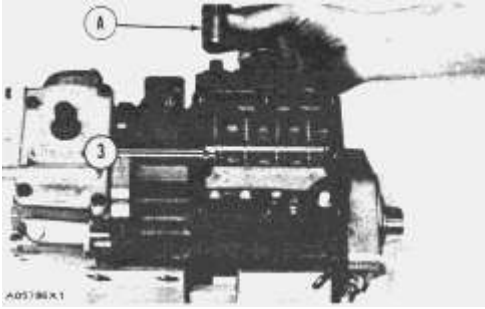

NOTE: Do not loosen screws (3) that hold the levers when removing or installing the fuel injection pumps. If the levers are moved, the fuel pump adjustment will be changed.

3. Remove the fuel injection pumps with tool (A). The sleeve on the plunger will slide off the lever as the fuel injection pump is removed.

Install Fuel Injection Pumps

Tools Needed		A
8S2243	Wrench	1

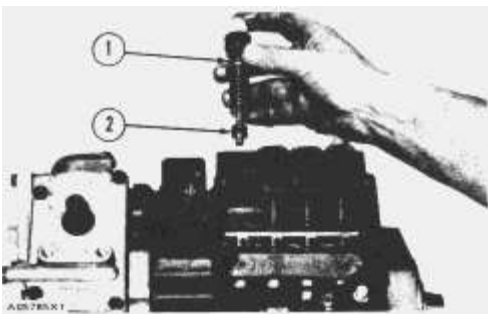

1. Put the fuel injection pump in the bore of the fuel pump housing. Make sure the fuel injection pump (1) is clean and free of dirt and foreign material.

2. The sleeve (2) will be engaged with the lever when installed correctly.

NOTICE

If the levers have been moved on the shaft, the fuel pump adjustment must be made. (See TESTING AND ADJUSTING).

3. Tighten the bushing on the fuel injection pump with tool (A) to a torque of 70 ± 5 lb.ft. (9.7 ± 0.7 mkg).

4. Put the spring on the bypass valve. Install the cover on the fuel injection pump housing. Make sure the spring on the bypass valve is in position in the cover.

Disassemble Fuel Injection Pumps (Later Model Sleeve Metering Fuel System)

start by:

a) remove fuel injection pumps

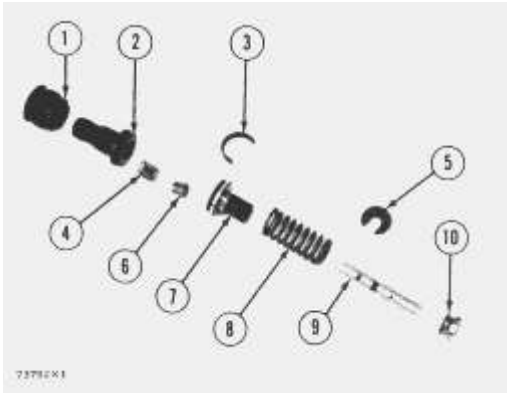

1. Remove bushing (1) from bonnet (2).

2. Remove ring (3) from the bonnet and barrel (7). Remove check valve (6) and spring (4) from the bonnet.

3. Remove spring (8) and washer (5). Remove plunger (9) and sleeve (10).

NOTE: Keep the plunger and sleeve with their respective barrel for installation. Do not use plungers, sleeves, and barrels with other plungers, sleeves and barrels.

Assemble Fuel Injection Pumps (Later Model Sleeve Metering Fuel System)

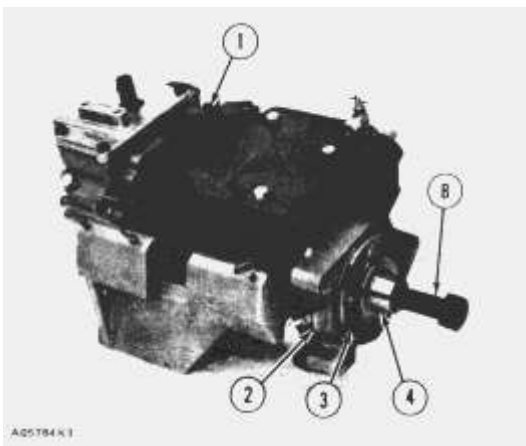

1. Install sleeve (4), plunger (5), spring (2) and washer (3) on barrel (1).

NOTE: Make sure the sleeve and plunger are installed in the original barrel, and the large hole in the plunger is up.

2. Install check valve and spring in the bonnet. Connect the barrel and bonnet and install the ring. Install the bushing on the bonnet.

end by:

a) install fuel injection pumps



Suggest:

For more complete manuals. Please go to the home page.

<https://www.ebooklibonline.com>

If the above button click is invalid. Please download this document first, and then click the above link to download the complete manual.

Thank you so much for reading

Product: TRACK-TYPE TRACTOR

Model: D4D TRACK-TYPE TRACTOR 44H

Configuration: D4D TRACTOR 44H01189-01190 (MACHINE) POWERED BY 3304 ENGINE

Disassembly and Assembly D4 TRACTOR ENGINE

Media Number -REG00890-01

Publication Date -01/05/1974

Date Updated -10/10/2001

Fuel Check Valve And Bypass Valve (Later Model Sleeve Metering Fuel System)

SMCS - 1251-11; 1251-12; 1251-15; 1251-16

Remove Fuel Check Valve And Bypass Valve

NOTICE

Clean the outer surface of the fuel injection pump housing and governor before removing the fuel check valve and bypass valve.

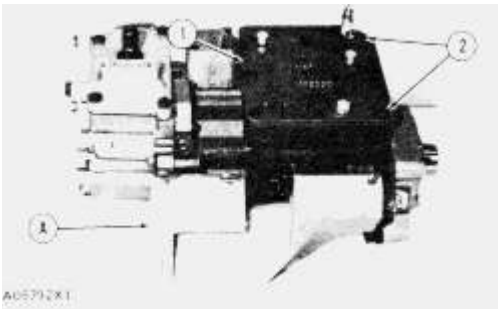

1. Remove the fuel from the fuel injection pump housing. Install the fuel injection pump housing and governor on tool (A).
2. Remove eight bolts (2). Remove cover (1).

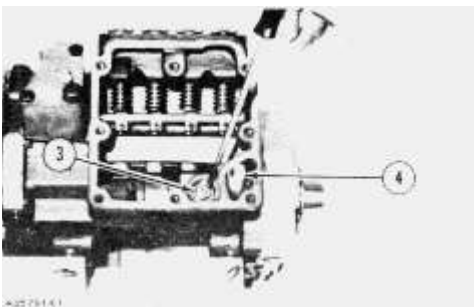

3. Remove check valve (3).
4. Remove spring (4) and the bypass valve.

Install Fuel Check Valve And Bypass Valve

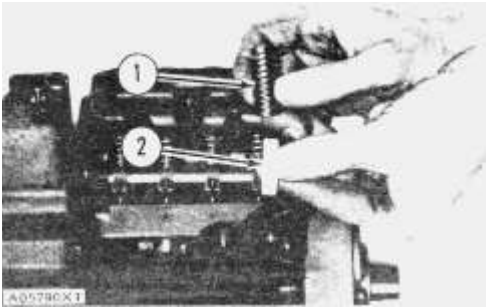

1. Install bypass valve (2) and spring (1) in the fuel injection pump housing.

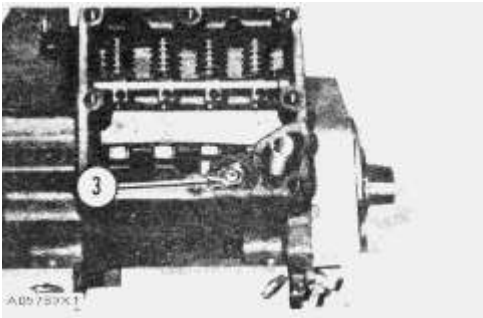

2. Install check valve (3) in the fuel injection pump housing. Make sure the check valve is installed evenly in the fuel injection pump housing.

NOTE: Do not install a check valve that is bent.

3. Put the cover in position on the fuel injection pump housing. Make sure the spring on the bypass valve is in the cover. Install the eight bolts that hold the cover in position.
-

<https://www.ebooklibonline.com>

Hello dear friend!

Thank you very much for reading.

Enter the link into your browser.

The full manual is available for immediate download.

<https://www.ebooklibonline.com>