

Product: TRACK-TYPE TRACTOR

Model: D4C TRACK-TYPE TRACTOR 2CJ

Configuration: D4C AND D4C LGP TRACTORS / POWER SHIFT / 2CJ00001-UP (MACHINE) POWERED BY 3204 ENGINE

Disassembly and Assembly D4B TRACTOR & 935B TRACK-TYPE LOADER VEHICLE SYSTEMS

Media Number -SEN3495-00

Publication Date -01/03/1987

Date Updated -11/10/2001

Hydraulic Control Valves

SMCS - 5054-010; 5054-015; 5054-016

Remove And Install Hydraulic Control Valves

NOTE: The operation is shown on a 931B that has a two valve arrangement with a ROPS. The procedures are the same for the D4B and the 935B.

1. Remove the seat and the seat frame. Drain the oil from the hydraulic tank.

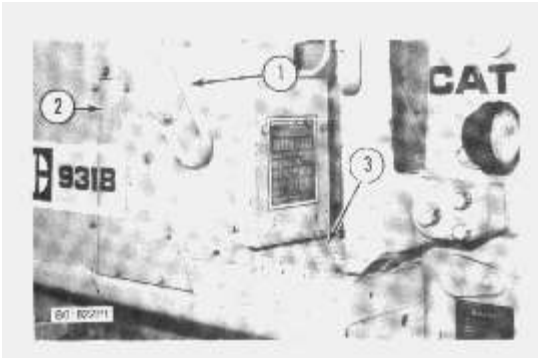

2. Remove handle (1). Remove floor plate (3) and plate assembly (2).

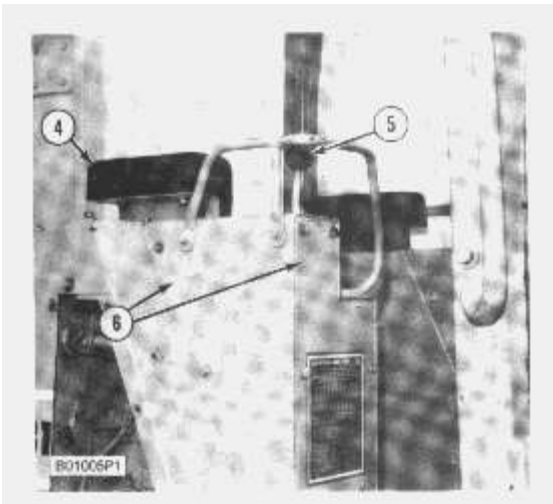

3. Remove knob (5) from the control lever. Remove arm cushion and bracket (4). Remove cover assemblies (6) and the guard as a unit.

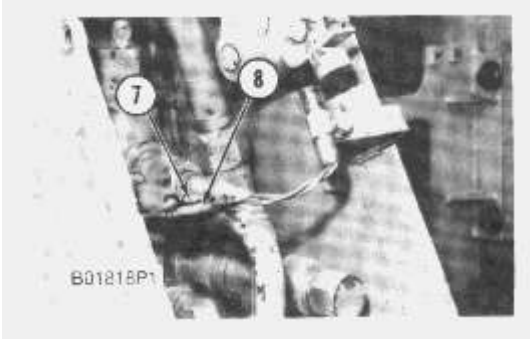

4. Disconnect wires (7) and (8) from the switch.

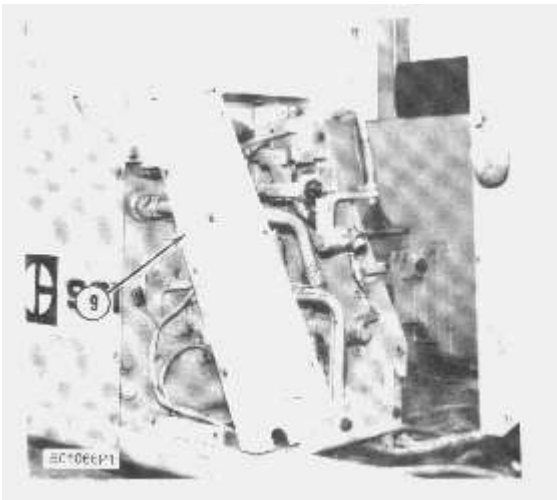

5. Remove cover assembly (9) from the machine.

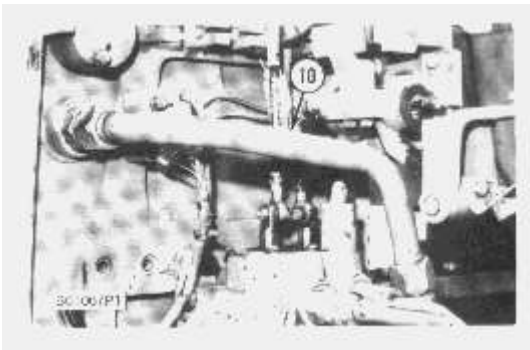

6. Disconnect oil line (10) from the hydraulic tank and the hydraulic control valve and remove it.

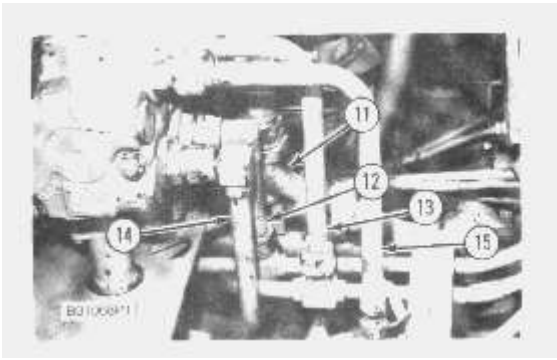

7. Disconnect oil lines (11) and (14) from the hydraulic control valves. Disconnect oil lines (12), (13) and (15) from the tee fittings.

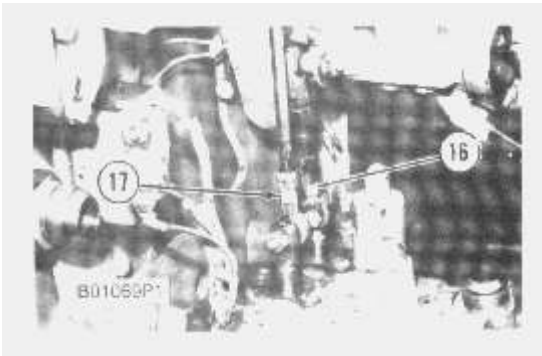

8. Disconnect control linkages (16) and (17) from the hydraulic control valves.

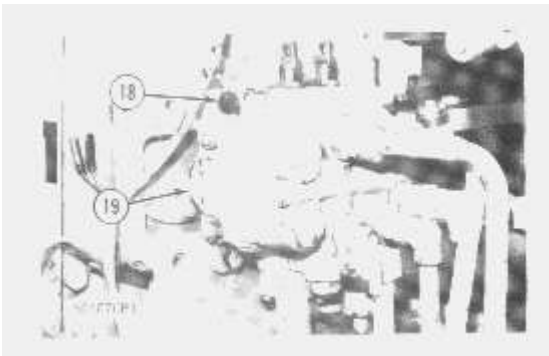

9. Remove bolts (18) that hold the hydraulic control valves in place. Remove hydraulic control valves (19).

NOTE: A machine can be equipped with two, three or four valves. The number of valves needed is controlled by the number of attachments that are on the machine.

NOTE: The following steps are for installation of the hydraulic control valves.

10. Put hydraulic control valves (19) in position and install the bolts (18) that hold it in place.

<https://www.ebooklibonline.com>

Hello dear friend!

Thank you very much for reading.

Enter the link into your browser.

The full manual is available for immediate download.

<https://www.ebooklibonline.com>

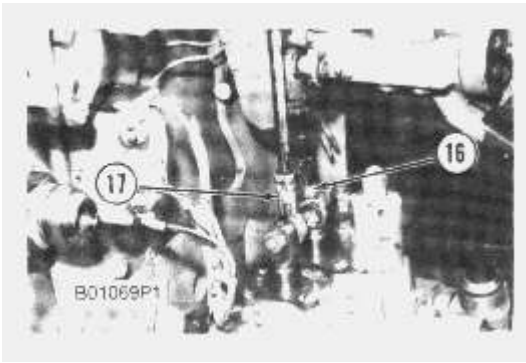

11. Connect control linkages (16) and (17) to the hydraulic control valves.

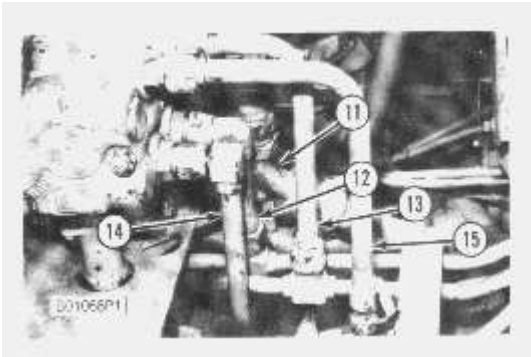

12. Connect oil lines (12), (13) and (15) to the tee fittings. Connect oil lines (11) and (14) to the hydraulic control valves.

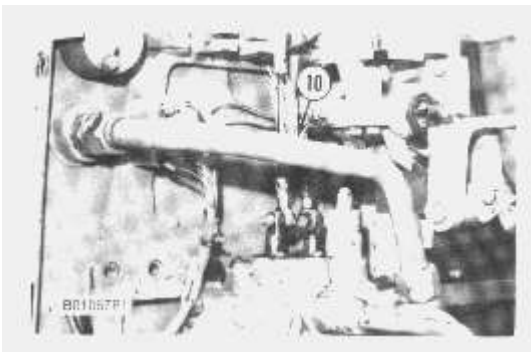

13. Put oil line (10) in place and connect it to the hydraulic control valve and the hydraulic tank.

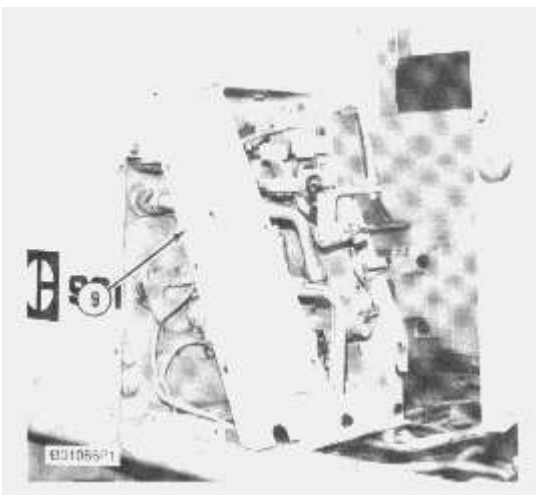

14. Install cover assembly (9).

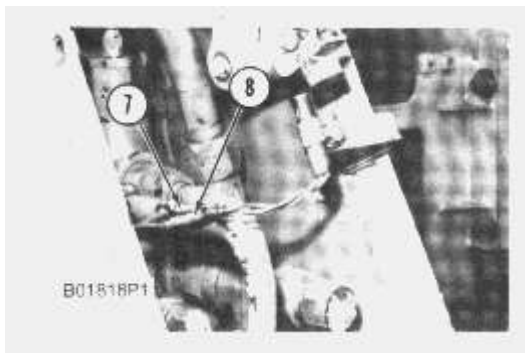

15. Connect wires (7) and (8) to the switch.

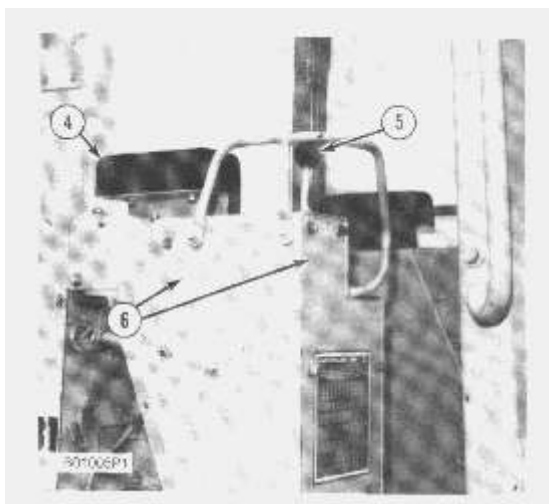

16. Install the guard and cover assemblies (6) as a unit. Install the arm cushion and bracket (4) and knob (5) on the control lever.

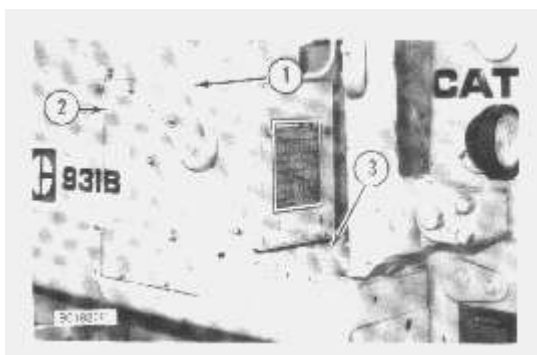

17. Install plate assembly (2). Install the handle (1) and the floor plate (3).

18. Fill the hydraulic tank to the correct level. See the Operation And Maintenance Guide.

Disassemble Hydraulic Control Valves

Start By:

a. remove hydraulic control valves

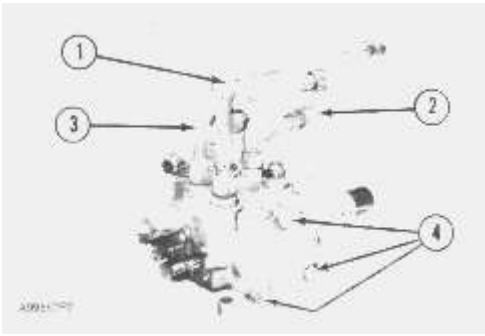

1. Clean the outside of the hydraulic control valve. Put identification on all parts for correct assembly.

NOTE: A machine can be equipped with two, three or four valves. The number of valves needed is controlled by the number of attachments that is on a machine.

NOTE: The valve shown is for a 935B that has a two valve arrangement.

2. Remove tube assemblies (1), (2) and (3). Remove nuts (4) from the rods that hold the hydraulic control valve together.

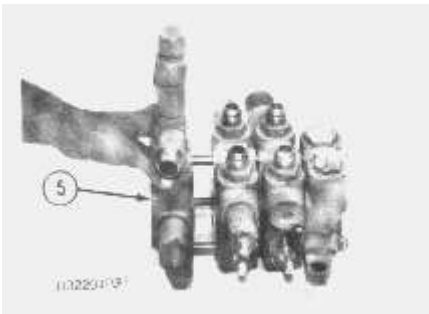

3. Remove inlet oil manifold (5) from the rods.

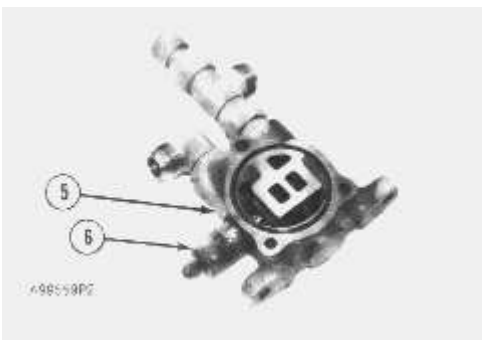

4. Remove O-ring seal from the inlet oil manifold. Remove main relief valve (6) from inlet oil manifold (5).

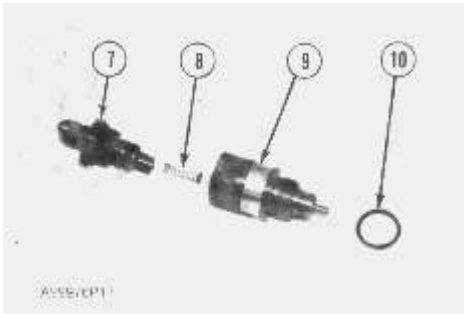

5. Disassemble the main relief valve as follows:

- a. Remove valve body (7) from valve body (9). Remove spring (8).
- b. Remove O-ring seal (10) from valve body (9).

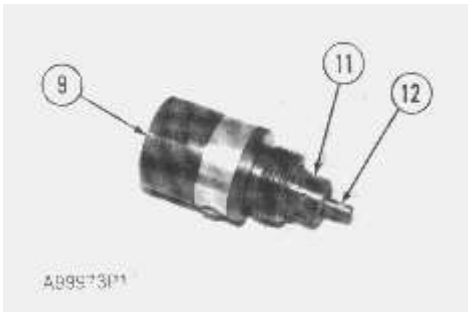

c. Remove plunger (12) and orifice (11) from valve body (9).

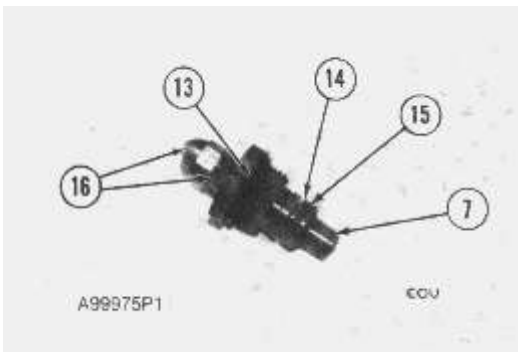

d. Remove O-ring seal (15), ring (14) and O-ring seal (13) from valve body (7).

NOTE: Put a mark on the adjustment screw for the location of the adjustment nuts for correct assembly.

e. Remove adjustment nuts (16) and washers from the adjustment screw.

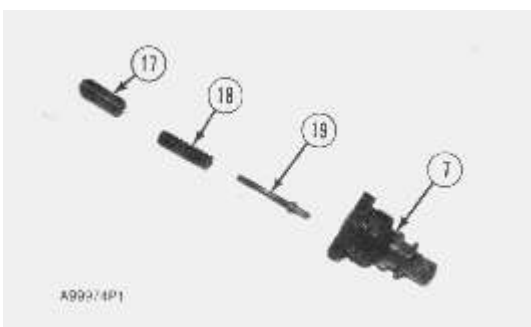

f. Remove adjustment screw (17), spring (18) and plunger (19) from valve body (7).

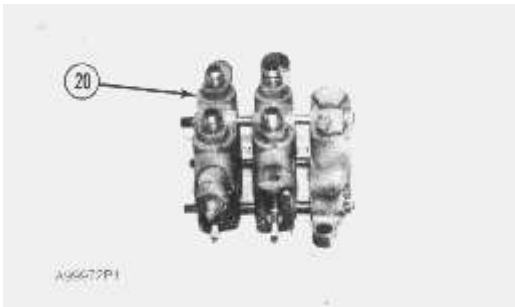

6. Remove tilt control valve (20) from the rods.

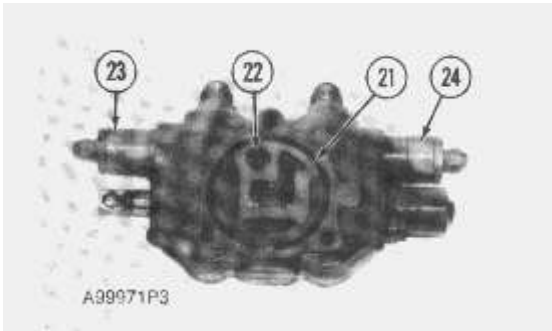

7. Remove O-ring seal (21) from the tilt control valve body. Remove spring (22) and the poppet valve from the tilt control valve body.

NOTICE

Relief valves (23) and (24) are different. Do not mix the parts.

8. Remove relief valves (23) and (24) from the tilt control valve body.

9. Do Step 5 again and disassemble relief valves (23) and (24).

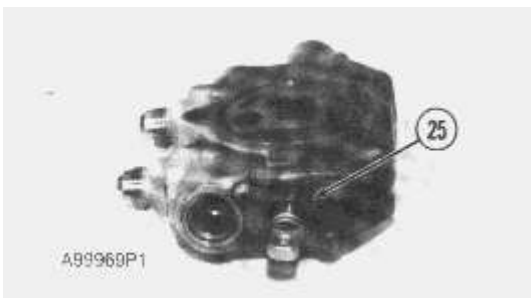

10. Remove plate (25). Remove the wiper seal behind plate (25).

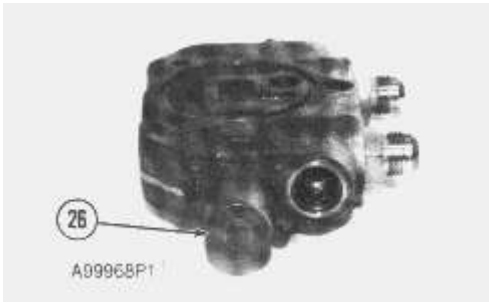

11. Remove cap (26) from the other end of the tilt control valve body.

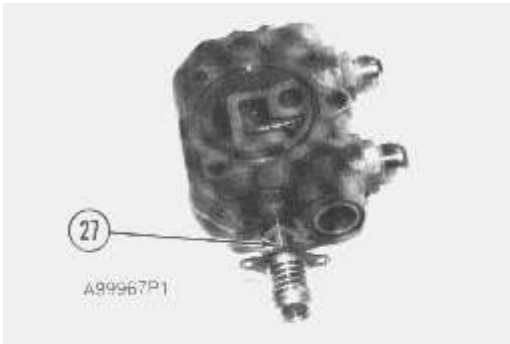

12. Remove tilt control valve spool (27) from the tilt control valve body.

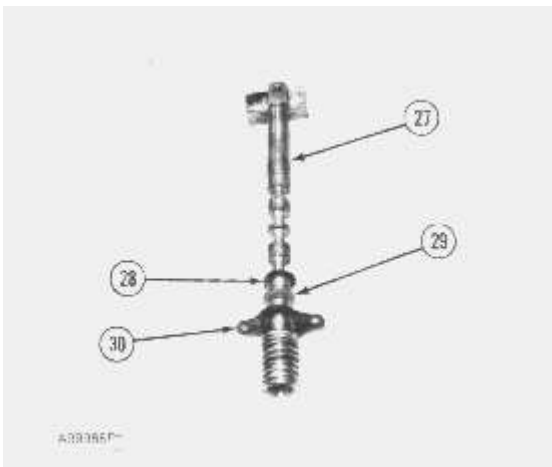

NOTICE

Be extra careful not to cause damage to the valve spool surface.

13. Remove O-ring seal (28), wiper seal (29) and plate (30) from tilt control valve spool (27).

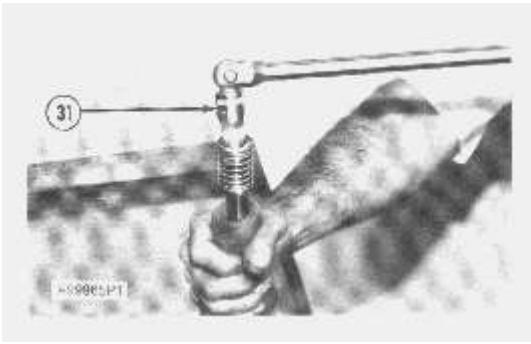

 **WARNING**

Screw (35) holds spring (33) under compression.

14. Put a piece of rubber hose around the tilt control valve spool and carefully put it in a vise. Loosen the screw on the end of the tilt control valve with a drag link socket (31).

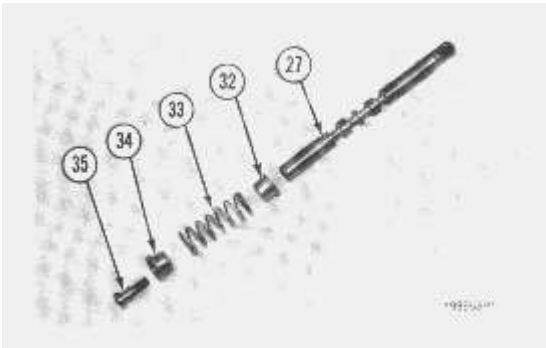

15. Remove screw (35), seat (34), spring (33) and seat (32) from tilt control valve spool (27).

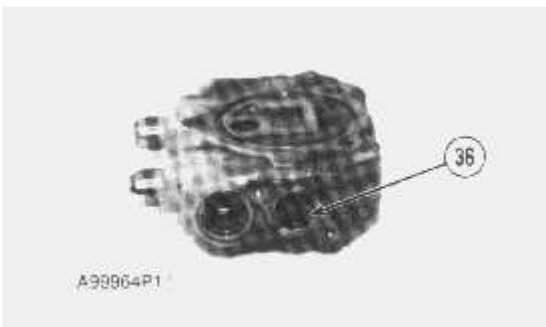

16. Remove O-ring seal (36) from the tilt control valve body.

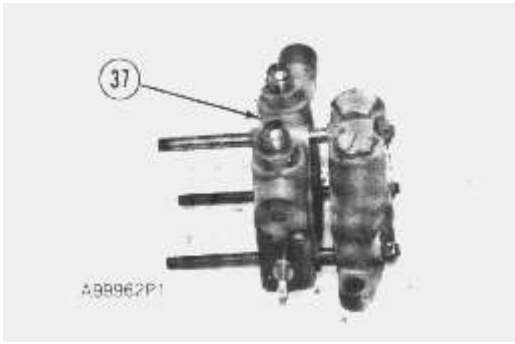

17. Remove lift control valve (37) from the rods.

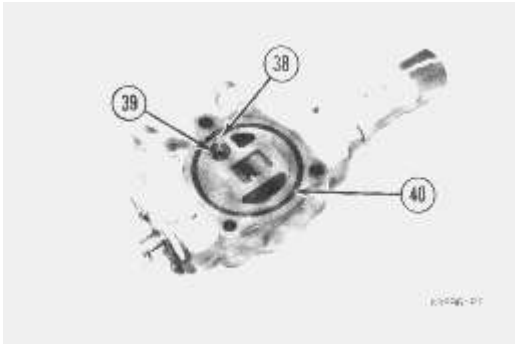

18. Remove spring (38) and poppet valve (39) from the lift control valve body. Remove O-ring seal (40).

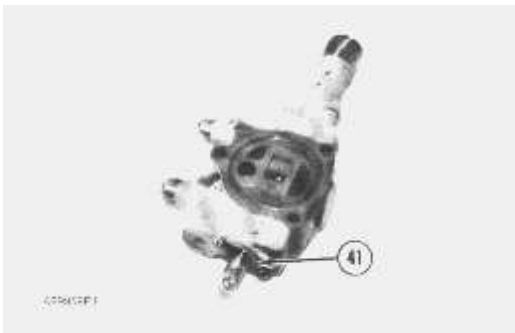

19. Remove plate (41) and the wiper seal behind the plate. Remove O-ring behind the wiper seal.

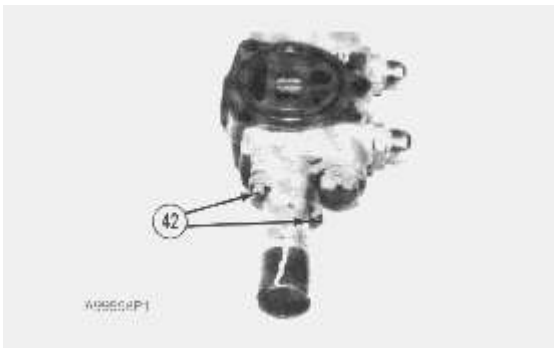

20. Remove two bolts (42) that hold the cap in place.

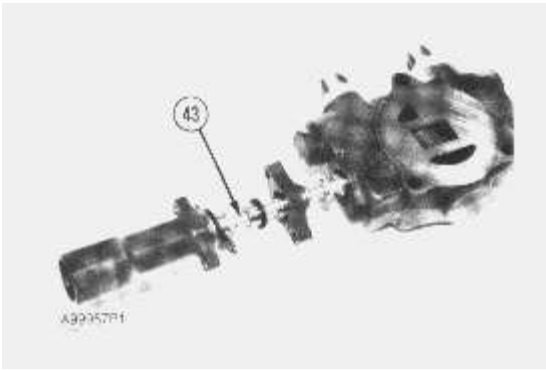

21. Remove lift control valve spool (43) from the lift control valve body.

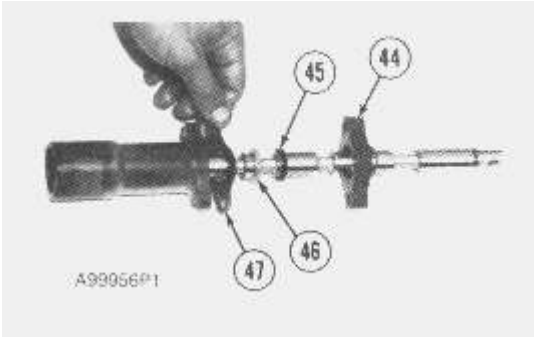

22. Remove spacer (44), O-ring seal (45), wiper seal (46) and plate (47) from the lift control valve spool.

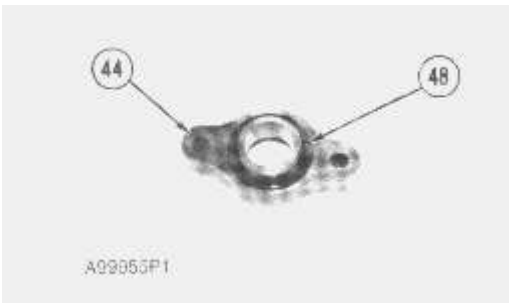

23. Remove O-ring seal (48) from spacer (44).

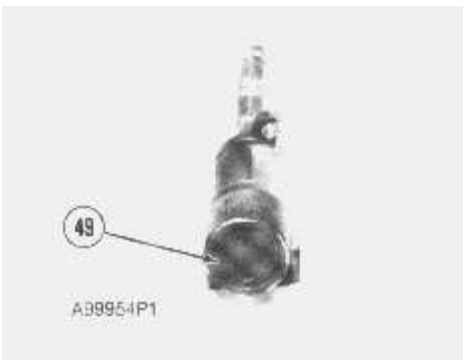

24. Remove ring (49).

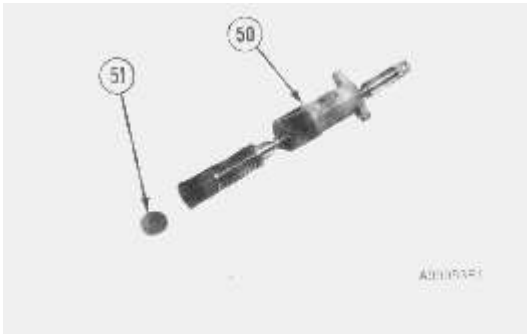

25. Remove plug (51) from cap (50). Remove cap (50) from the lift control valve spool.

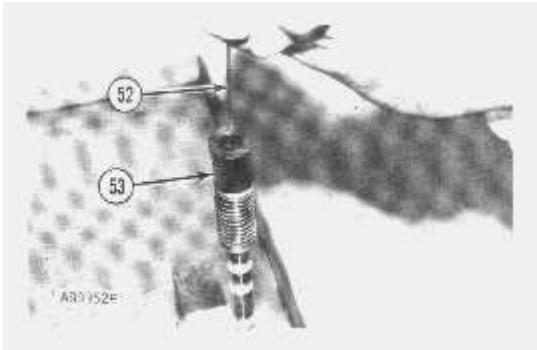

26. Put the flat end of the lift control valve spool in a vise.

 **WARNING**

Sleeve (53) has spring force behind it. Also, be extra careful when sleeve (53) is removed because the balls inside the sleeve are free to fall when the sleeve is removed.

27. Use a small diameter rod (52) and push the ball in the center down. Move sleeve (53) from side to side until two of the four outside balls fall from the groove in the sleeve. Remove sleeve (53) and the five balls from the lift control valve spool.

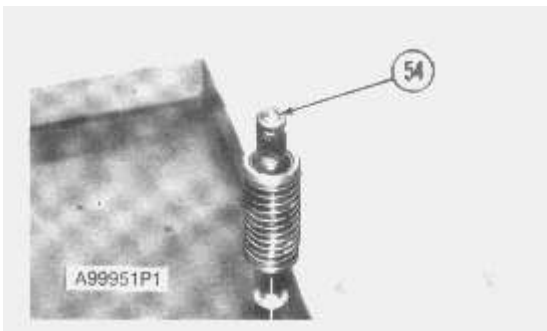

28. Remove spring (54) from the pin.

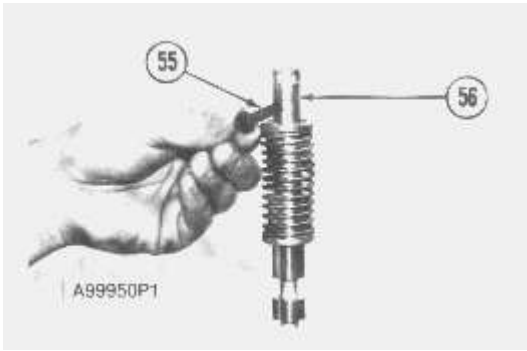

29. Install a 1/4 in. by 3/4 in. bolt (55) in the hole in pin (56) in the end of the lift control valve spool. Install a nut on the bolt.

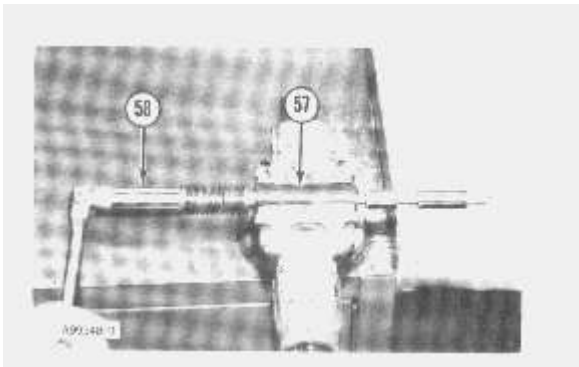

30. Put a piece of rubber hose (57) around the lift control valve spool and carefully put it in a vise.

NOTICE

Be extra careful not to cause damage to the valve spool surface.

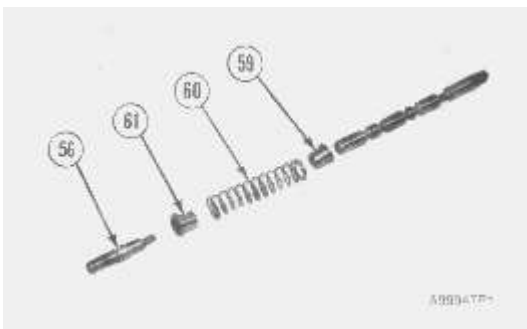

WARNING

Pin (56) holds spring (60) under compression.



Suggest:

For more complete manuals. Please go to the home page.

<https://www.ebooklibonline.com>

If the above button click is invalid. Please download this document first, and then click the above link to download the complete manual.

Thank you so much for reading

31. Use a 1" six point, deep well socket (58) as shown, and remove pin (56), retainer (61), spring (60) and retainer (59) from the lift control valve spool. Remove 1/4" x 3/4" bolt (55) from pin (56).

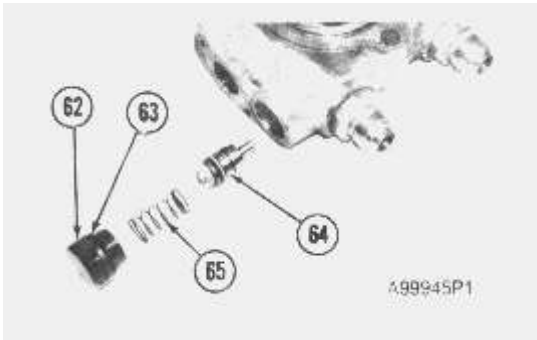

32. Remove plug (62), spring (65) and check valve (64) from the lift control valve body. Remove O-ring seal (63).

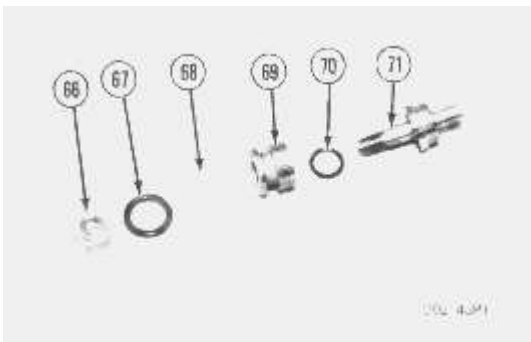

33. Disassemble check valve (64) as follows:

- a. Remove nut (66) from shaft (71).
- b. Remove piston (69) from shaft (71).
- c. Remove O-ring seal (67) and ring (68) from piston (69).
- d. Remove O-ring seal (70).

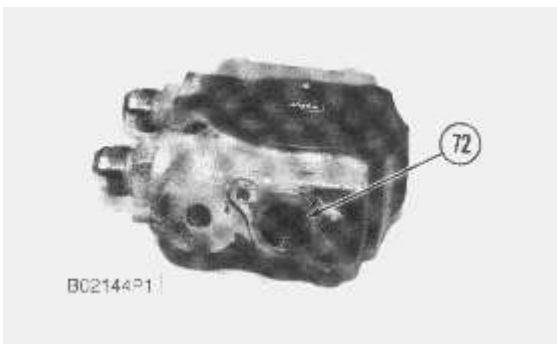

34. Remove O-ring seal (72) from the lift control valve body.

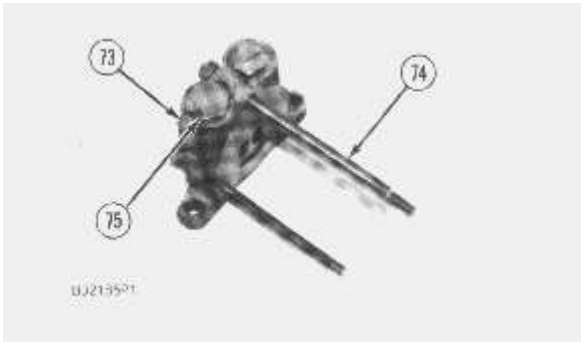

35. Remove rods (74) from the outlet manifold (73). Remove plugs (75) and O-ring seals from the outlet manifold.

Assemble Hydraulic Control Valves

1. Make sure all the parts of the hydraulic control valve are clean. Put clean oil on all of the parts of the valve. Inspect all the parts for damage and make replacements if needed.

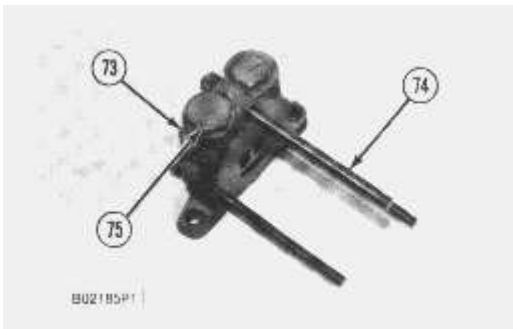

2. Install O-ring seals and plugs (75) in outlet manifold (73).

3. Install rods (74) in the outlet manifold.

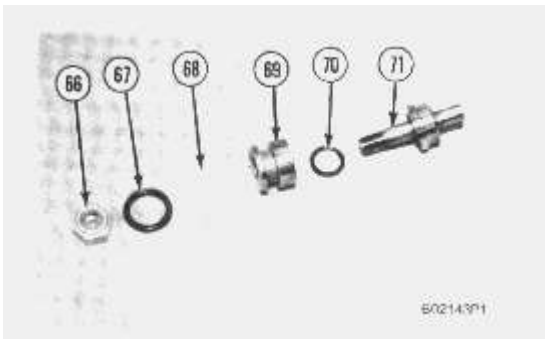

4. Assemble the check valve as follows:

a. Install O-ring seal (70) and piston (69) on shaft (71).

b. Install ring (68) and O-ring seal (67) on piston (69).

c. Install nut (66).

<https://www.ebooklibonline.com>

Hello dear friend!

Thank you very much for reading.

Enter the link into your browser.

The full manual is available for immediate download.

<https://www.ebooklibonline.com>